

# EK-L Series

Precision Bench Scale

EK-15KL/EK-30KL

INSTRUCTION MANUAL



1WMPD4002971

**© 2014 A&D Company, Limited. All rights reserved.**

No part of this publication may be reproduced, transmitted, transcribed, or translated into any language in any form by any means without the written permission of A&D Company, Limited.

The contents of this manual and the specifications of the instrument covered by this manual are subject to change for improvement without notice.

## **COMPLIANCE WITH FCC RULES**

Please note that this equipment generates, uses and can radiate radio frequency energy. This equipment has been tested and has been found to comply with the limits of Class A computing device pursuant to Subpart J of Part 15 of FCC rules. These rules are designed to provide reasonable protection against interference when the equipment is operated in a commercial environment. If this unit is operated in a residential area it may cause some interference and under these circumstances the user would be required to take, at his own expense, whatever measures are necessary to eliminate the interference.

(FCC = Federal Communications Commission in the U.S.A.)

### **Note**

Under some ambient electromagnetic conditions, this equipment may be affected by the electromagnetic interference.

 This is a hazard alert mark.

---

# CONTENTS

---

<b>1. INTRODUCTION</b> .....	3
<b>2. UNPACKING</b> .....	3
<b>3. PART NAMES AND FUNCTIONS</b> .....	4
<b>4. SETTING UP</b> .....	6
4-1. Setting up your scale .....	6
4-2. Power source.....	7
<b>5. OPERATION</b> .....	9
5-1. Turning the power ON and OFF .....	9
5-2. Weighing units .....	10
5-3. Selecting a weighing unit .....	10
5-4. Basic operation .....	11
5-5. Weighing range .....	12
5-6. Counting mode (pcs) .....	13
5-7. Percent mode (%).....	15
<b>6. COMPARATOR</b> .....	16
6-1. Setting example .....	16
<b>7. CALIBRATION</b> .....	18
7-1. Preparation .....	18
7-2. Zero calibration .....	19
7-3. Calibration using a calibration weight .....	19
7-4. Gravity acceleration correction .....	20
<b>8. FUNCTIONS</b> .....	21
8-1. Key operation .....	21
8-2. Entering the function setting mode .....	21
8-3. Setting example .....	22
8-4. Storing weighing units.....	23
8-5. Function list .....	24
<b>9. RS-232C SERIAL INTERFACE</b> .....	26
9-1. Interface specifications .....	26
9-2. Data format .....	28
9-3. Data output mode .....	29
9-4. Command mode .....	29

<b>10. ID NUMBER AND GLP</b> .....	30
10-1. Setting the ID number.....	30
10-2. GLP report .....	31
<b>11. MAINTENANCE</b> .....	35
11-1. Notes on maintenance .....	35
11-2. Error codes .....	35
<b>12. SPECIFICATIONS</b> .....	37
12-1. Specifications.....	37
12-2. Other weighing units.....	37
12-3. Option.....	37
12-4. External dimensions .....	38
<b>GRAVITY ACCELERATION MAP</b> .....	39

---

# 1. INTRODUCTION

---

This manual describes how the EK-L series scale works and how to get the most out of it in terms of performance.

The EK-L series scales have the following features:

- ❑ The EK-15KL is a high resolution electronic scale having a resolution of 1/150,000.
- ❑ The EK-30KL is a dual range scale and each range has a resolution of 1/30,000.
- ❑ The EK-L series scales have a counting function, % function and comparator function.
- ❑ The backlight LCD provides ease of use even in dark locations.
- ❑ RS-232C serial interface is equipped as standard for connection to a printer or personal computer.
- ❑ Using the serial interface, Good Laboratory Practice (GLP) data can be output.
- ❑ The optional sealed lead-acid battery enables use in locations where AC power is not available.

---

## 2. UNPACKING

---

Unpack the package and check that all of the following items are included:

Main unit

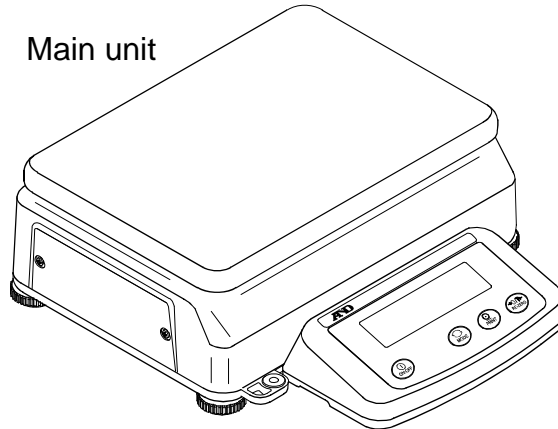

AC adapter

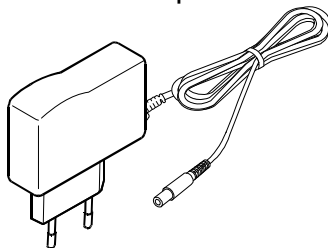

Instruction manual

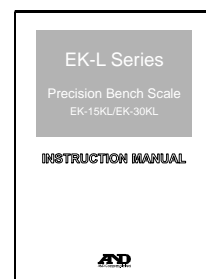

 Please confirm that the AC adapter is correct for your local voltage and receptacle type.

# 3. PART NAMES AND FUNCTIONS

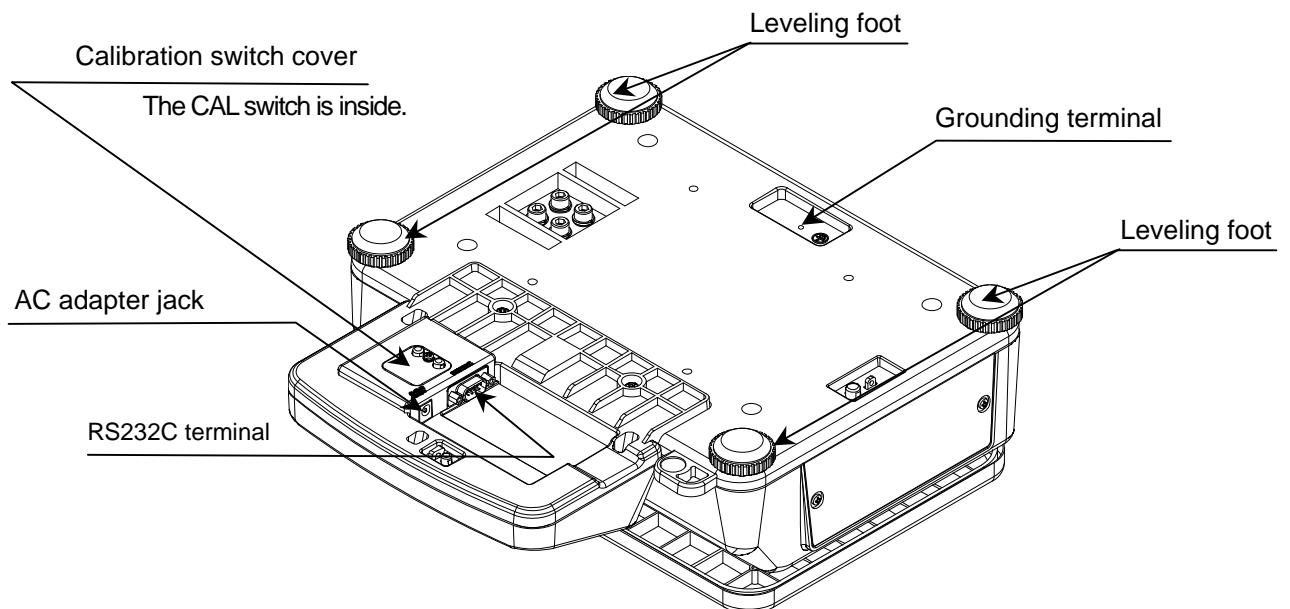
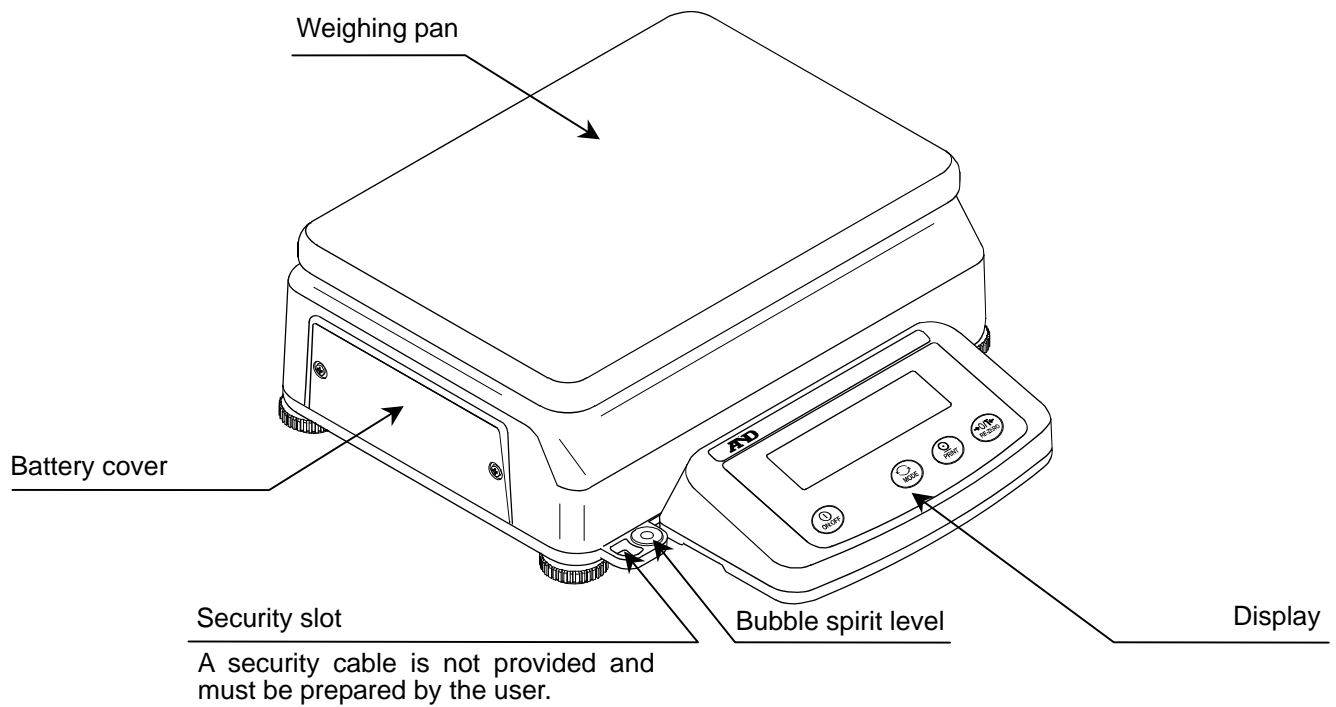

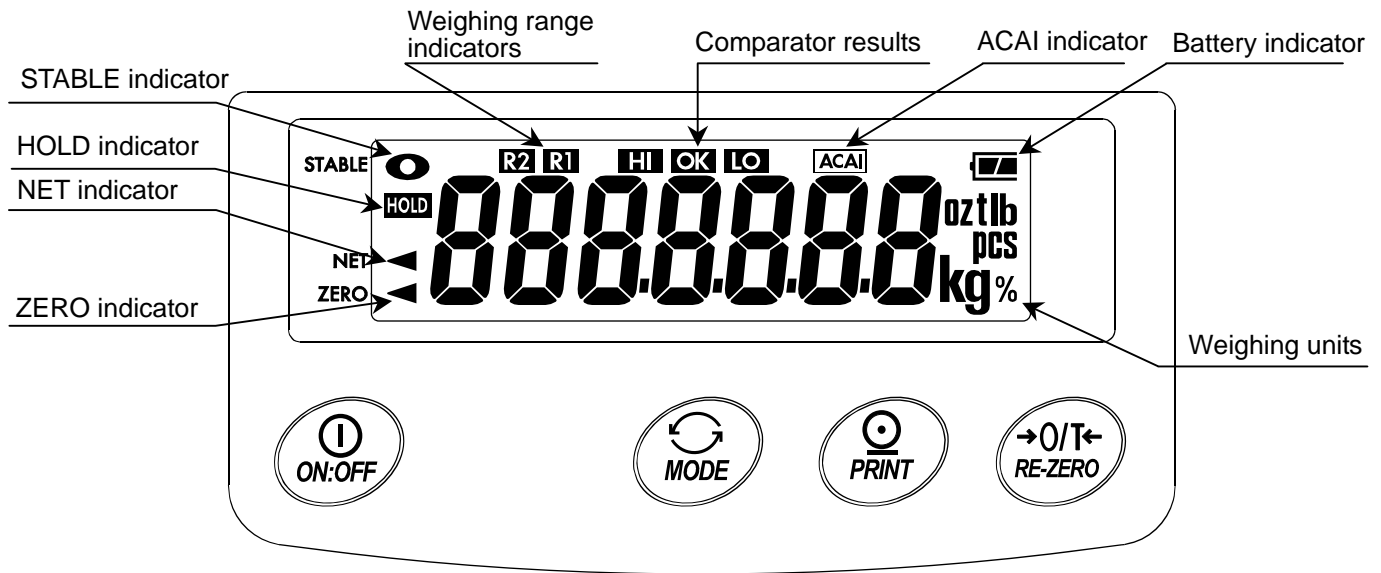

Indicator	Description
STABLE indicator	Turns on when the weight value is stable and is ready to be read.
HOLD indicator	Turns on while the display lock is being performed. Does not turn on when the display lock function is disabled.
NET indicator	Turns on when the net weight is displayed. (The tare operation is in progress.)
ZERO indicator	Turns on when zero is displayed.
Weighing range indicators	Indicates a weighing range. Turns on when the automatic range function is selected for the EK-30KL.
Comparator results	Indicates the results of comparison by turning on <b>HI</b> , <b>OK</b> or <b>LO</b> . Does not turn on when the comparator function is disabled.
ACAI indicator	Turns on or blinks when the ACAI function is being performed. Does not turn on when the ACAI function is disabled.
Weighing units	The weighing units stored in memory turn on.
Battery indicator	Changes as the battery capacity decreases as follows: Full  →  →  Recharging required Does not turn on when the AC adapter is used.

Key	Description
	<b>ON/OFF</b> key Turns the power ON or OFF. When turned ON, the scale is automatically set to zero. (power-on zero).
	<b>MODE</b> key Switches the weighing units.
	<b>PRINT</b> key Outputs the weight data to a printer or personal computer.
	<b>RE-ZERO</b> key Sets the display to zero.
CAL switch	Located under the calibration switch cover. Press and hold the switch to enter the calibration mode.

# 4. SETTING UP

## 4-1. Setting up your scale

1. Adjust the level of the scale using the leveling feet. Use the bubble spirit level to confirm. The bubble should be in the center of the circle.
2. Calibrate the scale before use. See “7. CALIBRATION.”

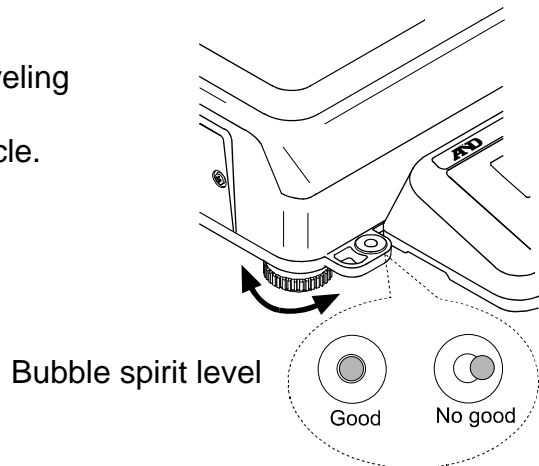

### Scale location

**!** Observe the following to get the most out of your scale and weigh correctly.

- Do not install the scale in locations that are subject to dust, draft, vibration, excessive temperature changes, condensation, or that may have magnetic fields.
- Install the scale on a solid and level surface.
- Do not install the scale in direct sunlight.
- Do not install the scale near heaters or air conditioners.
- Use a stable AC power source.
- Do not install the scale in a place where flammable or corrosive gases present.
- Allow the scale to reach equilibrium with the ambient temperature before use.
- Turn the power ON and warm up the scale for at least 30 minutes before use.
- When the scale is installed for the first time, or the scale has been moved, perform calibration as described in “7. CALIBRATION.”
- If it seems that the scale is being affected by static electricity, ground the scale using the grounding terminal to reduce effects of static electricity.

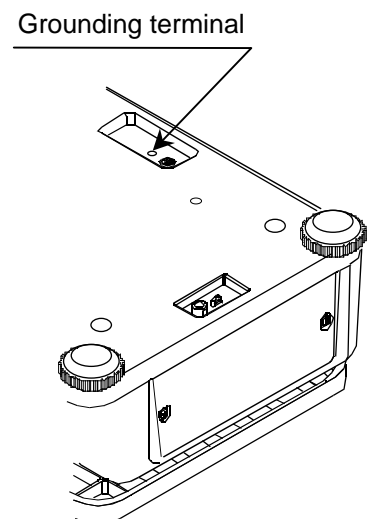



## 4-2. Power source

As the power source, the AC adapter or lead-acid battery is available.

-   The scale remains powered while the AC adapter is connected, even if nothing is shown in the display.
- To ensure stable weighing, keep the scale connected to the power supply using the AC adapter whenever possible.
- There are no negative effects to the scale in keeping it connected to the power supply.
- To ensure accurate weighing, connect the scale to the power supply at least 30 minutes before use.

### Using the AC adapter

Connect the AC adapter to an electrical outlet.

Insert the AC adapter plug into the AC adapter jack located on the underside of the display.

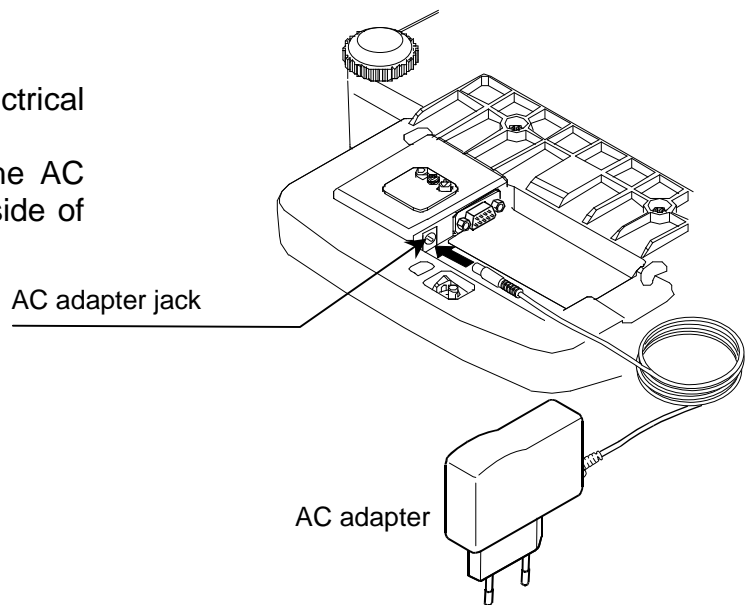

-   Use a stable power source.
- Use the AC adapter provided with the scale.

### Using the sealed lead-acid battery

A commercially available sealed lead-acid battery can be used to operate the scale.

-   Use an NP4-6 battery (6V, 4.0Ah) manufactured by Yuasa Battery Inc.
- The scale can be operated continually for approximately 100 hours on a fully charged battery (at 25°C with backlight always off)
- When disposing of the battery, inquire to the battery manufacturer, supplier or industrial waste disposal company for details on how to correctly dispose of the battery.
- The overall operating hours and battery life vary depending on how the scale is used and the ambient temperature.

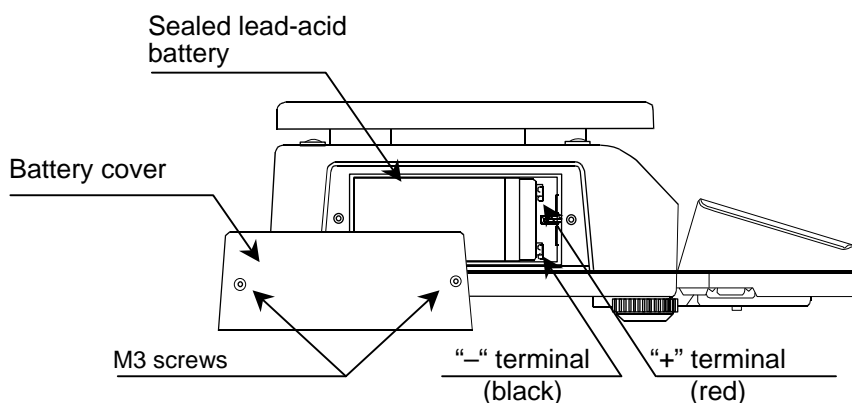

1. Remove the AC adapter plug from the AC adapter jack.
2. Loosen the M3 screws that secure the battery cover and remove the battery cover.
3. Connect the cables in the battery compartment to the battery, the red cable to the + terminal and the black cable to the - terminal.
  - Connecting the battery incorrectly may cause the battery to leak or burst, or may cause fire.**
4. Install the battery into the battery compartment. Replace the battery cover and secure it using the M3 screws removed in Step 2.
5. Press the  ON/OFF key to turn the power ON and confirm that the scale operates properly.
  - The battery indicator is on when the battery is used to operate the scale.**
  - If “Lb” appears in the display, the battery has depleted. Recharge the battery immediately.**

## Recharging the lead-acid battery

1. Connect the cables in the battery compartment to the battery, the red cable to the + terminal and the black cable to the - terminal.
  2. Connect the AC adapter to an electrical outlet. Insert the AC adapter plug into the AC adapter jack.
  3. Recharging starts automatically.
-  **Recharge the battery periodically even if the scale is not used for a long period of time. The battery needs to be recharged at least every three to six months. The battery needs to be recharged more frequently when used in warmer places.**
    - The battery takes approximately 15 hours to fully recharge.**
    - When recharging is complete, remove the AC adapter plug from the AC adapter jack and wait for several minutes before using the battery to operate the scale.**
    - The scale can be used while the battery is being recharged. However, to ensure stable weighing, use the scale after the battery has been fully recharged.**
    - When using a new battery, fully charge the battery before use.**
    - Only use the AC adapter provided with the scale to recharge the battery. Using other adapters may prevent the battery from recharging correctly, and may also cause the battery to leak or burst, or may cause fire.**
    - Recharge the battery in an environment where the temperature is between 0°C and 40°C. The ideal temperature range is 5°C to 35°C.**

---

## 5. OPERATION

---

### 5-1. Turning the power ON and OFF

1. Press the  ON/OFF key to turn the power ON.

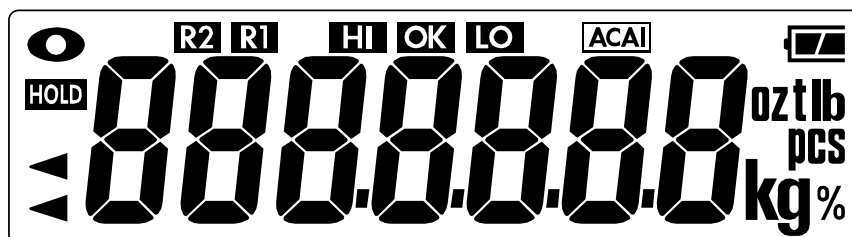

All the display symbols appear as shown above.  
(As for weighing units: Only the units stored in memory are displayed.)

The display turns off except a weighing unit and a decimal point.  
The scale waits for the weight value to become stable, and zero is displayed with the ZERO indicator (power-on zero).

The range for power-on zero is within  $\pm 10\%$  of the weighing capacity around the calibrated zero point.

If the power is turned ON while there is a load beyond this range, the scale is tared to zero and the NET and ZERO indicators turn on.

2. Press the  ON/OFF key to turn the power OFF.

#### Auto power-off function

The auto power-off function automatically turns the power OFF when zero is displayed for approximately 5 minutes.

See "P<sub>o</sub>FF" in "8-5. Function list."

#### Display lock function

The display lock function locks the display temporarily to make the weight value easier to read.

See "H<sub>o</sub>Ld" in "8-5. Function list."

#### LCD backlight function

The LCD backlight turns on when the weight value changes 4d or more (d = minimum display, so, corresponding to four times as great as the minimum display) or any key operation is performed. When the weight value is stable for a certain period of time, the backlight automatically turns off. The backlight can also be set to remain on or off.

See "L<sub>t</sub>UP" in "8-5. Function list."

## 5-2. Weighing units

The most common unit of weight used around the world is the gram, but there is often a need to shift to alternative units specific to the country where the scale is used or to select modes such as counting or percent.

The units and the order they appear in the display are as follows:

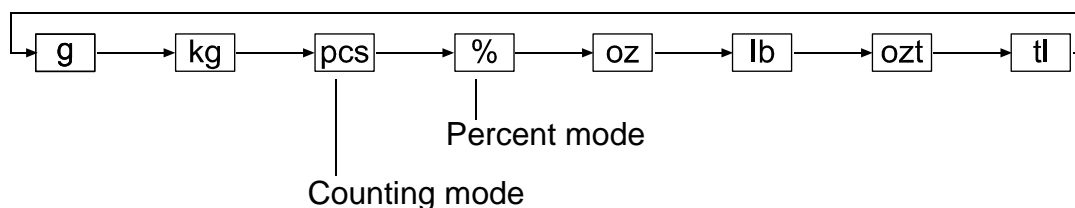

Among the units, those available for the user have been set at the factory before shipping.

The unit can be selected in the function setting mode. The order of the units available is the same as above, while skipping the units that are not available.

- ❑ It is possible to store the weighing units that will be actually used from the units available. It is also possible to specify the unit that will appear first when the power is ON.

For details, see “8-4. Storing weighing units.”

### Conversion table

Units	Name	Conversion to gram
kg	kilogram	1000 g
oz	Ounce (avoir)	28.349523125 g
lb	Pound (UK)	453.59237 g
ozt	Troy ounce	31.1034768 g
tl	Tael (Hong Kong general, Singapore)	37.7994 g

- ❑ The unit “tl (tael)” is for special versions only.

## 5-3. Selecting a weighing unit

Press the MODE key to select a weighing unit.

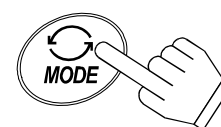

Switches the units available in the order described above

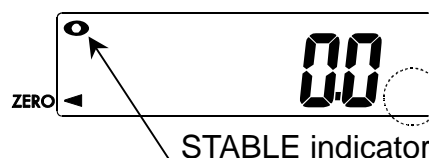

## 5-4. Basic operation

1. Select a weighing unit.
2. When the display doesn't show zero, press the **RE-ZERO** key to set the display to zero.
3. When using a tare (container), place the container on the weighing pan, and press the **RE-ZERO** key to set the display to zero.
4. Place the object to be weighed on the pan or in the container.  
Wait for the STABLE indicator (○) to turn on and read the value.
5. Remove the object from the pan.

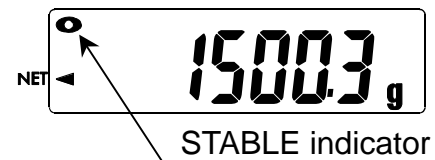
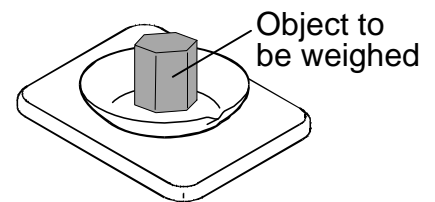
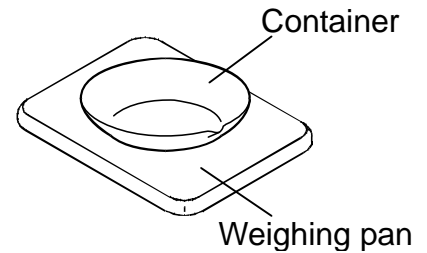

- ❑ The **RE-ZERO** key will zero the scale if the weight value is within  $\pm 2\%$  of the weighing capacity around the power-on zero point. The ZERO indicator turns on. When the weight value exceeds  $+2\%$  of the weighing capacity, the scale is tared to zero and the ZERO and NET indicators turn on.

## Precautions during operation

- ❑ **Make sure that the STABLE indicator is on whenever reading or storing a value.**
- ❑ **Do not use a sharp instrument such as a pencil to press the keys.**
- ❑ **Do not apply a shock or a load to the pan that is beyond the weighing capacity.**
- ❑ **Keep the scale free from foreign objects such as dust or liquid.**
- ❑ **Calibrate the scale periodically to ensure accurate weighing.**  
See "7. CALIBRATION."

## 5-5. Weighing range

Function setting	Description
$r n \bar{0}$	Fixed range <input type="checkbox"/> Fixed to 1/30,000. (R2 range for the EK-30KL)
$r n \bar{1}$	Automatic range function (Only for the EK-30KL) The EK-30KL has two weighing ranges when the automatic range function is selected. The indicator <b>R1</b> or <b>R2</b> turns on to indicate which range the weight value belongs to. <input type="checkbox"/> When the weight value exceeds the maximum value of the R1 range, the weighing range changes automatically to the R2 range. <input type="checkbox"/> When there is nothing on the weighing pan and zero is displayed with the ZERO indicator, the weighing range will automatically be the R1 range. <input type="checkbox"/> When the <b>RE-ZERO</b> key is pressed in the R2 range, the scale is tared to zero and the weighing range changes to the R1 range.

## 5-6. Counting mode (pcs)

The counting mode determines the number of objects in a sample, using the basic sample unit mass.

### Selecting the counting mode

1. Press the **MODE** key to select **PCS**.  
(**PCS**: pieces)



Press and hold

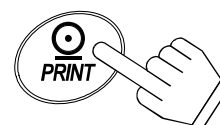
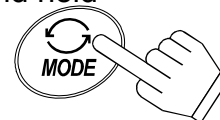

Switches the number of samples



Container

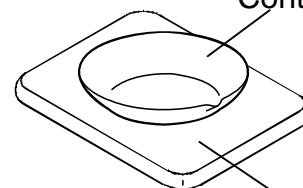

Weighing pan



Confirm the zero display



Samples  
(25 pieces)

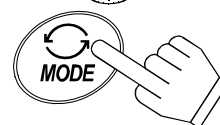
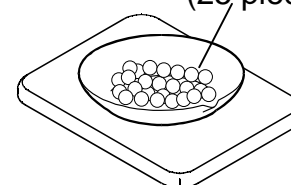

To store



### Storing the sample unit mass

2. Press and hold the **MODE** key to enter the sample unit mass storing mode.

3. Press the **PRINT** key to select the number of samples, 5, 10, 25, 50, or 100.

4. When using a tare (container), place the container on the weighing pan, and press the **RE-ZERO** key. Confirm that the right side of the number of samples shows zero.

5. Place the number of samples specified in Step 3 on the pan. In this example, 25 pieces.

6. Press the **MODE** key to calculate and store the unit mass. Remove the sample. The scale is set to count objects with this unit mass.

- ❑ When a unit mass is too light to store, **Lo** appears in the display for a moment and returns to the former display. When the sample mass is light and the counting error could become large, the scale prompts you to use a larger number of samples. Place the displayed number of samples on the pan and press the **MODE** key to calculate and store the unit mass. See also “Sample quantity error” in “11-2. Error codes.”

### Counting the objects

7. Place the objects to be counted on the pan.

### Counting mode using the ACAI function

ACAI™ (Automatic Counting Accuracy Improvement) is a function that improves the accuracy of the unit mass by increasing the number of samples as the counting process proceeds.

8. After setting the unit mass in Step 6, add a few more samples on the pan. Then, the ACAI indicator turns on. Try to add the same number of samples as displayed. The ACAI indicator does not turn on if overloaded.
9. The ACAI indicator blinks and the scale recalculates the unit mass. Do not touch the scale or samples on the pan until the ACAI indicator turns off.
10. Counting accuracy is improved when the ACAI indicator turns off. Each time the above operation is performed, a more accurate unit mass will be obtained. There is no definite upper limit of ACAI range for the number of samples exceeding 100. Try to add the same number of samples as displayed.

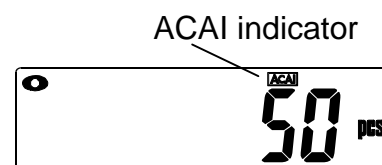



## 5-7. Percent mode (%)

The percent mode displays the weight value in percentage compared with the 100% reference mass.

### Selecting the percent mode

1. Press the **MODE** key to select **%**. (%: percent)



Press and hold

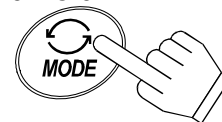

### Storing the 100% reference mass

2. Press and hold the **MODE** key to enter the 100% reference mass storing mode.

3. Press the **RE-ZERO** key to display **100 0%**.



4. Place the sample to be set as the 100% reference mass on the pan.

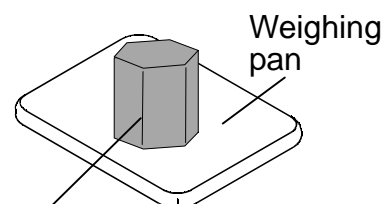

Sample corresponding to the 100% reference mass

5. Press the **MODE** key to store the 100% reference mass. Remove the sample.

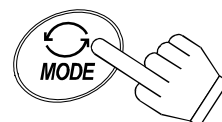

To store



- When the 100% reference mass is too light, **Lo** appears in the display for a moment and returns to the former display.

### Reading the percentage

6. Place the object to be compared with the 100% reference mass on the pan. The displayed percentage is based on the 100% reference mass.

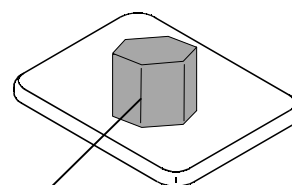

Object to be compared



# 6. COMPARATOR

The results of the comparison are indicated by **HI**, **OK** or **LO** in the display. The comparison is as follows:

$$\mathbf{LO} < \text{Lower limit value} \leq \mathbf{OK} \leq \text{Upper limit value} < \mathbf{HI}$$

Comparison mode (see "[P]" in "8-5. Function list"):

- No comparison (comparator function disabled).
- Compares all data.
- Compares all stable data.
- Compares plus data except those near zero.
- Compares stable plus data except those near zero.
- Compares all data except those near zero.
- Compares all stable data except those near zero.

"Near zero" is a range within  $\pm 4d$  from the zero point in grams or kilograms.  
d = minimum display

The upper limit and lower limit numerical values are common to each of the weighing, counting and percent modes. An example is shown below.

Upper limit value "001010": "101.0 g" "1010 pcs" "101.0%"  
Lower limit value "000990": "99.0 g" "990 pcs" "99.0%"

## 6-1. Setting example

To set "Compares plus data except those near zero."

### Selecting a comparison mode

1. With the power turned OFF, press and hold the **RE-ZERO** key and press the **ON/OFF** key to turn the power ON and enter the function setting mode. **Func** appears.  
(If the comparison mode is already set, press the **MODE** key to go to "Entering the upper and lower limit values.")
2. Press the **PRINT** key to display **PoFF X**.
3. Press the **MODE** key several times to display **[P X]**.
4. Press the **RE-ZERO** key several times to display **[P 3]**.
5. Press the **PRINT** key to store the settings. **[P H,]** appears after **End**.

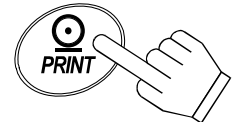

Press several times

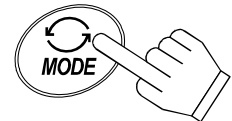

Press several times

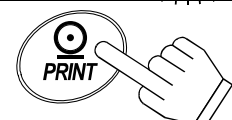

To store

## Entering the upper and lower limit values

6. With **[P H]** displayed, press the **PRINT** key. Enter the upper limit value using the following keys.

**MODE** key To select the digit to change the value. The selected digit blinks.

**RE-ZERO** key To change the value of the selected digit.

CAL switch To switch the sign “+” and “-”.

**PRINT** key To store the value and proceed to the next step.

**[P Lo]** appears after **End**.

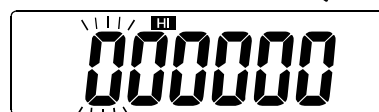
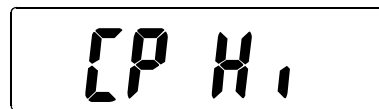

Set using the relevant keys

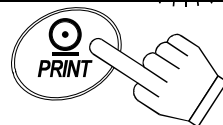

To store

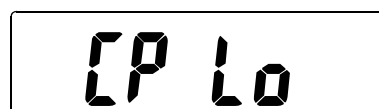

7. With **[P Lo]** displayed, press the **PRINT** key. Enter the lower limit value using the following keys.

**MODE** key To select the digit to change the value. The selected digit blinks.

**RE-ZERO** key To change the value of the selected digit.

CAL switch To switch the sign “+” and “-”.

**PRINT** key To store the value and proceed to the next step.

**Un it** appears after **End**.

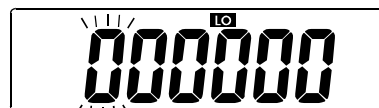

Set using the relevant keys

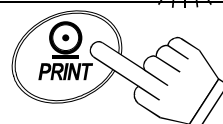

To store



8. Press the **ON/OFF** key to turn the power OFF or press the **RE-ZERO** key to return to the weighing mode.



To return to the weighing mode

# 7. CALIBRATION

This function adjusts the scale for accurate weighing.  
Perform calibration in the following cases.

- When the scale is first used.
- When the scale has been moved.
- When the ambient environment has changed.
- For regular calibration.

Loosen the screws to remove the cover

 The CAL switch is inside

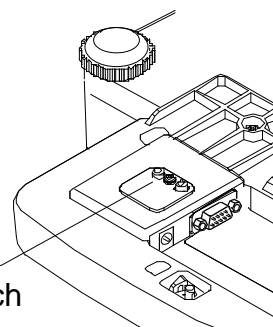

## 7-1. Preparation

- Prepare a calibration weight (conforming to OIML class F1) before starting calibration.
- A calibration weight is not required for performing zero calibration only.
- When a calibration weight is not available, the gravity acceleration correction can be performed to compensate the scale.

1. Turn the power ON and warm up the scale for at least 30 minutes with nothing on the pan.

2. Press and hold the CAL switch until  appears, and release the switch.

 Press and hold the CAL switch

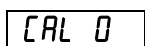
3.  appears.



Release the CAL switch

To change the calibration weight value, proceed to Step 4.

To use the calibration weight value stored in memory or perform zero calibration only, proceed to Step 5.



4. Press the  key. The display shows the calibration weight value in “grams” that is stored in memory. Use the following keys to change the value.



 key To select the digit to change the value. The selected digit blinks.

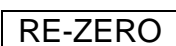

Set using the relevant keys

 key To set the value of the selected digit.

 key To store the value and return to Step 3.

- Use a calibration weight of more than 2/3 of the weighing capacity (of the R2 range for the EK-30KL).
- The calibration weight value is stored in memory even after the power is turned OFF.

## 7-2. Zero calibration

5. With nothing on the pan, press the **RE-ZERO** key to calibrate the zero point. Do not touch the pan during zero calibration.

When the zero calibration is complete, the calibration weight value appears in the display.

- ❑ To perform zero calibration only and finish the procedure, press the **ON/OFF** key to turn the power OFF or press the CAL switch.

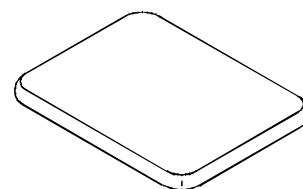

With nothing on the pan



To store



## 7-3. Calibration using a calibration weight

6. Place the calibration weight with the same value as displayed on the pan. Press the **RE-ZERO** key to perform calibration. Do not touch the pan during calibration.

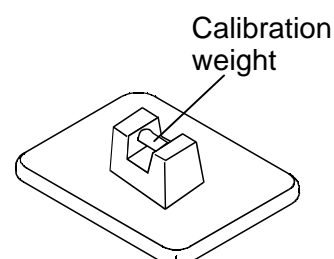

Calibration weight



To store



7. **End** appears.

Remove the weight from the pan.

Press the **ON/OFF** key to turn the power OFF or press the **RE-ZERO** key.

## 7-4. Gravity acceleration correction

When the scale is first used or has been moved to a different place, it should be calibrated using a calibration weight.

But if a calibration weight is not available, the gravity acceleration correction will compensate the scale. Change the gravity acceleration value of the scale to the value of the area where the scale will be used. See the gravity acceleration map appended to the end of this manual.

- Gravity acceleration correction is not required when the scale is calibrated using a calibration weight at the place where the scale will be used.

1. In the weighing mode, press and hold the CAL switch until **CAL** appears, and release the switch.



Press and hold the CAL switch



Release the CAL switch

2. **CAL 0** appears.



3. Press the **MODE** key.

The display shows the gravity acceleration value stored in memory.

Use the following keys to change the value.

**MODE** key To select the digit to change the value. The selected digit blinks.

**RE-ZERO** key To set the value of the selected digit.

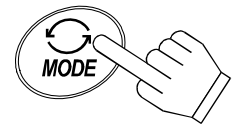

Set using the relevant keys

4. After setting the value, press the **PRINT** key. The value is stored and **CAL 0** appears again.

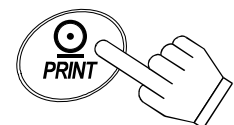





To store



5. If it is necessary to calibrate the scale using a calibration weight, go to Step 3 of "7-1. Preparation." To finish the setting, press the **ON/OFF** key to turn the power OFF or press the CAL switch.

# 8. FUNCTIONS

## 8-1. Key operation

Key	Description
	<b>ON/OFF</b> key Cancels the operation and turns the power OFF.
	<b>MODE</b> key Selects a class and an item.
	<b>PRINT</b> key Proceeds to the selected class. Stores the settings per class and goes to the next class.
	<b>RE-ZERO</b> key Selects a parameter.

## 8-2. Entering the function setting mode

With the power turned OFF, press and hold the **RE-ZERO** key and press the **ON/OFF** key to turn the power ON and enter the function setting mode.

**Func** appears.

Each time the **MODE** key is pressed, the class appears one after another.

See “8-5. Function list.”

**Func**

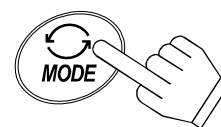

Switches the class

**CP H.**

⋮

### 8-3. Setting example

To set the auto power-off function to “Enabled” and the ACAI function to “Disabled.”

1. With the power turned OFF, press and hold the **RE-ZERO** key and press the **ON/OFF** key to turn the power ON and enter the function setting mode. **Func** appears.



2. Press the **PRINT** key to display **PoFF 0**.

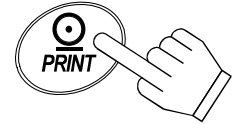

3. Press the **RE-ZERO** key to display **PoFF 1**.



Switches the parameter



4. Press the **MODE** key several times to display **ACA, 1**.

Press several times

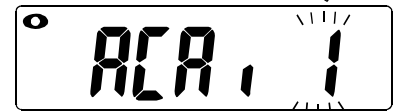
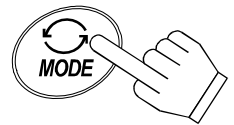

5. Press the **RE-ZERO** key to display **ACA, 0**.



Switches the parameter

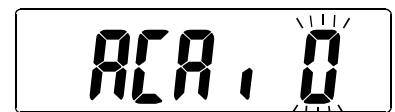

6. Press the **PRINT** key to store the parameters. **CP H, 1** appears after **End**.

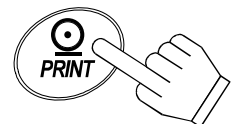

To store



7. Press the **ON/OFF** key to turn the power OFF or press the **RE-ZERO** key.

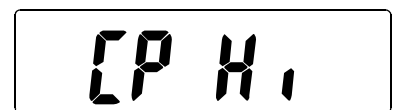



## 8-4. Storing weighing units

It is possible to store the weighing units that will be actually used from the units available. For the units available, see “5-2. Weighing units.”

Select and store the weighing units as described below:

1. With the power turned OFF, press and hold the **RE-ZERO** key and press the **ON/OFF** key to turn the power ON and enter the function setting mode. **Func** appears.



Press several times

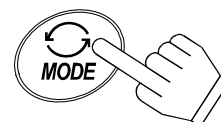

2. Press the **MODE** key several times to display **Unit**.

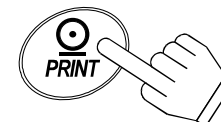
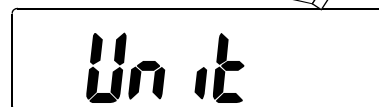

3. Press the **PRINT** key.

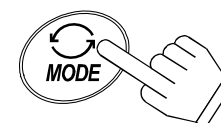
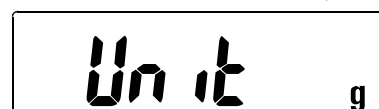

4. Press the **MODE** key to change a weighing unit.

Switches weighing units

5. Press the **RE-ZERO** key to select the weighing unit. The STABLE indicator turns on when the weighing unit has been selected.



To select

6. Repeat Steps 4 and 5 to select all weighing units to be used.

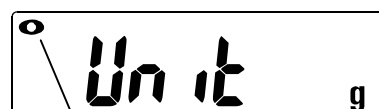

STABLE indicator

7. Press the **PRINT** key to store the units. **id** appears after **End**.

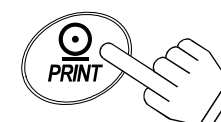

To store



8. Press the **ON/OFF** key to turn the power OFF or press the **RE-ZERO** key.

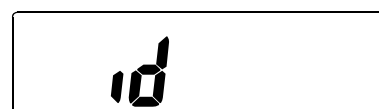

- ❑ When the scale is turned ON, it starts with the weighing unit that was selected first in Step 5.

## 8-5. Function list

Class	Item	Parameter	Description	
<i>Func</i>	<i>PoFF</i> Auto power-off function	◆ 0	Disabled	Turns the power OFF automatically
		1	Enabled	
	<i>rnG</i> Weighing range	0	Fixed to 1/30,000	Switches the range
		◆ 1	Automatic range function (EK-30KL only)	
	<i>HoLd</i> Display lock function	0	Disabled	Locks the display temporarily d=minimum display
		◆ 1	Enabled Disables the function when the change in weight values exceeds ±10d	
		2	Enabled Disables the function when the change in weight values exceeds ±50d	
		3	Enabled Disables the function when the change in weight values exceeds ±100d	
		4	Enabled Disables the function when the change in weight values exceeds ±200d	
	<i>trc</i> Zero tracking	0	Disabled	Tracks the zero shift
		◆ 1	Enabled	
	<i>Pnt</i> Decimal point type	◆ 0	Dot (.)	Selects a decimal point type
		1	Comma (,)	
	<i>CP</i> Comparison mode	◆ 0	No comparison (Comparator function disabled)	Conditions to compare. “Near zero” =range within ±4d from the zero point in grams or kilograms d=minimum display
		1	Compares all data	
		2	Compares all stable data	
		3	Compares plus data except those near zero	
		4	Compares stable plus data except those near zero.	
		5	Compares all data except those near zero	
		6	Compares all stable data except those near zero	
	<i>Prt</i> Data output mode	0	Command mode/stream mode	Auto-print A: + data Auto-print B: +/- data
		◆ 1	Command mode/key mode	
		2	Command/key modes, auto-print A	
3		Command/ key modes, auto-print B		
4		Command mode only		
<i>bPS</i> Baud rate	◆ 0	2400 bps	Selects a baud rate	
	1	4800 bps		
	2	9600 bps		
	3	1200 bps		
<i>btPr</i> Data bits and parity	◆ 0	7 bits, even parity	Selects data bits and parity	
	1	7 bits, odd parity		
	2	8 bits, non parity		

◆ Factory setting

Class	Item	Parameter	Description	
<i>F<sub>unc</sub></i>	<i>PUSE</i> Data output pause	◆ 0	No pause (general equipment)	Interval between continuous data
		1	1.6 seconds (for the AD-8121)	
	<i>inFo</i> GLP output	◆ 0	No output	GLP output format
		1	AD-8121 format	
		2	General format	
	<i>ACAI</i> ACAI function	0	Disabled	If "0" is set, no additional samples required.
		◆ 1	Enabled	
	<i>Min</i> Minimum unit mass	◆ 0	1d	d=minimum display
		1	1/10d	
		2	Total sample mass $\geq 5d^{(*)}$	
	<i>SNPL</i> Number of samples	◆ 0	10 pcs	The number of samples to appear first when entered the sample unit mass storing mode
		1	25 pcs	
		2	50 pcs	
		3	100 pcs	
		4	5 pcs	
	<i>LtUP</i> LCD backlight function	0	Always off	Conditions to turn the backlight on or off. Change in a weight value or key operation turns the backlight on.
		1	Turns off 5 seconds after the STABLE indicator turns on	
		2	Turns off 10 seconds after the STABLE indicator turns on	
		◆ 3	Turns off 30 seconds after the STABLE indicator turns on	
		4	Turns off 60 seconds after the STABLE indicator turns on	
5		Always on		
<i>CPH</i>	Comparator upper limit		Sets the upper limit value	See "6. COMPARATOR"
<i>CPL</i>	Comparator lower limit		Sets the lower limit value	
<i>Unit</i>	Weighing units to be displayed		Sets the weighing units	See "8-4. Storing weighing units"
<i>ID</i>	ID number for GLP output		Sets the ID number	See "10. ID NUMBER AND GLP"

◆ Factory setting

(\*) Even if the weight display is "5d," there may be a range that it is not accepted. This is because the weight display data is rounded off internally.

# 9. RS-232C SERIAL INTERFACE

The scale is a data circuit-terminating equipment (DCE). Connect the scale to a data terminal equipment (DTE) such as a personal computer and external devices using a D-Sub 9-pin straight through cable.

- ❑ The RS-232C serial interface has the following four modes.
  - Stream mode            Outputs data continuously.
  - Key mode                Outputs data when the PRINT key is pressed.
  - Auto-print mode        Outputs data when the auto-print conditions are met.
  - Command mode         Controls the scale using commands from a personal computer.
- ❑ Set the parameters of the data output mode ( $P_r t$ ) and data format ( $b P \zeta$  and  $b t P_r$ ), as necessary.
- ❑ Windows Communication Tools Software (WinCT) to communicate with a personal computer is provided as freeware. Visit the A&D website to download WinCT.

## 9-1. Interface specifications

Transmission system	EIA RS-232C
Transmission form	Asynchronous, bi-directional, half-duplex
Data format	Baud rate: 1200, 2400, 4800, 9600 bps
	Data bits: 7 bits + parity 1 bit (even or odd) or 8 bits (non parity)
	Start bit: 1 bit
	Stop bit: 1 bit
	Code: ASCII
	Terminator: $C_R L_F$ ( $C_R$ : 0Dh, $L_F$ : 0Ah)

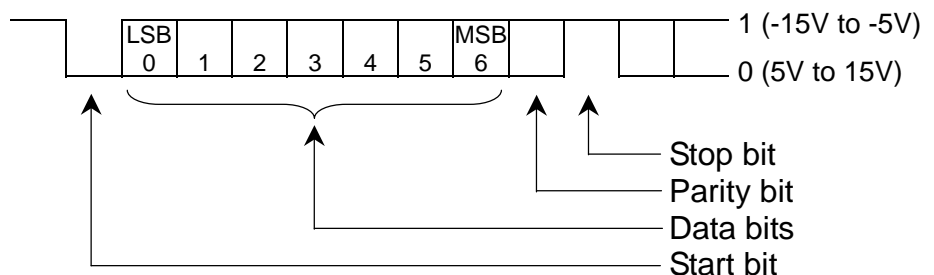

## Pin assignments

Pin No.	Signal name	Direction DCE-DTE	Description
1	–	–	N.C.
2	TxD	→	Transmit data
3	RxD	←	Receive data
4	–	–	N.C.
5	GND	–	Signal ground
6	DSR	→	Data set ready
7	RTS	←	Request to send
8	CTS	→	Clear to send
9	–	–	Used internally

Signal names of the scale side are the same as the DTE side with TxD and RxD reversed.

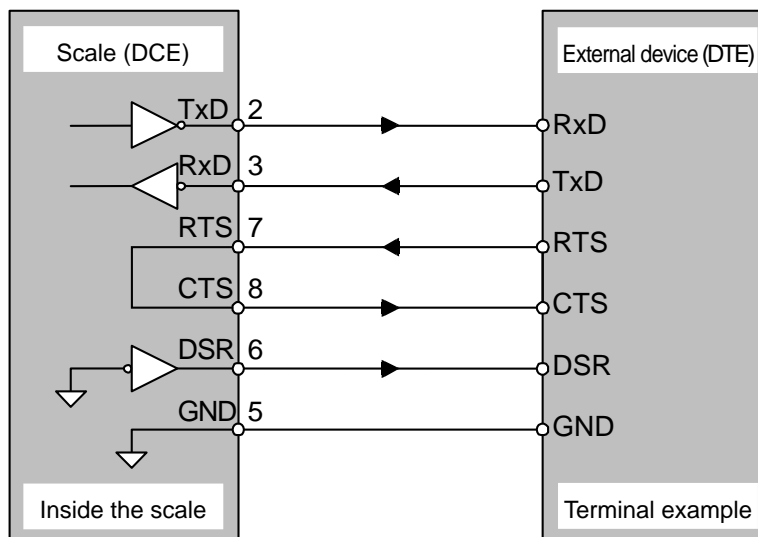

## 9-2. Data format

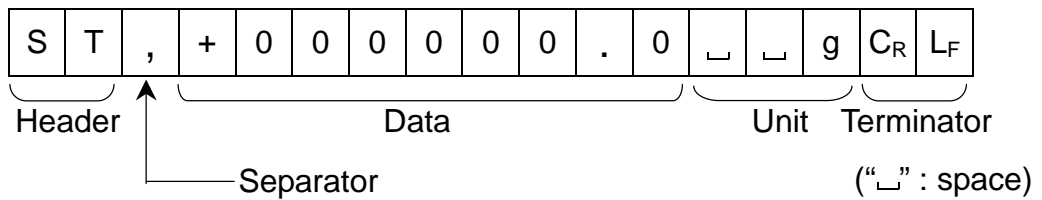

- ❑ A header of two characters indicates the scale condition:  
 ST : Stable weight data (including percentage data)  
 QT : Stable counting data  
 US : Unstable weight data (including counting and percentage data)  
 OL : Out of the weighing range (overloaded)
- ❑ The data is normally 9 digits including a decimal point and a polarity sign.
- ❑ Eight units are available:
  - \_ \_ g : Weight data “gram”
  - \_ k g : Weight data “kilogram”
  - \_ P C : Counting data “pcs”
  - \_ \_ % : Percentage data “%”
  - \_ o z : Weight data “decimal ounce”
  - \_ l b : Weight data “decimal pound”
  - o z t : Weight data “troy ounce”
  - \_ t l : Weight data “tael”
- ❑ The terminator is always C<sub>R</sub>L<sub>F</sub>.
- ❑ Output data example:

Weight data “gram”	S	T	,	+	0	0	1	2	3	4	.	5	_	_	g	C <sub>R</sub>	L <sub>F</sub>
Counting data “pcs”	Q	T	,	+	0	0	0	1	2	3	4	5	_	P	C	C <sub>R</sub>	L <sub>F</sub>
Percentage data “%”	S	T	,	+	0	0	0	1	2	3	.	4	_	_	%	C <sub>R</sub>	L <sub>F</sub>
Out of range “gram” (+)	O	L	,	+	9	9	9	9	9	9	.	9	_	_	g	C <sub>R</sub>	L <sub>F</sub>
Out of range “pcs” (-)	O	L	,	-	9	9	9	9	9	9	9	9	_	P	C	C <sub>R</sub>	L <sub>F</sub>

## 9-3. Data output mode

### Stream mode

Set the data output mode of the function list to "Print 0."

The scale outputs the weight data currently displayed at each display update.

The scale does not output data while it is in the setting mode.

### Key mode

Set the data output mode of the function list to "Print 1, 2 or 3."

When the PRINT key is pressed while the weight data is stable (the STABLE indicator is on), the scale outputs the data. When the data is output, the display blinks one time.

### Auto-print mode A

Set the data output mode of the function list to "Print 2."

The scale outputs the weight data when the data is stable (the STABLE indicator is on) and greater than +4d (of the R1 range for the EK-30KL).

The next output will be performed after the weight data returns below +4d.

### Auto-print mode B

Set the data output mode of the function list to "Print 3."

The scale outputs the weight data when the data is stable (the STABLE indicator is on) and greater than +4d (of the R1 range for the EK-30KL) or less than -4d (of the R1 range for the EK-30KL).

The next output will be performed after the weight data returns between -4d and +4d.

## 9-4. Command mode

In the command mode, the scale is controlled by commands that come from a personal computer.

### Command list

- Command to request the current weight data.

Command QC<sub>R</sub>L<sub>F</sub>

Reply ST,+001234.5\_\_gC<sub>R</sub>L<sub>F</sub>

- Command to zero or tare the scale (same as the RE-ZERO key).

Command ZC<sub>R</sub>L<sub>F</sub>

Reply ZC<sub>R</sub>L<sub>F</sub>

- Command to switch the weighing units (same as the MODE key).

Command UC<sub>R</sub>L<sub>F</sub>

Reply UC<sub>R</sub>L<sub>F</sub>

# 10. ID NUMBER AND GLP

The ID number is used to identify the scale when Good Laboratory Practice (GLP) is used. The following GLP data is output to an AD-8121 printer or a personal computer using the RS-232C interface.

- The results of calibration (“Calibration report”)
- The results of calibration test (“Calibration test report”)
- The “Start block” and “End block” for GLP data

## 10-1. Setting the ID number

1. With the power turned OFF, press and hold the **RE-ZERO** key and press the **ON/OFF** key to turn the power ON and enter the function setting mode. **Func** appears.



Press several times

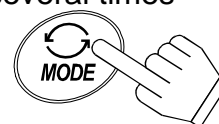

2. Press the **MODE** key several times to display **id**.



3. Press the **PRINT** key. Enter the ID number using the following keys.

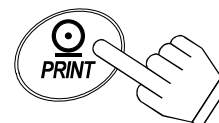

**MODE** key To select the digit to change the value. The selected digit blinks.

**RE-ZERO** key To change the value of the selected digit. See the table below for the “Display character set.”



Set using the relevant keys

4. Press the **PRINT** key to store the settings. **Func** appears after **End**.

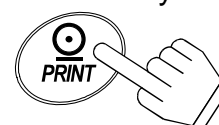

To store



5. Press the **ON/OFF** key to turn the power OFF or press the **RE-ZERO** key.

### Display character set

0	1	2	3	4	5	6	7	8	9	-	_	A	B	C	D	E	F	G	H	I	J	K	L	M	N	O	P	Q	R	S	T	U	V	W	X	Y	Z
0	1	2	3	4	5	6	7	8	9	-	_	A	b	[	d	E	F	G	H	,	j	k	L	ñ	n	o	P	q	r	S	t	U	ü	y		Y	Z

“\_” : Space



## 10-2. GLP report

- ❑ To print the GLP report to an AD-8121B printer, select the function setting “*Info 1*” and “*PUSE 1*” and use MODE 3 of the printer.
- ❑ To output the GLP report to a personal computer, select the function setting “*Info 2*” and “*PUSE 0*.”

### Calibration report

1. Perform calibration according to “7-3. Calibration using a calibration weight.”

2. End appears when the calibration is complete.

End

3. GLP appears and calibration report is output.

°  
GLP

To output the results

4. End appears again. Remove the weight. Press the ON/OFF key to turn the power OFF or press the RE-ZERO key.

End

#### AD-8121 format “*Info 1*”

```

                A & D
MODEL      EK-15KL
S/N       6A6123456
ID        ABCDEF
DATE      2014/04/01
TIME      16:47:39
CALIBRATED(EXT.)
CAL.WEIGHT
           +15000.0 g
SIGNATURE
-----
    
```

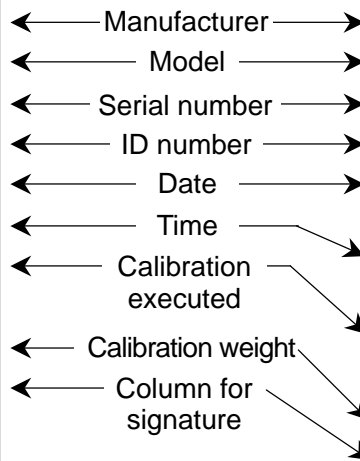

#### General format “*Info 2*”

```

                A_&_D<CRLF>
MODEL_____EK-15KL<CRLF>
S/N_____6A6123456<CRLF>
ID_____ABCDEF<CRLF>
DATE<CRLF>
<CRLF>
TIME<CRLF>
<CRLF>
CALIBRATED(EXT.)<CRLF>
CAL.WEIGHT<CRLF>
_____+15000.0_g<CRLF>
SIGNATURE<CRLF>
<CRLF>
<CRLF>
-----<CRLF>
<CRLF>
<CRLF>
    
```

- ␣ : Space, ASCII 20h
- CR: Carriage return, ASCII 0Dh
- LF: Line feed, ASCII 0Ah

## Calibration test report

The calibration test mode is used to compare a calibration weight with the calibration test data weighed by the scale.

This test does not perform calibration.

1. In the weighing mode, press and hold the **MODE** and **PRINT** keys until **CC** appears, and release the keys.



Release the keys

Pressing and holding the CAL switch will also display **CC** after **CAL**. When **CC** is displayed, release the CAL switch.

The calibration test mode is not available when the function setting “**INF 0**” is selected.

2. **CC 0** appears.

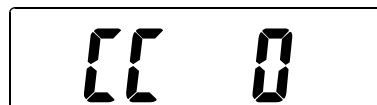

3. If necessary, change the value of the calibration weight as described in Step 4 of “7-1. Preparation.”

4. With nothing on the pan, press the **RE-ZERO** key. The zero point is measured and the measured value with the unit “g” is displayed for a few seconds. Then, the value of the calibration weight is displayed.



Weighing unit



5. Place a weight of the same value as displayed on the pan and press the **RE-ZERO** key to measure it. The measured value with the unit “g” is displayed for a few seconds.



Weighing unit

6. **End** appears.



7. **GLP** appears and calibration test report is output.



To output the results

8. **End** appears again. Remove the weight. Press the **ON/OFF** key to turn the power OFF or press the **RE-ZERO** key.



### AD-8121 format “inf0 1”

```

          A & D
MODEL    EK-15KL
S/N      6A6123456
ID        ABCDEF
DATE     2014/04/01
TIME     17:05:02
CAL. TEST(EXT.)
ACTUAL
          0.0  g
          +15000.1  g
TARGET
          +15000.0  g
SIGNATURE
-----
    
```

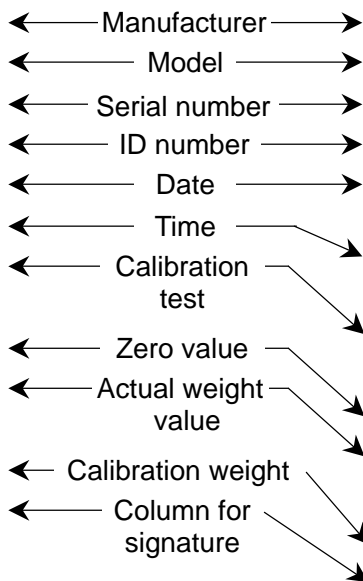

### General format “inf0 2”

```

          A_&_D<CRLF>
MODEL_...EK-15KL<CRLF>
S/N_...6A6123456<CRLF>
ID_...ABCDEF<CRLF>
DATE<CRLF>
<CRLF>
TIME<CRLF>
<CRLF>
CAL. TEST (EXT.) <CRLF>
ACTUAL<CRLF>
          0. 0_...g<CRLF>
          +15000. 1_...g<CRLF>
TARGET<CRLF>
          +15000. 0_...g<CRLF>
SIGNATURE<CRLF>
<CRLF>
<CRLF>
----- <CRLF>
<CRLF>
<CRLF>
    
```

□ : Space, ASCII 20h  
 CR: Carriage return, ASCII 0Dh  
 LF: Line feed, ASCII 0Ah

### Output of “Title block” and “End block”

When weight values are recorded as the GLP report, “Title block” and “End block” are added at the beginning and at the end of a group of weight values.

#### Title block

- In the weighing mode, press and hold the **PRINT** key until **Start** appears, and release the key. The scale outputs the “Title block.”  
The scale returns to the weighing mode after **End**.



Press and hold

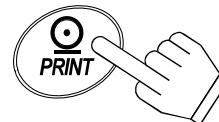

To output “Title block”

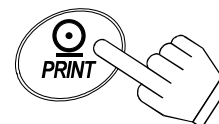

To output the weight values

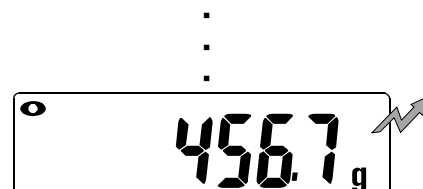

## End block

- Press and hold the **PRINT** key until **rEcEnd** appears, and release the key.  
The scale outputs the "End block."

Press and hold

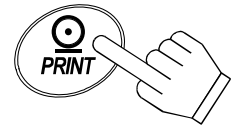

- The scale returns to the weighing mode after **End**.



To output "End block"

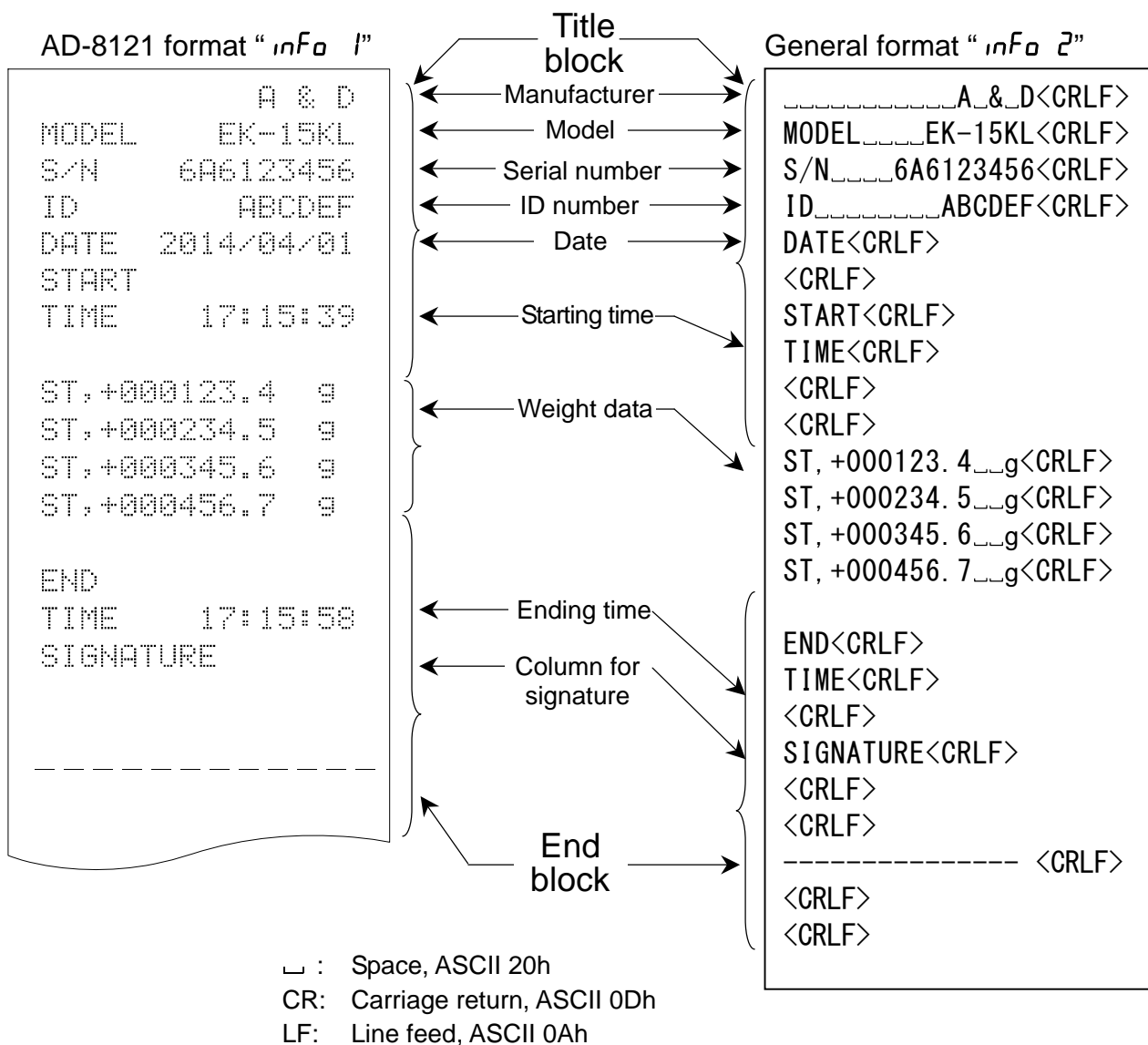

---

# 11. MAINTENANCE

---

## 11-1. Notes on maintenance

- Do not disassemble the scale. Contact your local A&D dealer if your scale needs service or repair.
- Use the original package for transportation.
- Do not use organic solvents to clean the scale. Use a lint free cloth lightly moistened with a mild detergent.

## 11-2. Error codes

### Overload error

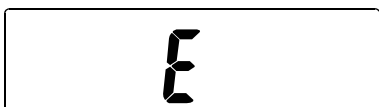

An object beyond the weighing capacity has been placed on the pan.  
Remove the object from the pan.



The scale has detected an excessive load.  
Remove all objects from the pan.  
Confirm that the weighing pan is correctly installed.

### Underload error

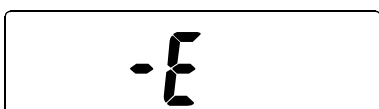

The scale has detected an excessive upward force.  
Check for anything trapped under the edge of the weighing pan.

### Unit mass / 100% reference mass error

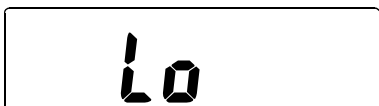

The unit mass / 100% reference mass is too light in the counting / percent mode.

### Sample quantity error



When the sample weight is light and the counting error could become large, the scale prompts you to use a larger number of samples. Place the displayed number of samples on the pan and press the **MODE** key to store the unit mass.

- Pressing the **MODE** key without adding samples is possible, but that will reduce counting accuracy.

When starting with the 100 samples, **100 -** may be displayed if the sample weight is light. If so, press the **MODE** key without adding any samples.

When the function setting "ACR, 0" (ACAI disabled) or "Unit in g" is selected, this error will not appear.

### CAL error

Calibration has been canceled because the calibration weight is too heavy.

Calibration has been canceled because the calibration weight is too light.

Check the weighing pan and the calibration weight. Press the **ON/OFF** key to turn the power OFF or press the CAL switch to return to the weighing mode.

### Low battery

The battery (OP-02) has depleted. Stop using the scale immediately and recharge the battery, or use the AC adapter to operate the scale.

### AC adapter error

The output voltage of the AC adapter is too high. Check if the AC adapter is correct for your local voltage and receptacle type.

### Stability error

The weight value is not stable and the scale cannot display it. Prevent vibration and drafts from affecting the scale. Press the **MODE** key to return to the weighing mode.

### Internal error (# = 2,3,4 or 5)

The scale detects an error in the internal processing. Remove all objects from the pan. Turn the power OFF and ON again. If the error persists, request service.

**If you cannot resolve an error or other errors occur, request service from the store where you purchased the scale or from your local A&D dealer.**

# 12. SPECIFICATIONS

## 12-1. Specifications

MODEL	EK-15KL	EK-30KL	
Weighing capacity	15 kg	3 kg	30 kg
Minimum display "d"	0.1 g	0.1 g	1 g
Number of samples	5, 10, 25, 50 or 100 pieces		
Maximum count *)	150,000 pieces	300,000 pieces	
Minimum unit mass *)	0.1 g	0.1 g	
Minimum % display	0.1 %	0.1 %	
Repeatability (Standard deviation)	0.3 g	0.3 g	1 g
Linearity	±0.6 g	±0.6 g	±1 g
Sensitivity drift	±20 ppm / °C (10°C to 30°C / 50°F to 86°F)		
Display	7 segment LCD with backlight (Character height 22 mm)		
Display update	Approximately 10 times per second		
Operating temperature range/ humidity	10°C to 40°C / 14°F to 104°F Less than 85% R.H. (non-condensing)		
Power supply	AC adapter or optional lead-acid battery		
Battery operating hours	Approximately 100 hours (at 25°C with backlight off)		
Weighing pan size	300 mm x 210 mm		
Mass (approximately)	4.2 kg	4.9 kg	
Calibration weight (factory setting)	15 kg	30 kg	

\*) In case of "Un in 0" (factory setting)

## 12-2. Other weighing units

MODEL		EK-15KL	EK-30KL	
oz.	Weighing capacity	529.110	105.820	1058.20
	Minimum display	0.005	0.005	0.05
lb	Weighing capacity	33.0690	6.6140	66.140
	Minimum display	0.0005	0.0005	0.005
ozt	Weighing capacity	482.260	96.450	964.50
	Minimum display	0.005	0.005	0.05
tl	Weighing capacity	396.830	79.365	793.65
	Minimum display	0.005	0.005	0.05

☐ The unit "tl (Hong Kong General / Singapore)" is for special versions only.

## 12-3. Option

OP-02: Sealed lead-acid battery (Recommended model: YUASA NP4-6)

## 12-4. External dimensions

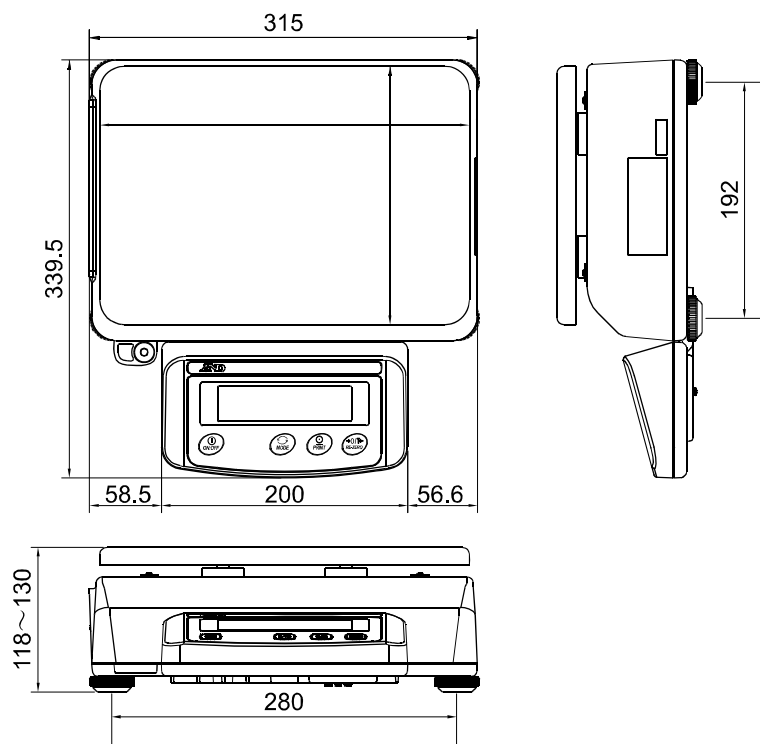

Unit: mm



# GRAVITY ACCELERATION MAP

## Values of gravity at various locations

Amsterdam	9.813 m/s <sup>2</sup>	Manila	9.784 m/s <sup>2</sup>
Athens	9.800 m/s <sup>2</sup>	Melbourne	9.800 m/s <sup>2</sup>
Auckland NZ	9.799 m/s <sup>2</sup>	Mexico City	9.786 m/s <sup>2</sup>
Bangkok	9.783 m/s <sup>2</sup>	Milan	9.807 m/s <sup>2</sup>
Birmingham	9.813 m/s <sup>2</sup>	Moscow	9.816 m/s <sup>2</sup>
Brussels	9.811 m/s <sup>2</sup>	New York	9.802 m/s <sup>2</sup>
Buenos Aires	9.797 m/s <sup>2</sup>	Oslo	9.819 m/s <sup>2</sup>
Cape Town	9.796 m/s <sup>2</sup>	Ottawa	9.807 m/s <sup>2</sup>
Chicago	9.803 m/s <sup>2</sup>	Paris	9.810 m/s <sup>2</sup>
Copenhagen	9.816 m/s <sup>2</sup>	Rio de Janeiro	9.788 m/s <sup>2</sup>
Cyprus	9.797 m/s <sup>2</sup>	Rome	9.803 m/s <sup>2</sup>
Frankfurt	9.811 m/s <sup>2</sup>	San Francisco	9.800 m/s <sup>2</sup>
Glasgow	9.816 m/s <sup>2</sup>	Singapore	9.780 m/s <sup>2</sup>
Havana	9.788 m/s <sup>2</sup>	Stockholm	9.819 m/s <sup>2</sup>
Helsinki	9.819 m/s <sup>2</sup>	Sydney	9.796 m/s <sup>2</sup>
Jakarta	9.781 m/s <sup>2</sup>	Taichung	9.789 m/s <sup>2</sup>
Kolkata (Calcutta)	9.788 m/s <sup>2</sup>	Taipei	9.790 m/s <sup>2</sup>
Kuwait	9.793 m/s <sup>2</sup>	Tokyo	9.798 m/s <sup>2</sup>
Lisbon	9.801 m/s <sup>2</sup>	Vancouver, BC	9.810 m/s <sup>2</sup>
London (Greenwich)	9.812 m/s <sup>2</sup>	Washington DC	9.801 m/s <sup>2</sup>
Los Angeles	9.797 m/s <sup>2</sup>	Wellington NZ	9.803 m/s <sup>2</sup>
Madrid	9.802 m/s <sup>2</sup>	Zurich	9.808 m/s <sup>2</sup>

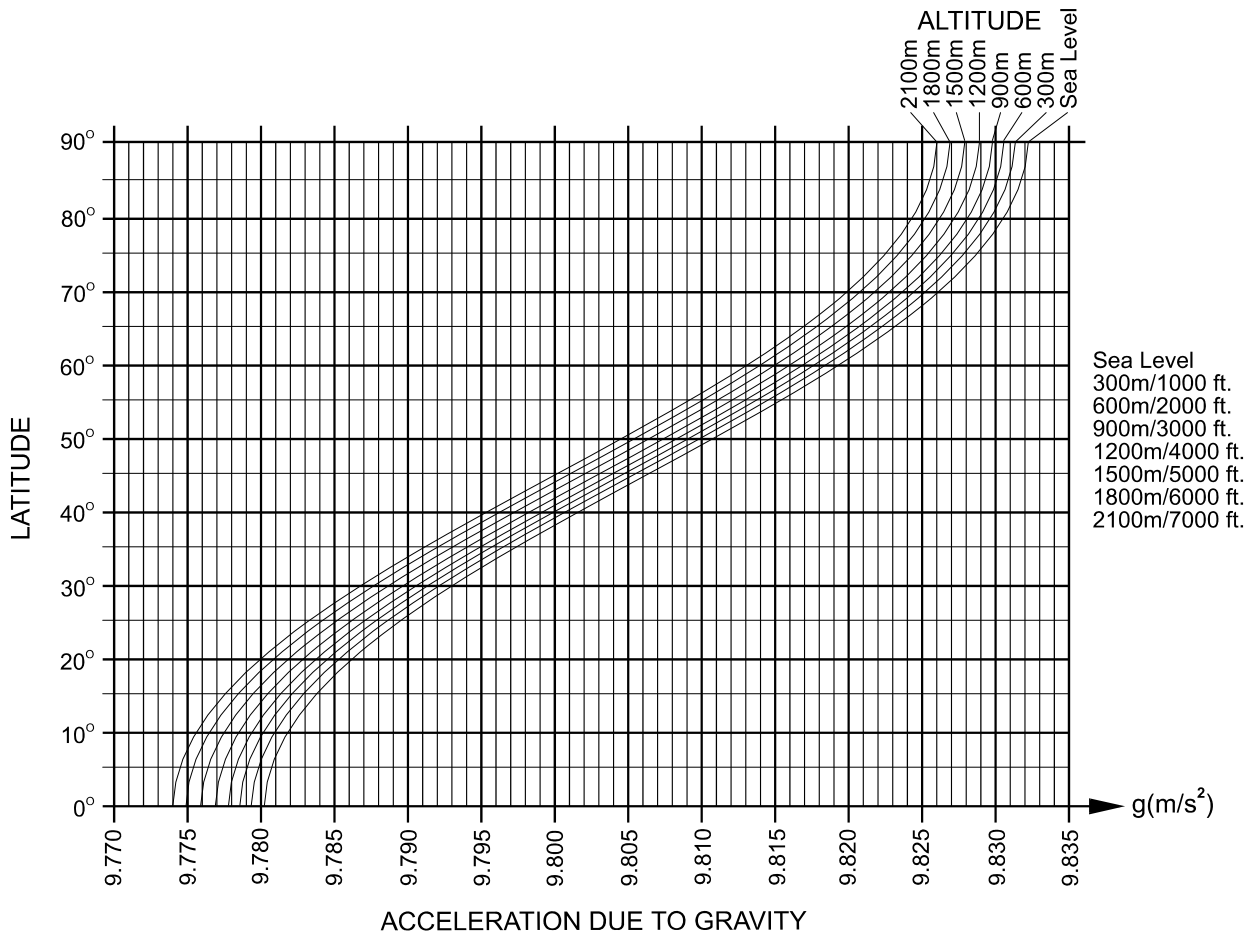

# World map

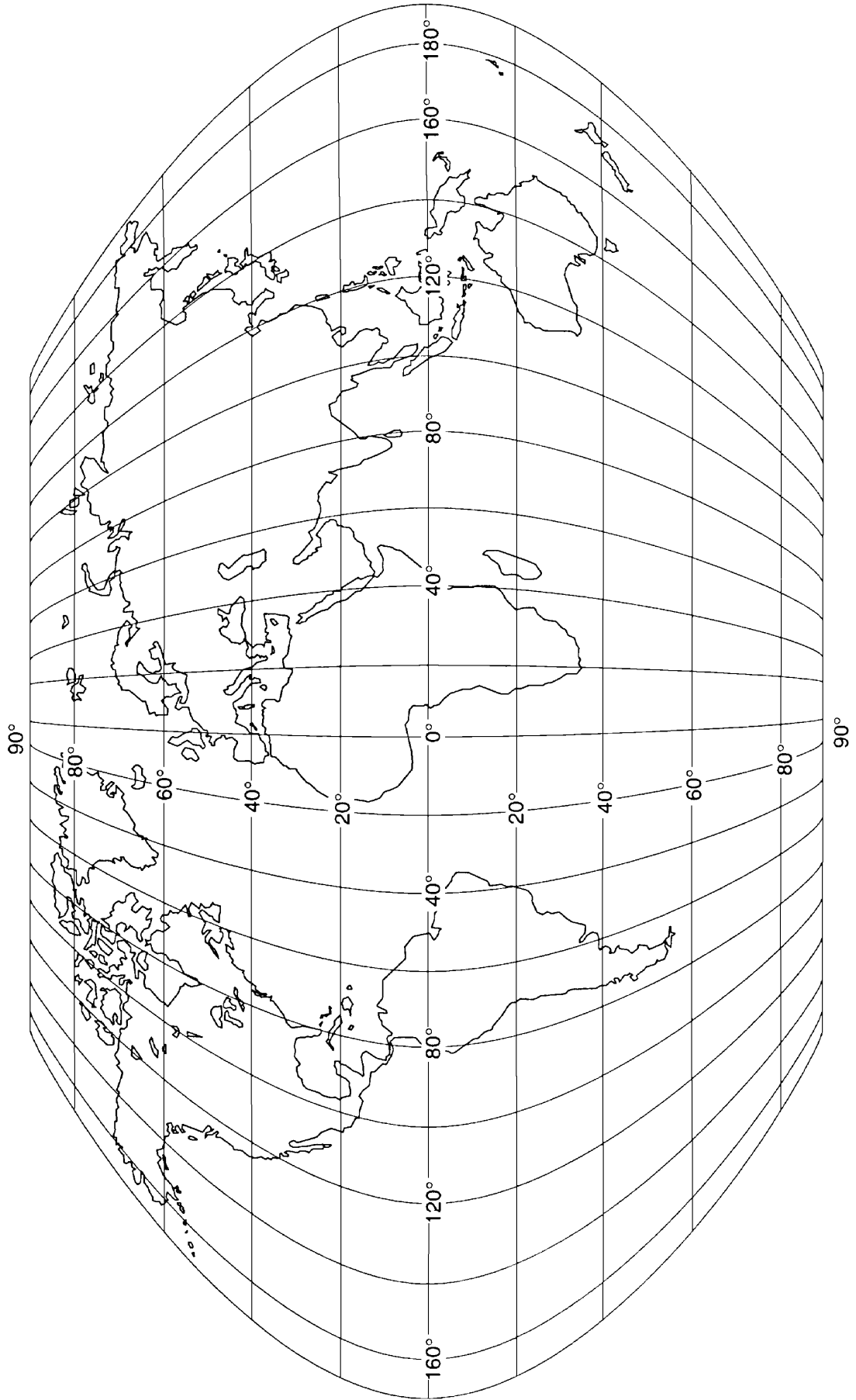





### **A&D Company, Limited**

3-23-14 Higashi-Ikebukuro, Toshima-ku, Tokyo 170-0013, JAPAN  
Telephone: [81] (3) 5391-6132 Fax: [81] (3) 5391-6148

### **A&D ENGINEERING, INC.**

1756 Automation Parkway, San Jose, California 95131, U.S.A.  
Telephone: [1] (408) 263-5333 Fax: [1] (408)263-0119

### **A&D INSTRUMENTS LIMITED**

Unit 24/26 Blacklands Way, Abingdon Business Park, Abingdon, Oxfordshire OX14 1DY United Kingdom  
Telephone: [44] (1235) 550420 Fax: [44] (1235) 550485

### **A&D AUSTRALASIA PTY LTD**

32 Dew Street, Thebarton, South Australia 5031, AUSTRALIA  
Telephone: [61] (8) 8301-8100 Fax: [61] (8) 8352-7409

### **A&D KOREA Limited**

한국에이.엔.디(주)  
서울특별시 영등포구 국제금융로6길33 (여의도동) 맨하탄빌딩 817 우편 번호 150-749  
( 817, Manhattan Bldg., 33. Gukjegeumyung-ro 6-gil, Yeongdeungpo-gu, Seoul, 150-749 Korea )  
전화: [82] (2) 780-4101 팩스: [82] (2) 782-4280

### **ООО A&D RUS**

ООО "ЭЙ энд ДИ РУС"  
121357, Российская Федерация, г.Москва, ул. Вереysкая, дом 17  
( Business-Center "Vereyskaya Plaza-2" 121357, Russian Federation, Moscow, Vereyskaya Street 17 )  
тел.: [7] (495) 937-33-44 факс: [7] (495) 937-55-66

### **A&D INSTRUMENTS INDIA PRIVATE LIMITED**

ऐ&डी इन्स्ट्रुमेन्ट्स इण्डिया प्रा० लिमिटेड  
509, उद्योग विहार , फेस -5, गुडगांव - 122016, हरियाणा , भारत  
( 509, Udyog Vihar, Phase-V, Gurgaon - 122 016, Haryana, India )  
फोन : 91-124-4715555 फैक्स : 91-124-4715599