

Table Of Contents

I .	Precautions Before Using The Scale -----	1
II.	Overall View -----	2
	(I) Package Contents-----	2
	(II)Overall View-----	2
III.	Explanation Of Display Symbols -----	3
IV.	Keypad Functions -----	5
V.	Connection Description -----	6
	(I) Remote port-----	6
	(II) Extra display/Control box port-----	6
	(III) RS-232 output port-----	8
VI.	Operations -----	9
	(I)Switch on & off-----	9
	(II) Zero the scale -----	10
	(III) Sampling before counting-----	10
	(IV) Counting by using reduction unit weight-----	13
	(V) Storing PLU (Price Look Up) to Memory -----	15
	(VI) Subtract container's weight-----	25
	(VII) Weight/Quantity accumulation-----	28
	(VIII) Preset counting check range-----	30
	(IX) Preset weight check range-----	33
	(X) Change platform-----	35
VII.	User Programming Functions -----	37
	(I) Auto. shut off time span-----	37
	(II) Backlight type-----	38
	(III) Change unit of measure from kg/g to Pound-----	39
	(IV) Unit weight recomputing-----	40
	(V) Transmit method setting-----	41
	(VI) Baud Rate setting-----	42
	(VII) Label format setting (available when a label printer is connected.)-----	43
	(VIII)Check alarm type-----	44

(IX) Cancel Tare setting-----	47
(X) Remote platform setting-----	48
(XI) Three section control signal-----	49
(XII) Transmit method of extra display-----	50
(XIII) Baud rate setting of extra display-----	51
(IXV)Zero Tracking Range-----	52
(XV)Zero display range-----	53
(XVI)Stable class range-----	54
(XVII)Stable class rate -----	55
VIII. Calibration (can only be done in kg/lb)- -----	56
IX. Power supply & battery operation -----	58
X. RS-232 Output -----	59
XI. Error Codes -----	66
XII. Technical Data -----	67

PRECAUTIONS

Warning

Precautions when installing the scale. To ensure that you get the most from your scale, please follow these instruction.

Do not disassemble the scale.

When any damage or defect occurs, contact your CAS authorized dealer immediately for proper repair.



Do not overload beyond the maximum weight limit.

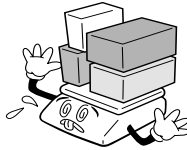

Scale must be grounded to minimize electricity static.

This will minimize defect or electric shock.



Do not pull the plug by its cord when unplugging.

Damaged cord could cause electric shock or fire.



To prevent from fire occurring, Do not place or use the scale near flammable or corrosive gas.

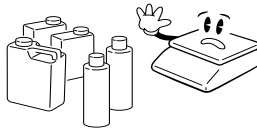

To reduce electric shock or incorrect reading, Do not spill water on the scale or place it in humid condition.

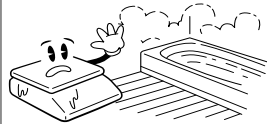

Avoid placing the scale near heater or in direct sunlight.



Insert plug firmly to wall outlet to prevent electric shock.

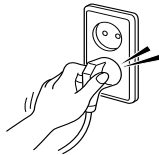

Use proper Adapter.

Incorrect adapter could damage the scale.

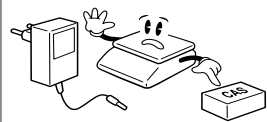

PRECAUTIONS

Attention

Make sure to plug your scal into the proper power outlet. For maximum performance, plug into a power outlet 30 minutes before the usage for warm up.

For consistent and accurate reading, maintain periodical check by your CAS authorized dealer.

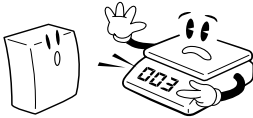

Avoid sudden shock to the scale.



Grab on the bottom of the scale when moving.



Keep the scale away from other electromagnetic generating devices.

This may interfere with accurate reading.



Place the scale on firm and temperature consistent environment.



By adjusting 4 corners of the scale, set the scale even using the built in scale leveling indicator.



Take the battery out when scale is not in use for long time. Leakage from the batteries is hazardous.

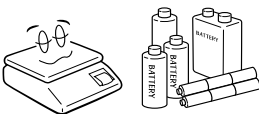

I . Precautions Before Using The Scale

Environment

The scale should always be used in an environment, which is free from excessive air currents, corrosives, vibration, and temperature or humidity extremes. These factors will affect displayed weight reading.

DO NOT install the scale:

- Next to open windows or doors causing drafts or rapid temperature changes.
- Near air conditioning or heating vents.
- Near vibrating, rotating or reciprocating equipment.
- Near magnetic fields or equipment that generates magnetic fields.
- On an unstable work surface
- In a dusty environment
- In direct sunlight.

Leveling the Scale

The scale is equipped with a level indicator on the back side, right bottom of the front panel and four adjustable leveling feet. Adjust the leveling feet until the bubble appears in the center circle of the indicator.

Turn on Scale

Do not turn on scale with anything on the platform.

Press the “ON/OFF” switch located on the right side of the bottom of the scale to turn on the scale.

The scale will start to count down from nine to zero. The scale is then ready for use. Give a warm-up for 15~30 minutes before use.

※ Attention ※

There is a dust protection cover as standard.

Before turning on the scale, the dust protection cover should be attached on the body with using an adhesive tape so that the cover does not touch the pan. If the cover touches the pan, a weight value can be wrong.

II. Installation

(I) Package Contents

Scale

Power Adapter

User Manual

Load cell connector: Use to connect scale with remote platform.

RS-232 connector: Use to connect the scale with extra display.

(II) Overall view

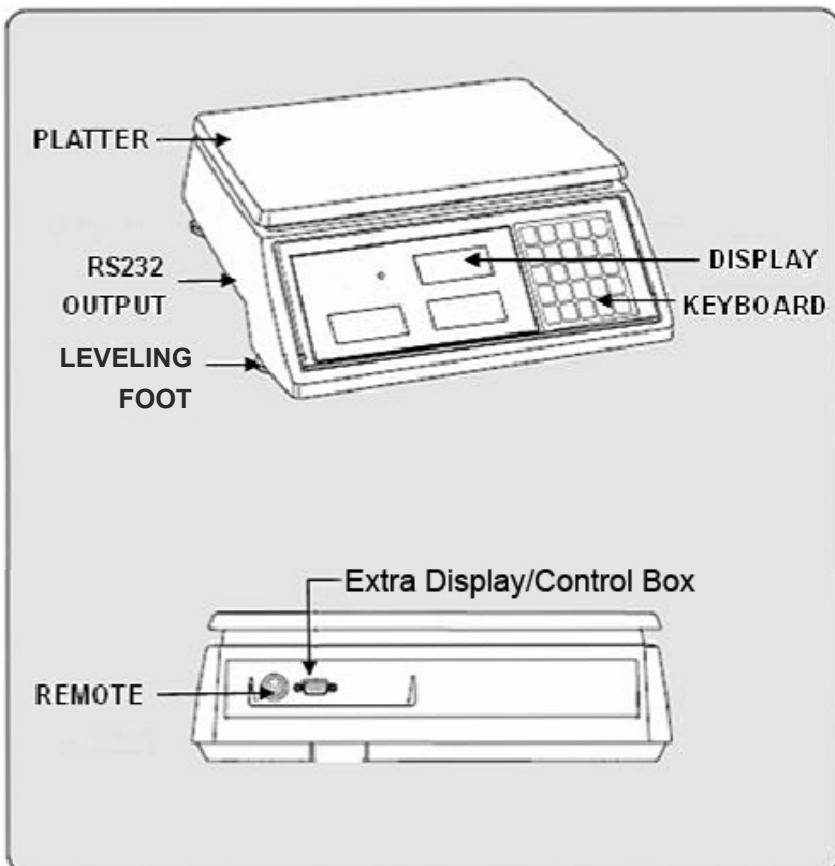

III. Explanation Of Display Symbols

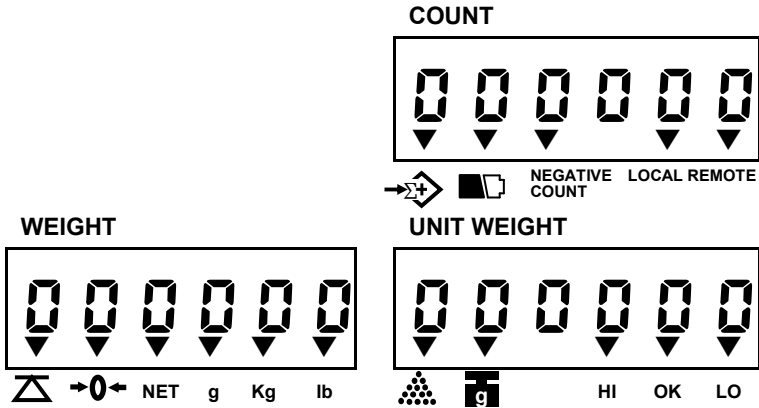

Display Windows

- **Weight Display –**

Total 6 digits for weight accumulated or being measured on the pan.







- **Unit Weight Display –**

Total 6 digits for unit weight or times of weight accumulated.

- **Count Display –**

Total 6 digits for number accumulated or being counted on the pan.

Indicated Symbols

Symbols	Specification
NET	Scale is in TARE mode.
	Scale is in ZERO mode.
	Scale is in ACCUMULATION mode.
	The display reading is in STABLE condition.
	Lack of Sample Weight If the total sample weight on the pan is less than <u>10 display divisions</u> , a triangular indicator will appear to remind the user to add more samples until the indicator disappears.
	Lack of Unit Weight If the unit weight is less than <u>1/10 display divisions</u> , a triangular indicator will appear to remind the user that the displayed unit weight is too small for getting accurate quantity calculations.
	Low Voltage
HI,LO,OK	Check alarm function indication.
g/kg/lb	Current weighing unit.
Negative Count	The scale is in negative counting mode.
Remote	Remote platform is used.

IV. Keypad Functions

Keys	Specification
0~9	Numeric keys
●	Decimal point key
C	Use this key to clear out the displayed numeric readings. Use this key to exit from setting mode.
ZERO	If there is a minor weight displayed without anything on the pan, Press the zero key to clear the display.
TARE	Use this key to preset the known tare value when nothing on the pan. Use this key to subtract container's weight.
SMPL	Use this key to input sample size.
U.WT	Use this key to input the known unit weight of item to be counted.
ALARM	Use this key to input the HIGH & LOW weight/quantity limit for check function.
ADD	Use this key to accumulate weight/quantity measured.
TOTAL	Use this key to recall total weight, count & accumulation times.
REMOTE	Use this key to change remote platform.
SET	Use this key to enter into User Programming Functions.
<u>ENTER</u> kg/lb	Use this key to confirm the parameter setting. Use this key to change weighing unit kg/lb.
<u>MOVE</u> +10	Use this key to move the parameter value in Set Mode. Shortcut key of "10" for sampling in counting mode.
MEMORY	Long press to enter into memory mode. Press this key twice to recall stored information.
GROSS	Use this key to display gross weight.

V. Connection Description

I. Remote port

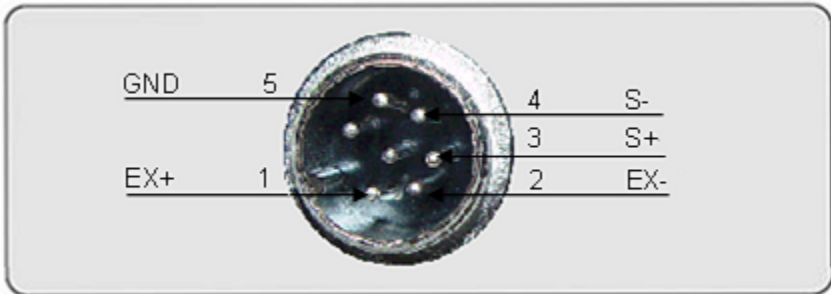

II. Extra display/Control box port

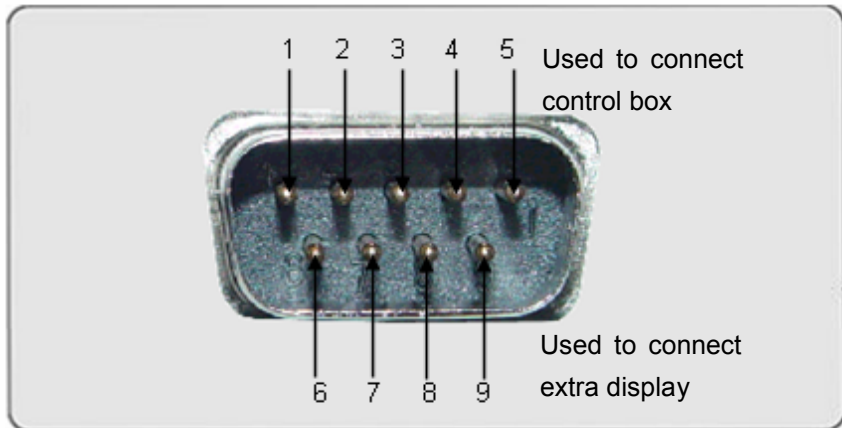

Control box :

Pin1	Pin2	Pin3	Pin4	Pin4
HI	OK	LO	VCC (5V)	GND

Extra display:

Pin6	Pin7	Pin8	Pin9
GND	RXD	TXD	

Description of the control box

Overall View

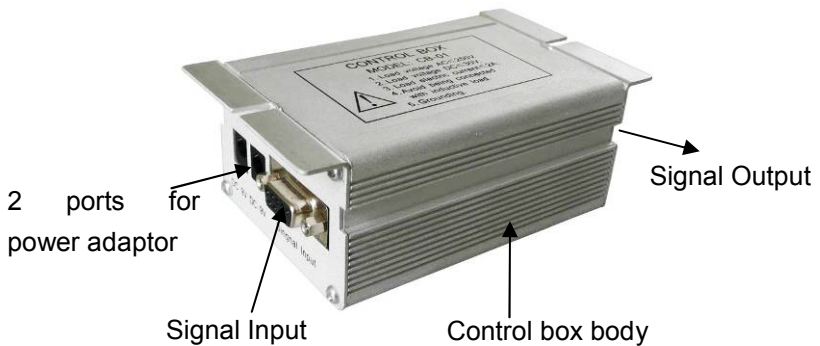

Signal Input port and ports for power adaptor



Use our standard cable to connect the signal input port with the scale.

And these two ports for power adaptor must be connected to make sure the control box is workable.

Signal Output port

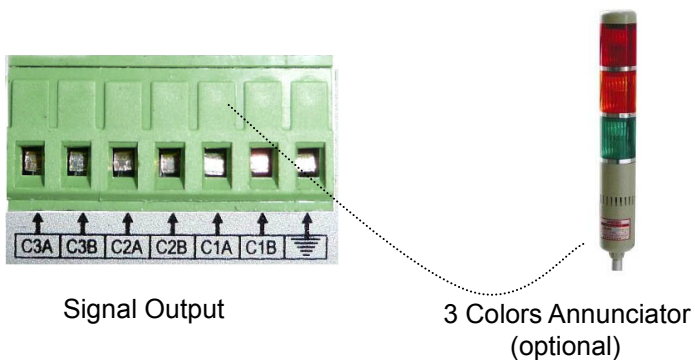

There are three section controllers, (C1A, C1B), (C2A, C2B), (C3A, C3B), each of them has two wire connectors. They work respectively.

The signal output port can be connected to a lamp, beeper, annunciator, etc.

Note: (C1A, C1B)= LO, (C2A, C2B)=OK, (C3A, C3B)=HI

III. RS-232 output port

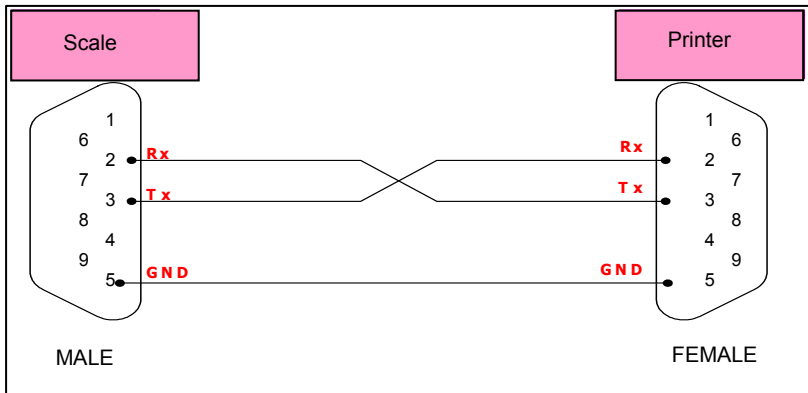

Connect EC-II and Printer using same cable. [male(EC-II) – female(DLP-50)]

VI. Operations

(I) Switch on & off

Push the ON/OFF switch to “1” position to turn on the scale & to “0” position to turn off the scale.

When turn on the scale, the display will show software version, all the segments and count down from “9” to “0”.

The scale will check the remote and local platform.

If the remote platform is not connected well, the display shows as below:

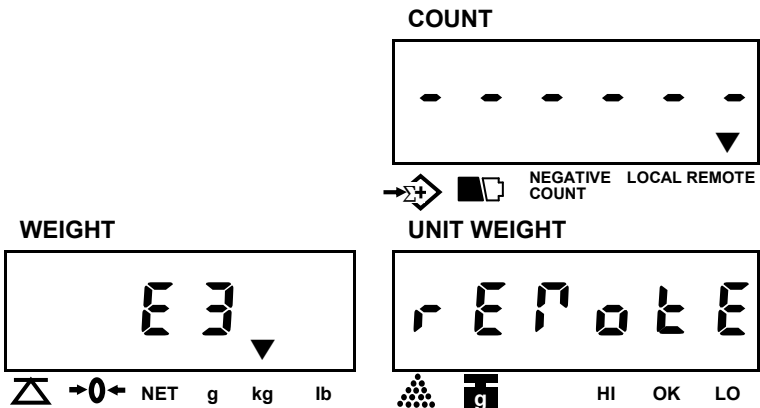

While when the local platform is not connected well, the display will show:

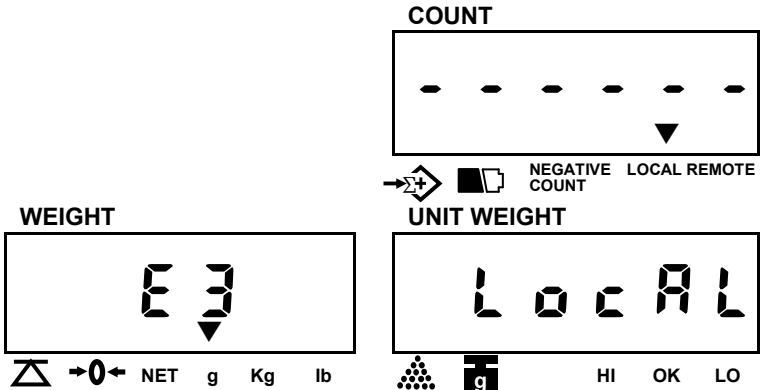

If you want to use remote platform, make sure that platform is connected properly before turning on the scale.

- ★ To use the remote platform, connect it to the scale and then turn OFF or ON the power.
- ★ Not to use the remote platform, the scale will automatically check the local platform in some seconds and go to normal mode if the local platform is well placed.

(II) Zero the scale

Press **ZERO** key to return the display to zero in case there is any zero drifting while unloaded.

(III) Sampling before counting

Unknown unit weight

1. Place a few pieces of item to be counted on the pan.

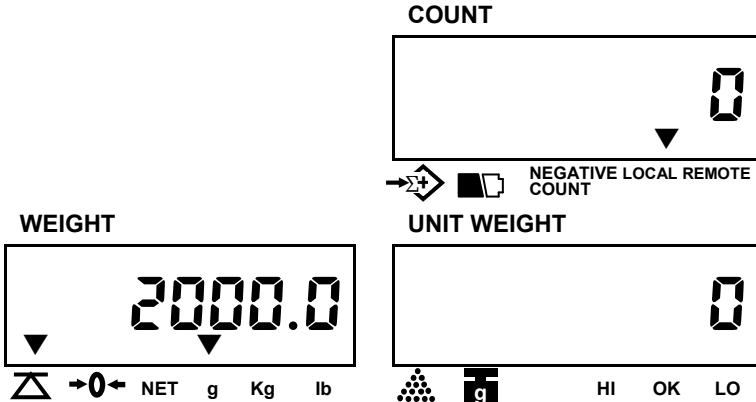

2. Input the quantity of item on the pan.

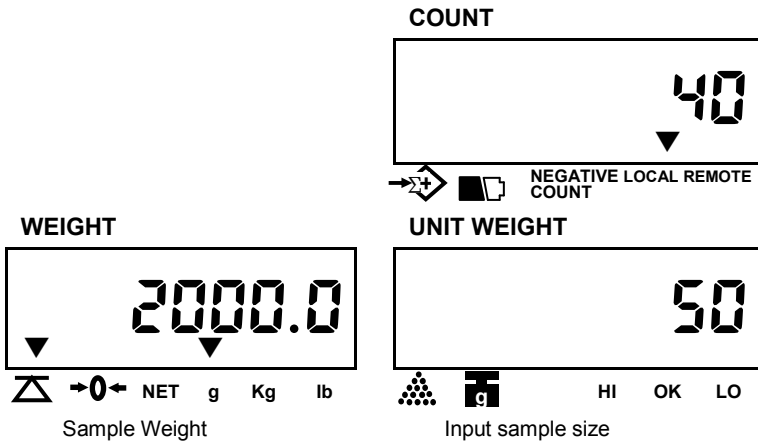

3. Press **SMPL** key

Note: The system default is “Unit Weight”. If the “**SMPL**” key is clicked when the value (ex.:40) in **COUNT** window is blinking, then the numerical value input will be as “Quantity”. If the “**SMPL**” key is not clicked when the value (ex.:40) in **COUNT** window is blinking, then the numerical value input will be as “Unit Weight”.

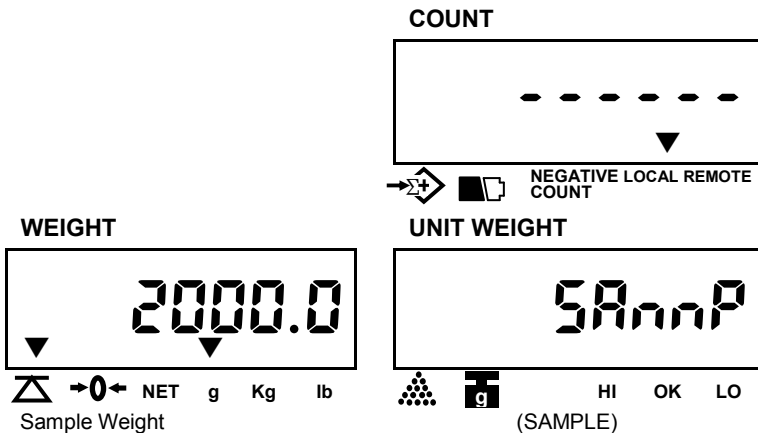

4. The sampling operation is completed while stable display appears as below :

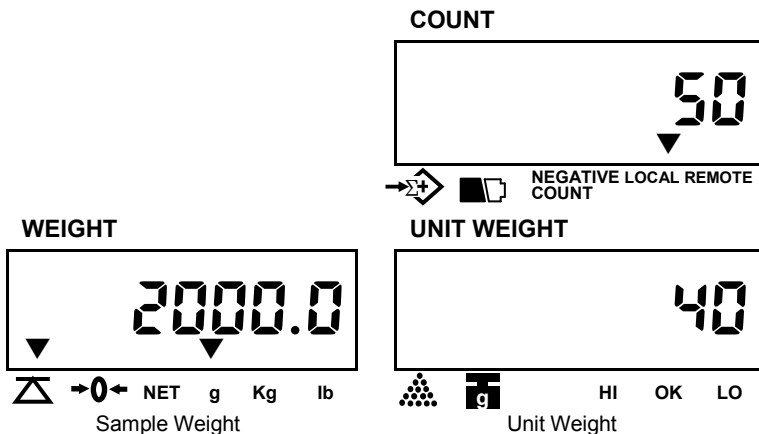

- ★ The larger sample size, the more accurate unit weight
- ★ Press **SMPL** key to recomputing unit weight during in counting process if the setting of “Unit Weight Recomputing” set to “on” (Please refer to Page 35 (IV) of section V, Unit weight recomputing).

Known unit weight

1. Input the known unit weight.

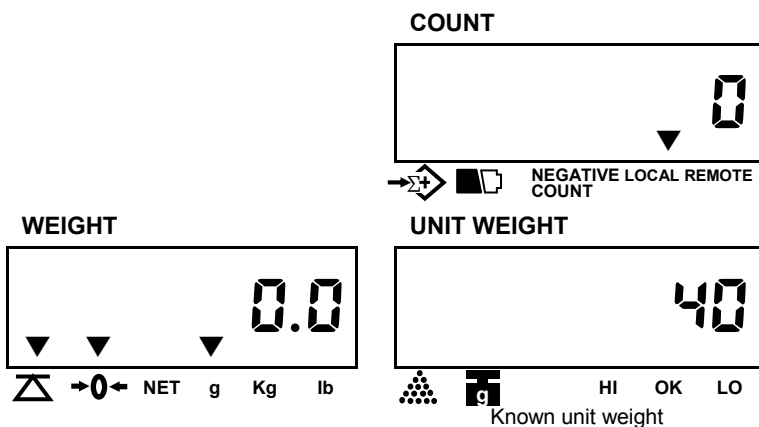

- Press **U.WT** key to complete sampling operation & enter into counting mode.

Note: The system default is “Unit Weight”. If the “**U.WT**” key is clicked when the value (ex.:0) in COUNT window is blinking, then the numeric value input will be as “Unit Weight”.

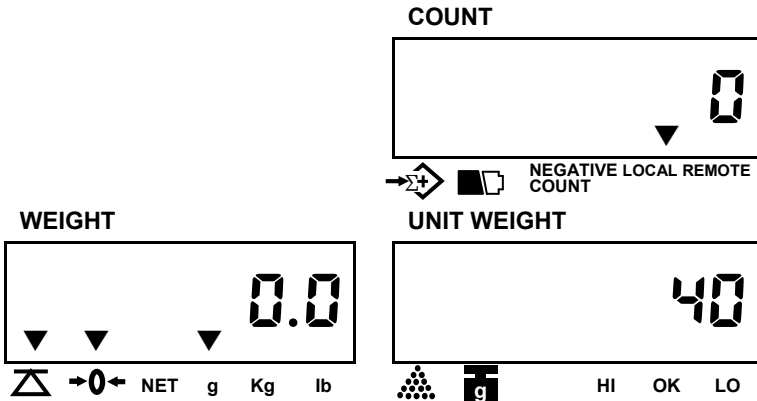

(IV) Counting by using reduction unit weight

- Place samples on the platter.

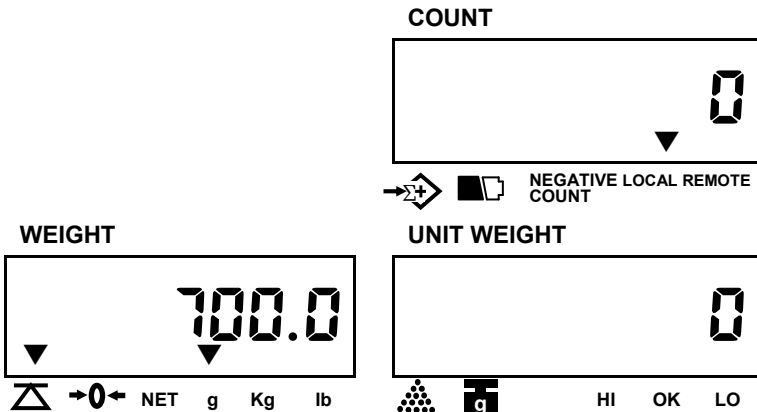

- Press **TARE** key.

WEIGHT

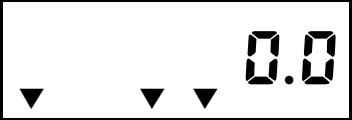



COUNT



UNIT WEIGHT



 → **0** ← **NET** **g** **Kg** **lb**
  **HI** **OK** **LO**

3. Remove some samples from the platter.

WEIGHT





COUNT



UNIT WEIGHT



 → **0** ← **NET** **g** **Kg** **lb**
  **HI** **OK** **LO**

4. Enter the number of samples which are removed and press the **SAMPLE** key. The unit weight appears and negative counting is performed.

WEIGHT

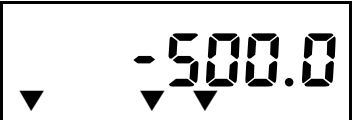



COUNT



UNIT WEIGHT



 → **0** ← **NET** **g** **Kg** **lb**
  **HI** **OK** **LO**

Release the reduction unit weight

Remove samples from the platter, press **TARE** and **CLEAR** keys.

(V) Storing PLU (Price Look Up) to Memory

How to store unit weight in memory cells

1. Give a long press of **MEMORY** to enter into Memory mode, and obtain unit weight by inputting the known value (ex.35g) or by sampling operation mentioned before. Press the **ENTER** key to confirm the value.

Note: Press the “**MOVE**” key to change the value when a wrong value entered.

2. Keyed in the unit weight value.

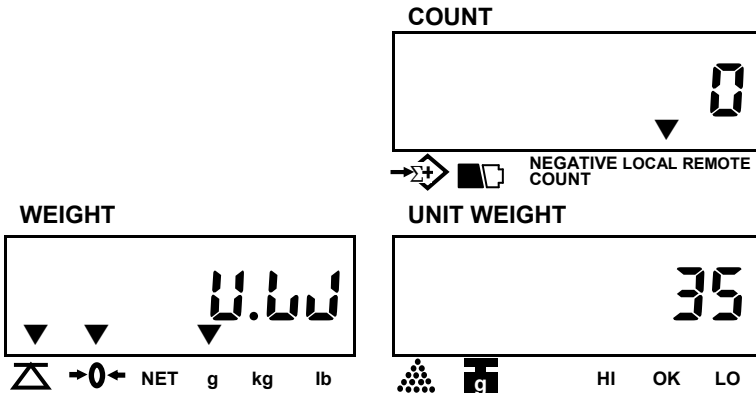

If sample operation is done before entering this mode, unit weight window will automatically show the unit weight.

3. Enter the tare value (ex. 10g) and press the **ENTER** key to confirm the value.

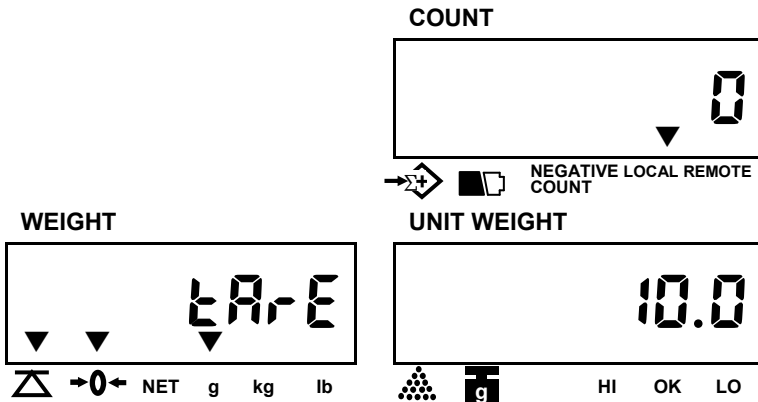

4. Enter the item number and press the **ENTER** key to confirm the value.

Note: You can enter up to 6 digits. (For example: Item number-800125)

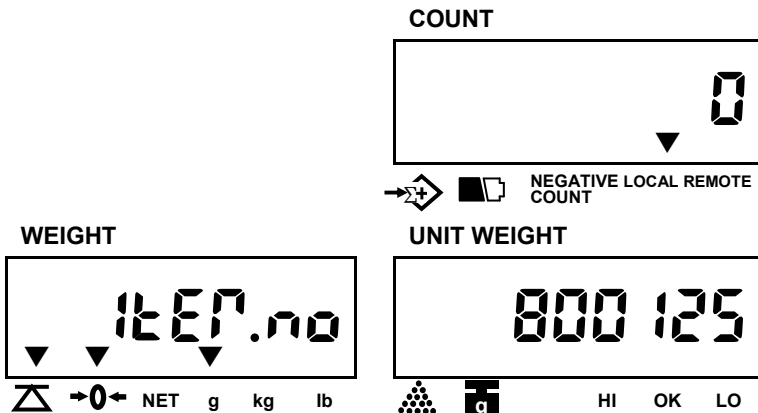

5. Enter item name by using ASCII code. Note that you can enter up to 16 digits. Refer to ASCII code on P18.

(For example: Register)

Enter ASCII code 52 for "R" and press the **ENTER** key

WEIGHT





COUNT



UNIT WEIGHT



 → **0** ← **NET** **g** **kg** **lb**
 **g** **HI** **OK** **LO**

Enter ASCII code 65 for "e" and press the **ENTER** key.

WEIGHT





COUNT



UNIT WEIGHT



 → **0** ← **NET** **g** **kg** **lb**
 **g** **HI** **OK** **LO**

Enter ASCII code 67 for "g" and press the **ENTER** key, etc.

WEIGHT





COUNT



UNIT WEIGHT



 → **0** ← **NET** **g** **kg** **lb**
 **g** **HI** **OK** **LO**

You can enter the rest data in the same way as above and press **ENTER** key.

If you have finished entering the item name before 16 digits, press the **CLEAR** key to enter into the next setting.

ASCII code:

H	2	3	4	5	6	7
0		0	@	P	'	p
1	!	1	A	Q	a	q
2	"	2	B	R	b	r
3	#	3	C	S	c	s
4	\$	4	D	T	d	t
5	%	5	E	U	e	u
6	&	6	F	V	f	v
7	'	7	G	W	g	w
8	(8	H	X	h	x
9)	9	I	Y	i	y
A	*	:	J	Z	j	z
B	+	;	K	[k	{
C	,	<	L	\	l	
D	-	=	M]	m	}
E	.	>	N	^	n	~
F	/	?	O	-	o	△

Keys for item name programming

7	8	9		MOVE/+10
4	5	6		ENTER
1	2	3	MEMORY	
0		CLEAR		F
A	B	C	D	E

6. Press **MOVE** key to select weight or count for compare.

WEIGHT

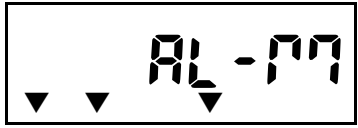

COUNT



→ **NEGATIVE LOCAL REMOTE COUNT**

UNIT WEIGHT



→ **0** ← **NET** **g** **kg** **lb** **HI** **OK** **LO**

“C”=Count “C”=Weight

7. Set the alarm type.(in, out).(Default setting:In)

WEIGHT

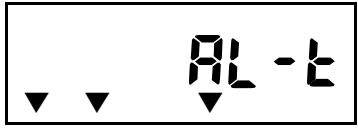

COUNT



→ **NEGATIVE LOCAL REMOTE COUNT**

UNIT WEIGHT



→ **0** ← **NET** **g** **kg** **lb** **HI** **OK** **LO**

8. Set the high limit value

WEIGHT

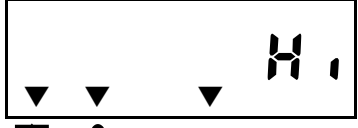

COUNT



→ **NEGATIVE LOCAL REMOTE COUNT**

UNIT WEIGHT



→ **0** ← **NET** **g** **kg** **lb** **HI** **OK** **LO**

9. Set the low limit value.

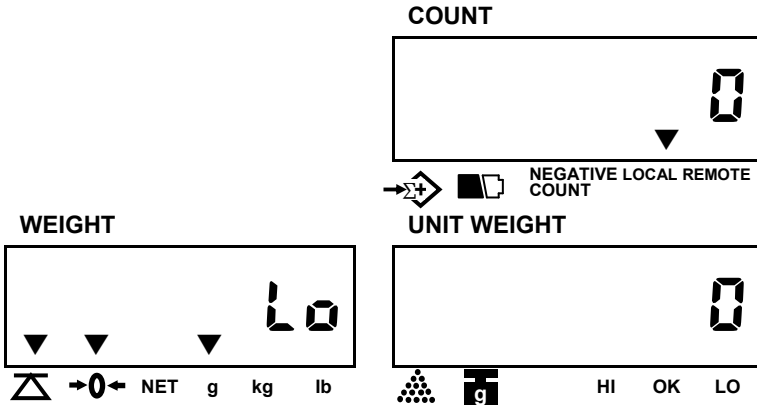

10. Enter a address cell (1~200, total 200 cells available) by pressing any of the numeric keys (0~9), then press the **ENTER** key to store the above information into the address cell.

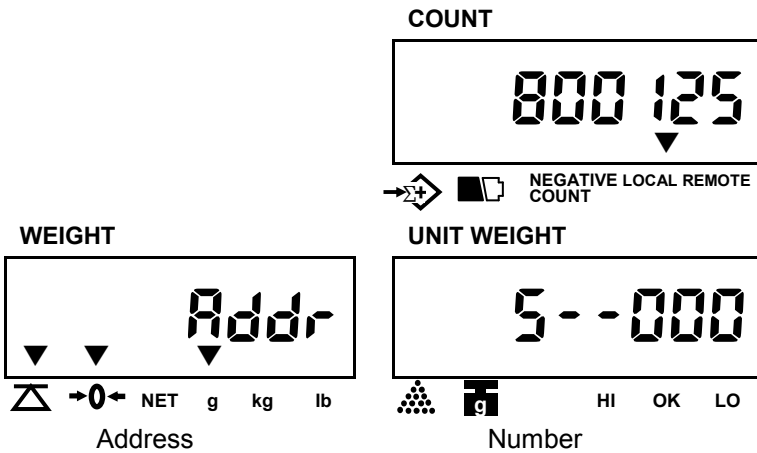

- Note:** 1) An error message “E4” appears if the address code is out of “1~200”.
- 2) When the address number has been used, the display will remind you if you want to update the memory.

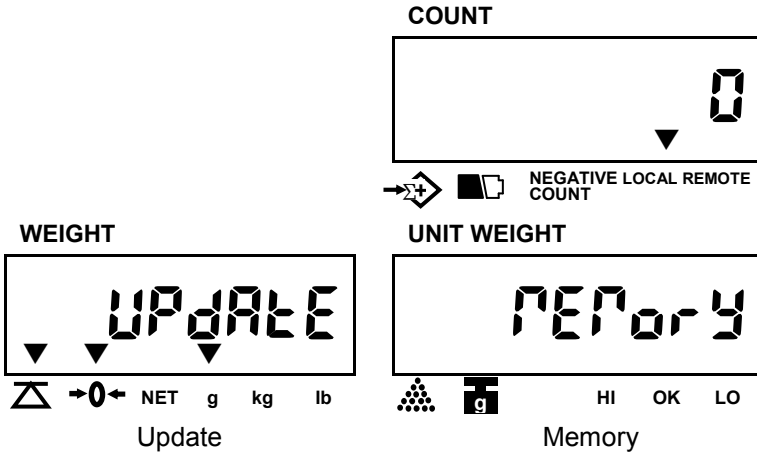

Press the **ENTER** key to confirm, then the memory will be updated.

Press the **CLEAR** key to enter the new address.

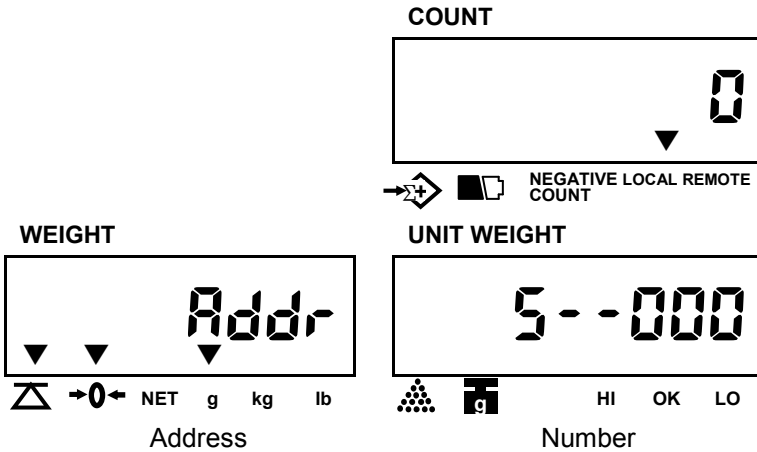

Note: 1) Press **CLEAR** key to clear out the current keyed in value.

2) When the current value displayed is the default one, press **CLEAR** key to exit from memory mode.

How to recall the data stored

Press the numeric key with stored data & keep pressing **MEMORY** key twice. You will see the unit weight and tare on the display.

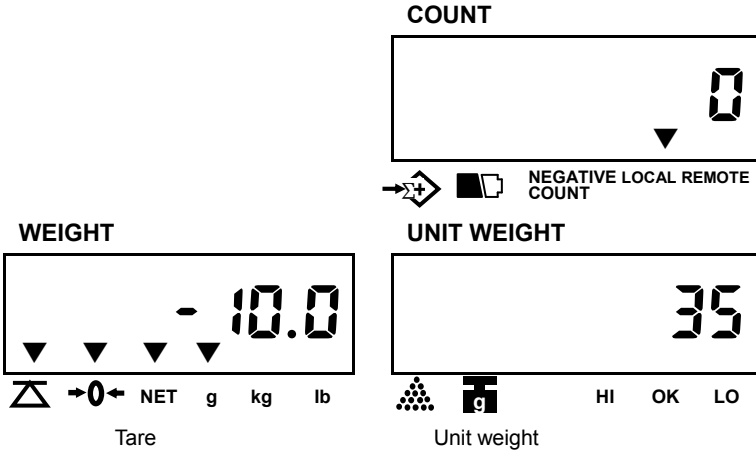

Place the sample on the pan, weight window shows the net weight.

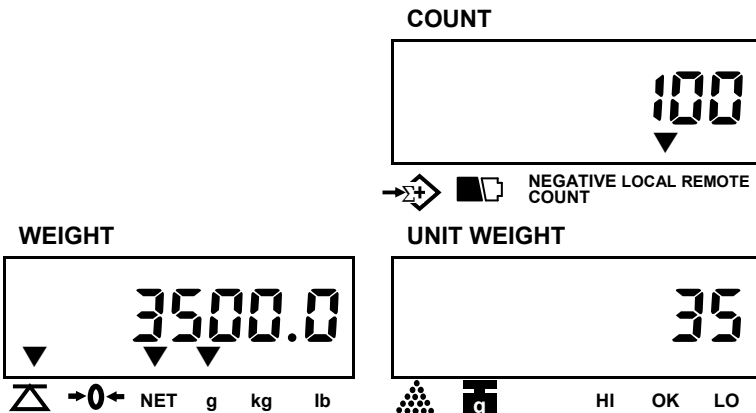

- Note:**
- 1) Press the **CLEAR** key to exit recalling memory mode.
 - 2) Press the **U.WT** key during recall memory mode (Ex. address number 100) to check the item number.

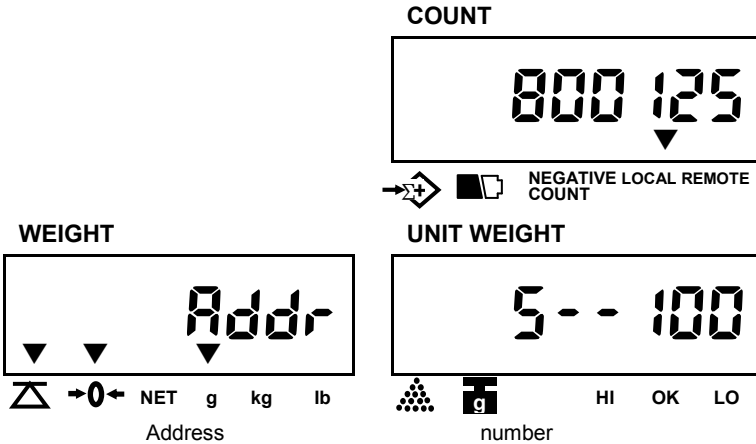

Remark: When the Alarm Setting is set during in the Recall Memory Mode, the Item Number and PLU Number can not be recalled.

When the recalled Tare value is over the max.capacity, the display will show:

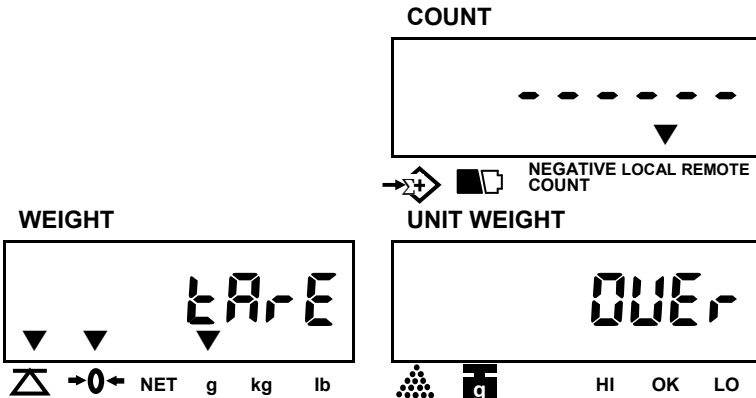

When the high limit for weight is larger than the max.capacity, the display will show:

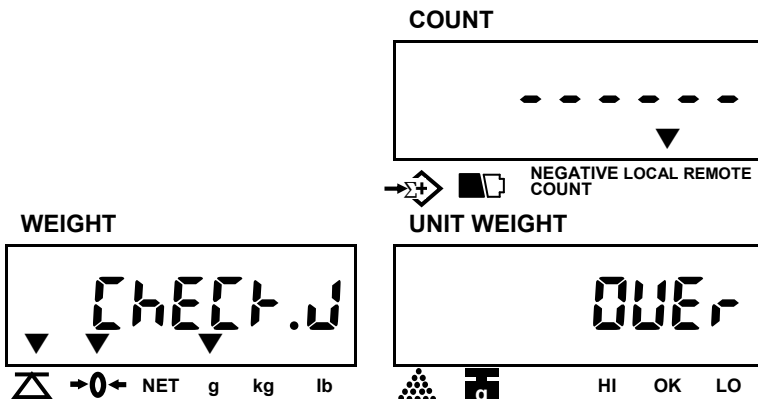

Three seconds later ,the display will show:

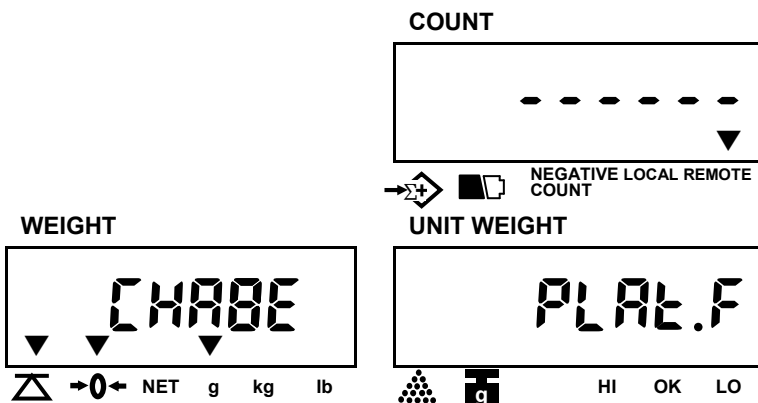

- ★ When the display shows as above, press **ENTER** key to confirm, the scale will automatically change to remote platform. But if the remote platform is not connected to the scale, local platform is still used.
- ★ If don't press **ENTER** key to change platform within 3 secondes, current platform is still used.

(VI) Subtract container's weight

weight unknown

1. Place a container on the pan.

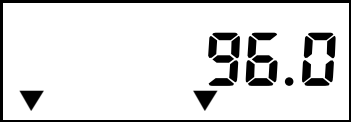

WEIGHT



 → 0 ← NET g kg lb
 Container's weight



COUNT



  NEGATIVE LOCAL REMOTE COUNT

UNIT WEIGHT



  HI OK LO

2. Press **TARE** key

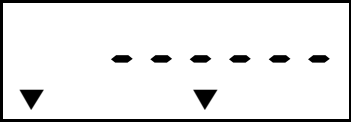

WEIGHT



 → 0 ← NET g kg lb

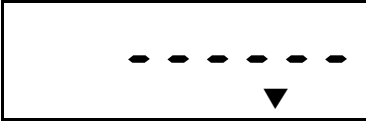

COUNT

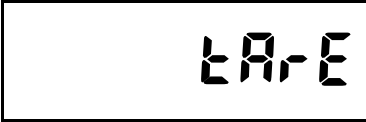

  NEGATIVE LOCAL REMOTE COUNT

UNIT WEIGHT



  HI OK LO

3. The scale will enter into counting mode while stable display appears as below.

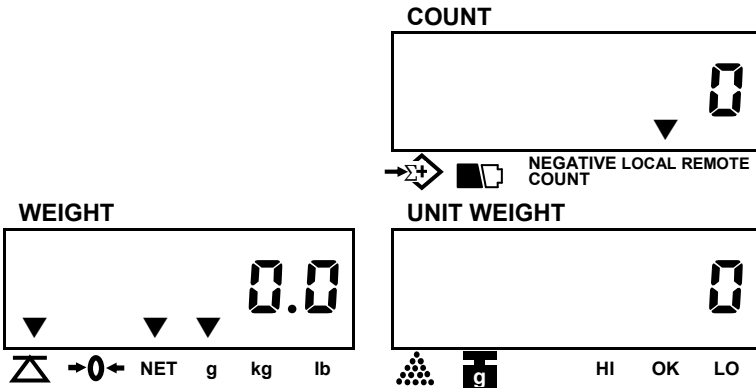

Container's weight known

1. Nothing on the pan

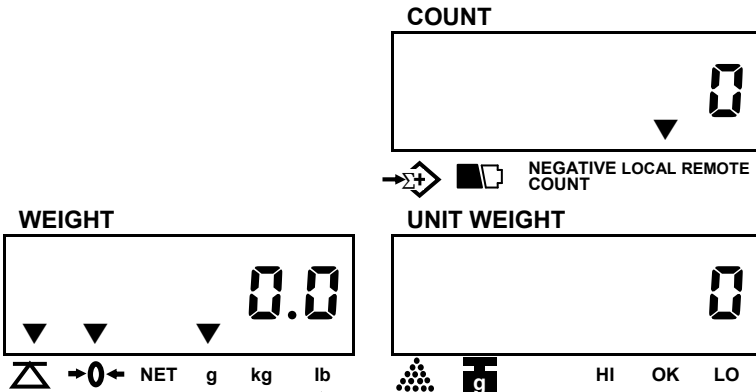

Give a long press of TARE key

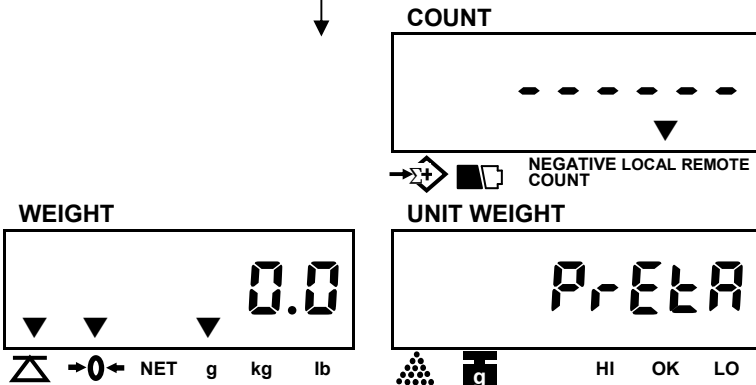

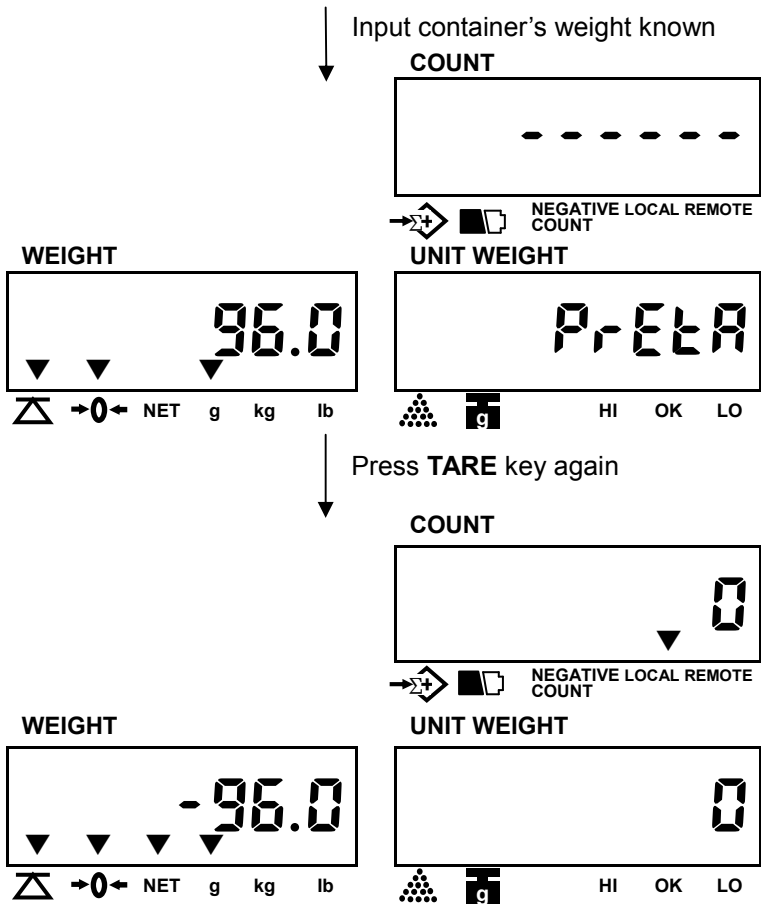

➡ **Eliminate TARE**

Remove all on the pan & the weight display will show a negative (-) container's weight. Pressing **TARE** key at this moment will bring the weight display to zero and NET triangular indicator (▼) will disappear.

Check the gross weight

To check the weight including tare, press the **GROSS** key.

COUNT

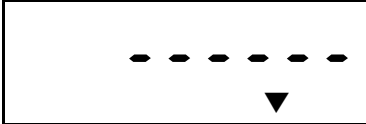





WEIGHT



UNIT WEIGHT



  NET g kg lb   HI OK LO

NEGATIVE LOCAL REMOTE COUNT

To release this function, press the **GROSS** key again.

(VII) Weight/Quantity accumulation

1. Place item to be weighed/counted on the pan.

COUNT







WEIGHT



UNIT WEIGHT



  NET g kg lb   HI OK LO

NEGATIVE LOCAL REMOTE COUNT

Weight on the pan

2. Press **ADD** key.

COUNT

WEIGHT

UNIT WEIGHT

→0← NET g kg lb

NEGATIVE LOCAL REMOTE COUNT

4. Display readings to be stable as below.

COUNT

WEIGHT

UNIT WEIGHT

→0← NET g kg lb

Total accumulated weight

NEGATIVE LOCAL REMOTE COUNT

Total accumulation times

★ Accumulation effective only when stays at zero.

4. Press **TOTAL** key or wait approx. 2 seconds, the scale will return to counting mode.

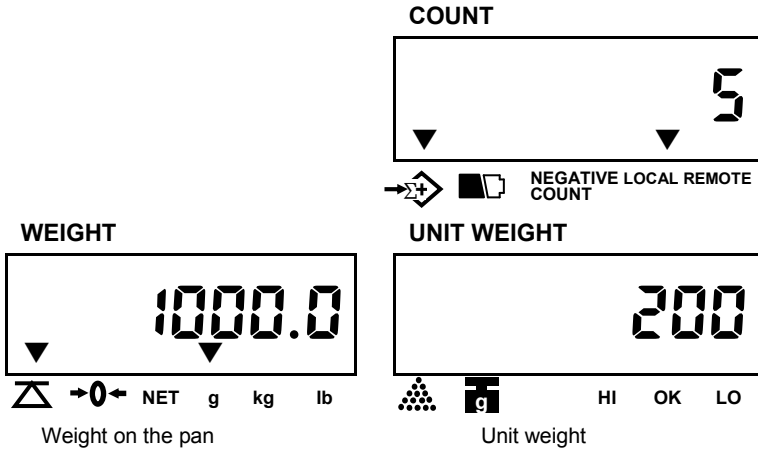

5. Press **TOTAL** key to enter into accumulation status mode. At this moment, total accumulated weight is shown in WEIGHT window, total accumulation times is shown in UNIT WEIGHT window and COUNT window displays accumulated count.

Press **TOTAL** key again to revert to counting mode.

➡ **Clear accumulation**

Press **TOTAL** key to enter into accumulation status mode and press **CLEAR** key to clear all accumulated data.

(VIII) Preset counting check range

Users can set a Hi – Lo range for counting check, when the number of objects on the pan is within the preset counting check range, the alarm will sound beeps repeatedly.

Procedures

1. Press **ALARM** key while the scale is either loaded or unloaded.

COUNT



Low limit value to be input

WEIGHT

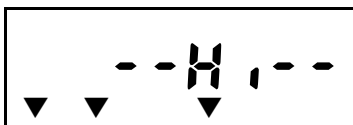

High limit

UNIT WEIGHT



High limit value to be input

2.Key in the desired high limit value.

(use **CLEAR** key to erase the value keyed in)

COUNT



Low limit value to be input

WEIGHT

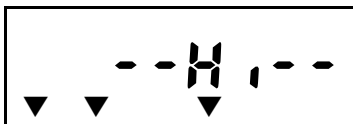

High limit

UNIT WEIGHT



High limit value keyed in

3.Press **ALARM** key again and key in the desired low limit value as indicated below. (Low limit value effective only after high limit is preset)

COUNT





→+ NEGATIVE LOCAL REMOTE COUNT

Low limit value to be input

WEIGHT

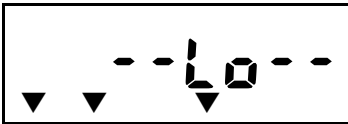

→0← NET g kg lb

Low limit

UNIT WEIGHT



HI OK LO

High limit value keyed in

4. Press **SMPL** key to complete counting check range preset procedure and return to normal counting mode.

Note: If it is in counting mode, press **ALARM** key again to set count-check range.

COUNT



→+ NEGATIVE LOCAL REMOTE COUNT

WEIGHT

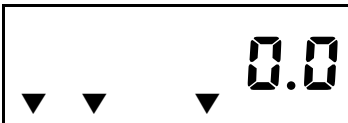

→0← NET g kg lb

UNIT WEIGHT



HI OK LO

Note: 1) An error message “E5” appears When the **LO** value is set higher than **HI** value.

2) When both **HI** and **LO** values are needed, they must be kept same decimal digits. (Ex. HI=10g, LO=9.8g, then the values must be set as “HI=10.0g, LO=9.8g”.)

(IX) Preset weight check range

Users can set a Hi – Lo range for weight check when the weight of objects on the pan is within the preset weight check range, the alarm will sound beeps repeatedly.

Procedures

1. Press **ALARM** key while the scale is either loaded or unloaded.

WEIGHT

COUNT

UNIT WEIGHT

→0← NET g kg lb
High limit

NEGATIVE LOCAL REMOTE COUNT
Low limit value to be input

g
High limit value to be input

2. Key in the desired high limit value.

(Use **CLEAR** key to erase the value keyed in)

WEIGHT

COUNT

UNIT WEIGHT

→0← NET g kg lb
High limit

NEGATIVE LOCAL REMOTE COUNT
Low limit value to be input

g
High limit value to be input

3. Press **ALARM** key again and key in the desired low limit

value as indicated below.

(★ low limit value effective only after high limit is preset)

COUNT



Low limit value to be input

WEIGHT

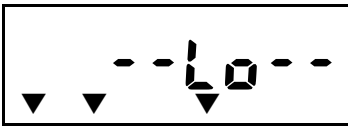

Low limit

UNIT WEIGHT



High limit value keyed in

4. Press **U.WT** key to complete weight check range preset procedures and return to normal counting mode.

Note: If it is in weighing mode, press **ALARM** key to set weight-check range.

COUNT



WEIGHT

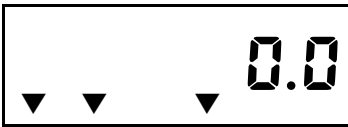

UNIT WEIGHT



Note: 1) An error message "E5" appears When the **LO** value is set higher than **HI** value.

2) When both **HI** and **LO** values are needed, they must be kept same decimal digits. (Ex. HI=10g, LO=9.8g,

then the values must be set as “HI=10.0g, LO=9.8g”.)

➡ Clear high / low value preset

Follow the above preset procedures and key in “ 0 ” or press **CLEAR** key directly for high and low limit value.

Backlight color indication in check-weight/count.

The backlight color is dependent on the backlight type setting. (Please refer to Page33(II) of section IV, Backlight type setting)

★ When the backlight type is set to be “Auto”, there are three colors for check-weight/count.

Red color: The weight/ count on the pan is higher than the high limit.

Green color: The weight/count on the pan is between the hi-lo check range.

Yellow color: The weight/count on the pan is lower than the low limit.

★ When the backlight type is set to be “Manual”

Press decimal point key “.” to set the backlight to be on, the color is always in green.

(X) Change Platform

1. When the local platform is used, press **REMOTE** key to change to remote platform. The display shows as below:
(Make sure the Remote Platform setting is set to be “on”. Please refer to P43.)

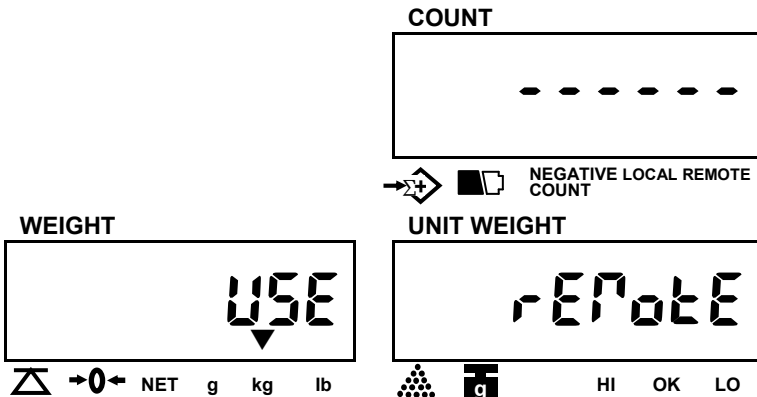

3 seconds later, the scale returns to normal mode and **REMOTE** indicator will be on. Remote platform is used.

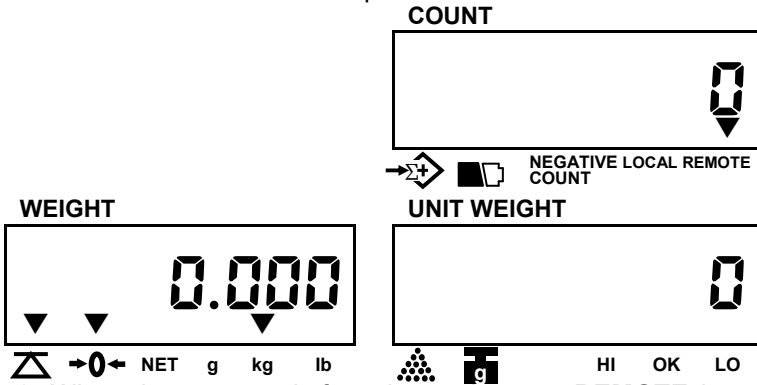

2. When the remote platform is used, press **REMOTE** key to change to local platform. The display shows as below:

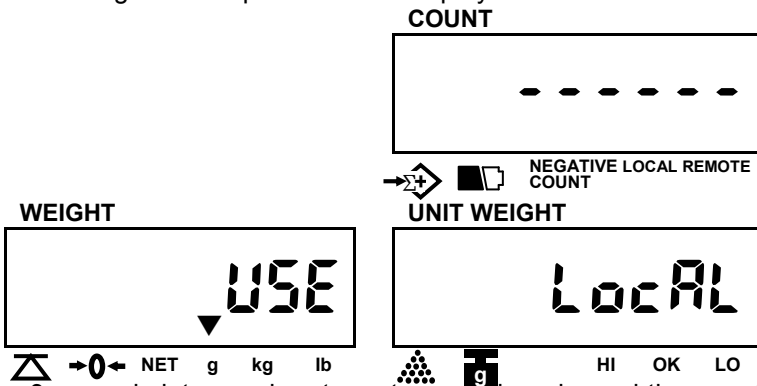

3 seconds later, scale returns to normal mode, and the remote indicator will be off.

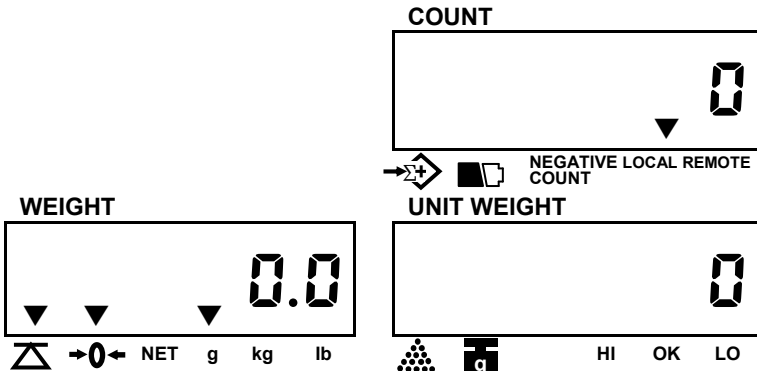

VII. User Programming Functions

In counting mode, press **SET** key to enter into USER PROGRAMMING FUNCTION MODE. After pressing “**SET**” key, the display shows “PASS WORD” to prompt to key in a pass word “101010”, then press “Enter” key to confirm the pass word. If the pass word is wrong, then the scale can not to enter into User Programming Function Mode.

- ★ The display shows “error” to prompt the mistake when the pass word is wrong.
- ★ If wrong pass word is entered for two times, then the scale will return to counting mode automatically.

(I) Auto. shut off time span

1. When enter into “User Programming Functions” mode, the displays will indicate as below eventually.

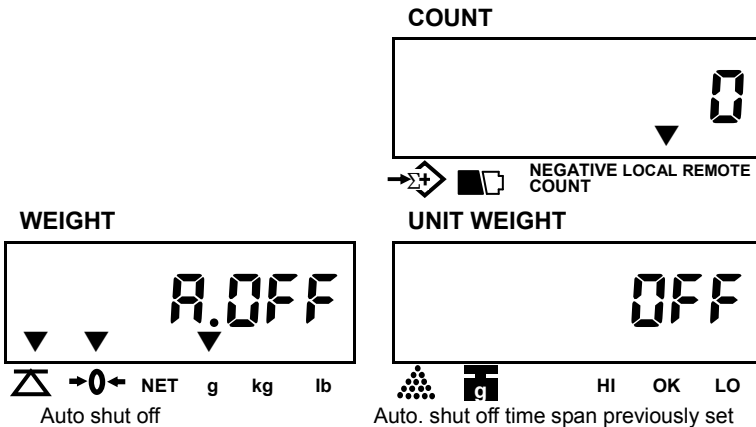

2. Press **MOVE** key to revolve the system-preset time span (2 min., 5 min., 8 min., and OFF),
(**Default setting:** OFF)
3. Press **CLEAR** key to determine and return to normal counting mode or press **ENTER** key for determination and move to next.

- ★ **Turn off the scale to return to normal counting mode.**

(II) Backlight type

1. Keep pressing **ENTER** key in USER PROGRAMMING FUNCTION MODE and release until the following displays appear.

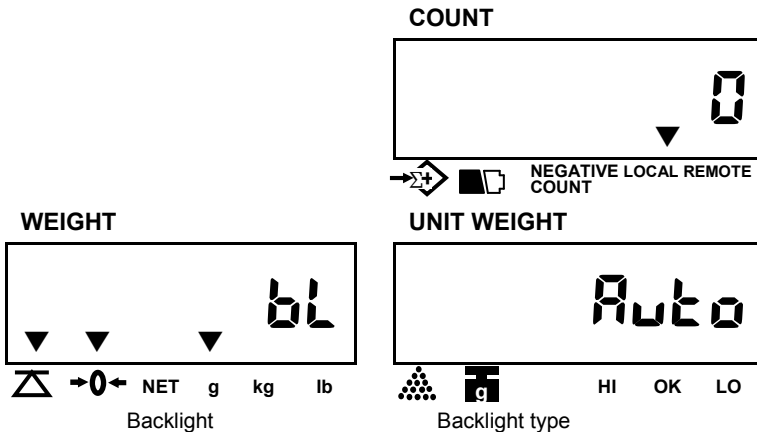

2. Press **MOVE** key to revolve the system-preset backlight type (**Auto**— auto. backlight, **MANUAL**— manual backlight).
(**Default setting:** **Auto**)
3. Press **CLEAR** key to determine and return to normal counting mode or press **ENTER** key for determination and move to next.

● Auto. Backlight

Backlight will be going on automatically whenever the scale is loaded by objects weigh greater than **9 display resolution** or any of keys is pressed. And it will be going off also automatically approx. 5 seconds after the scale returns to zero.

● Manual backlight

Press  (decimal point) key to switch on and off backlight.

- ★ Scale will keep the backlight type selected in memory for next use.
- ★ **Turn off the scale to return to normal counting mode.**

(III) Change unit of measure from kg to Pound

1. Keep pressing **ENTER** key in USER PROGRAMMING FUNCTION MODE and release until the following displays appear.

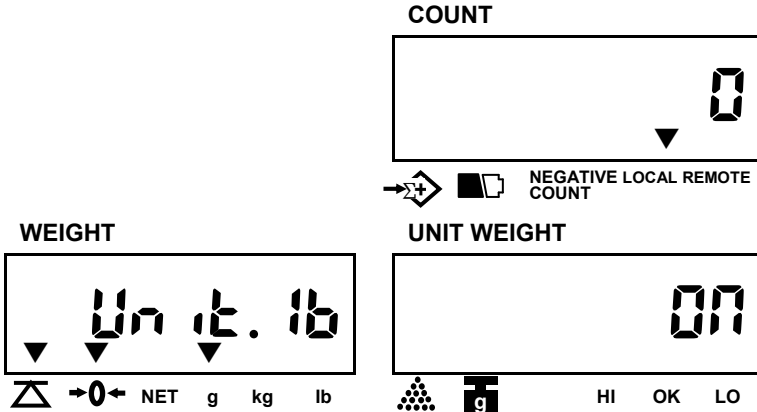

2. Press **MOVE** key to revolve the system-preset units of measure (ON, OFF).
(Default setting: ON)
 3. Press **CLEAR** key to determine and return to normal counting mode or press **ENTER** key for determination and move to next.
- ★ Turn off the scale to return to normal counting mode.

(IV) Unit weight recomputing

1. Keep pressing **ENTER** key in USER PROGRAMMING FUNCTION MODE and release until the following displays appear.

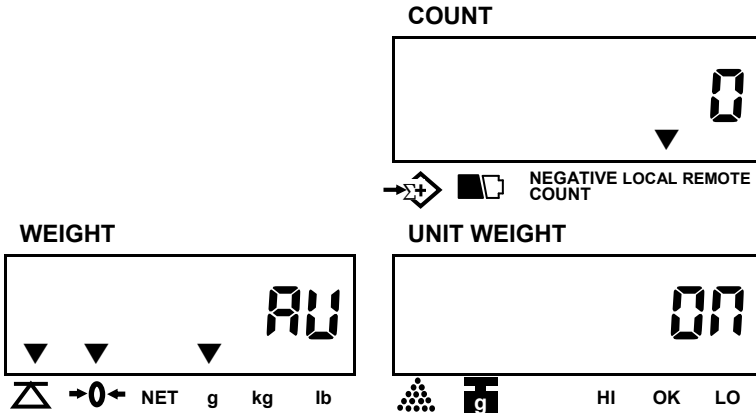

2. Press **MOVE** key to revolve the system-preset recomputing mode. (**Default setting: on**)
 off– disable recomputing function
 on – enable recomputing function
3. Press **CLEAR** key to determine and return to normal counting mode or press **ENTER** key for determination and move to next.

★ The unit weight will be averaged again if you add the remaining quantity, gradually, by several lots. This will help eliminate errors caused by the **possible weight variation among each object** and lead to more accurate results.

When adding objects to the pan (**The weight value should not be less than 10 display divisions.**), be sure that the quantity is LESS THAN those already on the pan. The alarm will sound a beep when the unit weight is averaged again.

- ★ Recomputing function effective only after sampling operation is done.
- ★ **Turn off the scale to return to normal counting mode.**

(V) Transmit method setting

1. Keep pressing **ENTER** key in USER PROGRAMMING FUNCTION MODE and release until the following displays appear.

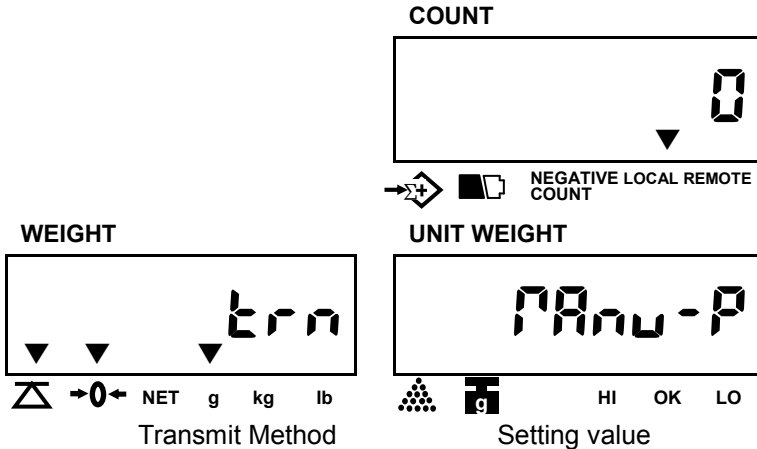

2. Press **MOVE** key to revolve the system-preset transmit method.

(Default setting: P R n u - P)

“P R n u - P” = transmit by pressing a key (ex. DEP-50, PC).
Negative value can not be transmitted.

“S E r i E S” = series transmit (ex. DEP-50, PC)

“P R n u - L” = transmit by pressing a key (for a label printer, such as: Model “DLP-50”). Negative value can not be transmitted.

“R u t o - L” = auto-transmit (for a label printer, such as: Model “DLP-50”)

3. Press **ENTER** key to determine and return to next setting.
- ★ **Turn off the scale to return to normal counting mode.**

(VI) Baud Rate setting

1. Keep pressing **ENTER** key in USER PROGRAMMING FUNCTION MODE and release until the following displays appear.

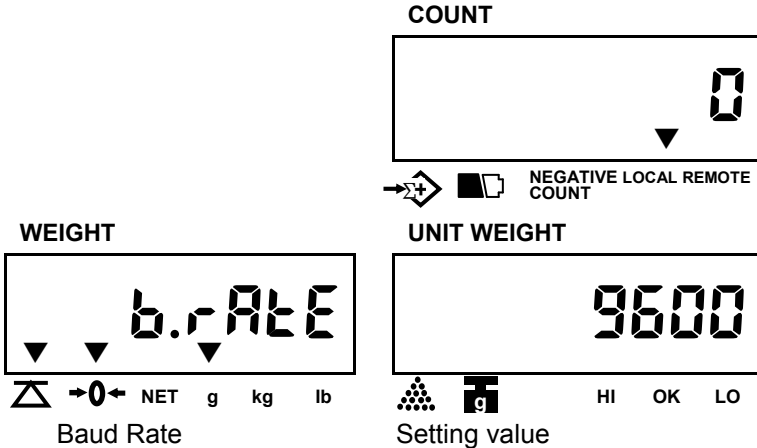

2. Press **MOVE** key to revolve the system-preset baud rate.(2400 , 4800, 9600)
(Default setting: 9600)
 3. Press **ENTER** key to determine and return to next setting.
- ★ Turn off the scale to return to normal counting mode.

(VII) Label format setting (available when a label printer is connected.)

1. Keep pressing **ENTER** key in USER PROGRAMMING FUNCTION MODE and release until the following displays appear.

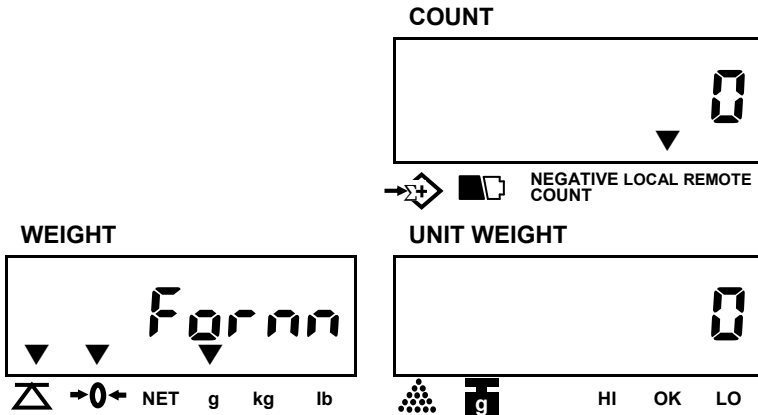

2. Press **MOVE** key to revolve the system-preset file name of the format. (**Default setting:** 0)
Options: form 0 ~ 9
 3. Press **ENTER** key to determine and return to next setting.
- ★ **Turn off the scale to return to normal counting mode.**

(VIII) Check alarm type

1. Keep pressing **ENTER** key in USER PROGRAMMING FUNCTION MODE and release until the following displays appear.

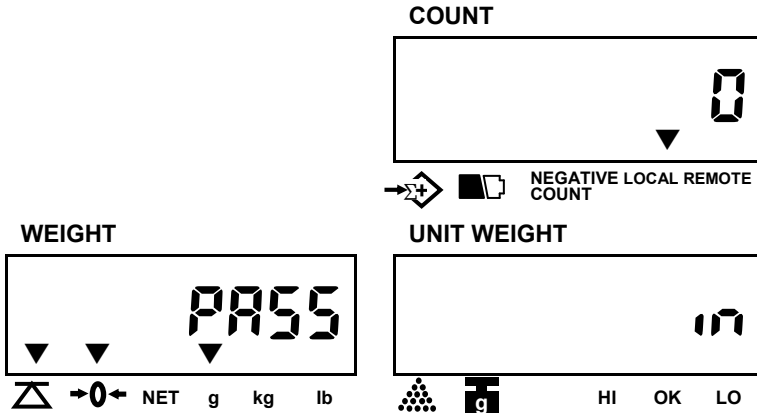

2. Press **MOVE** key to revolve the system-preset check alarm types. (**Default setting:0**)
in – Inside type, out– Outside type
3. Press **CLEAR** key to determine and return to normal counting mode or press **ENTER** key for determination and move to next.

Inside type

The alarm sounds beeps only when either total weight or total count falls inside the set range.

Ex. 1 Counting check alarms (Quantity in COUNT window blinks).

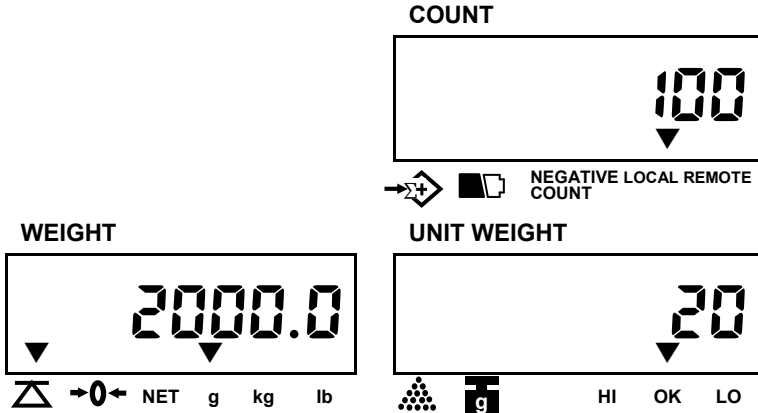

EX. 2 Weight check alarms (Weight in WEIGHT window blinks)

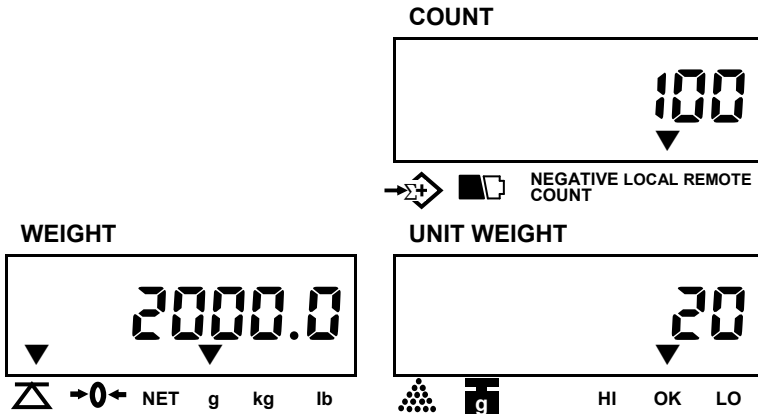

Outside type

The alarm sounds beeps only when either total weight or total count falls outside the set range.

Ex. 1 Counting check alarms

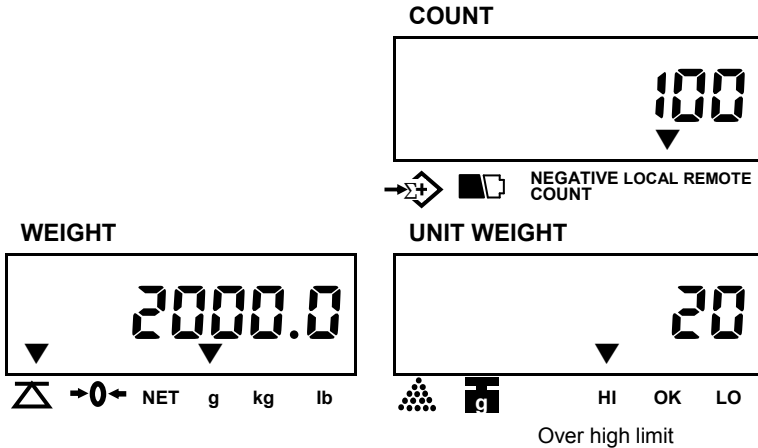

Ex. 2 Weight check alarms

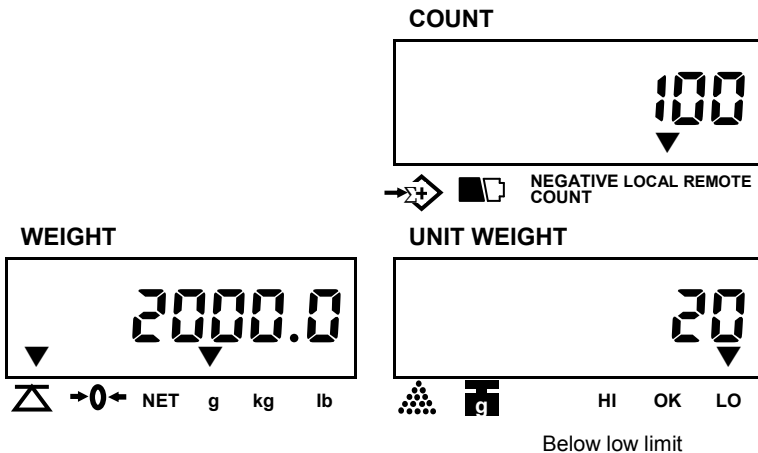

★ Turn off the scale to return to normal counting mode.

(IX) Cancel Tare setting

1. Keep pressing **ENTER** key in USER PROGRAMMING FUNCTION MODE and release until the following displays appear.

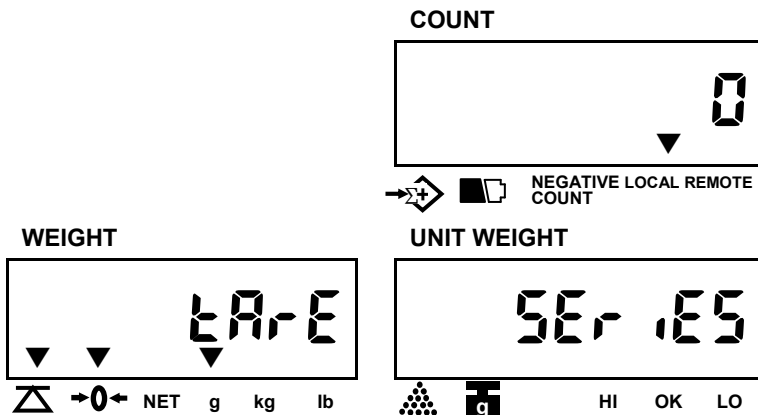

2. Press **MOVE** key to revolve the system-preset Cancel tare mode.

(Default setting: 5E- .E5)

“5E- .E5” – The tare weight can be canceled continuously.

“ONE” – The tare weight must be canceled for one time only.

(Note: If the canceled tare is not the value tared, then the buzzer will tweet for three times to indicate the error. Remove all the weight from the pan and then press TARE key or turn off and turn on the scale to solve the error.)

3. Press **CLEAR** key to determine and return to normal counting mode or press **ENTER** key for determination and move to next.

★ **Turn off the scale to return to normal counting mode.**

(X) Remote platform setting

1. Keep pressing **ENTER** key in USER PROGRAMMING FUNCTION MODE and release until the following displays appear.

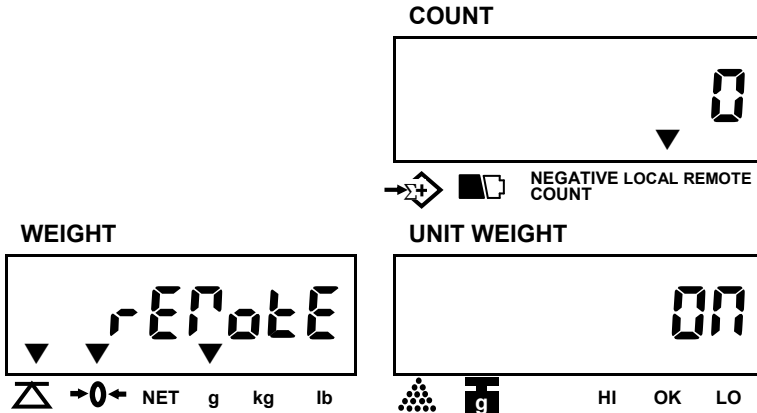

2. Press **MOVE** key to revolve the system-preset remote platform(on, off).
(Default setting:on)
If this setting is set to be “off”, the platform can't be changed.
3. Press **CLEAR** key to determine and return to normal counting mode or press **ENTER** key for determination and move to next.

(XI) Three section control signal

1. Keep pressing **ENTER** key in USER PROGRAMMING FUNCTION MODE and release until the following displays appear.

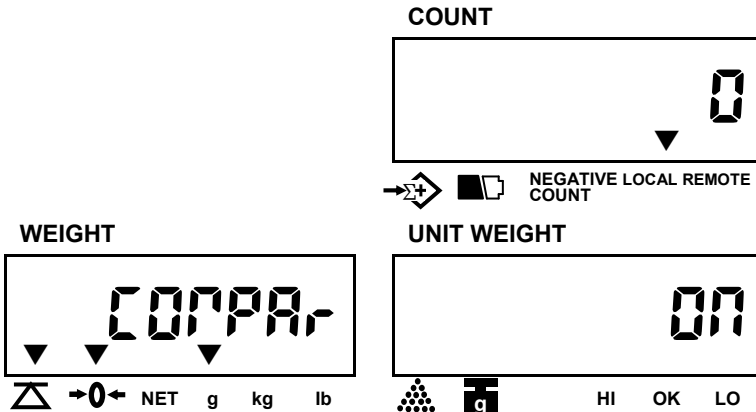

2. Press **MOVE** key to revolve the system-preset three section control signal.(on, off)

(Default setting:on)

If it is set to be “off”, the scale can’t transmit control signals.

3. Press **CLEAR** key to determine and return to normal counting mode or press **ENTER** key for determination and move to the next.

(XII) Transmit method of extra display

1. Keep pressing **ENTER** key in USER PROGRAMMING FUNCTION MODE and release until the following displays appear.

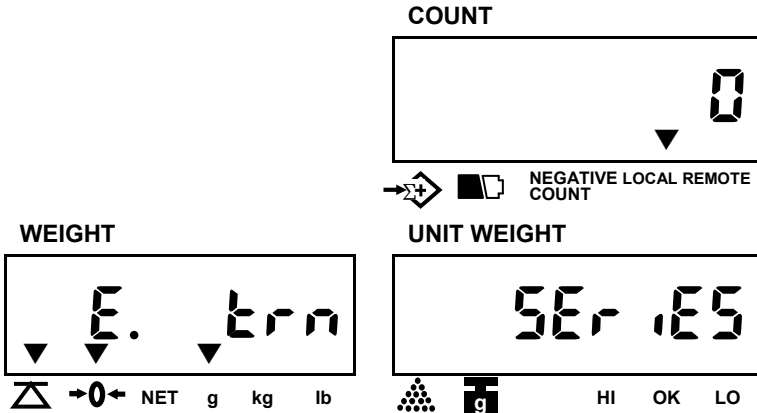

2. Press **MOVE** key to revolve the system-preset the transmit method of extra display.(StABLE. SEr .E5)

(Default setting: StABLE).

“SEr .E5” = Series transmit

“StABLE” = Stable transmit

3. Press **CLEAR** key to determine and return to normal counting mode or press **ENTER** key for determination and move to the next.

(XIII) Baud rate setting of extra display

1. Keep pressing **ENTER** key in USER PROGRAMMING FUNCTION MODE and release until the following displays appear.

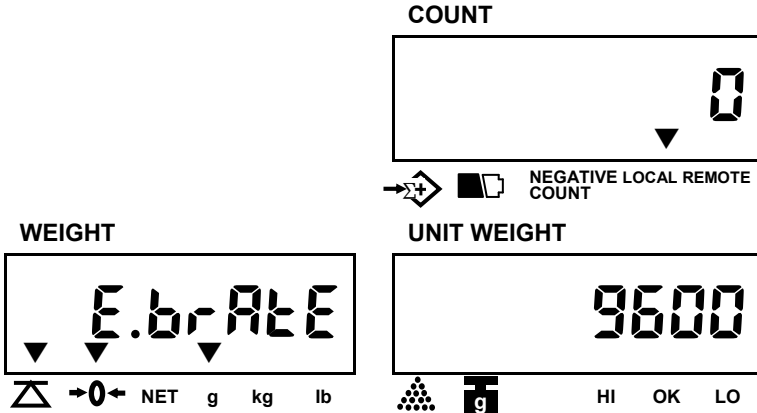

2. Press **MOVE** key to revolve the system-preset the baud rate of extra display.(2400, 4800, 9600)
(Default setting: 9600)
3. Press **CLEAR** key to determine and return to normal counting mode or press **ENTER** key for determination and move to the next.

(IXV) Zero Tracking Range

1. Keep pressing **ENTER** key in USER PROGRAMMING FUNCTION MODE and release until the following displays appear.

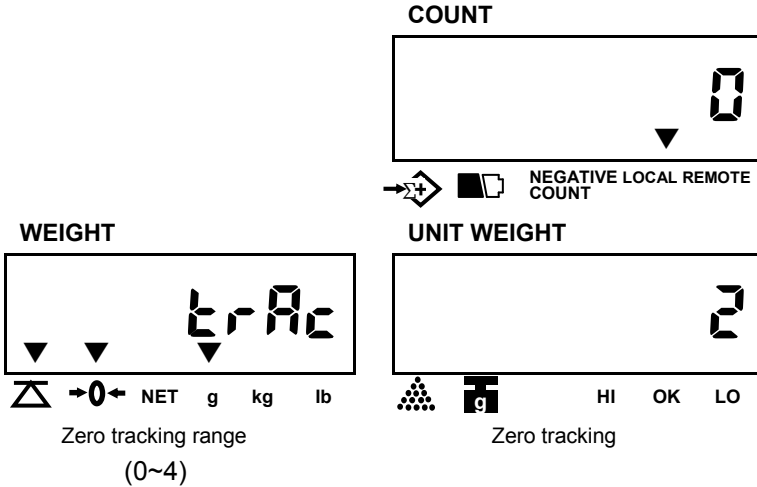

2. Press **MOVE** key to revolve the system-preset zero tracking range.
The larger number selected, the wider range (0=off, 1=0.5d, 2=1d, 3=2d, 4=3d).
(Default setting: 2)
 3. Press **CLEAR** key to determine and return to normal counting mode or press **ENTER** key for determination and move to next.
- ★ Turn off the scale to return to normal counting mode.

(XV) Zero display range

1. Keep pressing **ENTER** key in USER PROGRAMMING FUNCTION MODE and release until the following displays appear.

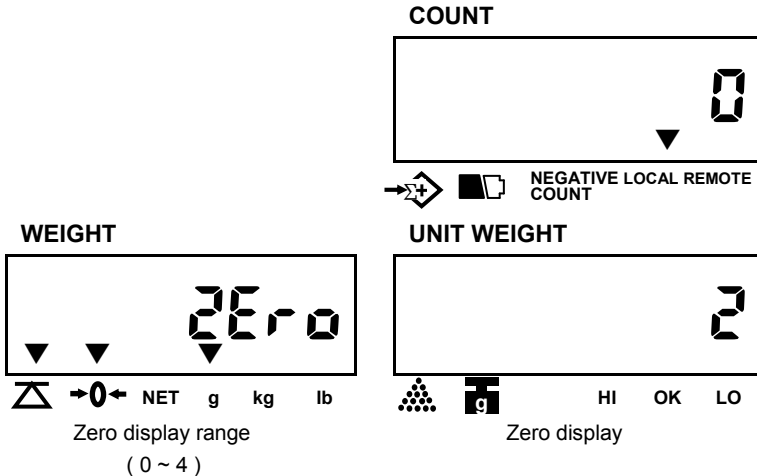

2. Press **MOVE** key to revolve the system-preset zero display range (0=off, 1=0.5d, 2=1d, 3=2d, 4=3d).
(Default setting: 2)
The larger number selected the wider range.
 3. Press **CLEAR** key to determine and return to normal counting mode or press **ENTER** key for determination and move to next.
- ★ Turn off the scale to return to normal counting mode.

(XVI) Stable class range

1. Keep pressing **ENTER** key in USER PROGRAMMING FUNCTION MODE and release until the following displays appear.

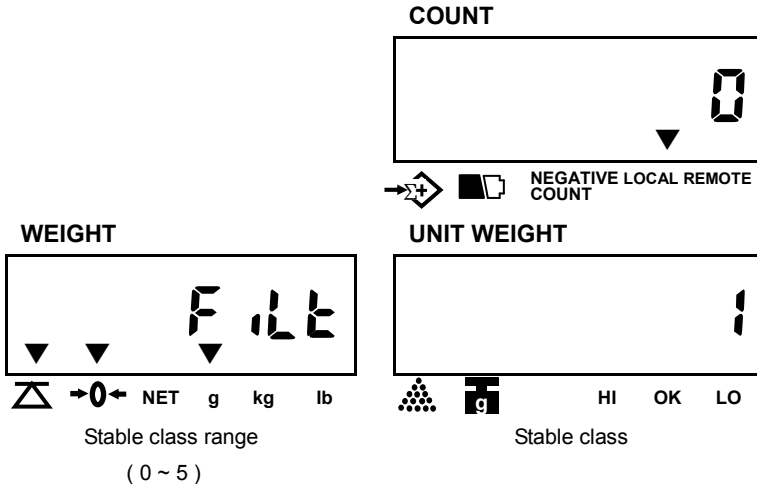

2. Press **MOVE** key to revolve the system-preset stable class range. The smaller number selected, the shorter time for display stability (0=off, 1=0.05d, 2=0.15d, 3=0.25d, 4=0.35d, 5=0.45d).

(Default setting: 1)

3. Press **CLEAR** key to determine and return to normal counting mode or press **ENTER** key for determination and move to next.

★ Turn off the scale to return to normal counting mode.

(XVII) Stable class rate

1. Keep pressing **ENTER** key in USER PROGRAMMING FUNCTION MODE and release until the following displays appear.

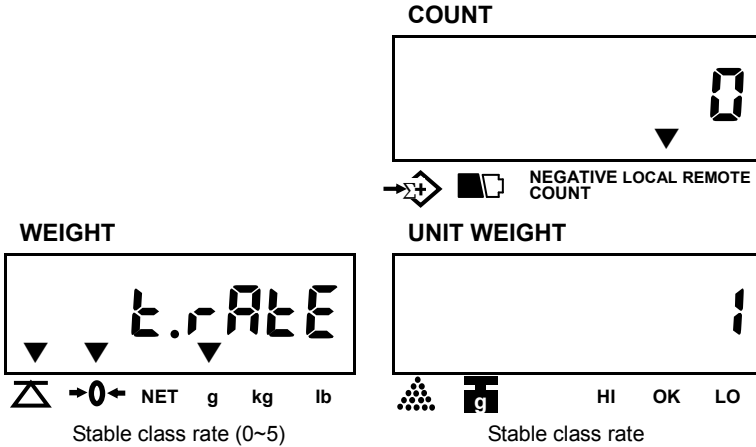

2. Press **MOVE** key to revolve the Stable Class Rate range
The larger number selected, the more stable zero point (level: 0, 1, 2, 3, 4, 5). (**Default setting:** 1)
3. Press **CLEAR** key to determine and return to normal counting mode or press **ENTER** key for determination and move to next.

★ **Turn off the scale to return to normal counting mode.**

VIII. Calibration

1. Turn on the scale, and key in "000419" during counting down (self-check) to zero to enter into Simple Calibration mode.

The displays will indicate as below.

Press **MOVE** key to choose the target platform(local or remote).

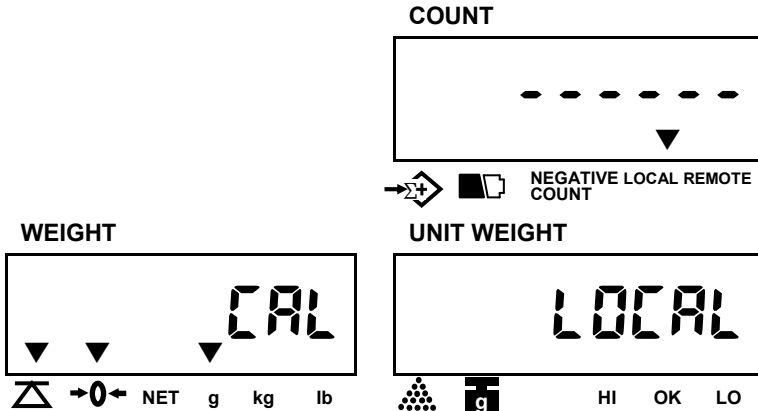

Then press **ENTER** key for determination and enter into unit selection.

2. Press **MOVE** key to choose the unit for calibration (kg/g or lb).

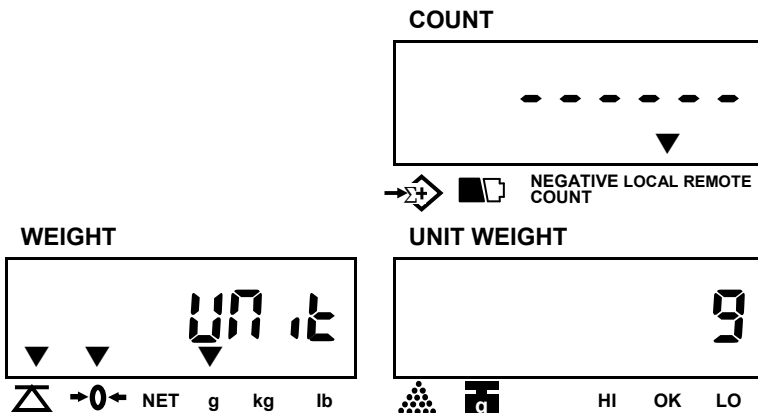

Press **ENTER** key for determination and enter into calibration mode.

Note: The weighing unit for Local platform is g or lb, while the

unit for Remote platform is kg or lb.

3. The default setting is 1/3 capacity(Take 6kg scale for instance)

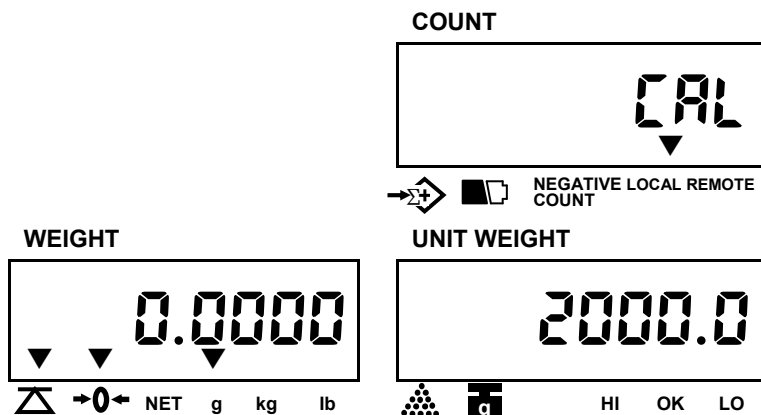

4. Put a weight on the pan same as what exactly shown in the UNIT WEIGHT window, then press the **ENTER** key to confirm the operation.

The displayed reading in the UNIT WEIGHT window starts blinking. The scale will stop blinking and return to normal counting mode.

Calibration is now completed.

Note:

★ Press **CLEAR** key to escape from calibration mode at any time.

★ **Change calibration value**

After entering the third step, press **MOVE** key. Use numeric keys to input a calibration value r (0.80000~1.20000). Press **ENTER** key to confirm, then the calibration is finished.

※ $r = \text{Mass weight} / \text{Display weight}$

IX. Power supply & battery operation

POWER SUPPLY

- a) AC Adaptor
- b) DC 12V/800mA or 12V/1000 mA

BATTERY OPERATION

The scale can be operated from the battery if desired. The battery life is approximately 80 hours.

When the battery needs charging a symbol “” on the COUNT display will turn on. The scale can keep operating for about 10 hours when the symbol appears. The scale will automatically switch off to protect the battery. Before switching off automatically, a prompt words “Lobat off” will be shown three times to indicate the scale switch off due to battery empty.

To charge the battery, connect the power adapter, and turn on the switch on the right side of the scale.

The battery should be charged for 12 hours for full capacity.

There is an LED to indicate the status of battery charging on the display. If the LED is **Green** the battery has been charged. If it is **Red** the battery is nearly discharged and **Yellow** indicates the battery is increasing the charge level.

As the battery is used it may fail to hold a full charge. If the battery life becomes unacceptable then contact your distributor.

Note: The battery should be recharged every 3 months if the scale is not used for long time.

X. RS-232 Output

The scale can be ordered with as standard RS-232 output.

1. Mode E1A-RS 232C's UART signal
2. Format:

Baud rate: 9600 BPS
 Data bits: 8 BITS
 Stop bit: 1 BIT
 Code ASCII
 Connector:9 Pin Socket
 Pin2 Input
 Pin3 Output
 Pin5 Signal Ground

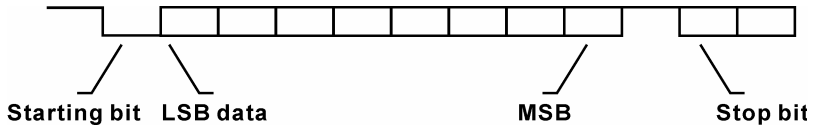

Data digit specification	1 2 3 4 5	6	7 8 9 10 11 12 13	14 15 16	17 18
1 st row: Net weight-Data	title	space	data	unit	CR
2 nd row: Unit weight-data	title	space	data	unit	CR
3 rd row: Quantity-data	title	space	data	CR(14 15)	
4 th row: Tare weight-data	title	space	data	weight	CR
4 th row data.	OA				

NET--stable Net Weight

net--unstable NetWeight

PCS--stable Quantity

pcs--unstable Quantity

Tare--Tare Value

UW--Unit Weight

CR: OD OA

Note: The new line demands" OA"will appear when the total data has been transmitted.

3. Data Format of Series transmit:

- When scale is in stable mode:

NET: 2.0000 kg

U/W: 10 g

PCS: 200

Tare: 0.0800 kg

- When scale is in unstable mode:

net: 2.0000 kg

U/W: 10 g

pcs: 200

Tare: 0.0800 kg

net=unstable Net Weight NET=stable Net Weight

pcs=unstable Quantity PCS=stable Quantity

U/W=Unit Weight Tare=Tare Value

4. Transmit Format, when it is in Accumulation model and transmit by pressing “**ADD**” key and “**TOTAL**” key. At the same time, Item number is stored in memory. (Please refer to Page 8 (IV) of section IV, Preset unit weight in numeric keys)

Press the **ADD** key

PLU100

No. 800125

I.N. Register

Record#01

NET: 2.0000 kg

U/W: 10 g

PCS: 200

Tare: 0.0350 kg

Press the **ADD** key again

PLU100

No. 800125

I.N. Register

Record#02

NET: 3.0000 kg

U/W: 10 g

PCS: 300

Tare: 0.0350 kg

Press the **TOTAL** key

TOTAL

PLU100

No. 800125

I.N. Register

NET: 5.0000 kg

PCS: 500

NET=stable Net Weight PCS=stable Quantity

U/W=Unit Weight Tare=Tare Value

Note: When it is in normal counting mode (without accumulation operation), press the “**TOTAL**” key to print the data, the transmit format is as below:

- When scale is in stable mode:

TOTAL

NET: 5.0000 kg

U/W: 10 g

PCS: 500

Tare: 0.8000 kg

- When scale is in unstable mode:

TOTAL

net: 5.0000 kg

U/W: 10 g

pcs: 500

Tare: 0.8000 kg

net=unstable Net Weight NET=stable Net Weight

pcs=unstable Quantity PCS=stable Quantity

U/W=Unit Weight Tare=Tare Value

Note: If the unit weight information is recalled from the memory, PLU code, Item Number and Item name should be printed out.

5. Variables (The prompt character) used in scale also in label printer

Variable Name	Specifications	Size
SER	Accumulated times (Weight)	2 byte
NWA	Net weight (with dot ".")	7 byte
NWB	Net weight(no dot)	6 byte
NWC	Net weight (with comma ",")	7 byte
TWA	Tare weight (with dot ".")	7 byte
TWB	Tare weight (no dot)	6 byte
TWC	Tare weight (with comma ",")	7 byte
GWA	Gross weight (with dot ".")	7 byte
GWB	Gross weight (no dot)	6 byte
GWC	Gross weight (with comma ",")	7 byte
TNA	Total net weight (with dot ".")	7 byte
TNB	Total net weight(no dot)	6 byte
TNC	Total net weight (with comma ",")	7 byte
UWA	Unit weight (with dot ".")	7 byte
UWB	Unit weight (no dot)	6 byte
UWC	Unit weight (with dot ",")	7 byte
QUA	Quantity (with dot ".")	7 byte
QUB	Quantity (no dot)	6 byte
QUC	Quantity (with comma ",")	7 byte
TQA	Total Quantity (with dot ".")	7 byte
TQB	Total Quantity (no dot)	6 byte
TQC	Total Quantity (with comma ",")	7 byte
UNT	Weighing Unit	2 byte
AN	Address number	3 byte
IN	Item number	6 byte
INA	Item name	16 byte

- Note:**
- 1) Capital Letters are allowed for the Variable Name only.
 - 2) A value "0" will be given when the value exceeds the display range.

6. Command (PC -> Scale)

Command(1byte)		Weighing Mode
Char.	HEX	
1	0X31	Same as numerical key 1
2	0X32	Same as numerical key 2
3	0X33	Same as numerical key 3
4	0X34	Same as numerical key 4
5	0X35	Same as numerical key 5
6	0X36	Same as numerical key 6
7	0X37	Same as numerical key 7
8	0X38	Same as numerical key 8
9	0X39	Same as numerical key 9
0	0X30	Same as numerical key 0
.	0X2E	Same as decimal point key “.”
S (s)	0x53	Same as C key
	0x73	
C (c)	0x43	Same as SAMPLE Key
	0x63	
O (o)	0x4F	Same as SET Key
	0x6F	
M (m)	0x4D	Same as MOVE Key
	0x6D	
U (u)	0x55	Same as U.W key
	0x75	
A (a)	0x41	Same as PRINT Key
	0x61	
E (e)	0x45	Same as ENTER Key
	0x65	
R (r)	0x52	Same as MEMORY key
	0x72	

Command(1byte)		Weighing mode
Char.	HEX	
G (g)	0x50	Same as GROSS key
	0x70	
N (n)	0x4E	Same as ADD key
	0x6E	
Z (z)	0x5A	Same as ZERO key
	0x7A	
T (t)	0x54	Same as TARE key
	0x74	
D (d)	0x44	Same as TOTAL key
	0x64	
L (l)	0x4C	Same as long press MEMORY key
	0x6C	

XI. Error Codes

During the initial power-on testing it is possible the scale may show error message.

The meaning of the error messages is described below.

ERROR CODE	POSSIBLE CAUSES	HANDLING
E1	The scale hasn't be calibrated before or calibration data lost.	Calibrate the scale.
E2	EPROM data lost.	Recalibrate the scale.
E3	Remote platform is not well connected with the scale when powers on.	Connect the remote platform properly and switch on again.
	1.Local platform is not placed well. 2.There are something heavy touch the pan.	1.Place the pan well and switch on again.. 2.Remove the weight and switch on again.
E4	Address code of Unit Weight is out of "1~200".	Correct the operation.
E5	In alarm setting, the LO value is set higher than HI value.	Correct the operation.
--OL--	Overload	Take off the weight immediately.
	Low battery	Charge the battery.

If the error message is still shown after above ways, please recalibrate. If the problem still can not be solved then contact your dealer for further support.

XII. Technical Data

g Version	Capacity	3000g	6000g	15000g	30000g
	Readability(e=d)	0.1g	0.2g	0.5g	1g
lb Version	Capacity	6lb	15lb	30lb	60lb
	Readability(e=d)	0.0002lb	0.0005lb	0.001lb	0.002lb
External Resolution		1/30,000			
Internal Resolution		1/600,000			
Min Recommended Lack of Sample Weight		1g	2g	5g	10g
		0.002lb	0.005lb	0.01lb	0.02lb
Min Recommended Lack of Unit Weight		0.01g	0.02g	0.05g	0.1g
		0.00002lb	0.00005lb	0.0001lb	0.0002lb
Tare Range		0~3000g	0~6000g	0~15000g	0~30000g
Display Type		LCD			
Weight Units		g /kg or lb			
Zero Range		±2%			
Stabilization Time		≤2 seconds			
Output Ports		RS232 port: Can be connected with PC, printer, etc.			
		Remote port: Can be connected to a extra display or remote platform with up to 4 pcs of load cell (weighing range 0~10t) ※ Remote Spec:1.0mv/v~3.3mv/v			
		Serial port: Can be connected to an extra display or control box(output three section control signal)			
Operation Temperature		0℃ ~ 40℃ /32℉ ~ 104 ℉			
Humidity Range		≤90% relative humidity, non-condensing			
Power		AC Adaptor DC 12V/1A or 12V/800mA			
		Internal rechargeable sealed acid battery			
Battery Life		80 hours continuous use with 12 hour recharge time			
Calibration		Automatic external with kg/lb mass, factory calibration recovery			
Safe Overload Capacity		120% of capacity			
Product weight		4.5kg / 9.9lb			
Dimension(mm / inch)		330(W) x 346(D) x 107(H) /			
Pan Size(mm / inch)		306(W) x 222(D) / 12.0 (W) x 8.7 (D)			

