



**ATS**



**BTS**

---

# Instruction Manual: ATS & BTS Moisture Analyzers



## Table of Contents

1. Cautionary Notes	2
1.1 Important Safety Warnings	2
1.2 Hot Parts and Surfaces	4
1.3 More Cautionary Notes and Precautions	5
2. Specifications	6
3. Introduction	7
4. Keys and Display Indicators	8
5. Parts Description	9
6. Unpacking and Getting Started	10
7. Main Menu	11
8. Configuring Drying Settings and Understanding the parameters	12
8.1 Configuring Drying Settings	12
8.2 Saving drying settings	12
8.3 Understanding drying parameters and settings	13
9. Preparing the Sample	15
10. Performing Moisture Analysis	16
11. Determining Drying Parameters for Unknown Samples	18
11.1 Activating the Drying Chart	18
11.2 Setting trial parameters and performing trial-and-error analysis	19
11.3 Interpreting the Trial Analysis, making adjustments, and finalizing the settings	19
12. Loading Saved Profiles and Parameters	20
13. Temperature Correction and Adjustment	21
13.1 Installing the external temperature probe	21
13.2 Obtaining temperature correction readings and enabling Temperature Correction	22
14. Drying Options	23
15. Report Printing Configuration and Data Transmission	24
16. RS232 (Port 1) and USB (Port 2) Interface Ports	25
17. Configuration	26
18. Restoring Factory Defaults	27
19. Testing the Analyzer with Sodium Tartrate Dihydrate	28
20. Replacing the Halogen Lamps and cleaning the chamber	29
21. Calibration	30
22. Weighing	32
22.1 Taring	32
22.2 Clearing a Tare	33
23. Common Errors and Troubleshooting	34
24. Warranty	35
25. Drying parameters for common materials and substances	36

## Chapter 1: Cautionary Notes

The TORBAL Moisture Analyzer is a sensitive and a delicate instrument that generates heat up to 160°C. Many parts and surfaces of the moisture analyzer get extremely HOT. Always handle the analyzer with care and use EXCESSIVE CAUTION when operating the moisture analyzer.

### 1.1 Important Safety Warnings:

#### WARNING:

- Do not test flammables, explosives, or things that produce dangerous or noxious vapors.
- Do not test unknown substances.
- Do not place anything on top of the analyzer's venting grill (perforated top cover of the unit).
- Do not pass anything over the top of the unit when drying is in progress. Never pass fluids over the perforated cover (a spill can be disastrous).
- If a sample catches fire, first pull the power plug from the power outlet, and then extinguish the flame.
- Always assume the Drying Chamber is hot when you open the cover. As the internal parts can retain heat, allow adequate time for cooling before touching any of the internal surfaces.
- Never touch a halogen lamp unless you are about to replace it, and you are sure the analyzer is off and halogens have cooled down.



## WARNING:

- **If a mistake creates a dangerous situation, immediately press the STOP key to terminate the drying.**
- **Use extreme caution when touching parts of the analyzer they may be very HOT. Wear protective gloves when removing hot samples, even when using the pan handle (it can get very hot).**
- **Use the cover handle to open and close the Drying Chamber.**
- **Always use forceps or needle-nose pliers to remove the hot disposable sample pan from the larger permanent pan.**
- **When loading a new sample into the Drying Chamber use the pan handle. Make sure the disposable sample pan and sample are centered and that the sample has been leveled.**
- **Be sure the Analyzer is in an area with good air circulation (to diffuse the heat generated by the Drying Chamber or vapors generated from your sample), relatively low (less than 85%) or controlled humidity (for accurate measurements), and an ambient temperature between 18°C and 30°C.**
- **If you suspect that the analyzer has malfunctioned or it is not operating properly, immediately STOP use and contact technical support.**

	<p>Legal regulations forbid disposal of electronic equipment in waste containers.</p>
<ul style="list-style-type: none"><li>• Please return this device to the point of purchase or another company that specializes in recycling of waste electronic components.</li></ul>	

## 1.2 Hot Parts and Surfaces

Many parts of the Moisture Analyzer get very **HOT** during use. Familiarize yourself with these internal parts and always allow adequate time for cooling before touching or handling. Never touch any areas of the analyzer that with hot symbol.

The analyzer's venting grill can reach a temperature in excess of 100°C (212°F). **NEVER** touch the grill during or soon after use as severe burning may occur. The analyzer's housing can reach a temperature of 60°C (140°F).

Venting Grill can reach temperatures in excess of 100°C (212°F). **NEVER** touch the grill during or soon after use as severe burning may occur.

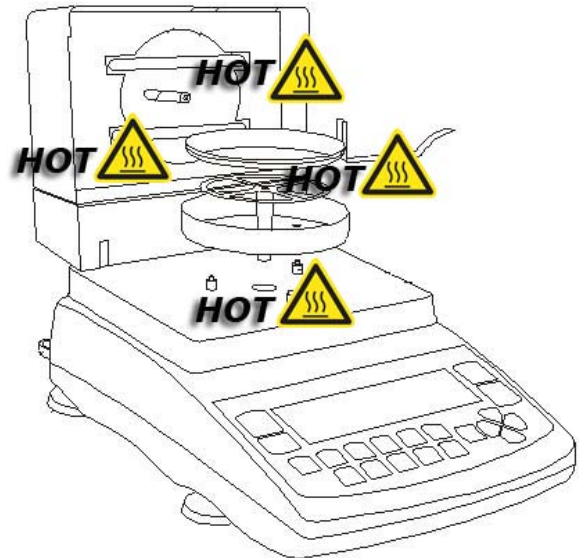

### 1.3 More Cautionary Notes and Precautions

Correct location and proper environment has a significant impact on the accuracy of the weighing results of the TORBAL Moisture Analyzer.

#### The optimal location for your unit:

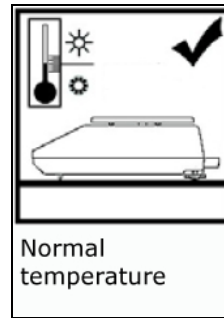

- Stable, vibration-free base as horizontal as possible
- Away from direct sunlight
- Not exposed to high temperature variations
- Away from direct drafts
- Best location: stable bench away from direct drafts, doors, windows, radiators, and air conditioner vents.

### WARNING:



- The Analyzer is designed for indoor use only.
- Do not operate the unit in hazardous areas or conditions.
- **Never Operate the Analyzer near combustive or explosive vapors**
- Do not use the Analyzer in locations subject to high humidity or dust levels.
- Do not connect cables in ways other than those designated in this manual.
- Be sure to set the Analyzer on a firm, stable horizontal surface.
- Never stand on or lean on this product. Equipment may fall or collapse, causing breakage and possible injury.
- Before moving the product, unplug it and unplug all cables connected to it.
- When storing, transporting, or returning the unit for service, always use the original packaging.

### WARNING:



- **Never attempt to repair, disassemble, or modify the Analyzer yourself. Tampering with the unit may result in injury and cause more damage to the equipment.**
- **Never use different halogens than what is specified in operators manual**
- Be sure to use the specified power source.
- Do not allow foreign matter to fall into the unit.
- If water or other liquid spills into the Analyzer, do not continue to use it. Unplug the power cord immediately and contact technical support.



## Chapter 2: Specifications

	Model		
	ATS60	ATS120	BTS110
Maximum Capacity	50g	100g	110g
Readability (d)	0.001g		0.01g
Repeatability (Standard Deviation)	0.001g		0.01g
Linearity	+/- 0.002g		+/- 0.02g
Tare Range	-60g	-120g	-110
Accuracy Class	II		III
Calibration Weight	10g, 20, 50g	20g, 50g, 100g	20g, 50g, 100g
Operating Temperature	+18C to +33C		
Analyzer Resolution	0.01%		0.1%
Moisture Measurement Repeatability	+/-0.1% (2g sample) +/-0.04% (5g sample)		+/-1% (2g sample) +/-0.4% (5g sample)
Maximum Drying Temperature	160°C		
Maximum Drying Time	9 hours		
Drying Power	200W (2 x 100W)		
Halogen Size	78mm, 100W		
Warm-up time	Approximately 90 sec.		
RS232C Port	DB9 Female		
USB Port	B Type		
PS2	External Keyboard		
Pan Size	90mm		
Dimensions	185mm x 290mm x 170mm (7.3" x 11.4" x 6.7")		
Unit Weight	3.9kg (8.5lbs)		2.8kg (6.2lbs)
Power	110VAC, 60Hz		
Warranty	12 months		



## Chapter 3: Introduction

### 3.1. Function of the Moisture Analyzer

- The primary function of the device is to make precise measurements that allow the user to determine the moisture content of various materials using the principle of thermo-gravimetric analysis – mass loss of a sample caused by rapid drying due to an increase in temperature.
- Drying and configuration parameters such as the drying time, temperature, and sample weight, are determined by the user. Parameter should be established by evaluating the physiochemical properties of a the sample which will undergo the analysis. Optimum configuration parameters are also often derived through trial-and-error.

### 3.2. Good Practices and General Rules

- Larger samples take longer to dry, but produce more accurate results. When accurate results are required, try to stay in the 5 to 15 gram range. Use the Drying Chart feature to help in optimizing the Sample Size, Drying Time, and Temperature.
- For uniformity of results, it is better to set the Drying Time for a little longer rather than shorter.
- Lower temperatures take longer, but produce more uniform results in many materials. This is especially true if thermal decomposition is encountered in which added moisture is driven off as drying continues because of decomposition.
- Prepare the sample properly. This includes: obtaining uniformity of initial weight, leveling the sample, using a glass fiber disc with fluid samples or samples that produce fluids when heated, and avoiding carbonization of the sample when possible (lower heat helps).
- Prepare the sample quickly and get it into analysis before its moisture content is altered by its surroundings.
- The more samples tested, the better the statistical reliability of the results.
- If solvents are required, be very careful of the vapors produced—they can be flammable or even explosive. Safety first!
- Keep the Analyzer clean, keep the area around the Analyzer clear, calibrate the weighing unit periodically, and test the unit for moisture accuracy using the Sodium Tartrate Dihydrate chemical standard whenever problems are suspected (or periodically).
- Above all, remember the Drying Chamber can run at high temperatures, so use caution whenever opening the cover or handling sample pans. The internal surfaces retain heat for some time.



## Chapter 4: Keys and Display Indicators

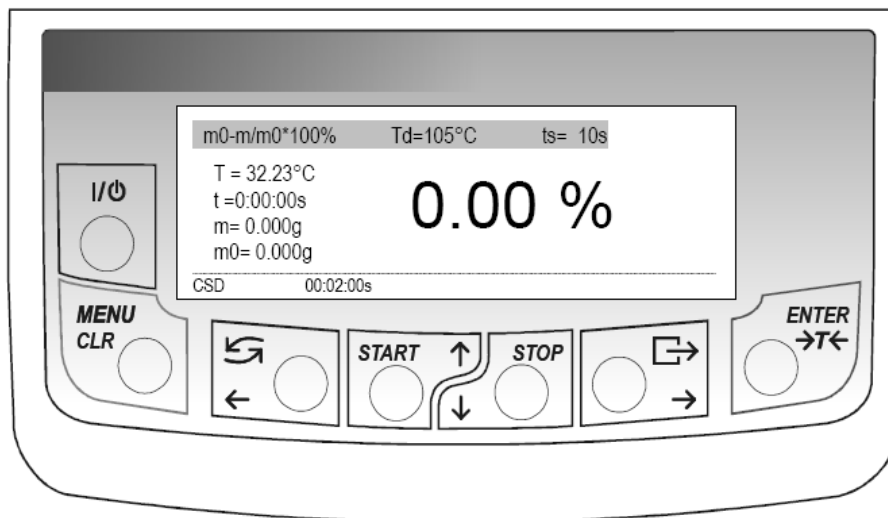

Key	Primary Function	Secondary Function
	Turns analyzer ON / OFF	n/a
ENTER →T←	Tare – tares gross weight / zero the scale	Enter – used to enter menu folders and accept commands
MENU CLR	Menu – accesses the Main Menu	Clear and Exit
START ↑	Starts moisture analysis	UP navigation key
STOP ↓	Stops moisture analysis	DOWN navigation key
	Function toggle key - Weighing / Drying	LEFT navigation key
	Data Transfer / Print	RIGHT navigation key
Display Indicator	Description	
$m_0 - m/m_0 * 100\%$	Calculation formula used for calculating the result	
Td	Set Drying time	
ts	Set Sampling Interval	
T	Current Temperature in the drying chamber	
m	Current weight	
m0	Initial starting weight	
t	Current drying time	
	Current drying profile in use	
CSD / OPEN	Drying Chamber Closed / Drying Chamber Open	
00:02:00s	Drying Time	
Command or Abbreviation	Description	
Drying temp.	Drying Temperature	
Sampling Interv.	Sampling Interval	

## Chapter 5: Parts Description

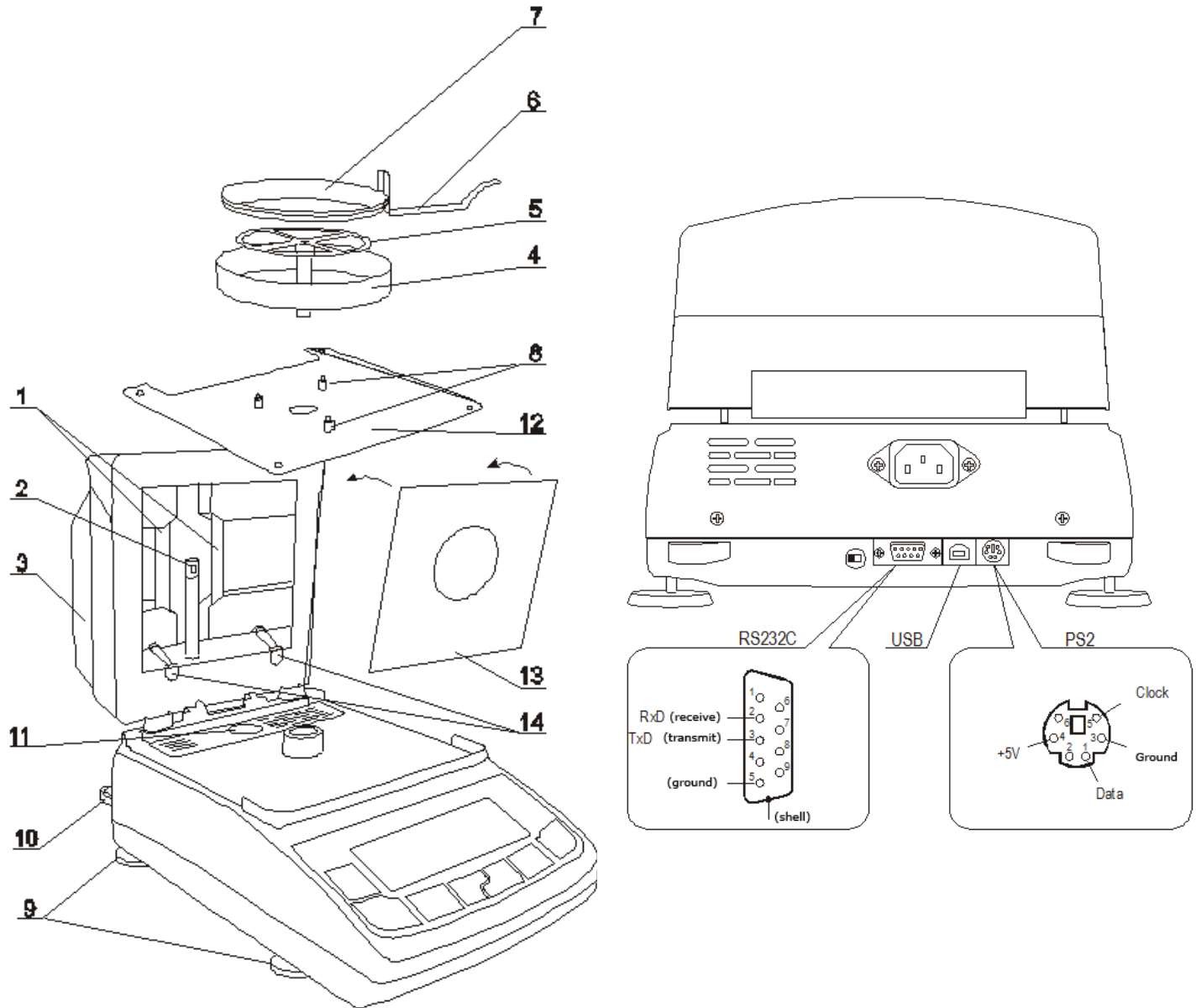

<b>1</b>	Halogen Lamps	<b>8</b>	Pan Shield Posts
<b>2</b>	Temperature Sensor	<b>9</b>	Adjustable Leveling Feet
<b>3</b>	Drying Chamber	<b>10</b>	Bubble Level Indicator
<b>4</b>	Pan Shield	<b>11</b>	Fuse
<b>5</b>	Pan Support	<b>12</b>	Base Plate
<b>6</b>	Pan Handle	<b>13</b>	Glass Plate
<b>7</b>	Disposable Pan	<b>14</b>	Latches

## Chapter 6: Unpacking and getting started

1. Carefully remove the Moisture Analyzer and all its components from the packaging and place them on a stable base where the unit will not be affected by any mechanical vibrations or air movements.
2. After removing the Pan Shield (4), Pan Support (5), and Pan Handle (6) from their packaging, open the Drying Chamber (3) and carefully install the Pan Shield (4) on the three Pan Shield Posts (8).
3. Once the Pan Shield is installed on the shield posts, gently insert the Pan Support (5) into the opening of the Analyzer's mechanism.
4. After installing the Pan Support, place a Disposable Pan (7) on the Pan Handle (6), then place it on the Pan Support so that the handle rests on the Pan Shield without touching the Pan Support.
5. After installing all pan components, close the Drying Chamber and level the Analyzer by adjusting the leveling feet until the level indicator shows the “air bubble” is in the center position of the sight glass. The level indicator is located on the rear left side of the unit.
6. After leveling the scale, plug the power supply cable into the power supply socket (Marked 110V) located in the rear of the Analyzer.
7. Make sure the drying chamber is closed, and then plug the power cable into the wall outlet.
8. When the cable is plugged into the wall outlet, the Analyzer will turn “ON” automatically and initialize itself. The Initial Heating is designed to drive any residual moisture from the heating chamber. The internal temperature is raised to 105°C.
9. Upon completion of the power-up sequence, the unit comes up in the Moisture Analyzer Mode and is then ready to be used.

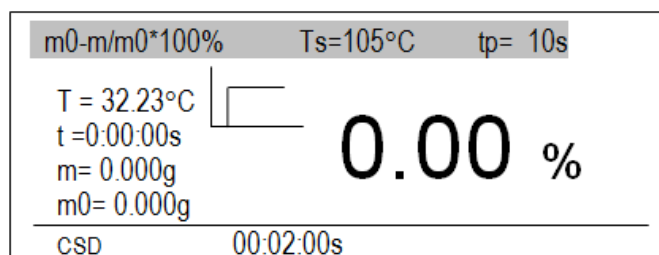
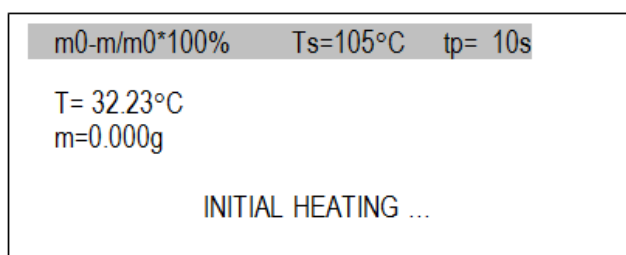

**WARNING: Please be careful and remember the drying chamber has been heated and will retain heat for some time.**



## Chapter 7: Main Menu

1. **Drying Settings:** Used to configure and define essential drying parameters and profiles which are necessary to perform moisture analysis.
2. **Memory Settings:** Allows to recall a previously saved set of parameters from the analyzers memory.
3. **Drying Options:** Allows to enable statistical information, as well as a drying chart which is often used when establishing drying parameters for unknown samples. The transmissions option allows to transmit samples which are taken during the moisture analysis. Data can be transferred to a PC or an external printer.
4. **Drying Report:** Used to configure and customize the drying report which can be printed at the end of each moisture analysis.
5. **Configuration:** Allows to configure the analyzers weighing function, as well as general settings such as Interface Ports (RS232 and USB), LCD Contrast, Time and Date, and Calibration.
6. **Settings Default:** Restores all factory settings and parameters

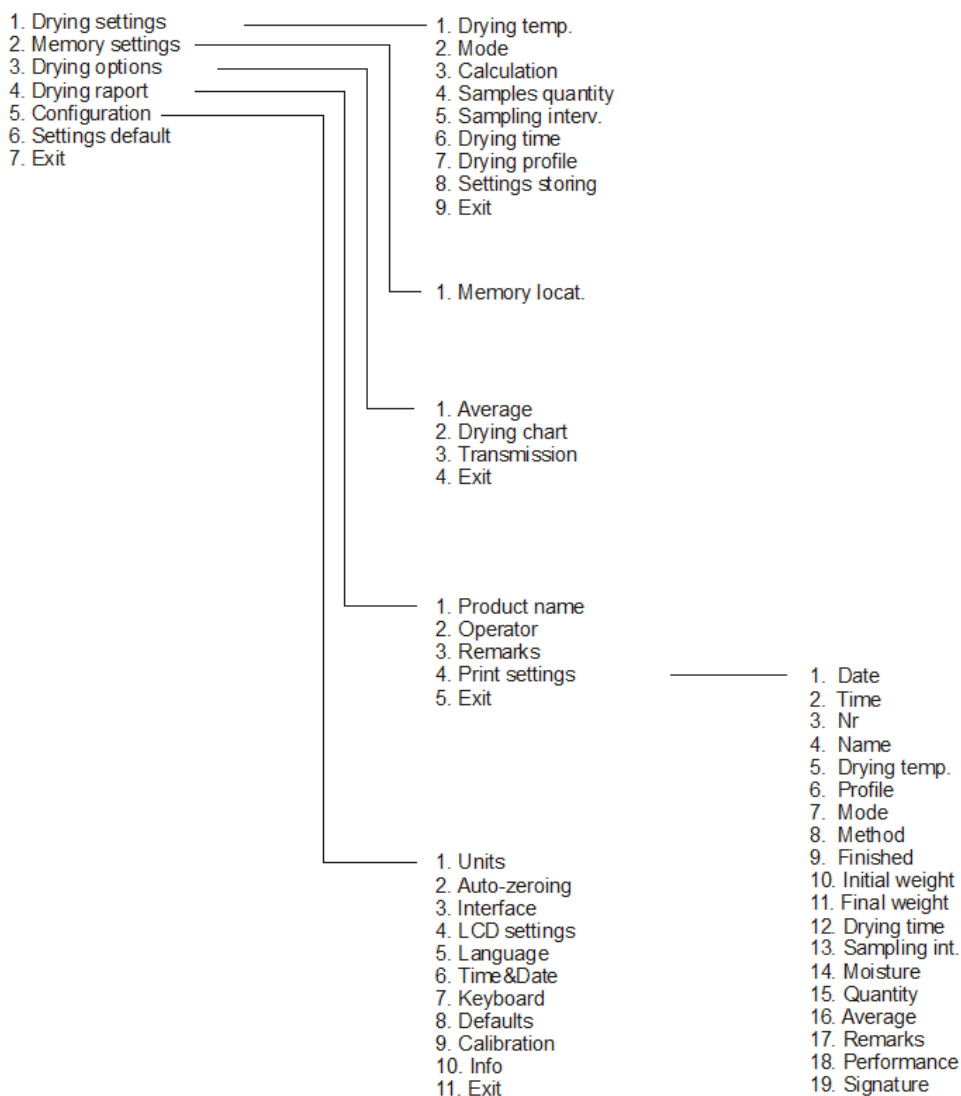

# Chapter 8: Configuring Drying Settings and Understanding the parameters

## 8.1. Configuring Drying Settings

1. Press the MENU key, then use the arrow keys to select “Drying Settings” and press ENTER.
2. Use the arrow keys to select parameters and input desired values. Press ENTER to accept and confirm a setting.



Note: Connecting a PS2 keyboard to the analyzer allows for faster data input and configuration.

USER MENU

1. Drying settings
2. Memory settings
3. Drying options
4. Drying r
5. Configu
6. Settings
7. Exit

DRYING SETTINGS

1. Drying temp.	:	160°C
2. Mode	:	short mode
3. Calculation	:	m0-m/m0*100%
4. Samples quantity	:	4
5. Sampling interv.	:	10s
6. Drying time	:	02:00:00s
7. Drying profile	:	Standard
8. Settings storing	:	1
9. Exit	:	

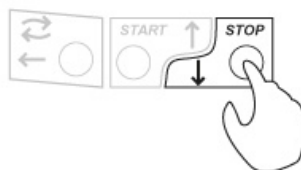

## 8.2. Saving drying settings

1. After configuring all settings, use option 8 (Settings storing) to select a desired memory location (1 of 20).
2. Proceed to option 9 (Exit) and press the Enter key. The analyzer will display “Save Setting?”
3. Use the arrow navigation keys to select “YES” and press the Enter key to confirm.

DRYING SETTINGS

2. Mode	:	short mode
3. Calculation	:	m0-m/m0*100%
4. Samples quantity	:	2 samples
5. Sampling	:	10s
6. Drying time	:	0:00:10s
7. Drying profile	:	standard
8. Settings storing	:	1
9. Exit	:	

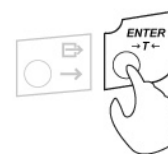

DRYING SETTINGS

Save settings?

NO  
**YES**

DRYING SETTINGS

Saving . . .

### 8.3. Understanding drying parameters and settings

1. **Drying Temperature** - maximum drying temperature which will be used to perform moisture analysis.

2. **Mode** - The analyzer can be used in two drying modes:

**Short Mode (Automatic):** Drying is terminated when the mass loss between successive samples taken during the moisture analysis (Sample Quantity) is smaller than the threshold value of 2mg.

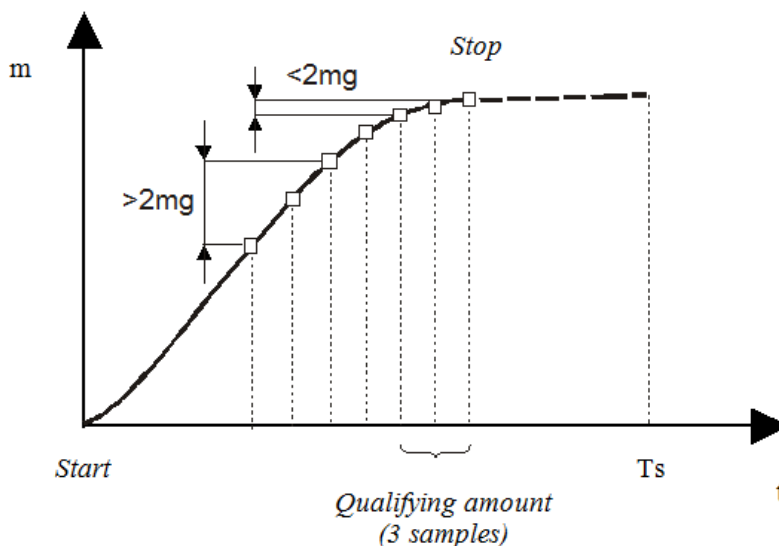

**Time Mode** – Drying is terminated when user defined time (Drying Time) is reached. The Drying time can range from 1second to 10 hours.

3. **Calculation** – results can be calculated and displayed using one of the three formulas:

$W [\%] = m_0 - m/m_0 * 100\%$ , where moisture is determined in relation to initial weight

$W [\%] = m_0 - m/m * 100\%$ , where moisture is determined in relation to current weight

$W [\%] = m/m_0 * 100\%$ , where current weight is determined as a percentage of sample weight

Where:  $m_0$  = initial (wet) weight,  $m$  = current weight, and  $W [\%]$  = moisture as a %

4. **Samples Quantity** – used and required when operating the analyzer in the Short Mode. The analyzer uses the setting to check whether the mass loss taken between the samples is less than 2mg. Higher number of samples taken allows for a more accurate determination.

5. **Sampling Interval** – time separation between each sample taken. This setting is used when operating the analyzer in the short mode and it can be optionally used in the time mode when tracking the progression in mass loss of the sample i.e. transmitting the sample mass to a printer or a PC.

6. **Drying time** – defines the total drying time for a sample when operating the analyzer in the Time Mode. When using the analyzer in the *Short Mode* the drying time should be set to 10 hours.
7. **Drying Profile** – one of four drying profiles can be selected when performing moisture analysis. Selecting a drying profile allows to optimize the analysis by adjusting the drying progress to the physical properties of the sample. Although most samples can be accurately analyzed with the standard profile, other may require a slow, stepping, or fast temperature progression. I.e. samples prone to natural evaporating or thickening may require the use of a slow or step profile. Samples that are resistant to temperature may require the use of a fast profile. Before selecting a profile perform trial analysis and tests to make sure the results are accurate and the sample responds to the selected profile appropriately.

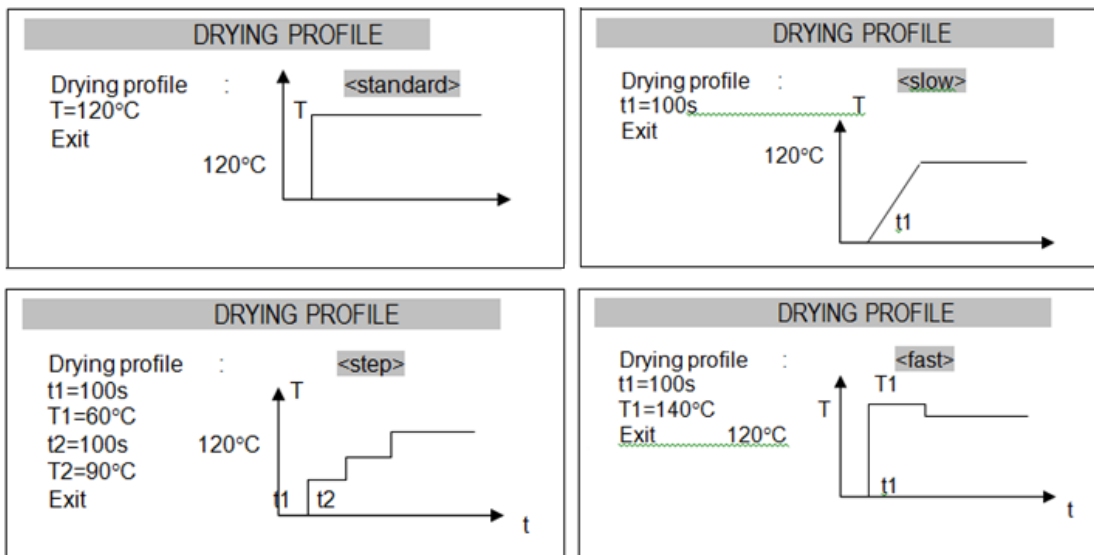

8. **Settings storing** – allows select one of 20 memory location for storing configured parameters. This feature is especial useful when analyzing samples that require different drying parameters.

## Chapter 9: Preparing the Sample

1. A sample of a given substance must be a good representation of the material. Drawing and preparing a sample is a very important process as it may affect the repeatability of measurements. The most common method of homogenizing a sample is mixing. Another method is to draw a few samples from different but specific points in a substance and calculate an average value, or to draw a few samples from different points in a substance, mix them, and draw a sample from the mixture.

**Note:** The sampling method depends on the type of research being performed. In quality control, usually many representative samples are analyzed. In production control, it is enough to confirm sampling repeatability.

2. When preparing a sample, it is important the sample does not absorb moisture from the surrounding environment – thus preparation time should be as short as possible.

**Note:** If necessary to analyze more than one sample at the same time, the samples should be placed in separate hermetically sealed plastic bags or containers. Make sure the sample does not lose moisture while it is inside the container (the container or plastic bag should not have much air in it).

3. Tools and instruments used in the preparation process may affect measurement accuracy. Do not use tools that transmit heat as this can cause the sample to lose moisture before the actual analysis. Use only special grinders and mixing instruments. When drawing a sample from a liquid containing solid materials, use a glass mixer, spoon, or magnetic mixer.
4. To analyze moisture content, place the sample on the disposable pan provided with the unit and place it in the dryer chamber. Using disposable pans helps to avoid the false results that may be caused by the residue left from previous samples.
5. A sample should be always thin and distributed uniformly throughout the pan so that the heat penetrates equally all over the sample and dries the entire sample effectively.

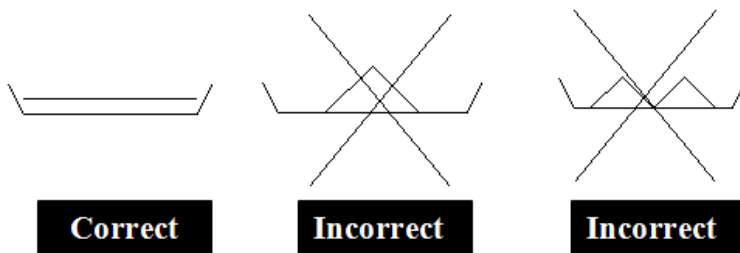

A sample that is thick or unevenly distributed will cause the top surface of the sample to be overly dried and possibly burned while the sample underneath the top surface remains wet. This may result in the sample being burned or the top surface hardening which will make the analysis more difficult as well as inaccurate.

A sample should always be placed in uniform layers measuring 2 to 5mm in thickness and weighing 5 to 15g, depending on the substance. When drying liquids, pastes, or substances that may melt or lose liquid during the drying process, the use of glass fiberfilters is recommended as filters ensure equal liquid distribution. When solid materials are being dried, a glass fiberfilter will prevent the sample from burning.



## Chapter 10: Performing Moisture Analysis

After configuring all of the necessary parameters and preparing the sample, you may begin your moisture analysis by following the steps below:

1. Open the Drying Chamber.
2. Using the Pan Handle, place the Disposable Pan on the Pan Support.

**Note:** Be sure the Pan Handle is not touching the Pan Shield.



3. Press the T key to Tare the Disposable Pan.
4. Place the sample on the Disposable Pan. After the Tare has been performed, the Disposable Pan can be removed from the Pan Support by using the Pan Handle to evenly distribute the sample.

**Note:** Make sure the sample is evenly distributed on the Disposable Pan.



5. Close the Drying Chamber.
6. Press the START key. The unit will indicate on the display that Heating is in progress. The moisture content of the sample will be displayed as a percentage (%). During the analysis, in addition to the result, the display will indicate the Drying Chamber Temperature, the present weight of the sample, the elapsed time, and the initial weight of the sample.

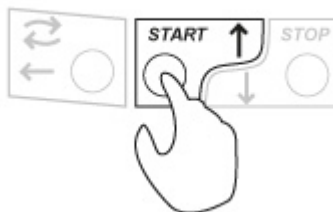

**Important Caution Note:** Do not touch the top surfaces of the Moisture Analyzer's Drying Chamber or any internal parts either during or soon after use. As the parts and surfaces will be very HOT, allow adequate time for the unit to cool. Be sure to read and follow all Caution Procedures listed in Chapter 1.

7. When the analysis is finished, "END" will be displayed in the lower right corner of the LCD. The Final result will remain displayed. To clear the result and prepare the unit for the next analysis, press the key STOP.

**Important Note:** Always use the forceps supplied with the unit when handling a used Disposable Pan.

## Chapter 11: Determining Drying Parameters for Unknown Samples

Optimal drying parameters for a sample can be easily obtained by performing trial-and-error analysis. The objective is to establish an ideal Drying Temperature for the sample, as well as an optimal Drying Time, and Sample Size.

**Drying Temperature** - An ideal Drying Temperature is such that will allow the analyzers to completely dry the sample in a reasonable amount of time (with unnecessarily delaying the analysis), but won't burn the sample. Burring or introduction of combustion will always result if an inaccurate result. Even discoloration can be a sign of combustion.

**Drying Time** – total drying time must be long enough to completely dry the sample. If drying time is too short, moisture will remain in the sample after the analysis is terminated therefore resulting in an incomplete result.

**Sample Size** – the size of sample must be an adequate statistical representation of the substance or matter which is analyzed. A sample should always be placed in uniform layers measuring 2 to 5mm in thickness and weighing 5 to 15g, depending on the substance. Large samples will require a longer drying time.

To perform trial-and-error analysis it is recommended to use the analyzer's graph plotting feature (Drying Chart). The graph will assist in determining optimal drying time.

### 11.1. Activating the Drying Chart

1. Press the Menu key and use the navigation keys to select option 3 (Drying Options).

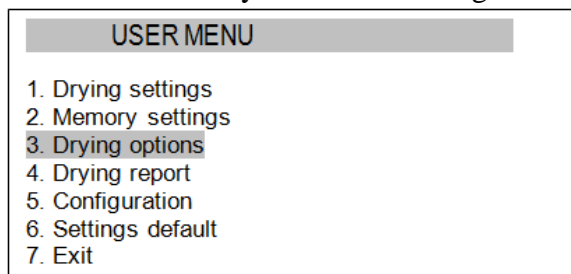

2. Use the navigation keys to select option 2 (Drying Chart)

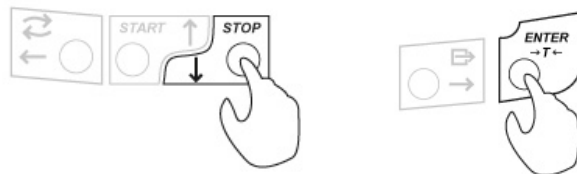
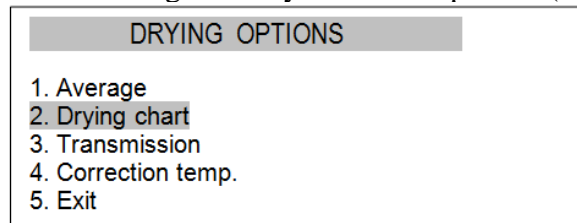

3. Enable the Drying Chart by switching Status from OFF to ON.

## 11.2. Setting trial parameters and performing trial-and-error analysis

1. Press the MENU key, then use the arrow keys to select “Drying Settings” and press ENTER
2. Use the arrow keys to select parameters and input trial values based on the following recommendations.

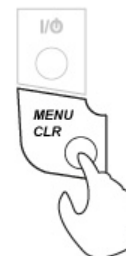

<b>Drying Temperature:</b>	<i>Organic substances:</i>	80 - 120 °C
	<i>Inorganic substances:</i>	140 - 160 °C
<b>Mode:</b>		Time Mode
<b>Calculation:</b>		$m_0 - m / m_0 * 100\%$
<b>Samples quantity:</b>		0
<b>Sampling Interval:</b>		1sec
<b>Drying Time:</b>		Estimate based on physical properties of the sample i.e. 20 to 30min for substances high in moisture.

3. Perform a trial analysis with the above recommended settings as well the Drying Chart feature enabled.

**Warning:** *Never leave the analyzer unattended while performing trial analysis.*

## 11.3. Interpreting the Trial Analysis, making adjustments, and finalizing the settings

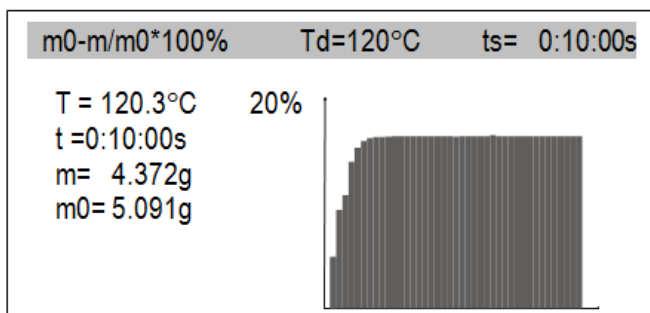

Drying Time can be derived by observing the Drying Chart on the analyzer’s display while the trial analysis is in progress. The sample is dried when the slope of the drying chart flattens. The actual drying time should be defined with a reserve, taking into consideration differences in the weight of successive samples.

Drying temperature can be derived by carefully observing the sample inside of the drying chamber while the trial analysis is in progress. Through the chamber peek glass observe the sample to make sure it is not burning or discoloring. If discoloration occurs or if the sample begins to produce smoke terminate the analysis by pressing STOP. Signs of combustion indicate that the current temperature is **too high**. Lower the temperature and perform the analysis again using a fresh sample.

If it is obvious that drying is taking too long and moisture is not evaporating quickly enough, terminate the drying, increase the temperature, and perform analysis again using a fresh sample.

## Chapter 12: Loading Saved Profiles and Parameters

To load saved parameters that have been stored in the memory, follow the steps below:

1. Press the Menu key and use the navigation keys to select option 2 (Memory Settings)

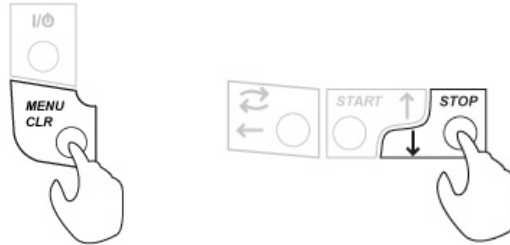
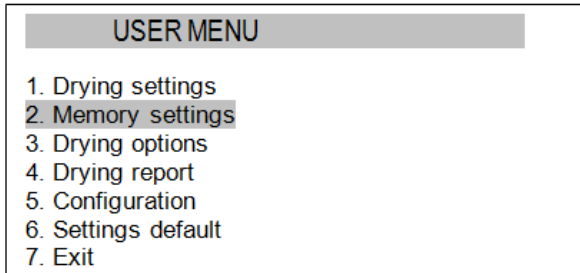

2. Use the navigation keys to scroll and select a desired memory location set of stored parameters.

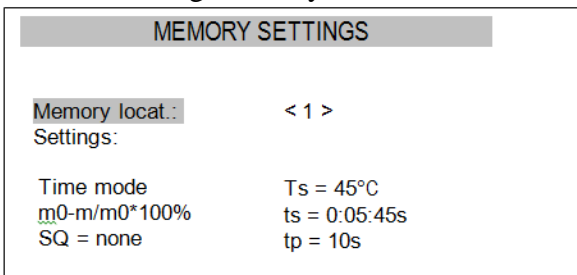

3. Once the set has been selected, press the ENTER key.
4. Stored parameters will be uploaded into the Analyzer's Configuration Menu.

## Chapter 13: Temperature Correction and Adjustment

The analyzer's temperature sensor can be recalibrated and adjusted to measure temperature based on readings derived from an external temperature probe or thermometer. Temperature calibration and adjustment should be performed only if the sample must be dried under strictly controlled temperature conditions, when temperature accuracy is of an essence in order to perform accurate drying. The external thermometer or temperature probe should be manufactured to highest standards and accuracy with a tractable certificate of calibration.

Two temperature readings (T1 and T2) must be taken to record the analyzer's temperature (Device temp.) and its equivalent values measured by external thermometer (Contr. temp.). T1 and T2 values should be based on the lowest and highest temperature settings that will be used in the analyzer. T1 and T2 correction parameters must conform to the following conditions:

T1 and T2 < 160 °C

T2 - T1 > 25 °C

T2 > T1

Maximum correction allowed: 20°C



TEMP. CORRECTION	
1. Device temp.	T1 =
Contr. temp.	T1=
2. Device temp.	T2 =
Contr. temp.	T2=
3. Status	<ON>
4. Exit	

### 13.1. Installing the external temperature probe

Insert the external temperature probe (1) through the opening located in the analyzers venting grill. The probe should be lowered to the same height as the analyzer's temperature sensor (3). To adjust the height of the probe use an adjustment sleeve (2) that will keep the probe in position. To calibrate the analyzer's sensor in relation to temperature of a specific sample, lower the probe as low-as-possible but without touching the sample.

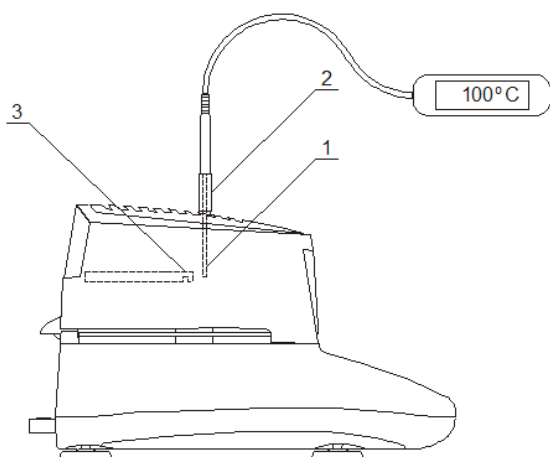

Correct:

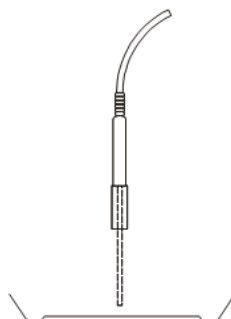

Incorrect:

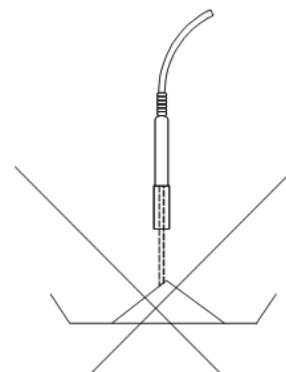

### 13.2. Obtaining temperature correction readings and enabling Temperature Correction

1. Configure “Drying Settings” to the lowest and highest temperatures that the analyzers will be used with i.e. 80°C (T1) and 150°C (T2). Use the analyzer in the Time mode with the Drying time set to 15 minutes.

	T1	T2
<b>Drying Temperature:</b>	80°C	150°C
<b>Mode:</b>	Time Mode	Time Mode
<b>Calculation:</b>	$m0-m/m0*100\%$	$m0-m/m0*100\%$
<b>Samples quantity:</b>	0	0
<b>Sampling Interval:</b>	10sec	10sec
<b>Drying Time:</b>	00:15:00s	00:15:00s

2. With the sample on the pan and probe installed, perform drying to obtain T1 readings for the analyzer (Device temp.) and the external temperature probe (Control temp.). To produce representative condition of the analysis it is recommended to have the sample on the when performing T1 and T2 analysis.
3. Once the temperature stabilizes, write down the temperature indicated by the analyzer as well as the temperature indicated by the external thermometer or temperature probe.
4. Reconfigure the drying parameters, allow the analyzer to cool down, and perform drying to obtain T2 readings.
5. Press the Menu key and use the navigation keys to select option 3 (Drying Options).

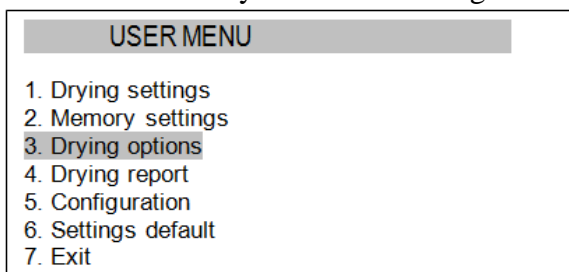

6. Use the navigation keys to select option 4 (Temp. Correction)

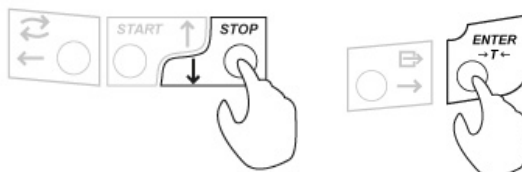
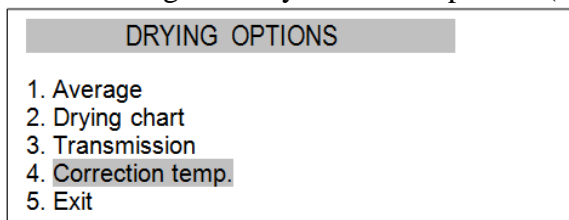

7. Input both T1 and T2 values and change the “Status” field to ON. Once enabled the analyzer will make the appropriate temperature corrections when drying.

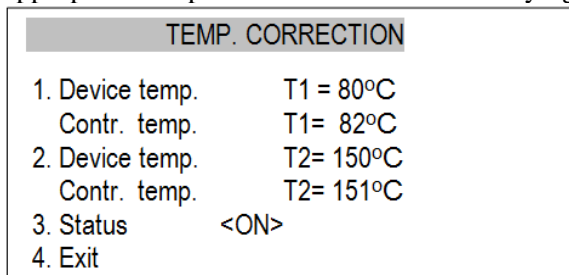

## Chapter 14: Drying Options

In addition to the “Drying Chart” and “Temperature Correction” the analyzer is equipped with “Averaging” and “Transmission” options.

**Averaging** – when enabled the analyzer will collect results of performed analysis and calculate an average. The average will be rolling until the user erases the collected data by selecting “Erasing” under [Drying Options / Averaging / Erasing].

**Transmission** – when enabled the analyzer transmits the result of each sample taken to a PC or a Printer (Via USB or RS232) during an analysis. The result can be sent in “g” (mass only), % (percent only) or both “g & %”. Transmission should be enabled in “g” (mass only) when collecting data for detailed statistical analysis, or when using the analyzer with the TORBAL ProMass software application.

<b>OFF</b>	Transmission is OFF sampling results are not be transmitted to a printer or a PC.
<b>g</b>	The analyzer sends the mass result of the sample taken.
<b>%</b>	The analyzer sends the percent (moisture result) of the sample taken.
<b>% + g</b>	The analyzer sends both the percent (moistures result) as well as mass result of the sample taken.

1. Press the Menu key and use the navigation keys to select option 3 (Drying Options).

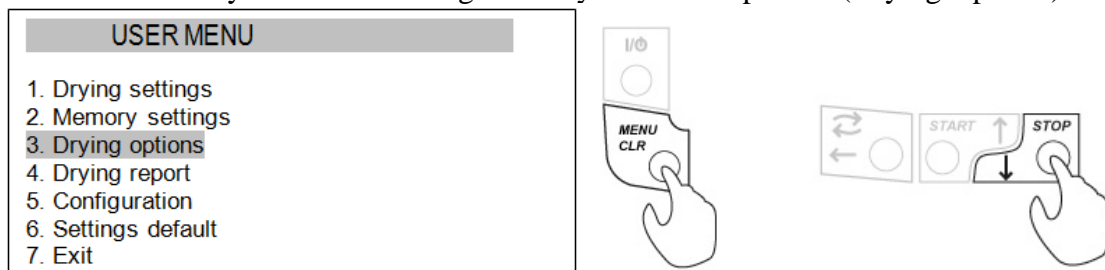

2. Use the navigation keys to select option 1 (Average) or 2(Transmission)

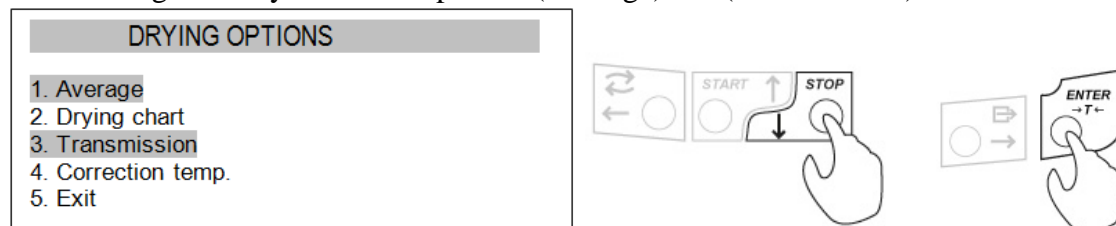

3. Enable the options by switching Status form OFF to ON.

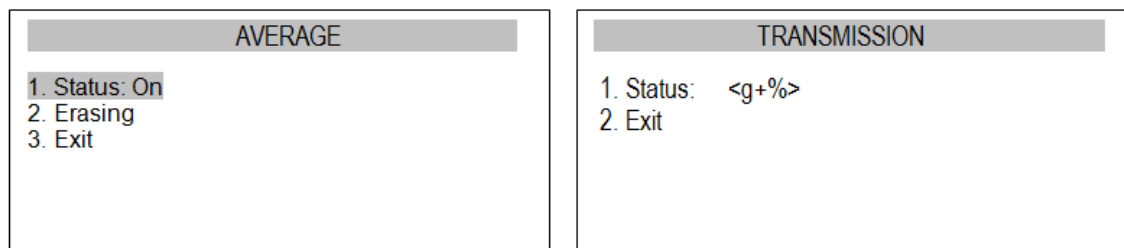



## Chapter 15: Report Printing Configuration and Data Transmission

The analyzer can be connected to printer or a PC. At the end of each transaction a detailed report of the drying results is produced. To print the reports press the Data Transfer key . The report includes details derived from you analysis as well as information that can be inserted by the operator i.e. product, operator name, or remarks.

To customize the printout or enter remarks follow the steps below:

1. Press the Menu key and use the navigation keys to select option 4 (Drying Report).

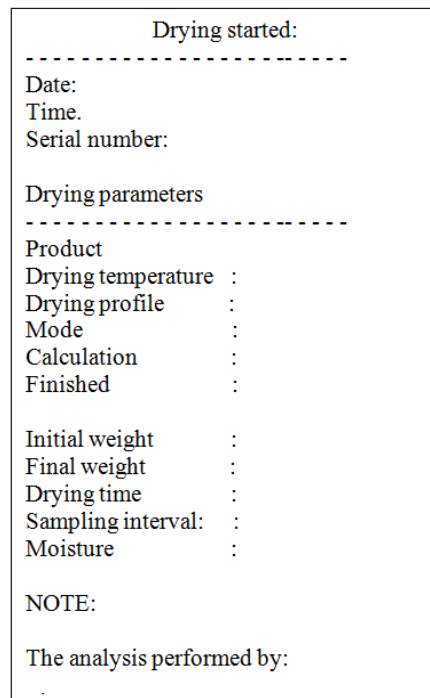
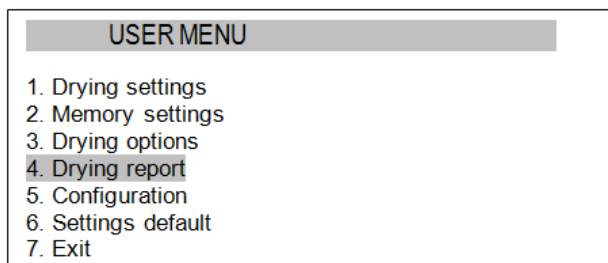

2. Use an external PS2 keyboard to type in the product and operator name as well as important analysis remarks. To customize the printout use the navigation keys to select option 4 (Print settings).

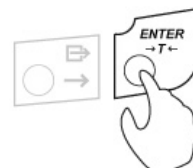
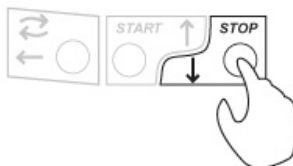
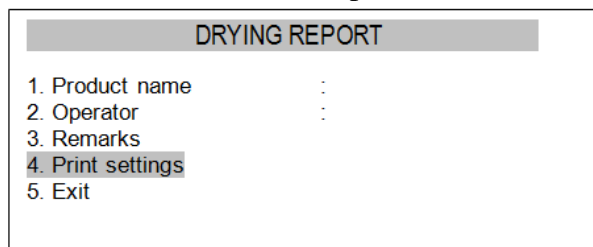

3. Use the navigation keys to select a desired parameter and press Enter to enable or disable printout parameter by placing or removing a checkmark.

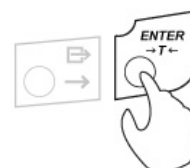
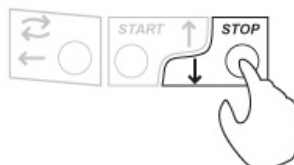
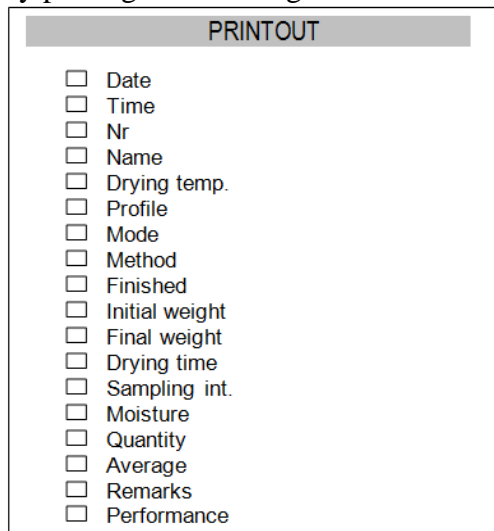

## Chapter 16: RS232 (Port 1) and USB (Port 2) Interface Ports

Before connecting the analyzer to a PC or printer configure the interface ports by following the steps below.

1. Press the Menu key and use the navigation keys to select option 5 (Configuration).

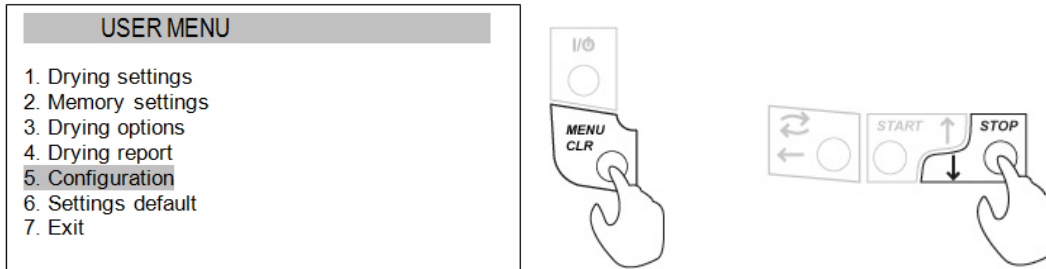

2. Use the navigation keys to select option 3 (Interface)

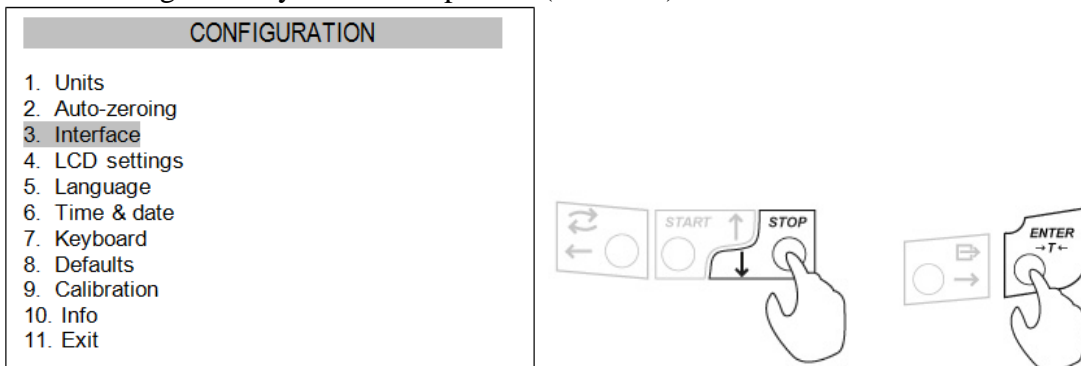

3. Select the desired port and configure the port parameters. Port 1 – RS232, Port 2 – USB

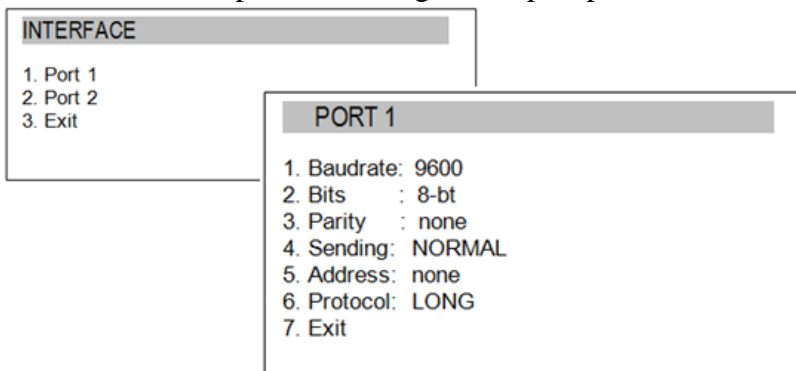

### Data Sending Modes:

NORMAL	Button plus Stability	Stable weighing result is transferred from the scale after pressing the  key,
NO STB	Button Only	Weighing result is transferred from the scale after pressing the  key (no stability required)
AUTOSTB	Automatic	Weighing result is automatically transferred from the scale after it stabilizes (no push key required)
CONTIN.	Continuously	Weighing results is continuously transferred from the scale at all times. (no push key and no stability required)

## Chapter 17: Configuration

The configuration options are used to setup general functions of the analyzer such as Unit of measure, LCD settings, Language and Time & Date.

1. Press the Menu key and use the navigation keys to select option 5 (Configuration).

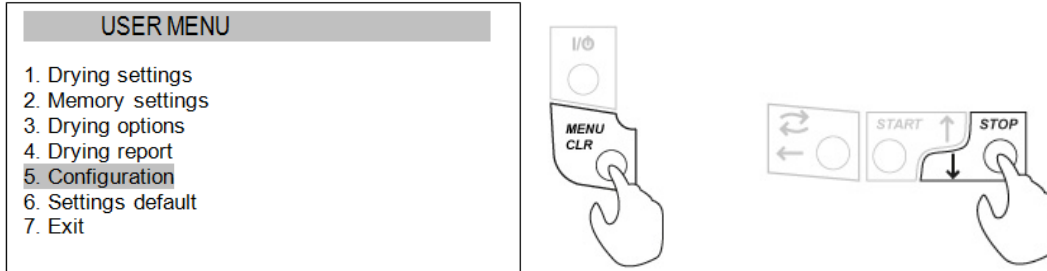

2. Use the navigation keys to select a desired option and press the ENTER key.

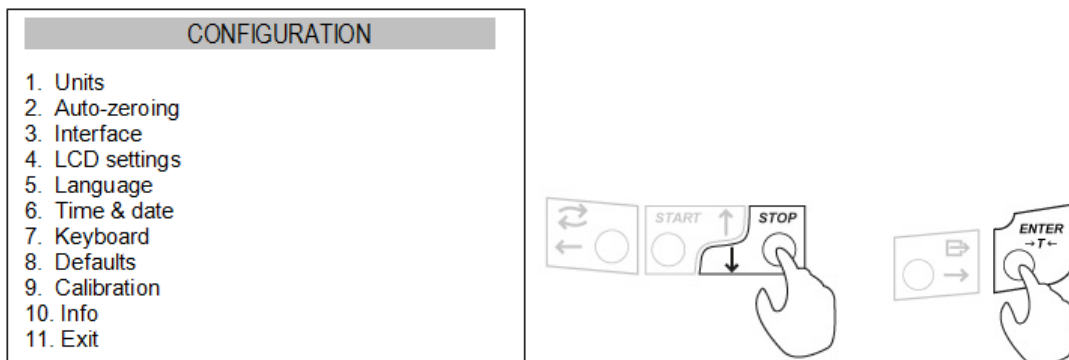

## Chapter 18: Restoring Factory Defaults

1. Press the Menu key and use the navigation keys to select option 6 (Settings Default).

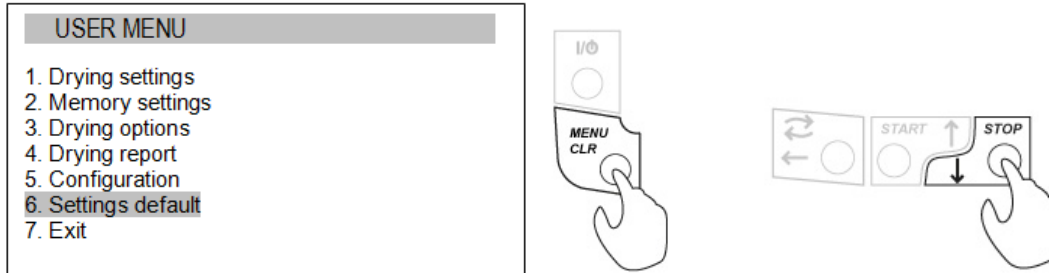

2. Select YES and press the ENTER key to confirm.

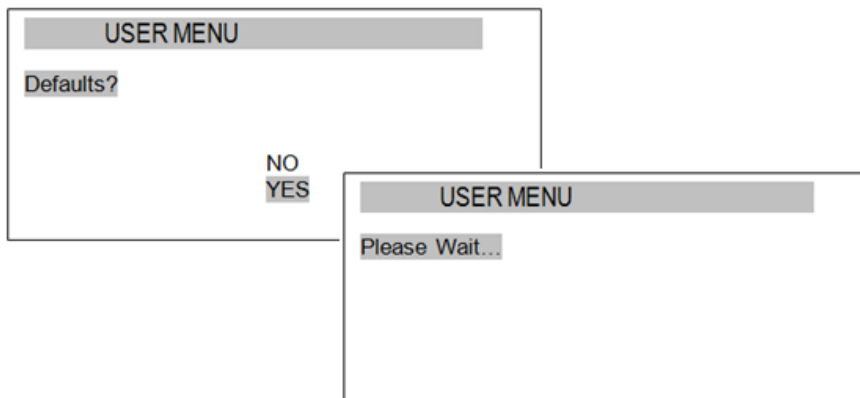

**Caution:** Restoring factory defaults erases the analyzer's database, therefore deleting all saved parameters and memory locations.



## Chapter 19: Testing the Analyzer with Sodium Tartrate Dihydrate

**Important:** Always wear protective goggles over your eyes and rubber gloves when handling Sodium Tartrate Dihydrate. Protect your mouth by wearing a dust mask.

### Warning:

If inhaled, Sodium Tartrate Dihydrate may cause mild irritation to the respiratory tract. If the chemical comes in contact with skin or eyes, it may also cause mild irritation. If swallowed, a large dose may cause gastrointestinal disturbances.

### First Aid:

- **If inhaled**, immediately move to an area with sufficient fresh air. Get medical attention for any breathing difficulty.
- **If ingested**, drink several glasses of water or milk. If a large amount was swallowed, get medical advice.
- **If skin contact occurs**, wash exposed area with soap and water. Get medical advice if irritation develops.
- **If eye contact occurs**, wash eyes thoroughly with water. Get medical advice if irritation develops.

Sodium Tartrate Dihydrate is a chemical compound that can be used as a standard to check the accuracy of the Moisture Analyzer. When the chemical is heated to 150°C, it undergoes a chemical change that releases moisture (theoretically 15.66%) so the chemical should lose 15.51% to 15.81% of its weight. The “ $m_0 - m / m_0 * 100\%$ ” formula will show the results directly. If the chemical has been stored at elevated temperatures or subjected to mechanical abuse, the results may vary. To test the analyzer perform the following steps:

8. Configure “Drying Settings” to the following parameters:

Analyzer Model:	ATS	BTS
Drying Temperature:	150°C	150°C
Mode:	Short Mode	Short Mode
Calculation:	$m_0 - m / m_0 * 100\%$	$m_0 - m / m_0 * 100\%$
Samples quantity:	4	4
Sampling Interval:	10sec	20sec
Drying Time:	00:20:00s	00:25:00s

9. Perform the analysis using 5g to 5.5g of Sodium Tartrate Dihydrate. Be sure to spread the sample evenly throughout the disposable pan.
10. Wait for the analysis to be terminated automatically by the analyzer (Short Mode). Confirm that the result is between 15.51% and 15.81%.

## Chapter 20: Replacing the Halogen Lamps and cleaning the chamber

### Cleaning the Analyzer

- Before cleaning the unit or replacing halogen bulbs, always unplug the power cord from the electrical outlet.
- Before performing any maintenance on the unit, make sure all parts and surfaces of the Analyzer have cooled.
- Use a soft, **lint-free**, slightly damp cloth to clean the Analyzer.
- Wipe the unit gently. Do not allow any liquid to enter into the Analyzer's weighing or drying mechanisms.
- Do not touch the temperature sensor (see parts description).
- Do not apply extensive pressure to the LCD display.
- Do not use chemicals especially benzene when cleaning the surface. Corrosive chemicals may damage the finish.
- Alcohol may be used only to clean the scale's stainless steel pan support or the pan handle.
- To prolong the life of the halogen bulbs, be sure the bulbs are clean and free from fingerprints. Even a small amount of oil from your fingers can cause the bulb to break when it is turned on.

### Replacing the Halogen Bulb

Replace the halogen bulbs when they are defective or when you sense that drying is taking more time than usual.

#### Warning:

- Before replacing the halogen bulb, avoid electrical shocks by unplugging the power cord from the electrical outlet.
- Make sure the rated voltage of the new halogen bulbs is correct for the voltage of the power supply,
- Handle the old bulb with care to avoid cracking. Broken glass may cause injury.
- Never touch a halogen bulb with your bare fingers.
- Always wear gloves when handling a new bulb. Even a small amount of oil from your fingers can cause the bulb to break (or shorten its life) when it is turned on.
- If a bulb is touched, before being used it may be cleaned with a lint-free cloth.
- When replacing the bulbs in the Analyzer, avoid touching the temperature sensor

To replace the halogen bulbs follow the steps below:

1. Open the drying chamber
2. Raise the protective glass plate upward until it is released by the bottom latches that hold the glass in place.
3. Gently remove the glass by tilting the lower edge of the glass in the outward direction, as shown in the illustration.

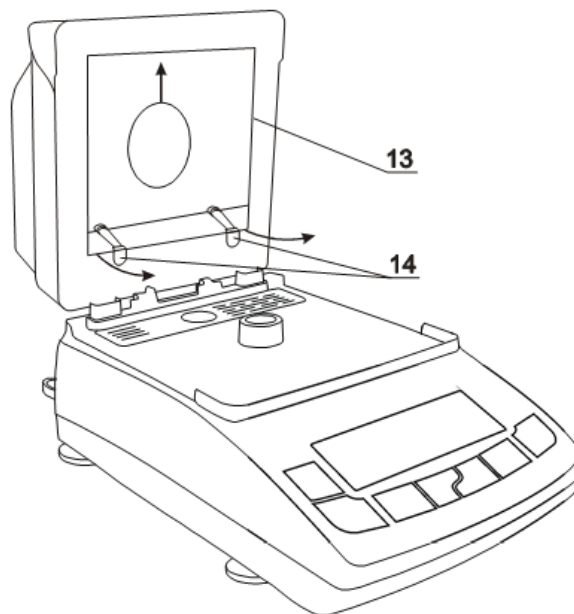

## Chapter 21: Calibration

When the Analyzer is initially installed, it must be calibrated to ensure accurate weighing results. Calibration should be performed periodically or whenever the unit is moved to a different location. Before calibrating the Analyzer, have the appropriate calibration weight available.

1. Press the Menu key and use the navigation keys to select option 5 (Configuration).

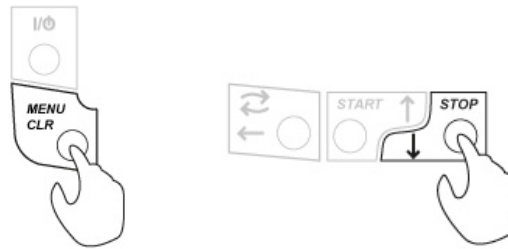
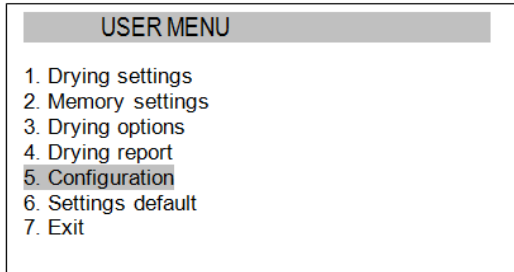

2. Use the navigation keys to select *CALIBRATION* and press the ENTER key

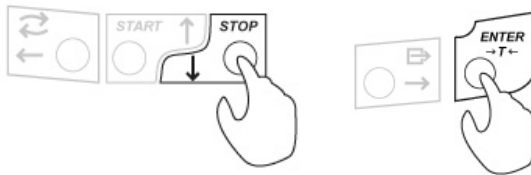
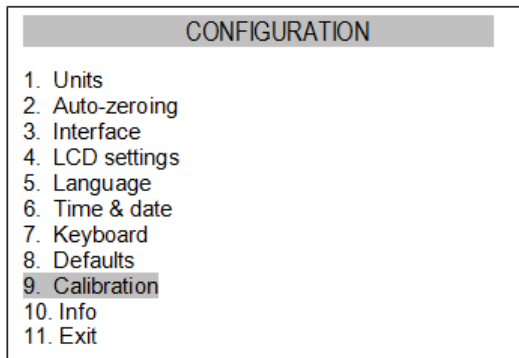

3. To change the calibration mass, use the navigation keys to select *LOAD* and press ENTER.
4. Use the navigation keys to select the allowed external loads for calibration. The load equal to full scale range is recommended. Be sure the weight used for the External Load is of sufficient accuracy for your purpose. Once the Calibration mass has been selected press the ENTER key to accept the External Load selection.

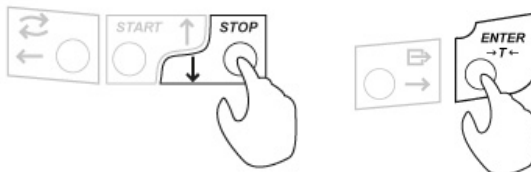
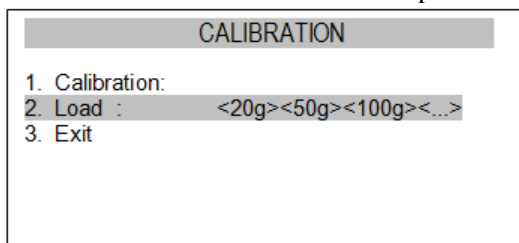

5. To begin Calibration, select option 1 (CALIBRATION) and press the ENTER key to start the calibration process.

6. Before calibration begins, the scale will perform an automatic tare.

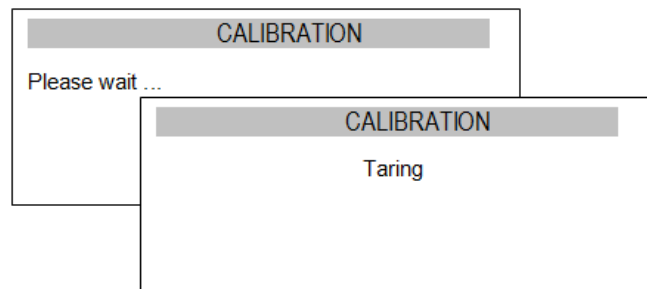



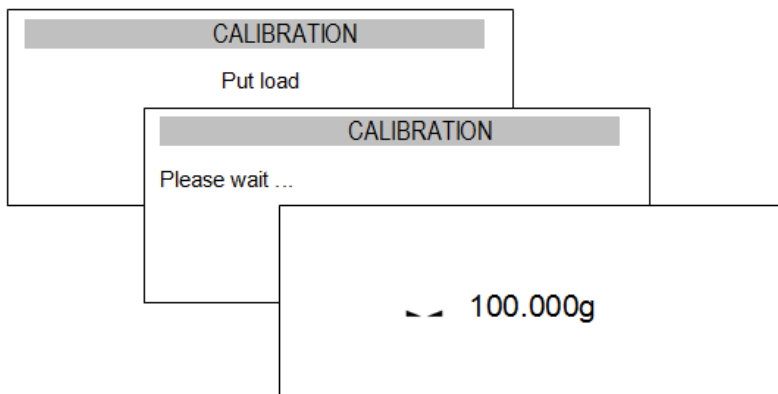

7. After the tare is complete, the screen requests that the External Load, to be placed on the pan.
8. Place the External Load on the pan.
9. When the calibration weight is placed on the pan, the scale will automatically begin the calibration process.
10. When calibration is complete, the calibration mass value will be displayed.





## Chapter 22: Weighing

1. To begin weighing, press the toggle key () to switch from a Moisture Analyzing Mode to a Weighing Mode or vice versa. The scale is ready to begin weighing as soon as the stabilization indicator () appears on the display.

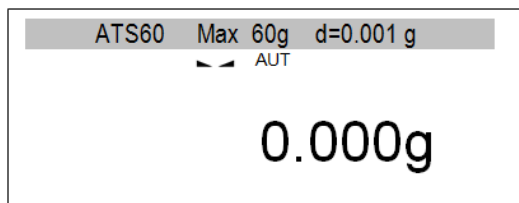

2. When weighing, always place the mass in the middle of the pan. The weighed result may be taken when the stabilization indicator appears on the display.

### 22.1. Taring

1. If a container is used for weighing, it may be tared. In taring the container, the scale subtracts the weight of the container from the gross weight to obtain the net weight.
2. To tare the weighing container, place it in the middle of the pan. The container's weight will be shown on the display.

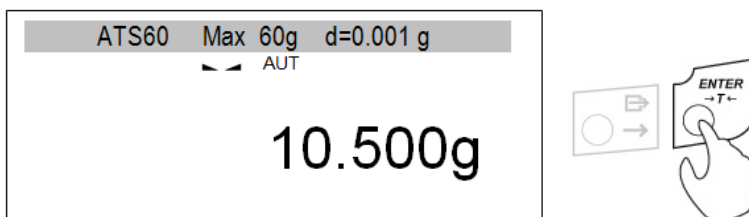

3. Once the stabilization indicator appears on the display, the container is ready to be tared. To tare the container, press the T button. The display will show a dotted line which indicates the scale has begun the taring process.

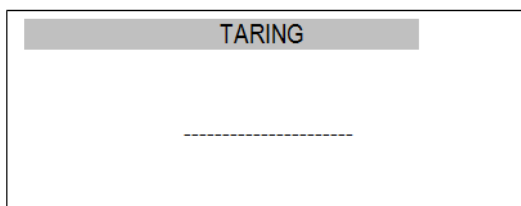

4. When finished taring, the balance will return to Weighing Mode.

**Note:** Do not touch or move the scale during the taring process.

## 22.2. Clearing a Tare

1. To clear the tare, remove the tared object along with the net weight from the pan. The scale will then display a negative tare result.

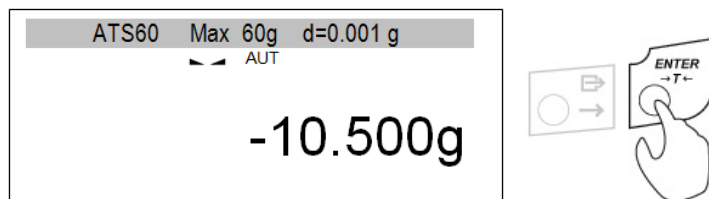

2. To clear the tare, press the T button.
3. The display will show dashed lines indicating the tare is clearing.

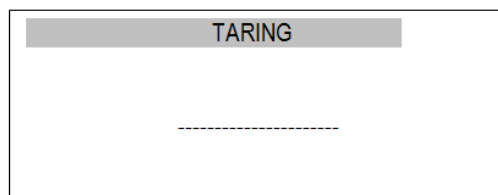

4. When finished clearing the tare, the scale will return to Weighing Mode.

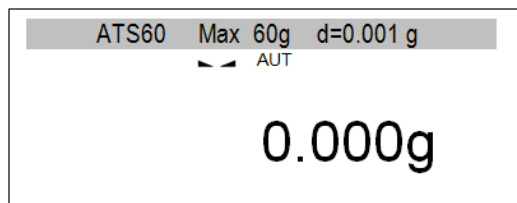

## Chapter 23: Common Errors and Troubleshooting

### Common Analysis problems:

Problem	Solution
Sample Burns	Reduce temperature Use glass fiberfilter on the top of the sample Reduce sample quantity and distribute it uniformly
Drying takes too long	Increase temperature Reduce sample mass
A sample is liquid or paste	Use glass fiberfilter
A sample does not consist of enough volatile matters	Enlarge a sample

### Troubleshooting:

Problem	Possible cause	Solution
Initial heating “Td” temperature exceeds 105°C,	The temperature sensor is damaged.	Contact the manufacture.
Initial heating “Td” temperature does not reach 105°C within 3 minutes, the halogens do not light up.	The heater is damaged.	Contact the manufacture.
„Tare range exceeded”	Tare key pressed during zero indication	Balance indications must be different than zero
„Zeroing range exceeded”	Allowed zeroing range was exceeded	Remove the load from the pan
„Weighing range exceeded”	Maximum weighing capacity (Max +9e) was exceeded	Reduce the load
„Measuring range exceeded (+)”	Upper limit of analog-digital transducer measuring range was exceeded	Remove the load from the pan
„Measuring range exceeded (-)”	Lower limit of analog-digital transducer measuring range was exceeded	Check pan for proper installation. Make sure all parts of the pan are installed/



## Chapter 24: Warranty

### PURCHASER'S 12-MONTH WARRANTY

Warranty is valid only if the attached warranty registration card is completed and returned within 30 days.

This product is a precision device made to exacting standards of scientific accuracy. It is guaranteed to have been adjusted and inspected for proper workmanship and performance and to be certified for its currently advertised specifications before shipment.

Fulcrum Products are warranted against defects in material and workmanship under normal use and service. This warranty is extended only to the first purchaser. This limited warranty will not apply if, upon inspection, it is found that the product was tampered with, misused, overloaded, abused, mishandled, placed in an improper environment, improperly installed or adjusted, used for a purpose other than that for which it was designed, or repaired by unauthorized personnel.

Fulcrum's liability under this warranty is limited to furnishing the labor and parts necessary to remedy the defect covered by this warranty and restore the product to normal operating condition. Purchasers may be charged a minimum repair fee for in-warranty products returned for repair if those products are determined to be problem-free.

To make a claim under this limited warranty, obtain an RMA number from Fulcrum and return the product (carefully packed in its original packaging and shipping prepaid) with the RMA number written on the return package.

## Chapter 24: Drying parameters for common materials and substances

No	Substance	Initial weight (g)	Temperature (°C)	Preparation	Analysing time (min)
1.	Acrylate seal	3		mix a sample	9
2.					
3.	Granulated sugar	3	90		3
4.	Icing sugar	5	130		20
5.	Butter	2	140	tear up a foil	4
6.	Margarine	2	160		4
7.	Ketchup	2	120		18
8.	Mustard	3	80		19
9.					
10.	Peanuts	3	100	grind into thick powder	6
11.	Nuts in shells	3	100	grind into thick powder	4
12.	Nuts	2	100	grind into thick powder	4
13.	Peanuts	3	100	grind into thick powder	4
14.					
15.					
16.	Cheese	2	160		13
17.	Cottage cheese	6	140	mix a sample	
18.	Cottage cheese (rural)	1	130	mix a sample	8
19.	Mozzarella cheese	2	160		11
20.	Melted cheese	3	160		5
21.					
22.	Dry beans	3-4	105	grind a sample	5
23.	Bean	5	150	grind a sample	10
24.	Pea	4	135	grind for 30 sec.	8
25.	Dry peas	5-7	110	grind a sample for 10 sec.	10
26.	Dry carrot	5.5-6	120	grind a sample	3
27.	Dry corn	5-7	110	grind a sample	10
28.	Dry potato pieces	3	130	divide a mass	6
29.	Lentil	4	135	grind a sample for 30 sec.	6
30.	Corn starch	2	160		5
31.	Oily seeds	3-4	90	grind a sample for 1 min	8
32.	Rice	4	105	grind a sample for 30 sec.	13
33.	Rye	5	150	grind a sample	12
34.	Beetroot	5	150	grind a sample	9
35.	Sesame seeds	3	130		8
36.	Soya-bean flour	5	95		5
37.	Sunflower seeds	4	100	grind a sample for 2 min	4
38.	Cotton seeds	3-4	110	grind a sample for 1 min.	6
39.	Wheat flour	6	130		
40.	Wheat flakes	4	150	grind a sample	7
41.	Water to flour	2-3	90		10
42.	Plastic rag	1	160		4
43.	Natural rag	1	160		14
44.					
45.	Feeding stuff	3-4	150		6
46.	Pig feeding stuff	4-5	160	mix a sample	21
47.					
48.	Coffee	2	150		8
49.	Instant coffee	5		mix a sample	10
50.	Coffee seeds	4	120	grind a sample for 1 min.	8
51.	Cocoa	3	105		4
52.	Cocoa seeds	4-5	130	grind a sample for powder	8
53.	Chocolate	2	103		10
54.	Grinded chocolate	2-3	90		10
55.	Almonds with caramel	4	80	grind into thick powder	5
56.	Normal almonds	3	100	grind into thick powder	5
57.	Almonds	3	100	grind into thick powder	5
58.					
59.	Tobacco	2	100	tear up into pieces	16
60.					
61.	Multivitamin bars	3	115	grind into thick powder	3
62.	Mint pastilles	3	90	grind into thick powder	3



Instruction Manual – ATS / BTS Moisture Analyzers

63.	Sticks	3-4	75	grind into powder	9
64.					
65.	Skimmed milk	5	110	mix a sample	
66.	Skimmed milk powder	5	90		6
67.	Fat milk powder	5	100		6
68.	Whole milk	5	110	mix a sample	
69.					
70.					
71.	Concentrated orange juice	2-3	115	mix a sample	13
72.					
73.	Dry chicken excrements	4	140		8
74.					
75.	Soap	3	120	pinch some pieces	6
76.	Starch derivatives	3	150		12
77.	Starch glue	2	100	mix a sample	9
78.	Detergent	2	160		12
79.					
80.	Textile	1	85	separate fibres	3.6
81.	Materials for bricks	7	160	distribute a sample	20
82.	Silicon sand	10-14	160		1.9
83.	Dolomite	10-12	160		6
84.	Loess soil	3	160	cut into small pieces	15
85.	Ceramics clay	3	160	cut into thin slices	9
86.	Limestone	12-14	160		5
87.	Glass powder	8-10	160		5
88.	River water	4	160	mix a sample	20
89.					
90.	Active coal	10	80		10
91.	Coal powder	4	160		4
92.	Natural chalk	8	160		2
93.	Granulated acryl	10-15	80		12
94.	Acryl ester	2		mix a sample	19
95.					
96.	Cellulose matter	2	130	tear up into pieces	5
97.	Photo paper	2	150	tear up in 1 cm <sup>2</sup> pieces	6
98.	Dialyse membrane	1	80	cut into thin slices	2
99.					
100.	Drawing ink	2	120		10
101.	Toner	3-4	40		
102.	Powder paint	2	120		4
103.					
104.	Dialyse membrane	0.5-0.7	80	cut into thin slices	2
105.	Leak stopper	3	160		7
106.	Glue dissolvent	2	140		10
107.					
108.	Latex	1-2	160		5
109.	Natural latex	2	160	mix a sample	6
110.	Balsam	1	130		8
111.	Soda bihydrate	2	160		12
112.	Ultramid	10	60		10
113.	Silicon gel	10	115		5
114.	Macrolon	10-12	80		15
115.	Plexiglas 6N	10	70		10
116.	Polypropylene	13	130		9
117.	Polypropylene	3	120		2
118.	Polystyrene solution	2	120		9
119.	Polystyrene	10	80		10
120.					
121.	Dissolvent	2	155	mix a sample	8
122.	Resin dissolvent	2	160	mix a sample	6
123.					

# Fulcrum Inc.

---



**Fulcrum Inc.**

100 Delawanna Ave. Suite 502

Clifton, NJ 07014

Tel. (973)473-6900

Fax. (973)777-8302

[www.fulcruminc.net](http://www.fulcruminc.net)

[www.torbalscales.com](http://www.torbalscales.com)