

Table of Contents

1. Cautionary notes and precautions.....	2
1.1 Important handling cautions and warnings.....	3
2. Specifications.....	7
3. Keys, Display Indicators and Abbreviations.....	8
4. Parts Descriptions.....	9
5. Unpacking Balance and Getting Started.....	10
6. Basic Principles of weighing.....	13
7. Functions, Descriptions and Definitions.....	14
8. Weighing.....	15
8.1. Weighing.....	15
8.2. Taring.....	15
8.3. Extending the Resolution.....	17
8.4. Zeroing the Scale.....	17
9. Auto-Zero.....	18
10. Parts Counting.....	19
10.1. Using the Default Sample Size Setting.....	19
10.2. Using a custom sample size.....	21
10.3. Counting based on a known Individual Piece Weight.....	23
11. Units of Measure.....	25
12. Percent Weighing.....	26
13. Recipe Weighing.....	28
14. Calibration.....	31
14.1. Quick Calibration.....	31
14.2. Stepped Calibration.....	33
Calibrating with a calibration mass value which is not equal to the scale's capacity.....	
15. Port 1 - RS232 Communication Port Configuration.....	35
15.1. Data Transmission and Exchange Protocol.....	35
15.2. Baud Rate.....	37
15.3. Bites.....	37
15.4. Parity.....	38
16. Receipt Printout.....	39
16.1. Enabling and Disabling Receipt Field.....	40
16.2. Assigning Operator and Product ID numbers.....	40
17. Dynamic and Animal Weighing LOC.....	41
18. Storing Tare Values.....	42
18.1. Storing a Tare Value Manually.....	42
18.2. Storing a Tare Value Automatically.....	43
18.3. Recalling a previously stored tare value.....	44
19. Min Max Weighing.....	45
20. Newton – Force Measurement.....	46
21. Filtering.....	47
22. Date and Time.....	48
22.1. Enabling and Disabling Date and Time stamping.....	48
22.2. Setting the current date and time.....	48
22.3. Enabling PIN access to the Date Configuration Function.....	50
23. Threshold Check Weighing and Opto-Isolator.....	51
23.1. Enabling Check Weighing and Setting Threshold Limits.....	51
23.2. Setting the Output Mode for the Opto-Isolator.....	53
23.3. Opto-Isolator Output.....	54
24. Totalizing.....	55
24.1. Performing Totalizing.....	55
25. Changing to Grams (g) or Pounds (lbs).....	57
26. Menu Customization.....	58
27. Restoring Default Settings.....	58
28. Common Errors and Troubleshooting.....	59
29. Maintenance.....	59
30. Limited Warranty.....	60

Chapter 1: Cautionary Notes

Remember choose a proper location for you scale and to always handle the unit with care.

The correct location and proper environment makes an important contribution to the accuracy of the weighing results of TORBAL industrial scales.

The optimum location for your scale:

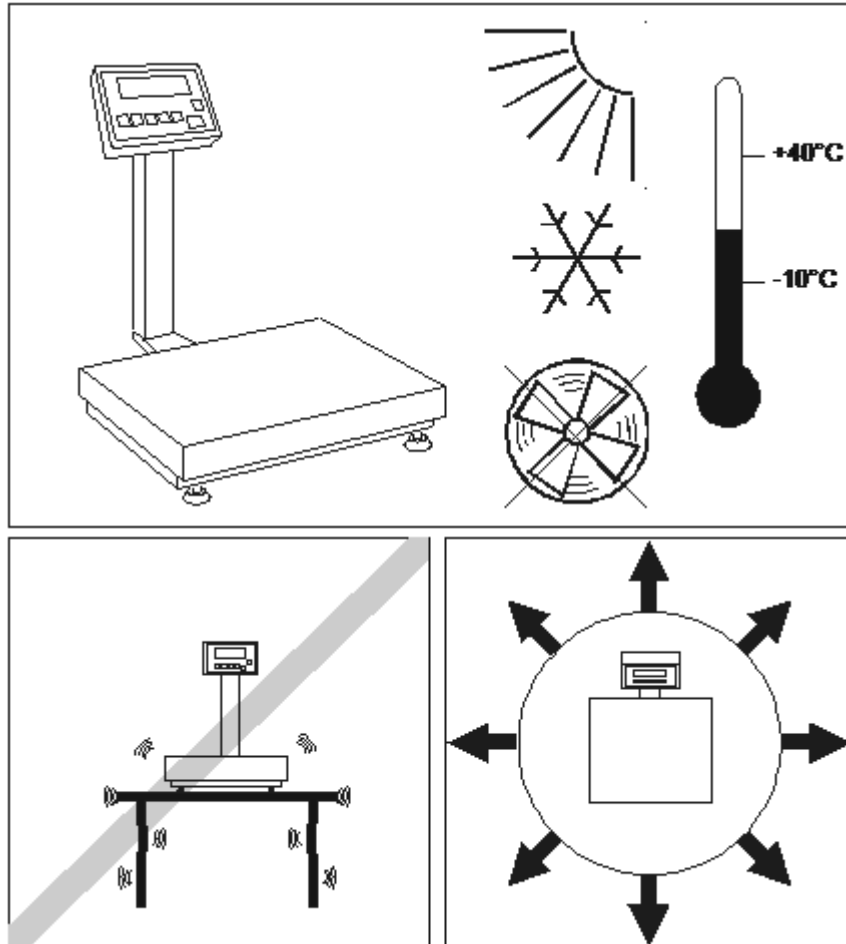



- Stable, vibration-free base as horizontal as possible
- Away from direct sunlight
- Not exposed to high temperature variations
- Away from direct drafts
- The best location is a stable surface away from direct drafts, doors, windows, radiators and air conditioner vents.

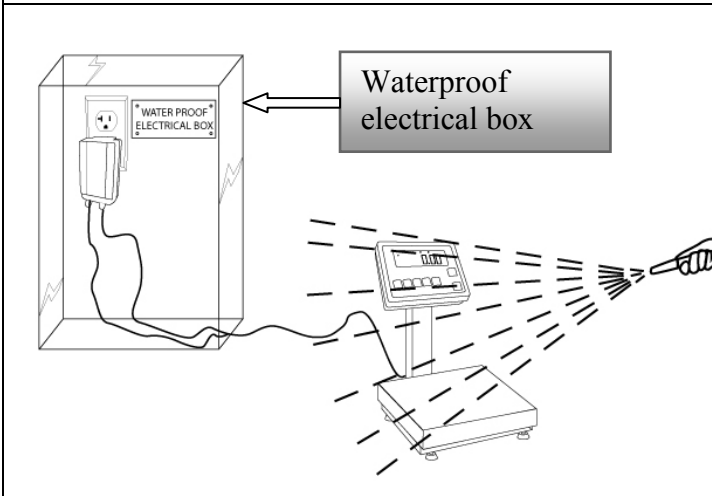
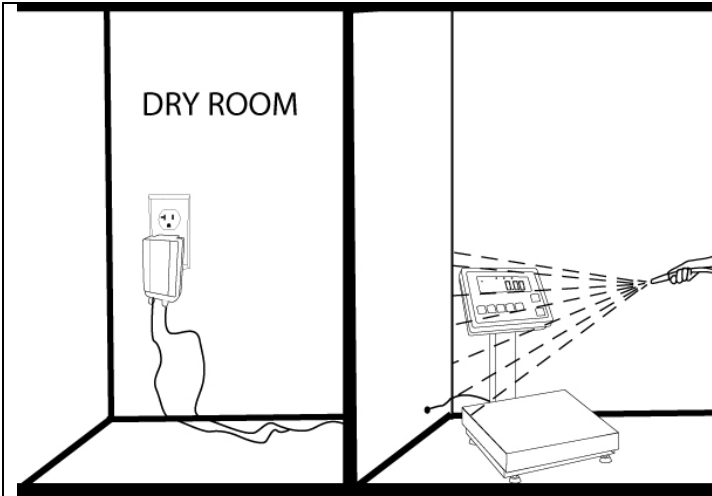

	<p>NEVER submerge the scale. Ingress Protection Rating - Load cell: IP68 , Indicator:IP65</p>
	<p>Never spray water on the scale's power supply. The AC Adapter is NOT waterproof and may not be exposed to the washdown process.</p>
	<p>Never attempt to cover the adapter with a plastic bag or covering. This will not protect the adapter. Covering the adapter is dangerous, may cause damage and an electrical shock.</p>





The power cord should be “fished” into a dry room or a waterproof electrical box. Consult a licensed electrician regarding an appropriate location and connection methods.

<p>CAUTION:</p> 	<ul style="list-style-type: none"> • The scale is designed for indoor use only. • Do not operate the scale in hazardous areas or conditions. • Be sure to set the scale on a firm, stable, horizontal surface. • Never stand on or lean on this product. Equipment may fall or collapse, causing breakage and possible injury. • Before moving the product, unplug it and unplug all cables connected to it. • When storing, transporting or returning the scale for service, always use the original packaging.
<p>WARNING:</p> 	<ul style="list-style-type: none"> • Never attempt to repair, disassemble or modify the scale yourself. Tampering with the scale may result in injury and cause more damage to the equipment. • Be sure to use the specified power source. • Do not allow foreign matter to fall into the scale.

1.1. Important handling Cautions and Warnings



Always handle your scale with care. Damage caused by improper handling is not covered under the scale’s warranty.

	<p>Never drop or throw any articles onto the scale’s pan or onto any other parts of the unit!</p>
	<p>DO NOT let the scale fall or drop from its tabletop surface!</p>

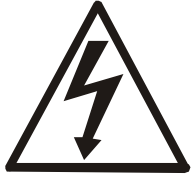

Follow all safety guidelines in order to avoid electrical shock, or damage to connected peripheral devices.

- All necessary repairs or internal adjustments should be made by authorized personnel only.
- To avoid the risk of fire use an outlet of the proper type that provides the specified voltage. The required voltage for the power supply is 115vAC @ 60Hz and requires a minimum of 1.2 amperes of current.
- Do not use the scale when the cover is open.
- Do not use the scale in explosive atmospheres.
- If the scale does not operate properly, unplug the power supply and do not use it until checked by authorized personnel.

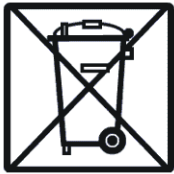

Disposal of electronic equipment in waste containers is forbidden by law.

- Please dispose of electronic equipment in appropriate recycling centers or by returning to the original point of purchase.

Chapter 2: Specifications

Table 1. Hermetic (Wash down) Series

	MODEL NUMBER										
Specification	3H	6H	15H	15 WH	30H	60H	63H	150H	151H	300H	301H
Capacity Kg/lb	3/6	6/15	15/30		30/60	60/ 120		150/ 300		300/ 600	
Readability (d) g/lb	1/ 0.002	2/ 0.005	5/ 0.01		10/ 0.02	20/ 0.05		50/ 0.1		100/ 0.2	
Increased Resolution (5sec) g/lb	0.1	0.2	0.5		1/ 0.002	2/ 0.005		5/ 0.01		10/ 0.02	
Stabilization time	<3 SEC				<4 SEC						
Tare Range in Kg	-3	-6	-15		-30	-60		--150		-300	
Platform Dimensions mm	250 X 260X130			400X 400X 130	500X400 X130		600X500 X150		800X 800X 160	600X500 X150	800X800 X160
Overall Dimensions mm (in)	250X260X400 (10X10X15.7)			402x 582x 590	402x672x690 (16X26X29)		602x667x690 (23.7x26.2x 27.2)		803x 982x 690	602x667x 690	803x982x 690
Scale Weight Kg / lb	7/15.4			13/ 28.6	23/50.6		35/77		50/ 110	35/77	60/ 132
Operating Temp	-10C TO +40C										
Power Supply	12VDC@500ma				12VDC@850ma						
RS-232 Port	BIDIRECTIONAL										
USB	B tper										
Class	III										
IP Rating	Load cell: IP68 , Indicator:IP65										
Warranty	ONE YEAR										

Chapter 3: Keys, Display Indicators and Abbreviations

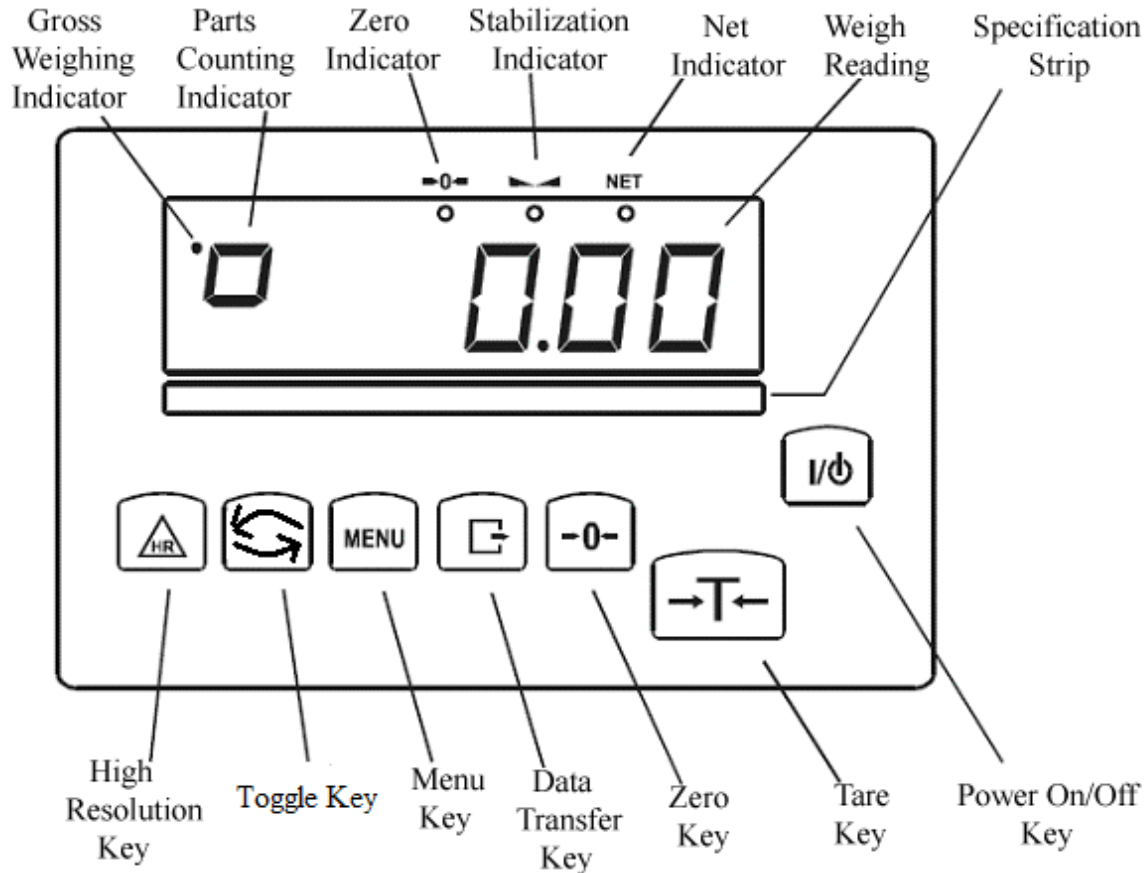

Key	Primary Function
I/O	Power On and Power Off
→T←	Tare – used to tare the weighing pan
→0←	Zero – used to zero the scale (Legal for Trade models only)
MENU	Menu – used to access the main menu
↗	Data Transfer – used to print data or transfer data to a PC via the RS232 communication port
↻	Toggle – used to toggle between various parameters in several different functions
HR	High Resolution – temporarily (5 sec) increases the display resolution
Display Indicator	Description
▬▬▬	Stability Indicator - The weighing result has stabilized and an accurate reading may be taken.
→0←	Zero - The scale is maintaining a “center of zero” condition. (Legal for Trade models only)
AUT	AZSM (Automatic Zero Setting Mechanism) is enabled. Always enabled in Legal for Trade models.
NET	Net Weight – indicates that the container weight has been removed by tare

Chapter 4: Parts Description

Pictures must be changed

BA Models:



Front View



Side View



Indicator



Column

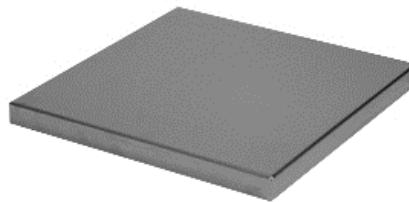

Pan



AC Adapter



RS232, USB, and power Ports



Level Indicator



Power Cord

Chapter 5: Unpacking the Balance and Getting Started

1. Carefully remove the scale, pan, and all of its components out of the packaging and place them on a stable surface where the scale will not be affected by any mechanical vibrations or high air movements.
2. After removing all components from the packaging refer to the assembly instructions which have been provided with the scale, and carefully assemble the unit.
3. After assembling the scale lift the platform pan and then remove straps which are used to secure the frame during shipping.

Important: When transporting the scale these straps must be replaced prior to shipping.

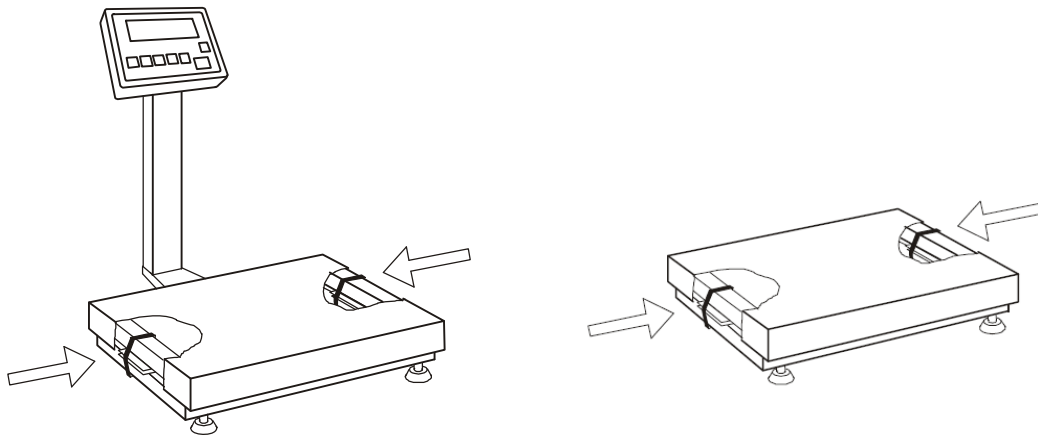

4. Use the rotational feet to level the scale. An air bubble level is built into the platform for this purpose. Adjust the feet until the bubble is center in the level indicator.



Correct



Incorrect

- The AC Adapter is not waterproof! A long power cord is provided to allow the Adapter to be plugged into a receptacle that is protected from the washdown process. The power cord should be “fished” into a dry room or a waterproof electrical box. Consult a licensed electrician regarding an appropriate location and connection methods.

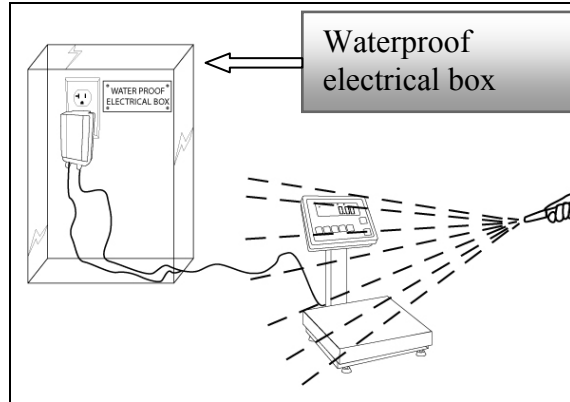
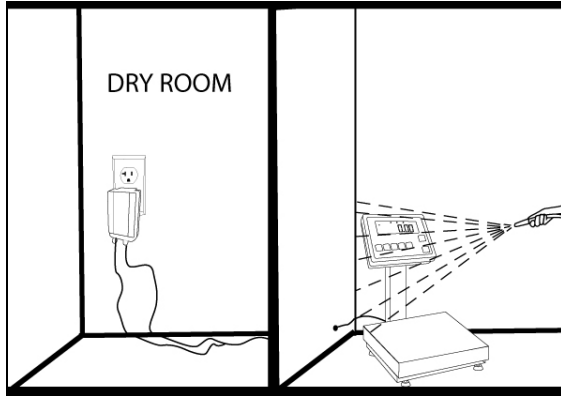

- Connect the power cord supplied with the scale to the power port located in the rear of the scale. (Do **not** plug the ac adapter into the power receptacle at this time)
- Firmly secure the power cord on the port.
- Use a screwdriver to connect the power cord spade lugs to the AC adapter terminals.

Do NOT plug the AC adapter into the power receptacle until the power cable is connected to the scale and the power terminals have been connected to the adapter.

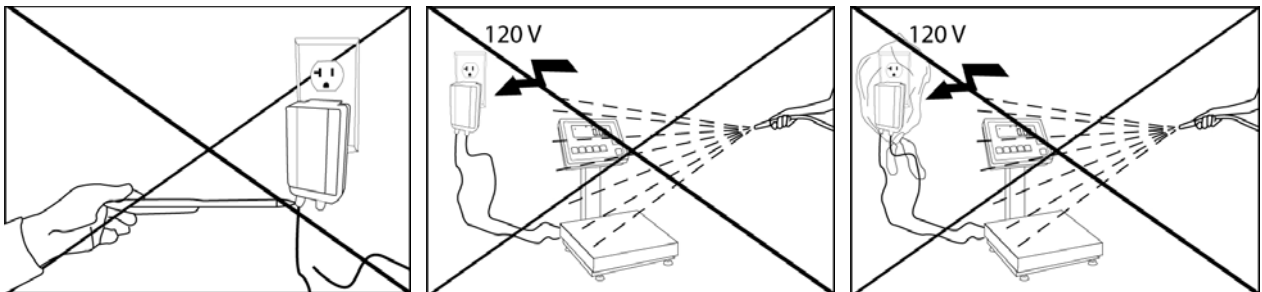
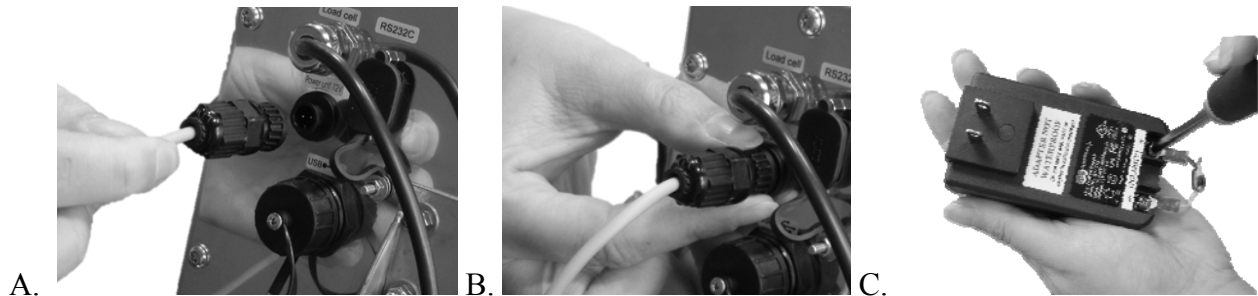

Never connect the spade lugs with adapter plug into the wall outlet. Never spray water on the adapter. Do not cover the adapter with plastic bag or any type of covering (it will not protect the adapter from moisture)

6. Make sure the protective waterproof covers are in place on any unused communications connectors.
7. When the AC adapter is plugged into the wall outlet, the scale will turn “ON” automatically, initialize itself, and enter weighing mode.

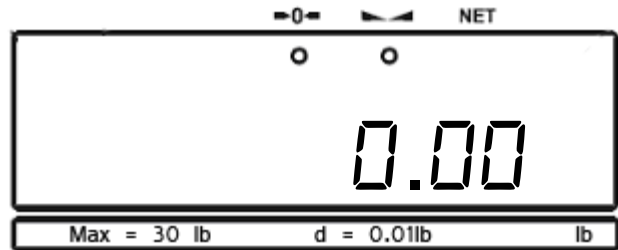
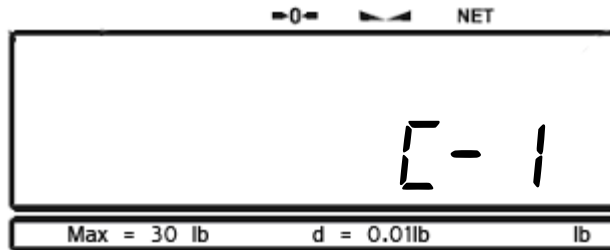

8. To turn the scale off press the Power “OFF” button (I/⏻).

Chapter 6: Basic Principles of Weighing

1. The scale should be properly zeroed before weighing. Proper zeroing is indicated by the Zero Indicator ($\rightarrow 0 \leftarrow$) on the display. If the display signals an out of zero condition (----), press the ($\rightarrow 0 \leftarrow$) key to Zero an empty pan.
2. Weighing allows taring over the entire weight range. This is accomplished by pressing the Tare key, ($\rightarrow T \leftarrow$). Care should be exercised when tare is in use to be sure that the scale's maximum capacity is not overloaded.
3. An accurate weighing result should not be taken until the stability indicator ($\blacktriangle \blacktriangleleft$), indicates that the result is stable.
4. For best results place the unknown weight in the center of the pan.
5. Use the "Active" function to customize the scale's main menu and disable functions that are not used. This makes using the main menu fast and easy.





Never overload the scale in excess of 20% of the scale's rated maximum capacity.

Chapter 7: Functions, Descriptions and Definitions

- **Parts Counting** is used to count parts based on their established average piece weight.
- **Percent weighing** is used to establish the relative weight of an unknown, compared to that of a stored reference weight and expressed as a percent.
- **Recipe Making** is used for weighing and summing individual ingredients such as powders or liquids during recipe making or mixing compounds.
- **Check weighing** is used to check whether a weight of an object falls within specified threshold limits.
- **Animal and dynamic weighing** is used to weigh animals or objects which are in motion while on the pan.
- **Tare Storing** is used to store the values of various containers used for weighing.
- **Filtering** is used to minimize or eliminate the effects of vibrations on the weighing surface.
- **Min / Max Indication** is used in conjunction with Check Weighing to control external indication or sorting equipment.
- **Totalizing** is used for summation of sequential weighing results of items or articles.

Chapter 8: Weighing

8.1. Weighing

1. To begin weighing, press the power button () to turn the scale ON. The scale will go through its initialization procedure and automatically enter “Weighing Mode”. The scale is ready to begin weighing as soon as the stabilization () and zero ($\rightarrow 0 \leftarrow$) indicators appears on the display.

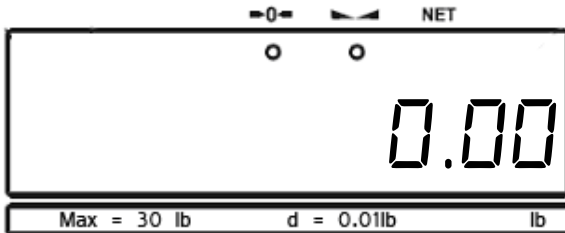

2. When weighing, always place the mass in the middle of the pan. The weighed result may be taken when the stabilization indicator appears on the display.

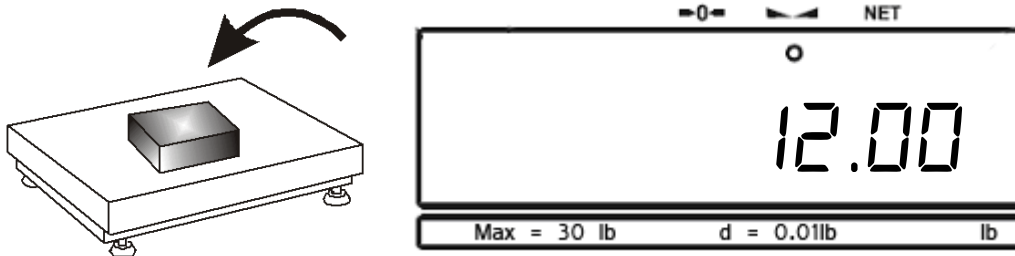

8.2. Taring

1. If a container is used for weighing, it may be tared. In taring the container, the scale subtracts the weight of the container from the gross weight to obtain the net weight.
2. To tare the weighing container, place it in the middle of the pan. The container's weight will be shown on the display.

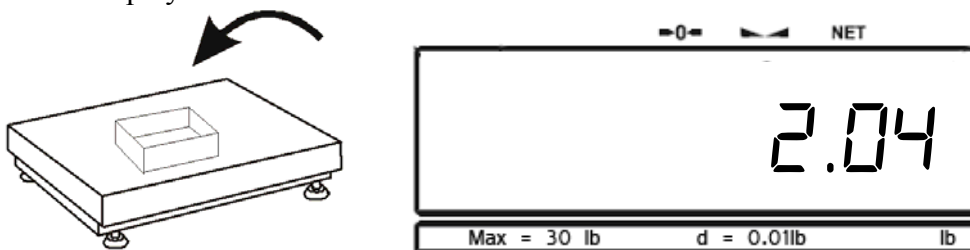

- Once the stabilization indicator appears on the display, the container is ready to be tared. To tare the container, press the “T” button. The display will show a dotted line which indicates the scale has begun the taring process.

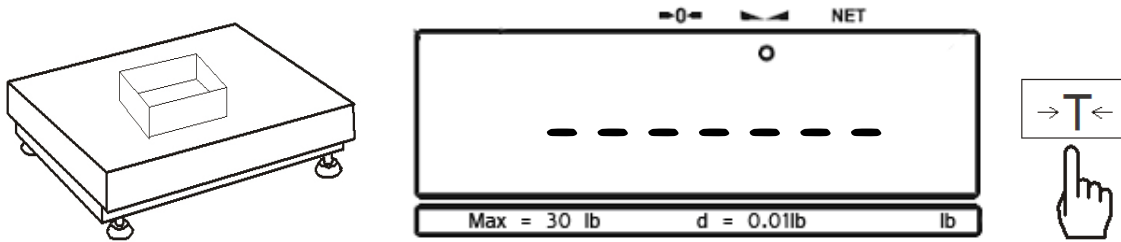

- When finished taring, the balance will return to weighing and the NET indicator will be lit. The display will indicate 0.00g.

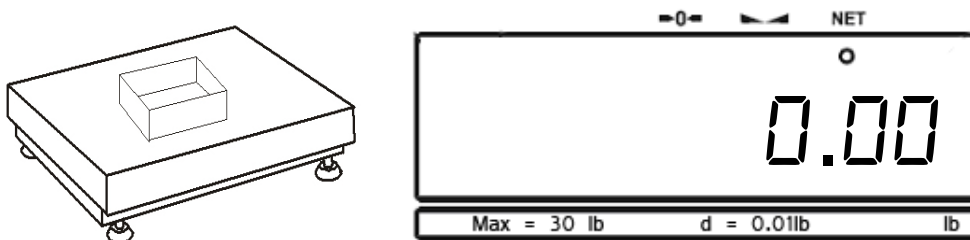

- Place the unknown weight in the tared container. The NET weight will be displayed.

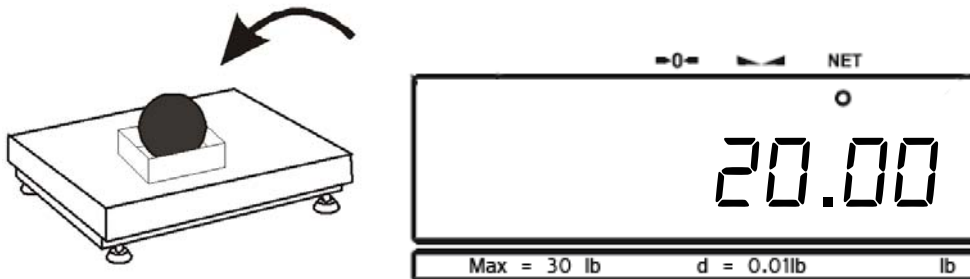

- To obtain the gross weight (Tared container + unknown weight) press the TOGGLE key.

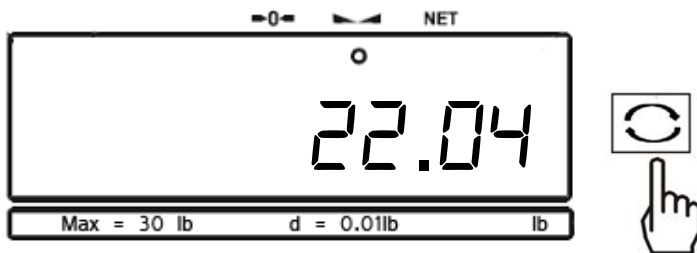

8.3. Extending the resolution

1. The resolution of the scale can be temporarily increased by pressing the HR key. This temporary increase in resolution can be very useful in scales where $d=e$. The display resolution is increased for 5 seconds and then reverts automatically.

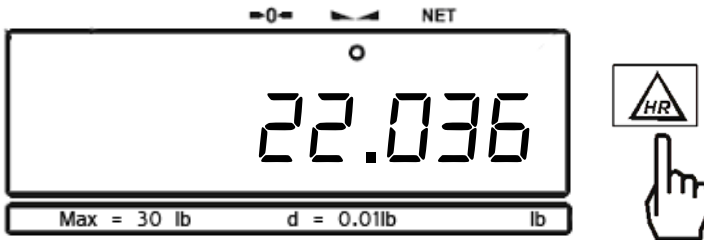

Note: These results are not legal for trade and cannot be sent to a printer or an external computer.

8.4. Zeroing the scale

If the display signals are out of zero condition "--", the scale must be zeroed before weighing.

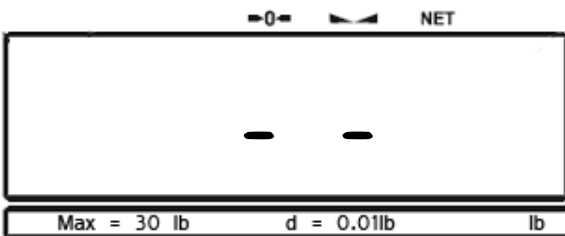

1. To zero the scales press the →0← key.

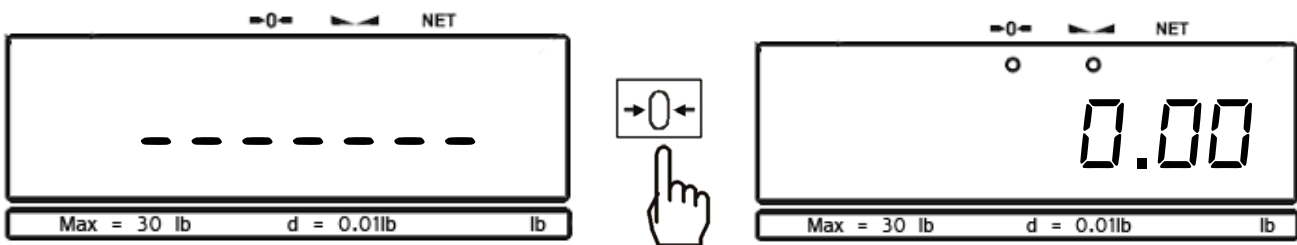

Chapter 9: Auto-zero (AutotA)

The Scale is equipped with AZSM, the “Auto Zero Setting Mechanism.” AZSM automatically maintains a center of zero and it is set to 0.5d/s.

1. Enter the main Menu by pressing the MENU key

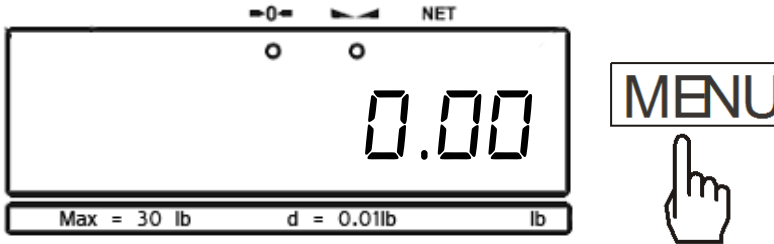

2. Select “AutotA” by pressing the T key.

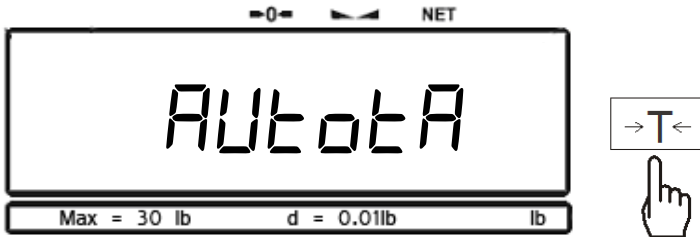

3. To enable Auto-zero press the T key when “Aut on” is displayed, to disable press the T key when “AutoFF” is displayed or select “out” to exit.

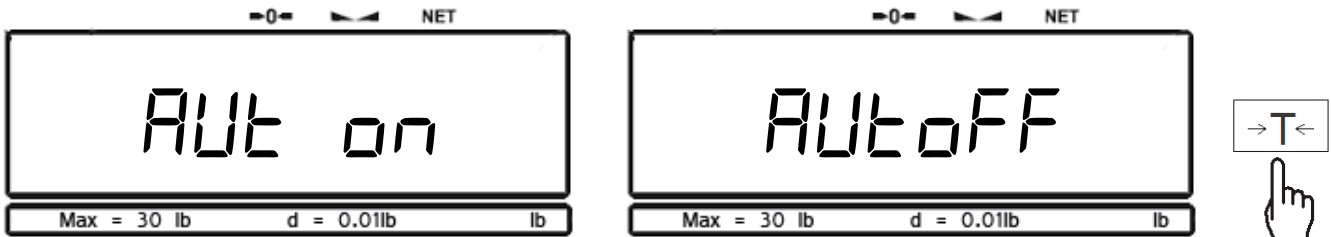

Chapter 10: Parts Counting (PCS)

Functions Options:

PCS Off	(PCS OFF)	Disables Parts Counting
PCS On	(PCS ON)	Enables Parts Counting
PCS ..	(PCS ..)	Recalls the last Average Pieces Weigh used in for counting
PC Set	(PC SET)	Setting a custom sample size
PC UM	(PC UMI)	Setting a custom known Individual Piece Weight
PCS RS	(PCS RS)	obtaining the average piece weight from secondary higher accuracy scale via RS232

10.1. Using a default sample size setting

1. Place the counting container on the pan while in the weighing and press the T key to tare the container.

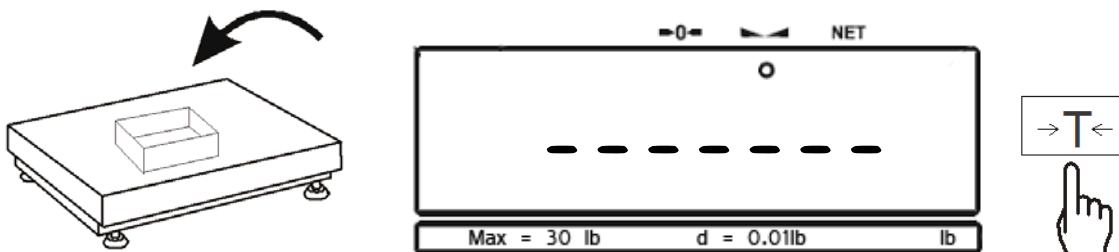

2. Place a sample in the container. The sample size must equal to one of the pre-set options: 5,10,20,50,100, 200,500, and press the MENU key

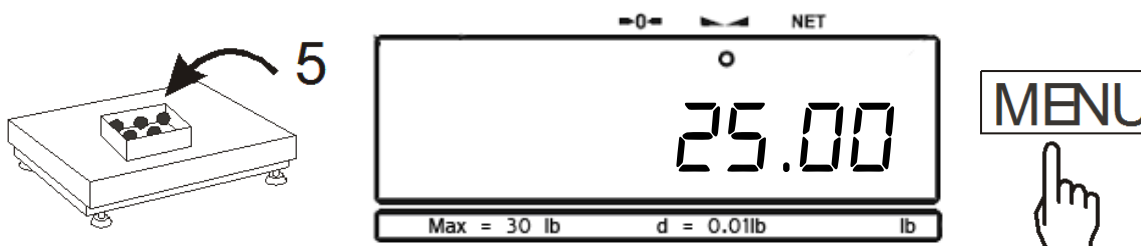

3. Wait for PCS to appear on the display and press the T key

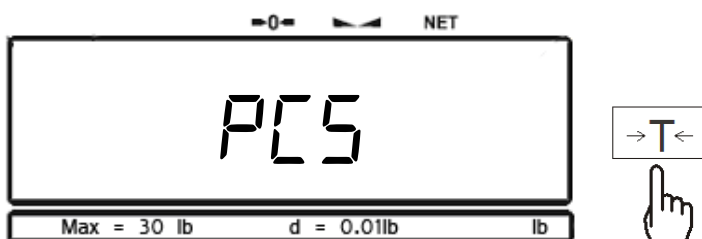

- 4. Select “PCS on” by pressing the T key.

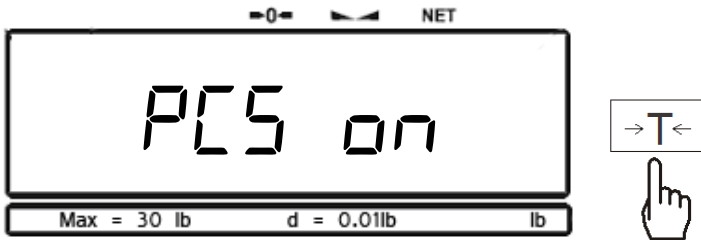

- 5. Available sample size options will alternate on the display. Press the T key to select a size value equal to the number of the sample placed in the container.

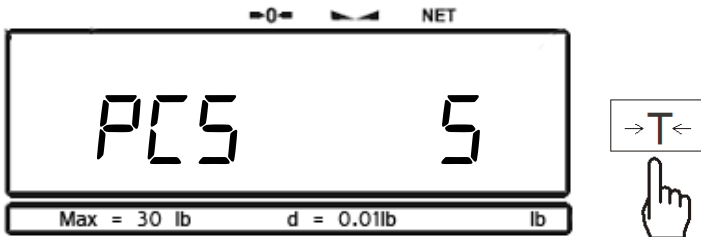

- 6. After the sample size has been selected, the scale will display the count of the sample. At any time you can proceed with the count.

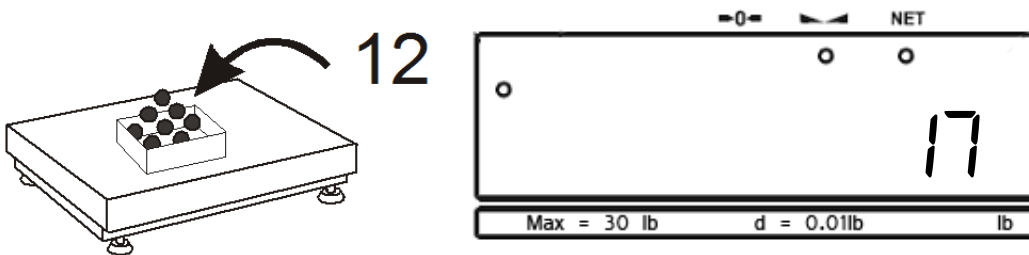

- 7. To turn parts counting off, select PCS from the main menu and press the T key when “PCSoFF” is displayed.

10.2. Using a custom sample size

1. Place the counting container on the pan while in the weighing mode and press the T key to tare the container.

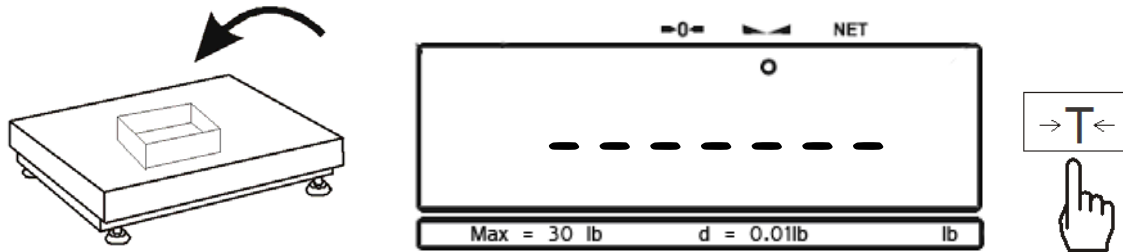

2. Place a desired sample size in the container and press the MENU key. (i.e. 12 as illustrated)

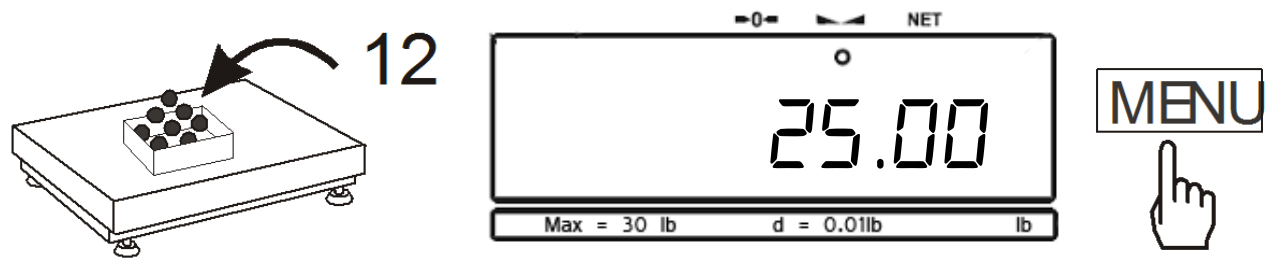

3. Wait for "PCS" to appear on the display and press the T key

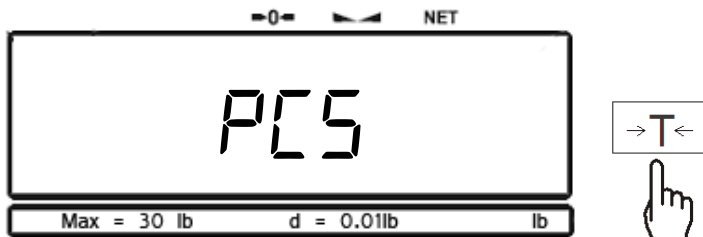

4. Select "PCS on" by pressing the T key.

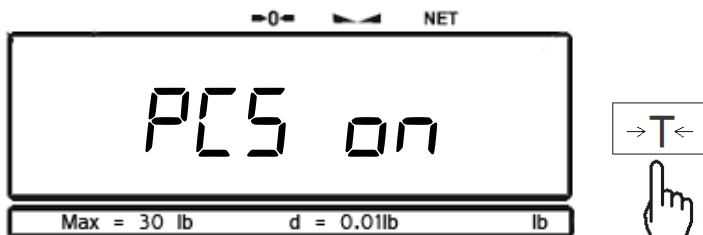

- Available sample size options will alternate on the display. Press the T key when “PC Set” is displayed.

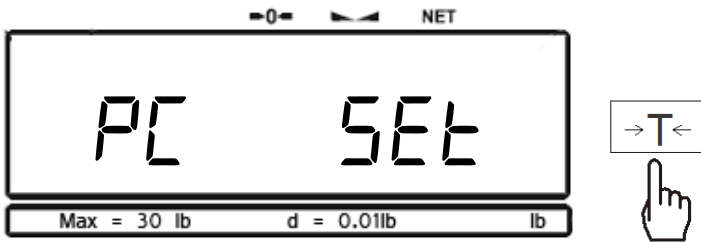

- A dashed line will be displayed indicating to manually enter the value for your sample size in the container. To do so, use the following keys: the →0← key to increment a digit, the T key to accept and go to the next digit, and MENU to accept the entire setting.

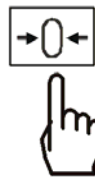

To increment a digit

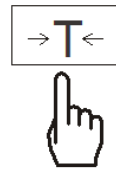

To accept and go to next digit



To accept entered value

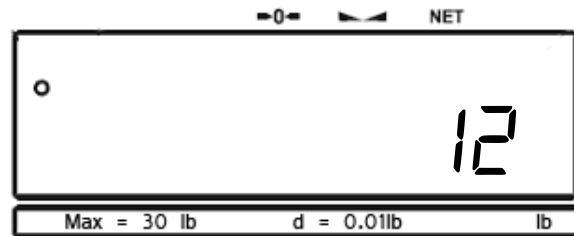
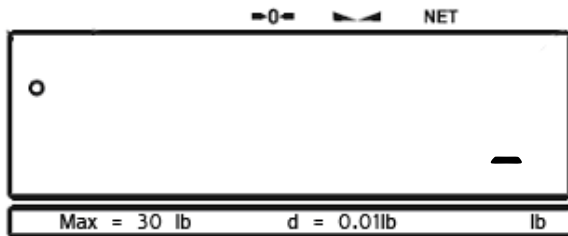

- Once your custom sample size value has been entered and the MENU key pressed, the scale will display the count of the sample. At any time you can proceed with the count.

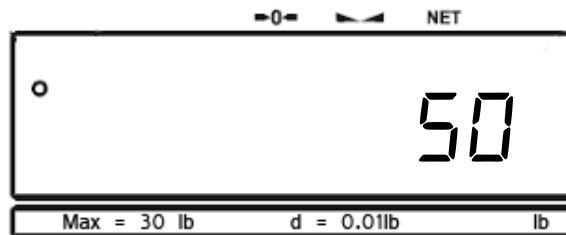
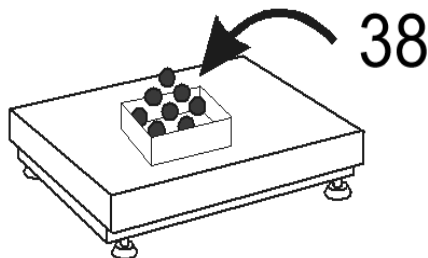

- Once an accurate count has been taken, the container and its contents may be removed from the scale. To Turn parts counting off, select “PCS” from the main menu and press the T key when “PCSoFF” is displayed.

10.3. Counting based on a known Individual Piece Weight (No Sample Size Required)

1. Place the counting container on the pan and press the T key to tare the container.

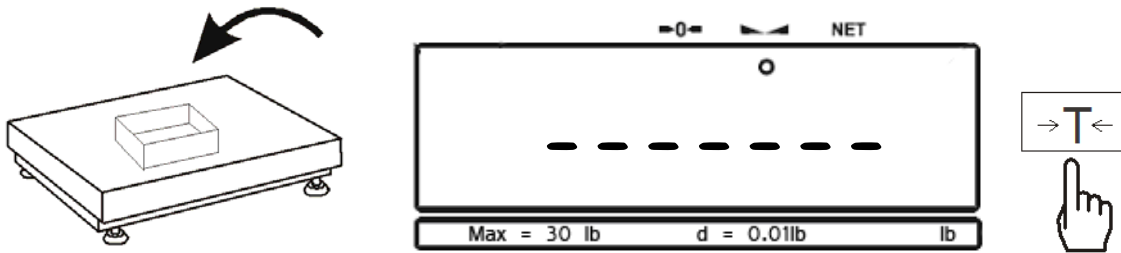

2. Press the MENU key to enter the main menu.



3. Wait for “PCS” to appear on the display and press the T key

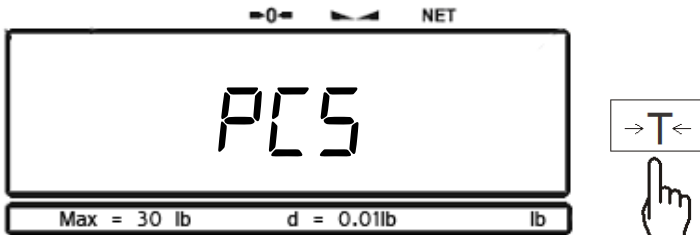

4. Select “PCS on” by pressing the T key.

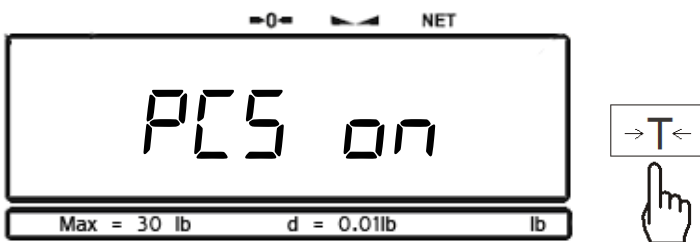

5. Available sample size options will alternate on the display. Press the T key when “PC uM” is displayed.

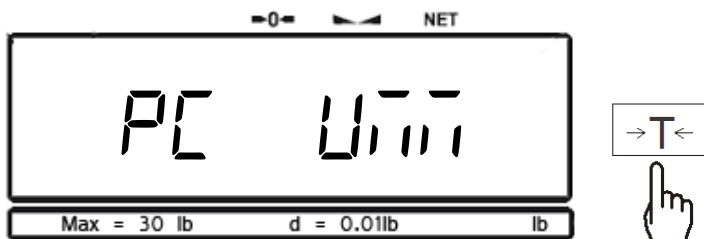

- A dashed line will be displayed indicating to manually enter the exact individual piece weight of the counted parts. To manually enter the individual piece weight, use the following keys: the -->0<-- key to increment a digit, the T key to accept and go to the next digit, the  key to insert a decimal, and the MENU key to accept the entire setting.



To increment a digit

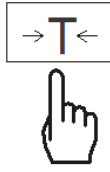

To accept and go to next digit

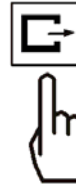

To insert a decimal

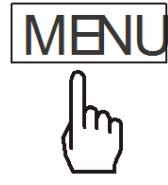

To accept entered value

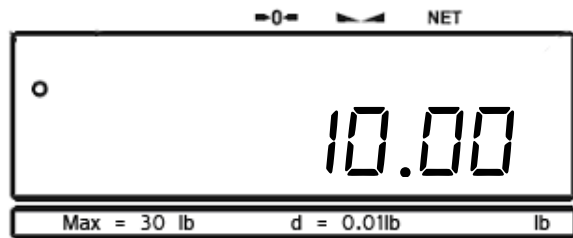
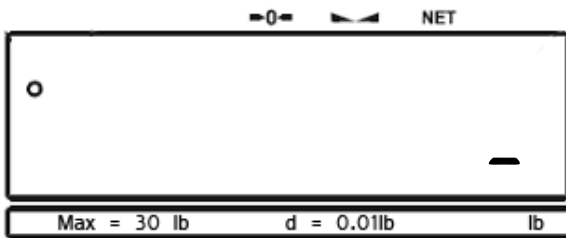

- Once the individual piece weight is entered and the MENU key pressed, the scale will display "0pcs". At any time proceed with the count.

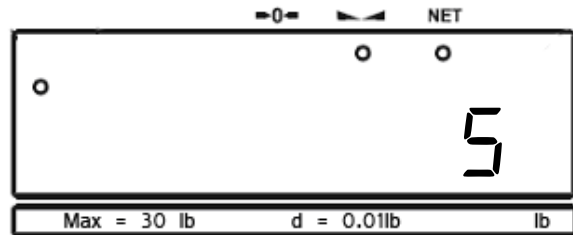
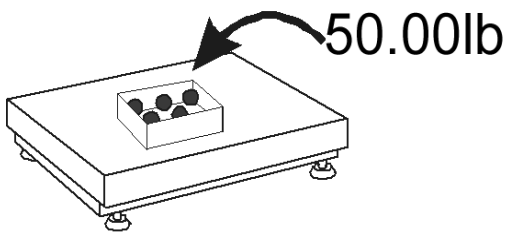

- Once an accurate count has been taken, the container and its contents may be removed from the scale. To exit parts counting and return to basic weighing, select "PCS OFF" from the parts counting menu.

Chapter 11: Units of measure (Units)

The BA Scales can operate in nine different units of measure: Grams (g), Kilograms (kg), Carats (ct), Pounds (lb), Newton, Grains, Ounces, Ounces Troy, Pennyweight. By factory default, the scale is set to weigh in grams (lb). To select a different unit of measure, follow the steps below.

1. Enter the main menu by pressing the MENU key.



2. When command “UNITS” is displayed, press the T key.

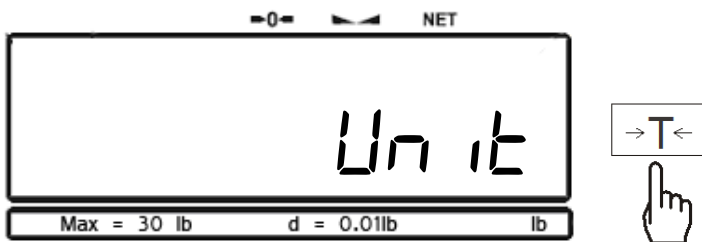

3. The scale will display available units of measure sequentially.

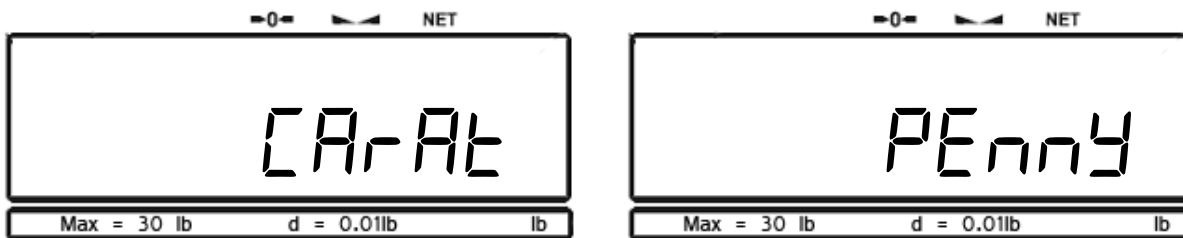

4. When the desired unit is displayed, press the T key to make the selection.

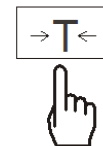

5. Once the selection is made, the scale will automatically return to the weighing mode

Chapter 12: Percent Weighing (PERC)

Function Options:

- PER Off (PEROFF) Disables Percent Weighing
- PER On (PERON) Enables Percent Weighing

Percent weighing is used to express the weight of an object as a percentage of a stored sample weight. To use percent weighing, follow these steps:

1. Place container on the pan and press the T key to tare.

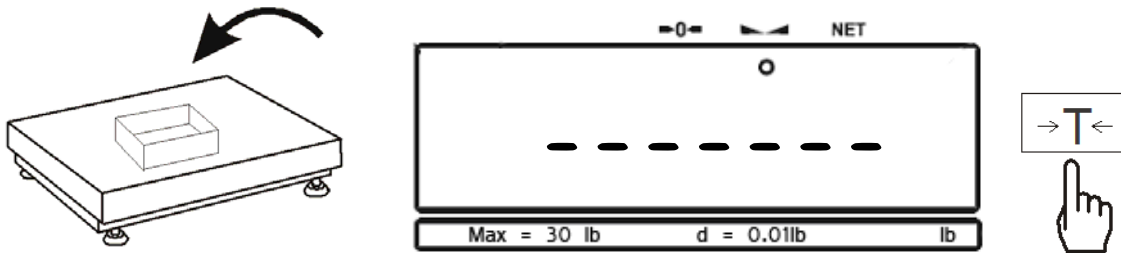

2. Once the scale has been tared, place the sample reference weight on the pan.

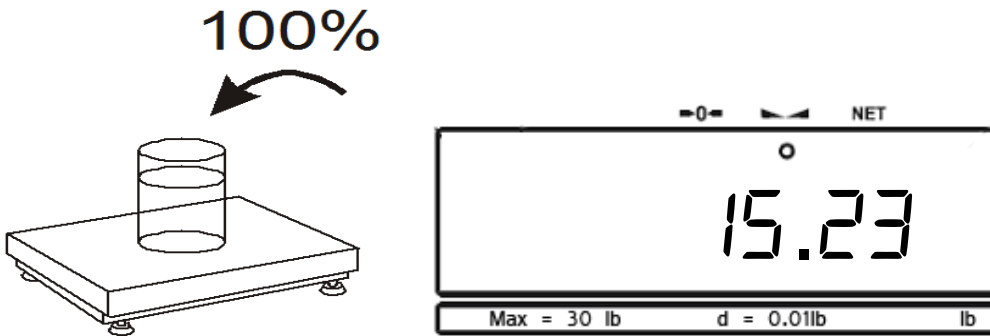

3. The weight of the sample will be displayed as it is placed on the pan. Once the weight of the sample stabilizes and the stability indicator appears on the display, press the MENU key to enter the main menu.

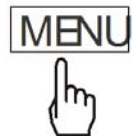

4. When "PERCENT" is displayed, press the T key.

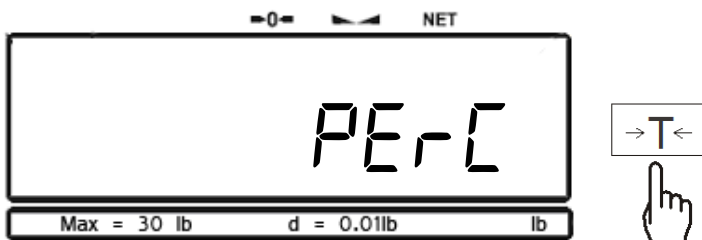

5. Commands “PER OFF” and “PER ON” will be displayed sequentially. To proceed with percent weighing and set the reference sample weight, press the T key when command “PER ON” is displayed.

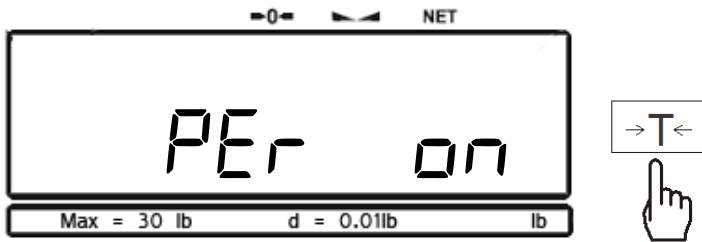

6. Once the reference sample weight is set, the scale will express the weight as a percentage.

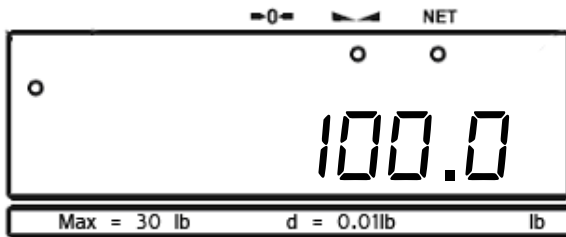

7. Remove the sample and place an object in the container. The scale will express the weight of that object as a percentage of the stored sample.

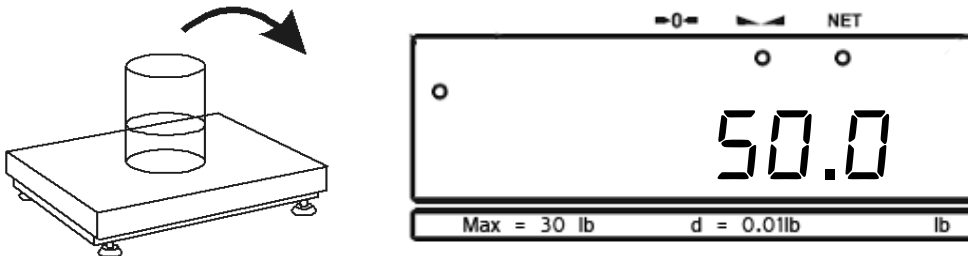

8. To exit percent weighing and return to basic weighing, select “PER OFF” from the percent menu.

Chapter 13: Recipe Weighing (rEC rPE)

Function Options:

Rec Off	(rEC OFF)	Disables Recipe Weighing
Rec On	(rEC ON)	Enables Recipe Weighing
Rec Con	(rEC CON)	allows to continue recipe making after obtaining a total

1. Place the counting container on the pan and press the T key to tare the container.

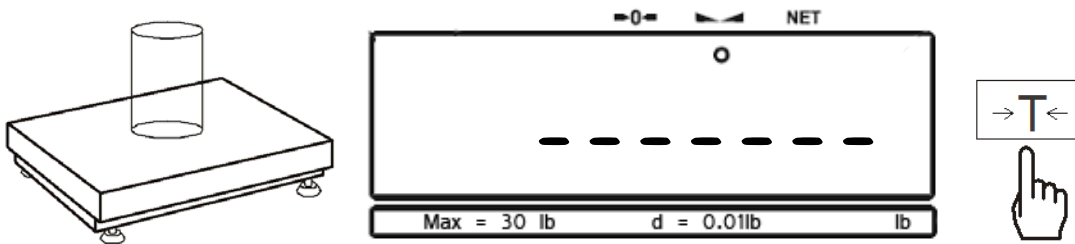

2. Press the MENU key to enter the main menu.



3. Wait for “RECIPE” to appear on the display and press the T key



4. Select “Rec on” by pressing the T key.

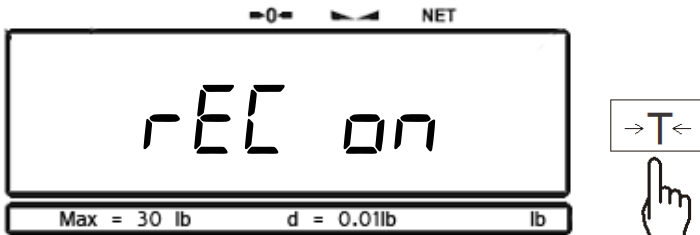

- The display will read 0 indicating that you may place the first ingredient into the container. Once the Weight of the ingredient stabilized press the T key to accept the ingredient weight.

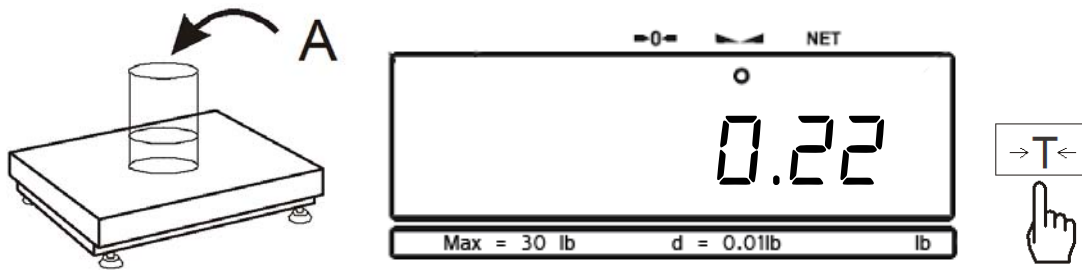

- Once the weight has been accepted place the second ingredient into the container. Once the weight of the second ingredient stabilizes press the T key to accept the ingredient weight.

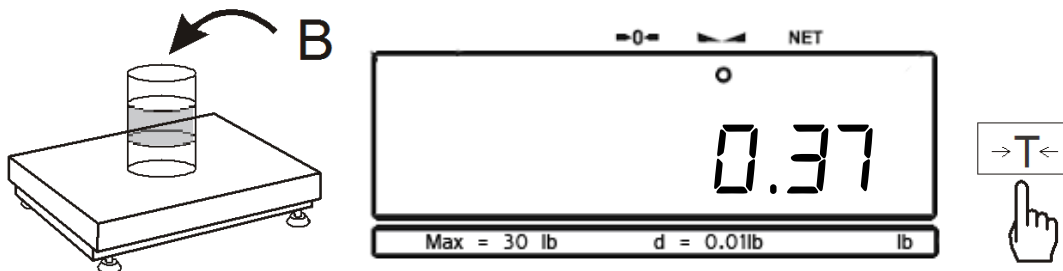

- Steps 1 and 2 can be repeated until all ingredients are in the container. Before obtaining a Total make sure that the last ingredient weight was accepted and the display reads 0.

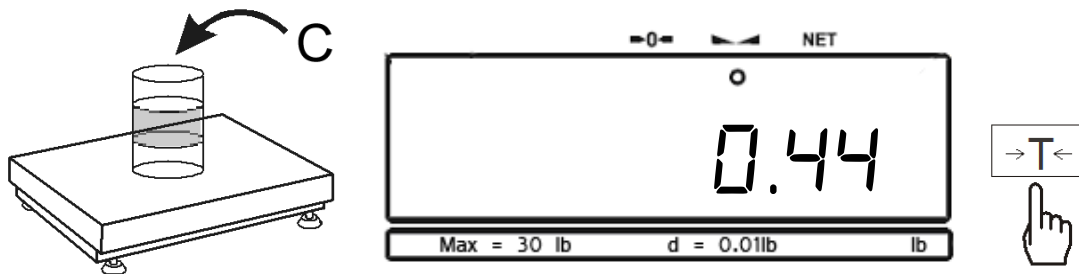

- To obtain the Total for the recipe press the TOGGLE key and the total weight for all of the ingredients will be displayed along with 2 horizontal bars on the left of the display which indicate that the total is being displayed.

Change these to picture below (that was item 9) revised for function light, net light, and left hand bars (2)

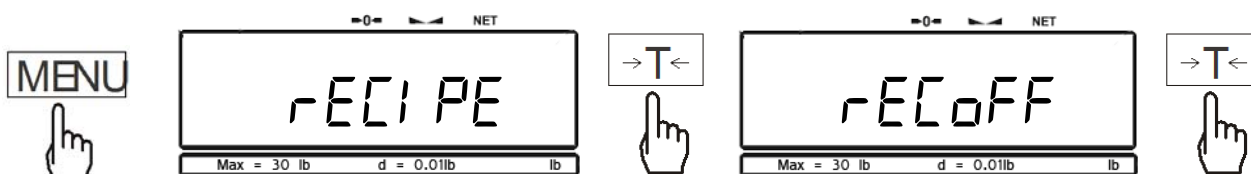

Use above with revisions

A+ B+ C

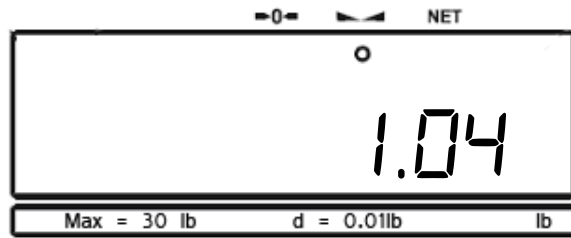
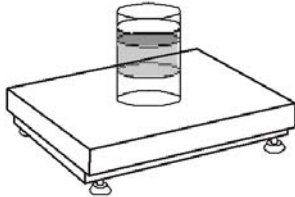

- To continue Recipe making press the TOGGLE key again and the unit returns to the recipe mode with the ingredient weights stored. Repeat steps 5 thru 7 to add more ingredients to the present recipe.

These must be changed.

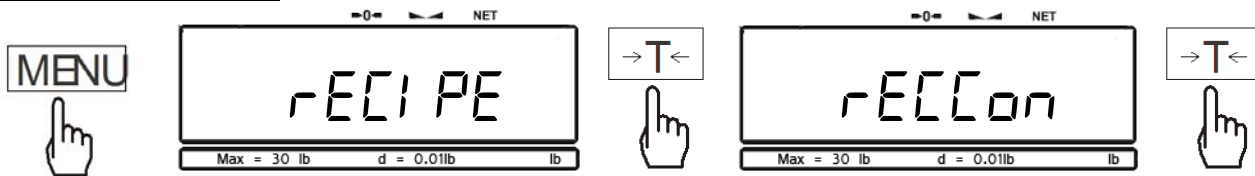

- Repeat step 8 to see the new total at any time and step 9 to resume building the recipe.

- To Clear and start a new recipe, remove all ingredients from the pan and press the Tare key $\rightarrow T \leftarrow$. Once the result is cleared, repeat steps 5 through 9.

Chapter 14: Calibration (CALIB)

Function Options:

CAL On (CAL ON)	Starts Quick Calibration. Recommended when calibrating with a single calibration weight.
CAL Stp (CAL STP)	Starts Stepped Calibration. Recommended when calibrating with multiple calibration weights.
Other (OTHER)	Calibration with calibration mass not equal to the scale's capacity.

Calibration with an external Calibration Weight should be performed if the scale exhibits erroneous readings or periodically to assure accuracy of all weighing results. The scale should be calibrated with a high accuracy weight equal to its maximum capacity. Before starting calibration, have the appropriate calibration weight available.

14.1 Quick Calibration (calibrating with a single calibration weight).

1. Press the MENU key, when the option "Calib" is displayed press the T key, and then select the option "CAL On" by press the T key once again.

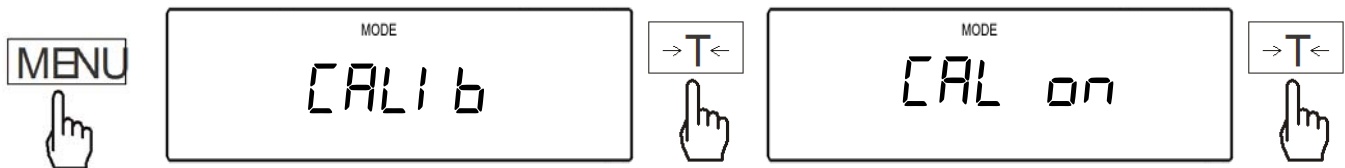

2. The scale will display a full a calibration mass equal to the scales capacity i.e."30", and an option to select a different calibration mass"other". To calibrate the scale with a mass value equal to the scales capacity press the T key when the calibration mass value is displayed (proceed to step 4). To calibrate the scale with a mass lower than the scale's maximum capacity, press the T when "other" is displayed (proceed to step 3).

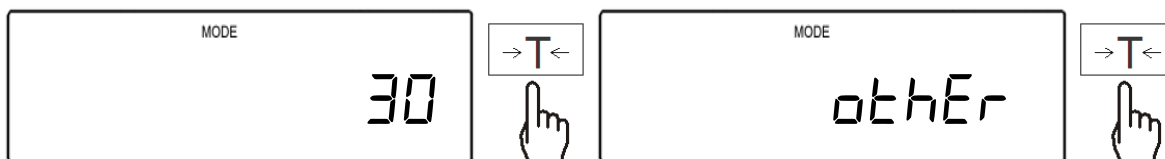

3. If option "other" has been selected a dashed line will be displayed indicating to manually enter the exact value of the calibration mass used to calibrate the scale. To manually enter the calibration value, use the following keys: the -->0<-- key to increment a digit, the T key to accept and go to the next digit, the  key to insert a decimal, and the MENU key to accept the entire setting.

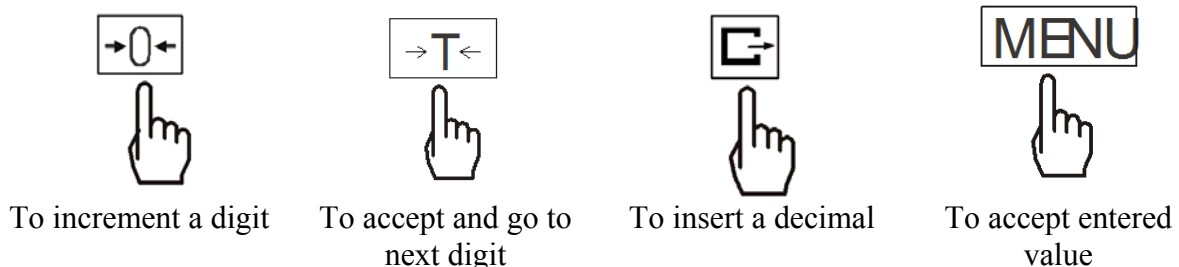

4. The scale will perform a tare and the message “LOAD” will be displayed.

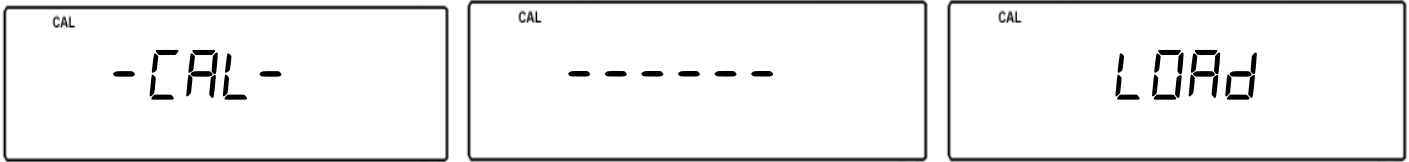

5. When the message “LOAD” is displayed, place the calibration weight on the scale’s hanging pan. Calibration will begin automatically and “WAIT” will be displayed indicating that calibration is in progress.



6. When finished the scale will automatically return to the weighing mode, and the calibration weight can be removed from the pan.

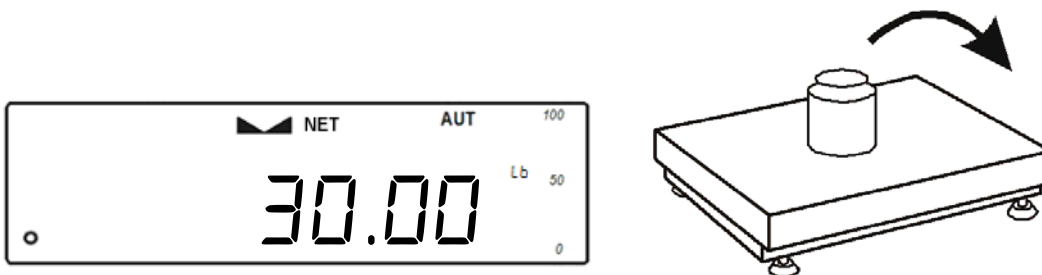

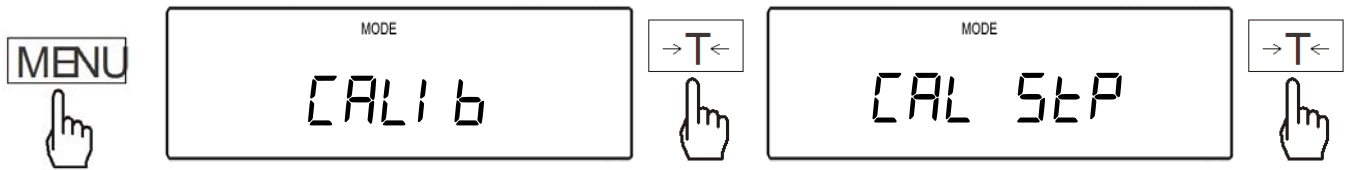

14.2 Stepped Calibration (calibrating with multiple calibration weights.)

1. Press the MENU key, when the option “Calib” is displayed press the T key, and then select the option “CAL Stp” by press the T key once again.

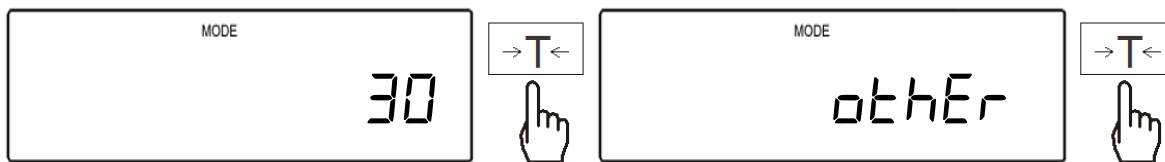

2. The scale will display a full a calibration mass equal to the scales capacity i.e.”30”, and an option to select a different calibration mass”other“. To calibrate the scale with a mass value equal to the scales capacity press the T key when the calibration mass value is displayed (proceed to step 4). To calibrate the scale with a mass lower than the scale’s maximum capacity, press the T when “other” is displayed (proceed to step 3).



3. If option “other” has been selected a dashed line will be displayed indicating to manually enter the exact value of the calibration mass used to calibrate the scale. To manually enter the calibration value, use the following keys: the -->0<-- key to increment a digit, the T key to accept and go to the next digit, the  key to insert a decimal, and the MENU key to accept the entire setting.

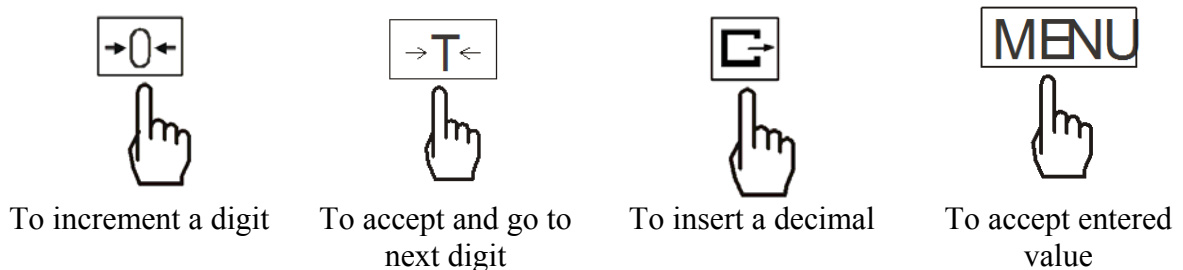

4. The scale will display the message “Press Menu”. When you are ready to Tare the scale Press the MENU key.

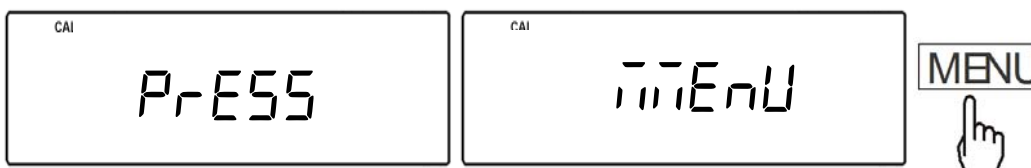

- The scale will perform a tare and the message “LOAD” will be displayed indicating to place all calibration weights on the pan. After placing all weights on the pan, press the Menu key to initiate the calibrations process.

Caution: Do not press Menu until all calibration weights are on the scale’s pan

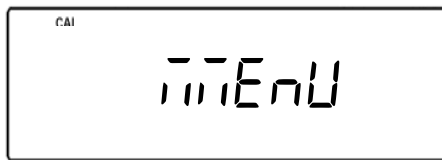
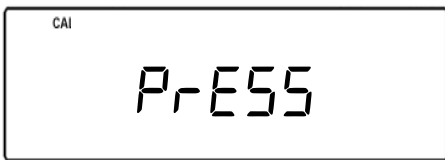
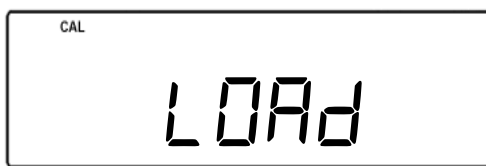
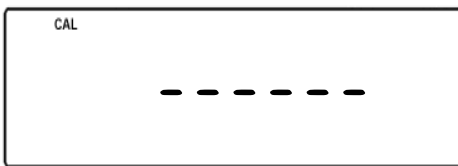
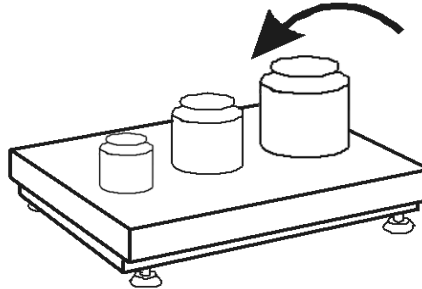

- Message “CCCCCC” will be displayed indicating that calibration is in progress. When finished the scale will automatically return to the weighing mode and the calibration weights can be removed from the pan.

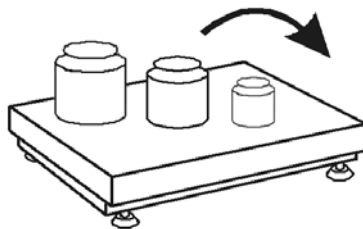
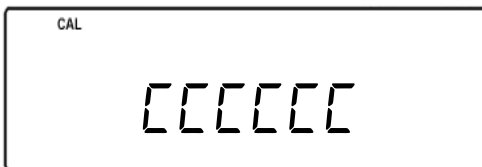

Chapter 15: Port 1 - RS232 Communication Port Configuration (Port- 1)

After a weighing transaction is completed, a result data receipt can be printed. To initiate printing, press the data transfer key. Data may be sent to a printer or a PC via the Torbal Communication Software.



15.1. Data Transmission and Exchange Protocol

Data Transmission (LONG):

Transmission Parameters: 8 bits, 1 stop bit, no parity, baud rate 4800bps,

Exchange data:

- Transmit the weight (equivalent to the Print Key, , in weighing:
Computer→Scale: **S I** CR LF (53h 49h 0Dh 0Ah) – initiating signal,
Scale→Computer: scale sends 16 Bytes of data as follows:

Byte	1	- The character '-' or space
Byte	2	- space
Bytes	3,4	- digit or space
Bytes	5-9	- digit, comma, or space
Byte	10	- digit
Byte	11	- space
Byte	12	- k, l, c, p or space (for kg,lb,ct,pc, or%)
Byte	13	- g, b, t, c or %
Byte	14	- space
Byte	15	- CR
Byte	16	- LF

- 'Tare the weight' (corresponds to the →T← key in weighing):
Computer→Scale: **S T** CR LF (53h 54h 0Dh 0Ah),
Scale→Computer: no response.
- 'Zero the scale' (corresponds to the key →0← in weighing):
Computer→Scale: **S Z** CR LF (53h 5Ah 0Dh 0Ah),
Scale→Computer: no response.
- 'Turn On / Off the Scale (corresponds to the key I/⏻ in weighing):
Computer→Scale: **S S** CR LF (53h 53h 0Dh 0Ah),
Scale→Computer: no response.
- 'Display the MENU' (corresponds to the key *MENU* in weighing):
Computer→Scale: **S F** CR LF (53h 46h 0Dh 0Ah),
Scale→Computer: no response.
- Setting the threshold 1 (optional):
Computer→Scale: **S L DI...DN** CR LF (53h 4Ch *DI...DN* 0Dh 0Ah)
where: *DI...DN* – Threshold value, up to 8 characters,

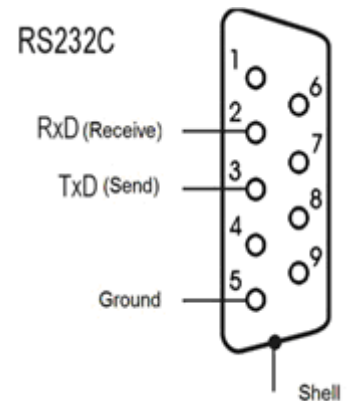

Scale→Computer: no response,

▪ Example:

To set 1000g in weight B1.5 (d=0.5g) type:

S L 1 0 0 0 . 0 CR LF (53h 4Ch 31h 30h 30h 30h 2Eh 30h 0Dh 0Ah).

To set 100kg in weight B150 (d=50g) type:

S L 1 0 0 . 0 0 CR LF (53h 4Ch 31h 30h 30h 2Eh 30h 30h 0Dh 0Ah),

▪ Setting the threshold 2 (optional):

Computer→Scale: **S H *DI*...*DN*** CR LF (53h 48h *DI*...*DN* 0Dh 0Ah),

where: *DI*...*DN* – threshold value, up to 8 characters,

Scale→Computer: no response

Cable WK-1 Configuration

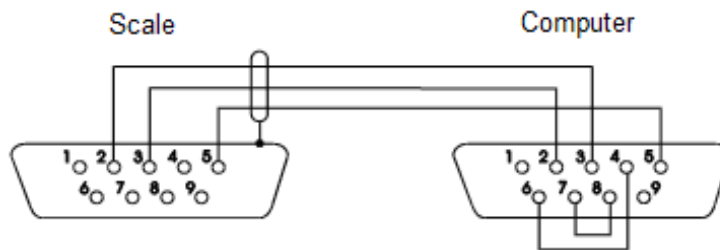

Cable WD-1 Configuration

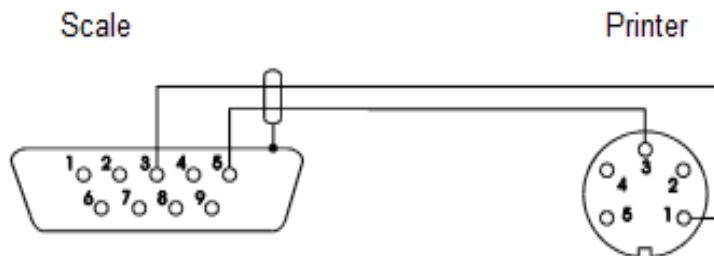

15.2. Baud Rate

1. Press the Menu key, when the option “Port - 1” is displayed press the T key, and then select the option “Baud” by press the T key once again.

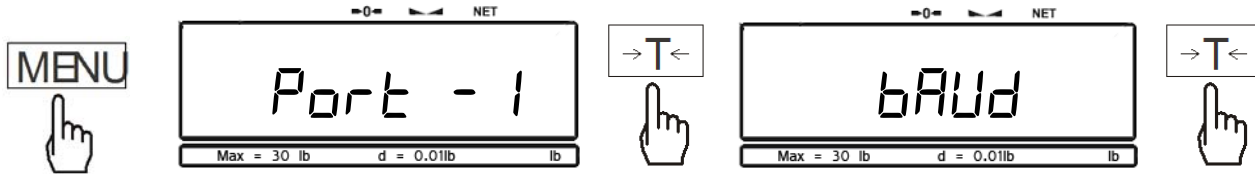

2. The scale will begin to display available baud rates: “4800”, “9600”, “19200”, “38400”, and “57600”. To make a selection, press the T key when the desired setting is displayed.

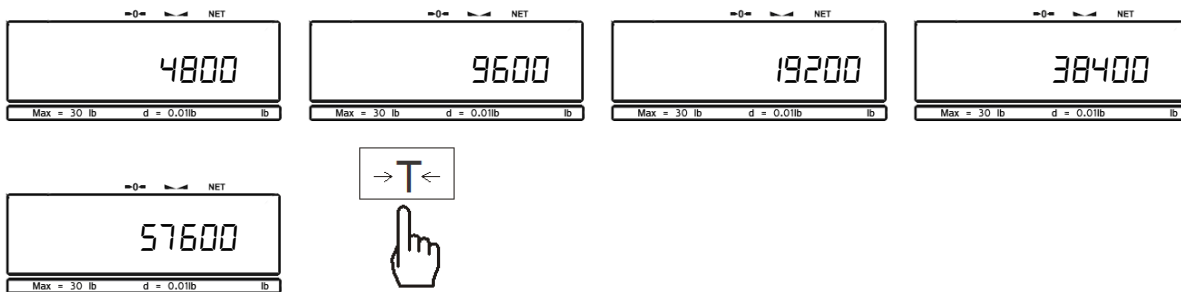

15.3. Bites

1. Press the MENU key, when the option “Port - 1” is displayed press the T key, and then select the option “Bites” by press the T key once again.

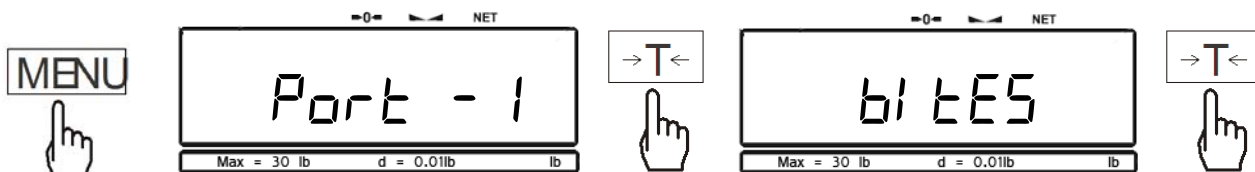

2. The scale will display available Bits settings: “7-bit”, “8-bit”. To make a selection press the T key when the desired setting is displayed.

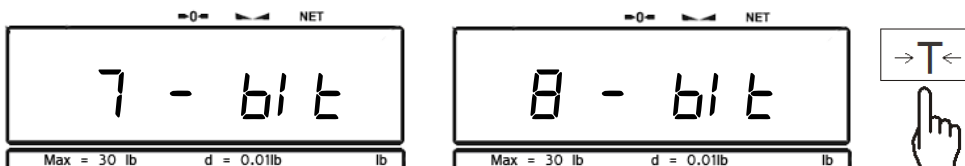

15.4. Parity

1. Press the MENU key, when the option “Port - 1” is displayed press the T key, and then select the option “Parity” by press the T key once again.

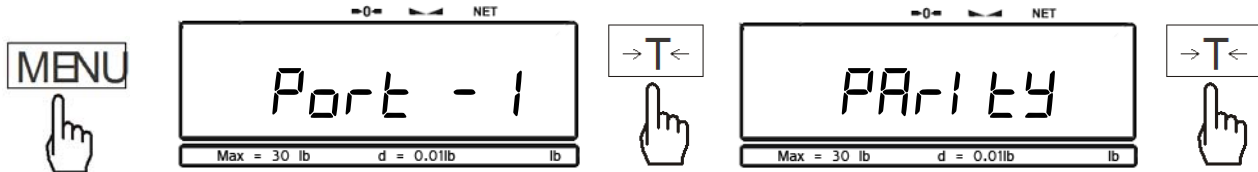



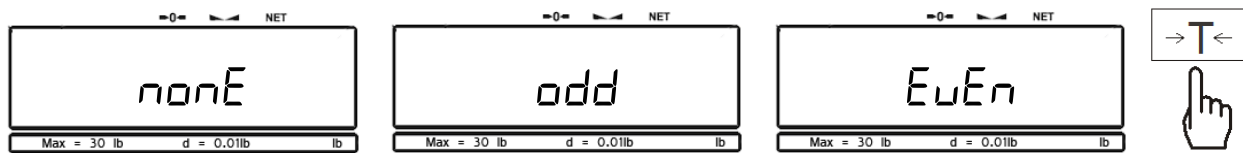



2. The scale will display available Parity settings: “none”, ”odd”, “even”. To make a selection press the T key when the desired setting is displayed.

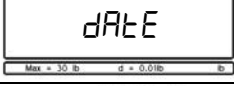
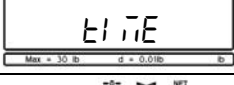
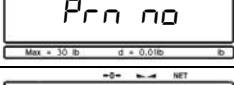
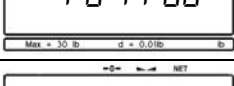
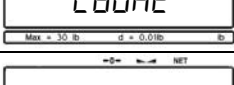
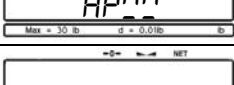
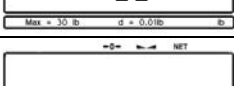
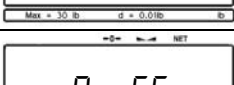

There is no description of the send function

Chapter 16: Receipt Printout (Print)

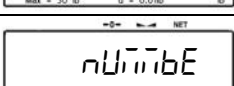
A detailed transaction receipt can be printed after weighing has been completed. The receipt can be customized to include the following information:

	Header – includes unit information such as: Mode number, Max Capacity, resolution and Unit Serial number.
	Operator Id – shows the ID number of the user which performed the weighing transaction
	Date – Date of the performed transaction
	Time – Time at which the transaction was performed
	Printout number – Number of the receipt printed in a given day
	Product Id – ID number of the product or item weighed
	Count – Result obtained in Parts Counting
	APW – Average Piece weight of the counted parts in the Parts Counting Functions
	Net – Net result of the weighing transaction
	Tare – tared weight in the weighing transaction
	Gross – gross weight of the weighing transaction
	Total – grand total obtained in the totalizing function
	Number – number of measurements

16.1. Enabling and Disabling Receipt Fields

1. Press the MENU key, when the option “Print” is displayed press the T key, and then select a desired field by press the T key once again when the name is displayed.

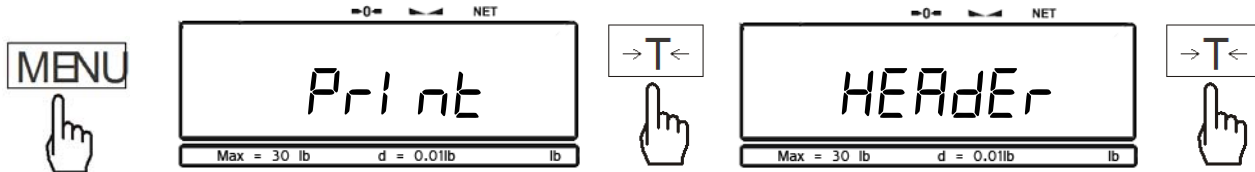

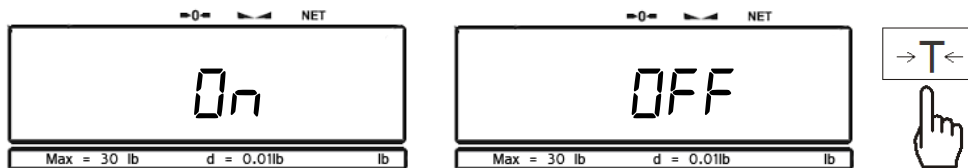

2. The scale will display options “ON” and” Off”. To enable the field press the T key when “On” displayed, to disable the field press the T key when “Off” is displayed.

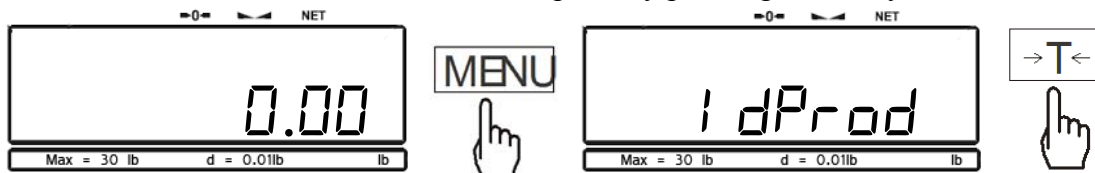

16.2. Assigning Operator and Product ID numbers.

1. From the weighing mode press and hold the MENU key for 3 seconds or until the scales displays “IDPROD” and “IOPER”. Select the desired option by pressing the T key.



2. A dashed line will be displayed indicating to manually enter ID number. To manually enter the ID number, use the following keys: the -->0<-- key to increment a digit, the T key to accept and go to the next digit, the  key to insert a decimal, and the MENU key to accept the entire setting.

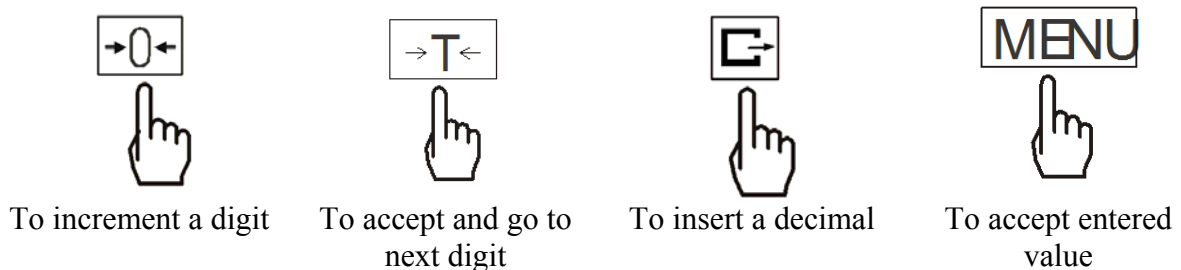

Chapter 17: Dynamic and Animal Weighing (LOC)

Function Options:

- LOC Off (LOC OFF) Disables the LOC Dynamic Weighing Function
- LOC On (LOC ON) Enables and Starts the LOC Dynamic Weighing Function (Weight integration initiates automatically)
- LOC Prn (LOC Prn) - Enables and Starts the LOC Dynamic Weighing Function (Weight integration is initiated manually with the press of the Data Transfer Key )

1. Place a container on the pan and press the T key to tare.

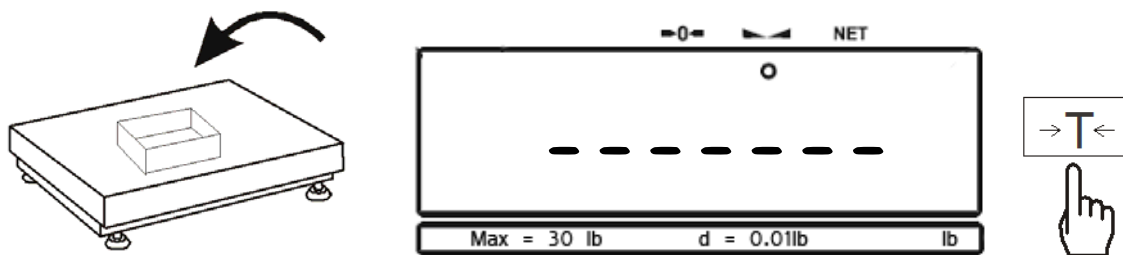

2. Press the MENU key, when the option “LOC” is displayed press the T key, and then select the option “LOC On” or “LOC Prn” by press the T key once again.

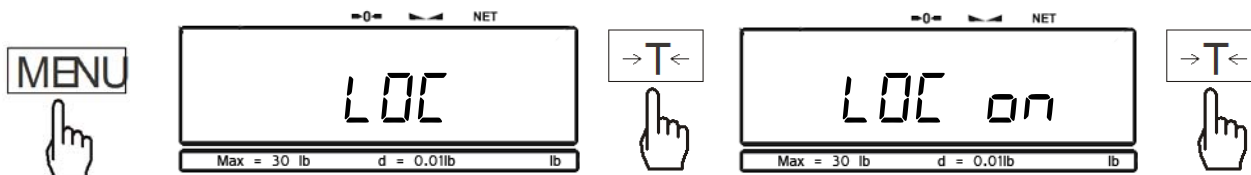

3. Place the animal or the moving object on the pan. Weight integration will begin automatically. If “LOC Prn” was selected press the data transfer key  to initiate weight integration manually. While the scale is integrating the weighing result the display flashes.

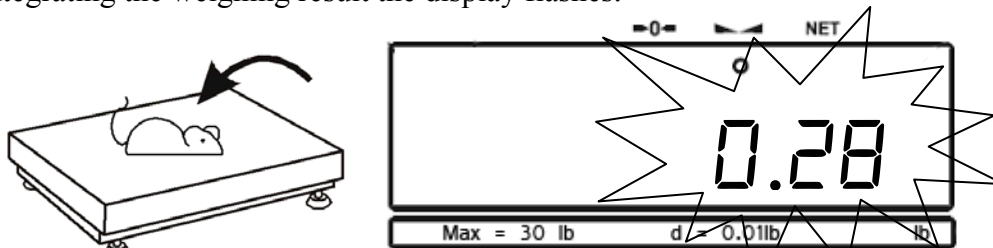

4. Final result will be automatically sent to a printer or a PC via the RS232 port. During data transmission the word print will be displayed. The final result remains displayed for 30 seconds. To perform the next weighing remove the animal, wait for the scale to display 0 and place the next animal on the pan.

Chapter 18: Storing Tare Values (tArE)

18.1. Storing a Tare Value Manually

1. Press the MENU key, when the option “Tare” is displayed press the T key, and then select the option “Tar Set” by press the T key once again.

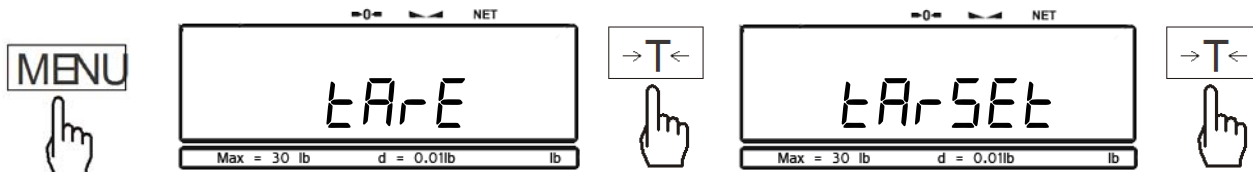

2. The scale will begin to display tare locations. Locations marked with a dot in the upper left corner of the LED have a stored tare value assigned. To select a tare location or overwrite a current location press the T key when a desired location is displayed, and then select the option “Manual” by press the T key once again.

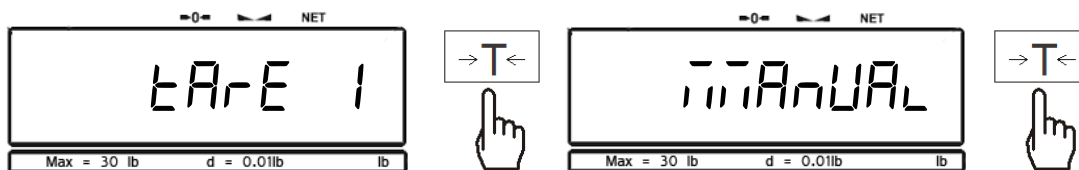

3. A dashed line will be displayed indicating to manually enter the Tare value. To manually enter tare value, use the following keys: the -->0<-- key to increment a digit, the T key to accept and go to the next digit, the  key to insert a decimal, and the MENU key to accept the entire setting.

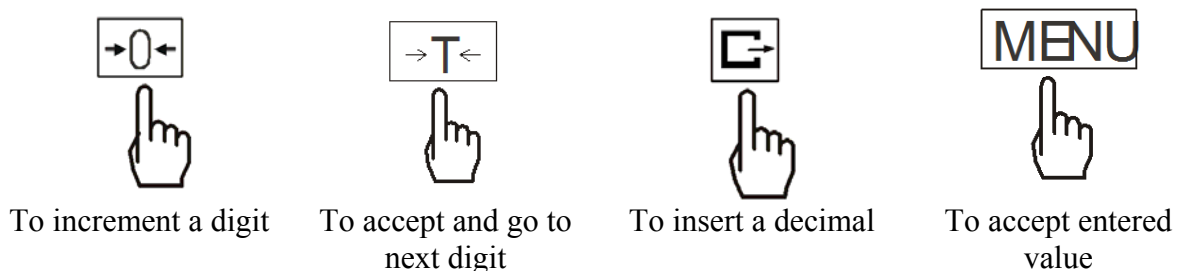

4. Once a tare value has been assigned, the scale will automatically store the value in the selected memory location and return to the weighing mode with the tare value in use.

18.2. Storing a Tare Value Automatically

1. Place a container on the pan and press the MENU key to enter the main menu.

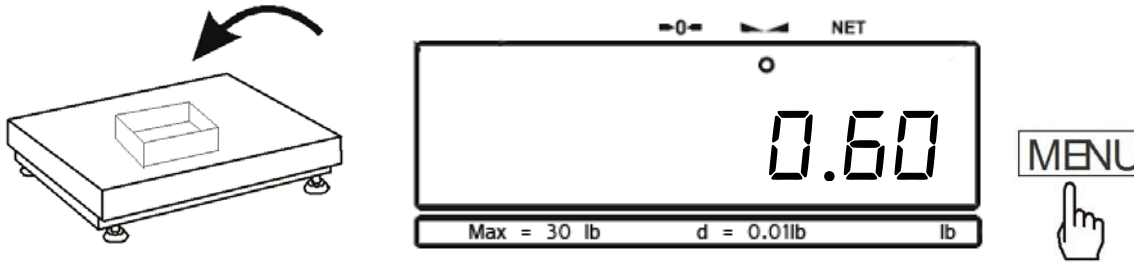

2. When the option “Tare” is displayed press the T key, and then select the option “Tar Set” by pressing the T key once again.

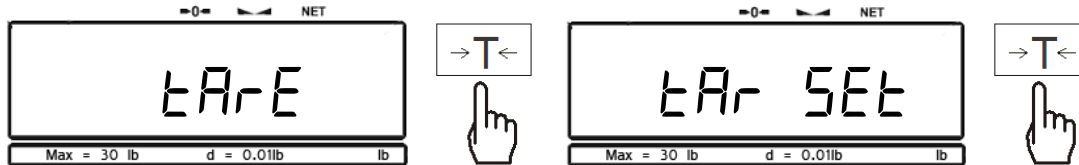

3. The scale will begin to display tare locations. Locations marked with a dot in the upper left corner of the LED have a stored tare value assigned. To select a tare location or overwrite a current location press the T key when a desired location is displayed, and then select the option “Pan” by press the T key once again.

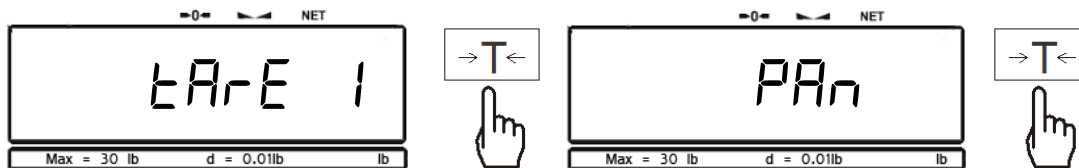

4. The scale will automatically store the value of the container on the in the selected memory location and return to the weighing mode with the tare value in use.

18.3. Recalling a previously stored tare value.

1. Press the MENU key, when the option “Tare” is displayed press the T key, and then select the option “Tar On” by press the T key once again.

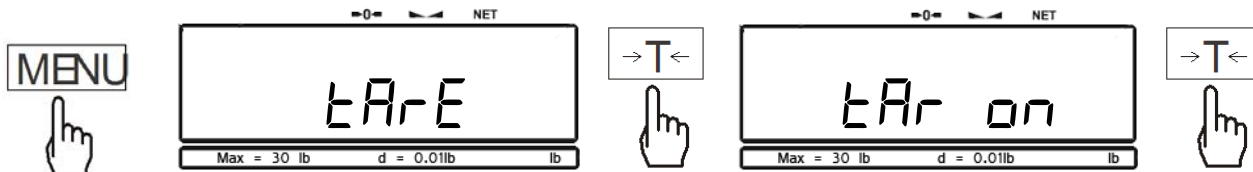

2. The scale will begin to display tare locations. Locations marked with a dot in the upper left corner of the LED have a stored tare value assigned. To select a tare location press the T key when a desired location is displayed.

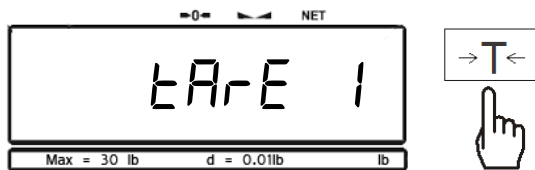

3. The scale will return to the weighing mode with the selected tare value in use.

What is “tar ..” ?

Chapter 19: Min – Max Weighing (UP)

This function allows you to find the maximum (highest) or minimum (lowest) weight in a series of weights.

1. Press the MENU key. When the option “Up” is displayed press the T key, and then select the option “High” or “Low” by press the T key once again.

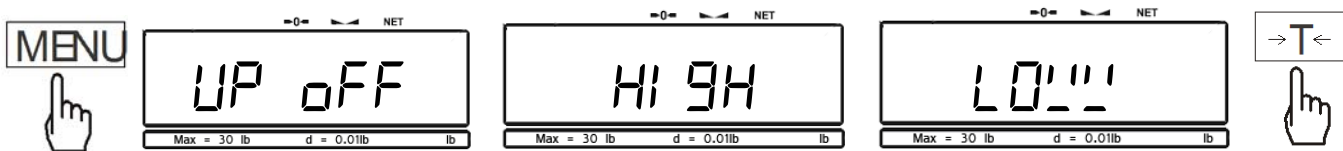

2. The scale will return to weighing and it will begin to hold on the display the highest or the lowest weight. When seeking the highest weight in a series make sure to remove the previous weight from the pan before adding the new weight. When seeking the lowest value weight be sure to add the new weight before removing the previous weight.

Note: Add and remove weights with care in order not to increase the weight unintentionally.

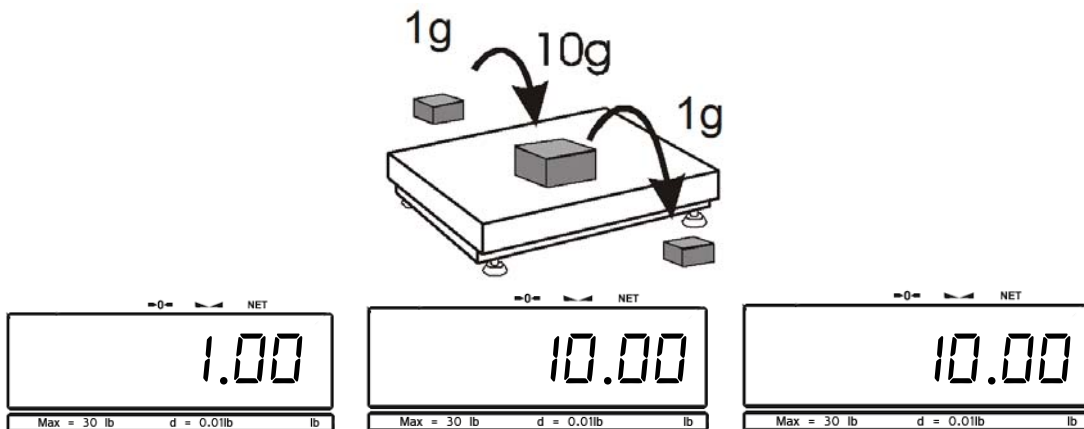

Note: Stability indicator and Auto-Zero is disabled during Min/Max weighing.

Chapter 20: Newton – Force Measurement (nE'""t0)

This function changes the unit of weight to Newton (N) - $1\text{N} \approx 0.101971\text{ kg}$

1. Press the MENU key, when the option “Newton” is displayed press the T key.

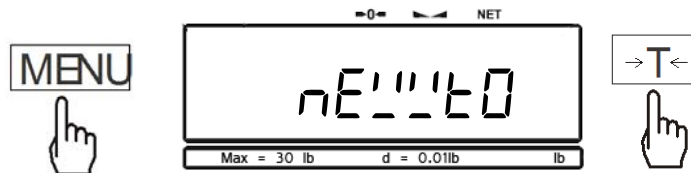

2. The scale will display options “ON” and” Off”. To enable Newton force measuring press the T key when “New On” displayed, to disable Newton force measuring press the T key when “New Off” is displayed.

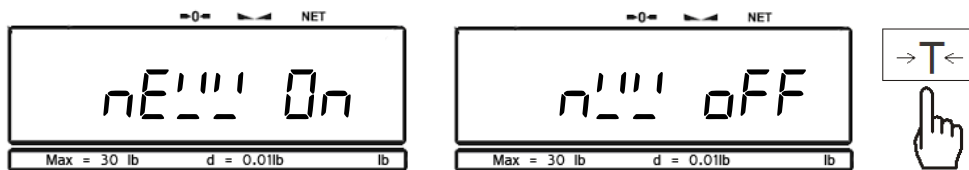

Chapter 21: Filtering (F*Lt*Er)

This function is used when vibration is encountered during weighing. This may be the result of ground vibration, or a vibrating live load on the pan. Increasing the filter setting will increase the time required for a measurement. The integration time of the measurement is increased thereby eliminating higher frequency vibration.

1. Press the MENU key, when the option “Filter” is displayed press the T key.

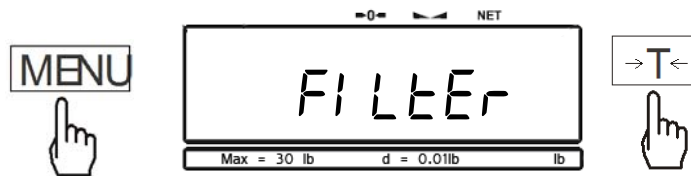

2. The scale will display options “Off” and available filter sensitivity levels “Fil 10, Fil 20, Fil 30 and Fil 40”. To select and enable Filtering press the T key when a desired filter level is displayed.

<i>Filter</i>	<i>Sensitivity</i>
Fil 10	Low
Fil 20	Medium
Fil 30	High
Fil 40	Severe

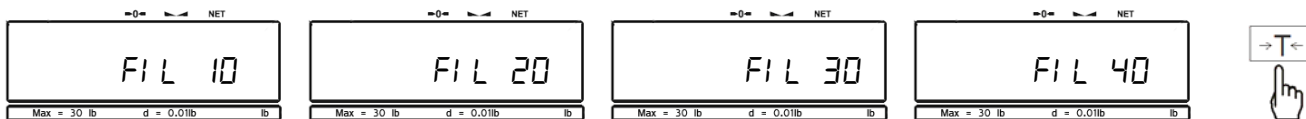

3. To disable filtering select “Fil Off” from the filter menu.

Chapter 22: Date and Time (dAtE)

Function Options:

Dat On	(dAt On)	Enables date and time printing with every weighing result.
Dat Off	(dAt OFF)	Disables date and time printing.
Dat Set	(dAtSEt)	Date configuration” allows to set the current date and time.
Dat Pin	(dAtPi n)	Enables PIN access to the Date Configuration.
Dat For	(dAtFOR)	Format selection (United States / Europe).

22.1. Enabling and Disabling Date and Time stamping

1. Press the MENU key, when the option “Date” is displayed press the T key.

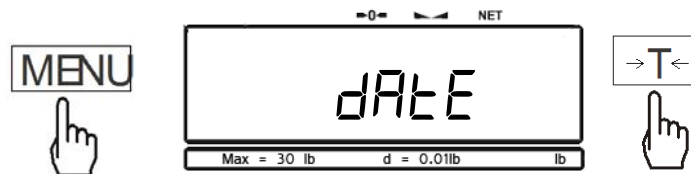

2. The scale will display options “Dat On, Dat Off, Dat Set, Dat Pin, Dat For” . To enable Date stamping press the T key when “Dat On” is displayed, to disable press the T key when “Dat Off” is displayed.

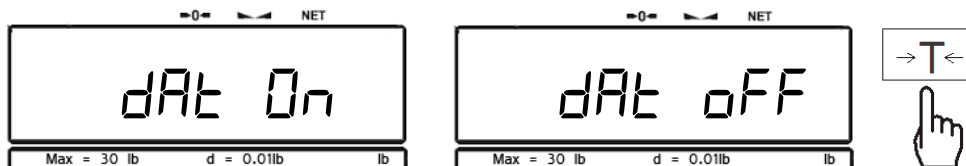

22.2. Setting the current date and time

1. Press the MENU key, when the option “Date” is displayed press the T key, and then select the option “Dat Set ” by press the T key once again.

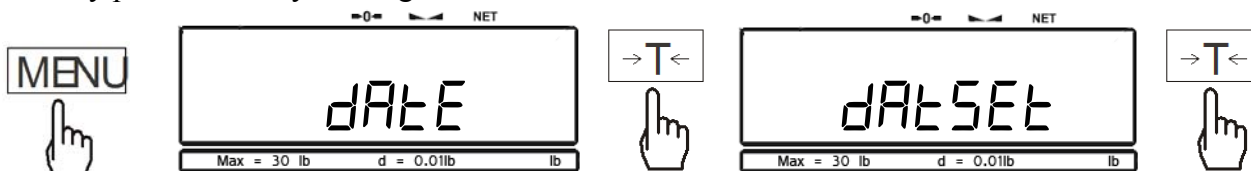

2. The current time will be displayed. To change or to set a new time press the T key

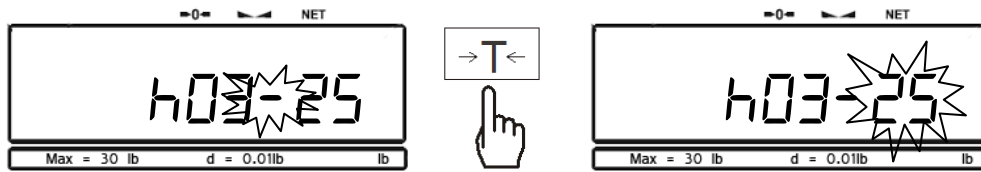

3. Use the following keys to change the current time

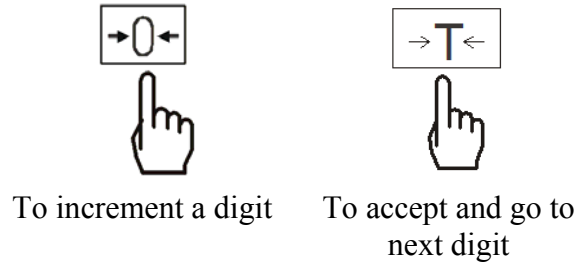

4. Once the time has been set the scale will display "PM" or "AM". Press the T key when the desired setting is displayed.

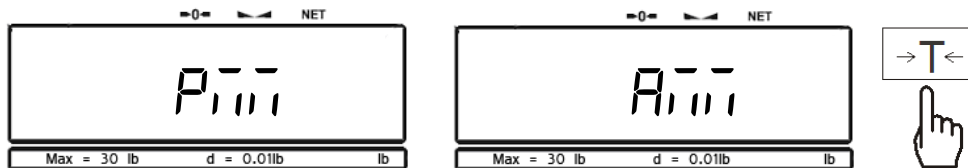

5. Once the Time has been set, the scale will display the current date. To change or to set a new date press the T key

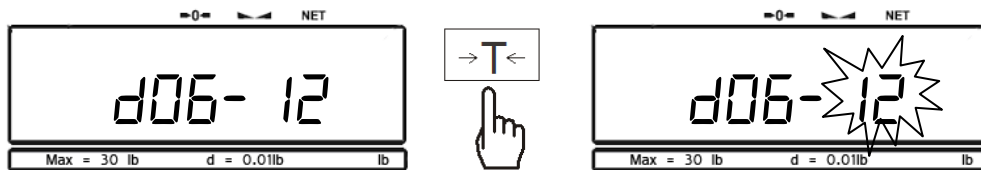

6. Use the following keys to change the date

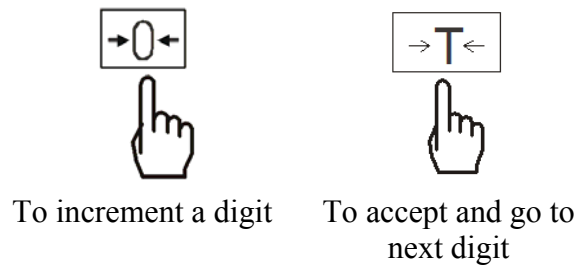

- Once the time has been set the scale will display the current year. To change the years press the T key.

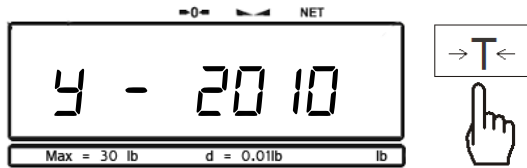

22.3. Enabling PIN access to the Date Configuration Function.

Configuration of the current date and time can be protected with a PIN. Once set the user is prompted to enter a pin number before time and date change is allowed.

- To Set PIN for date configuration press the MENU key. When the option “Date” is displayed press the T key, and then select the option “Dat PIN ” by press the T key once again.

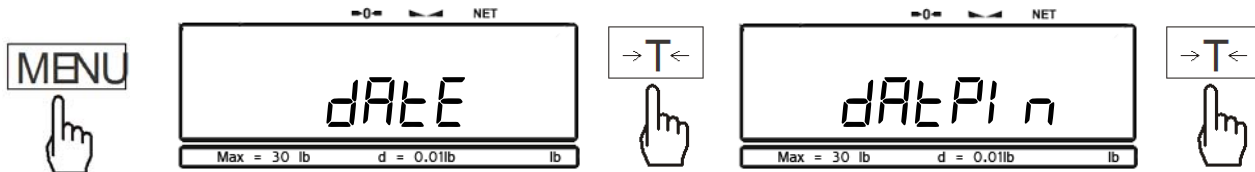

- The scale will display a dashed line indicating to enter a desired PIN. To enter the PIN, use the following keys: the -->0<-- key to increment a digit, the T key to accept and go to the next digit, the  key to insert a decimal, and the MENU key to accept the entire setting.

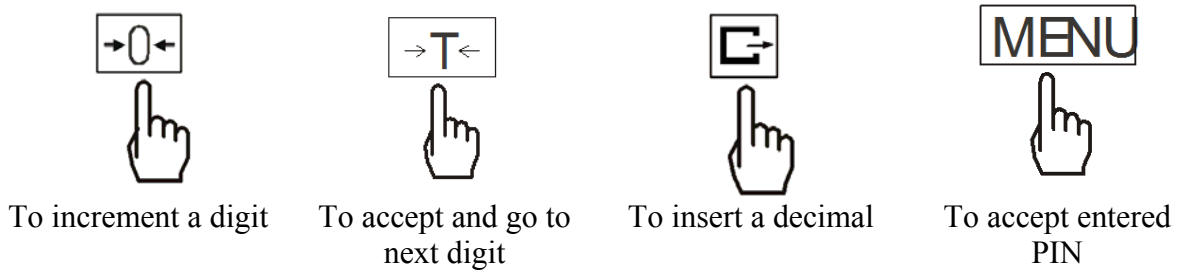

- After setting the PIN, you will be asked to key in the pin in order to access the “Date and Time” feature. To remove or disable PIN access, enter the “Date” function and key-in the current PIN. After accessing the “Date” menu, select option “DatPin” and do not enter a new PIN number. Simply press the MENU key with the dashed line displayed.

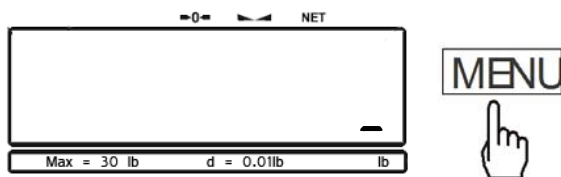

Chapter 23: Threshold Check Weighing and Opto-Isolator (thr)

Threshold check weighing is used to check whether a weight of an object falls within specified threshold limits.

Function Options:

- Thr Off (thrOFF) Disables threshold and check weighing.
- Thr On (thr ON) Enables threshold weighing and sets function parameters.
- Thr Prn (thrPrn) Prints currently set parameters.
- Dat Cfg (thrCFG) Sets output mode for the opto-isolator (Pulse Mode / Level Mode).

23.1. Enabling check weighing and setting threshold limits.

1. Press the MENU key, when the option “thr” is displayed press the T key, and then select the option “thr On” by press the T key once again.

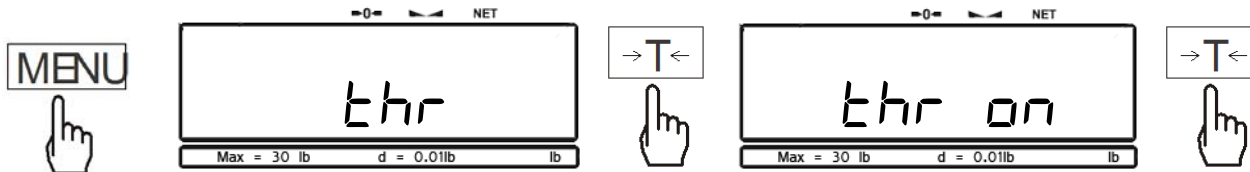

2. The scale will begin to display threshold limits. To set the Lower Limit wait for “Set-1” to display and press the T key. To set the Upper Limit wait for “Set-2” to display and press the T key. To set the minimum weight value that should be used in check weighing select “Set-3”.

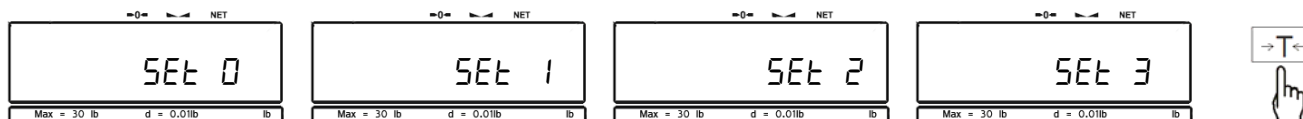

3. The scale will display a dashed line indicating to enter the limit value. To enter the value, use the following keys: the -->0<-- key to increment a digit, the T key to accept and go to the next digit, the  key to insert a decimal, and the MENU key to accept the entire setting.

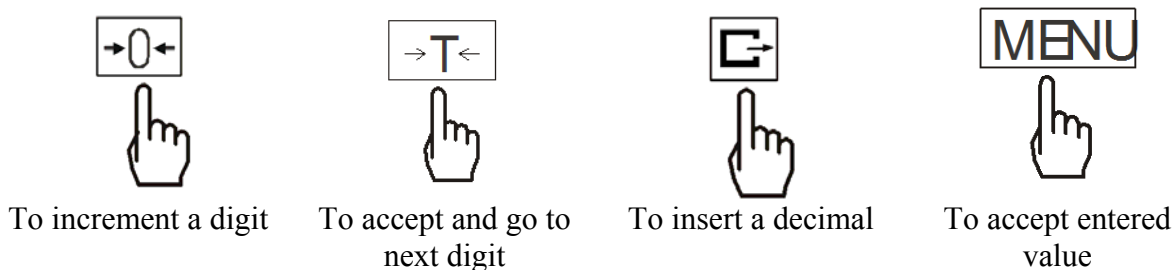

- After setting all limit sets, select “Set-0” in order to return to weighing with the limits enabled.

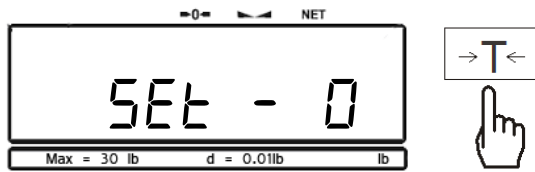

- To perform check weighing places the weigh on the Pan. The result is indicated by a dashed line located on the left side of the display.

LOW	OK	HIGH
<p>The display shows "0.50" with a single horizontal bar on the left side. Above the display are "0" and "NET". Below it, "Max = 30 lb", "d = 0.01lb", and "lb" are visible.</p>	<p>The display shows "1.10" with two horizontal bars on the left side. Above the display are "0" and "NET". Below it, "Max = 30 lb", "d = 0.01lb", and "lb" are visible.</p>	<p>The display shows "3.20" with three horizontal bars on the left side. Above the display are "0" and "NET". Below it, "Max = 30 lb", "d = 0.01lb", and "lb" are visible.</p>

- To disable check weighing enter the “thr” menu and select “thr Off”
- To view the threshold limits press the MENU key, when the option “thr” is displayed press the T key, and then select the option “thrPrn ” by press the T key once again.

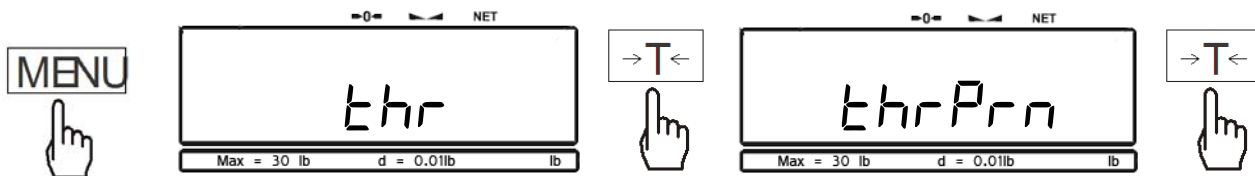

- Current limit sets will be displayed and transmitted via the RS-232 port. To view all limits use the T key.

LOW	HIGH	Min
<p>The display shows "1.00" with a single horizontal bar on the left side. Above the display are "0" and "NET". Below it, "Max = 30 lb", "d = 0.01lb", and "lb" are visible.</p>	<p>The display shows "3.00" with three horizontal bars on the left side. Above the display are "0" and "NET". Below it, "Max = 30 lb", "d = 0.01lb", and "lb" are visible.</p>	<p>The display shows "0.20" with no bars on the left side. Above the display are "0" and "NET". Below it, "Max = 30 lb", "d = 0.01lb", and "lb" are visible.</p>

23.2. Setting the output mode for the opto-isolator (Pulse Mode / Level Mode).

Output signals are provided for controlling sorting or signaling equipment:

- Voltage level output signals Under, OK, and Over -Signal Mode
- Pulse output signals greater than level I, greater than level II, and below the function activation level III – Pulse mode

Signal Mode:

P1 high indicates the level III (min weight) has been passed, P2 high indicates that weight is greater than level I, P3 high indicates that the weight is greater level II. No signal indicated that the weight is less than min. required to activate, P1 alone =LOW, P1 and P2 without P3 = OK, P1 and P2 and P3 = HIGH.

Pulse Mode:

P1 pulse indicates that the level I threshold has been passed, P2 pulse indicates that the level II threshold has been passed, P3 pulse indicates that the min weight level has been passed. P3 alone = LOW, P3 and P1 = GOOD, P3 and P1 and P2 = HIGH.

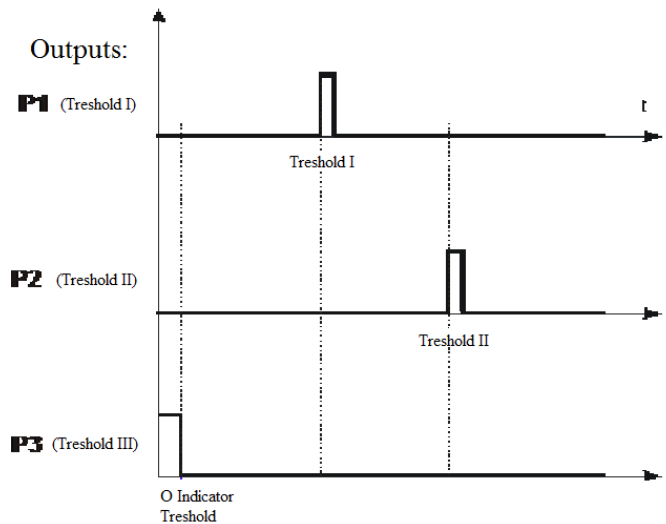
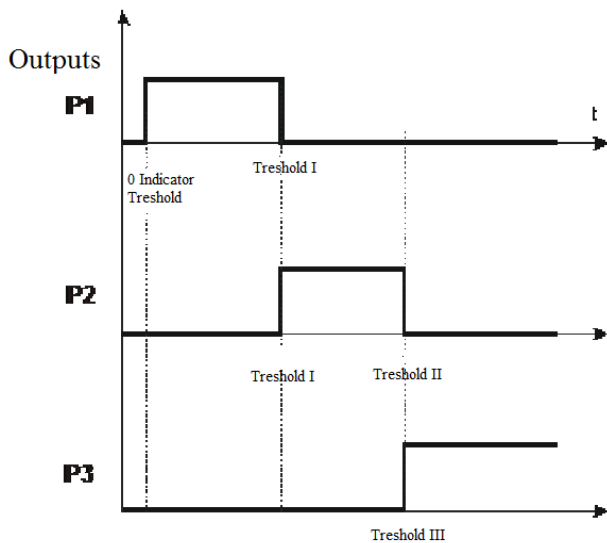

The Pulse outputs are open collector switches to ground for approximately 0.5 second. The P3 output indicates that the minimum weight required to initiate the check weighing function has been passed. The P1 and P2 pulses will not appear unless P3 occurs.

1. To select an output mode, press the MENU key, when the option “thr” is displayed press the T key, and then select the option “Thr Cfg” by press the T key once again.

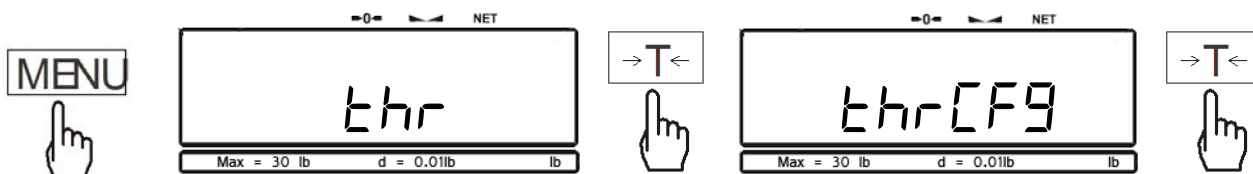

- The scale will display options “Impuls” and” Signal”. To select Pulse Mode press the T key when “Impuls” is displayed, to select Signal Mode press the T key when “Signal” is displayed.

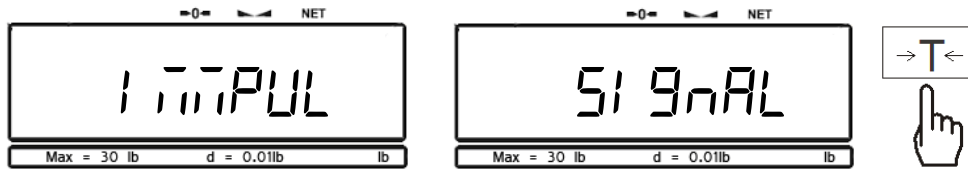

23.3. Opto-isolator Output

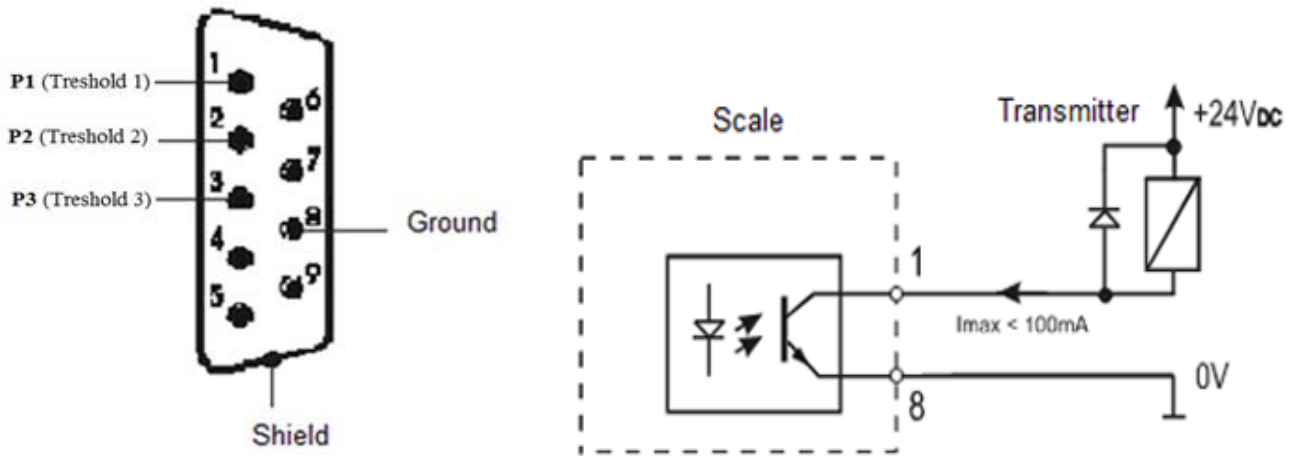

The outputs are open collector optically isolated switches. Each output has a current rating of 100.ma and an open circuit collector voltage rating of 24 VDC. If the outputs are used to drive relays each relay should have a flyback diode, with at least a 100.ma rating, to protect the drive transistor. If relays are used as buffers to the sorting equipment be sure the contacts have adequate ratings and are properly protected from inductive loads.

Chapter 24: Totalizing (tOtAL)

Function Options:

- Tot Prn (tOtPrn) Displays and prints transaction total. (Does not reset the sum value)
- Tot Off (tOtOFF) Displays and disables the transaction total. (Resets the sum Value)
- Tot o (tOt o) Prints measurement weigh before adding.
- Tot - (tOt -) Adds measurement weigh to the total without printing

24.1. Performing Totalizing.

Storing a Tare Value Automatically

1. Place a container on the pan and press the T key to tare.

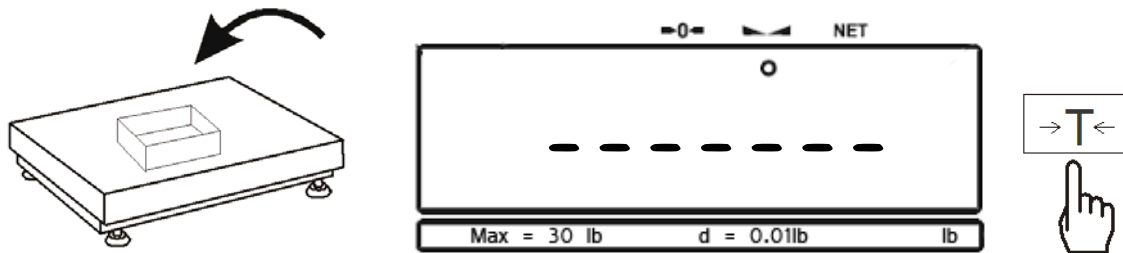

2. Press the MENU key, when the option “Total” is displayed press the T key, and then select the option “Tot o ” or “Tot –“ by press the T key once again.

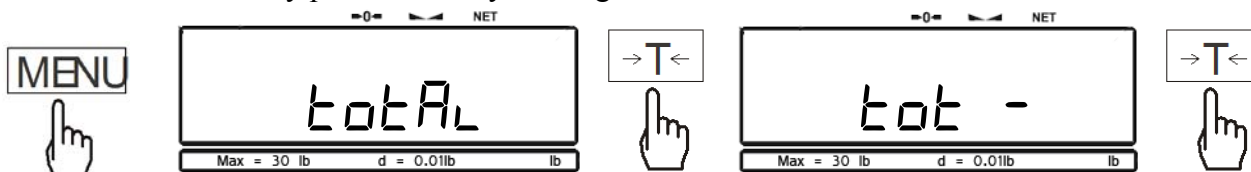

3. The display will read 0 indicating that you may place the first object into the container. Once the Weight of the object stabilized press the data transfer key  to accept and add the object weight to the total.

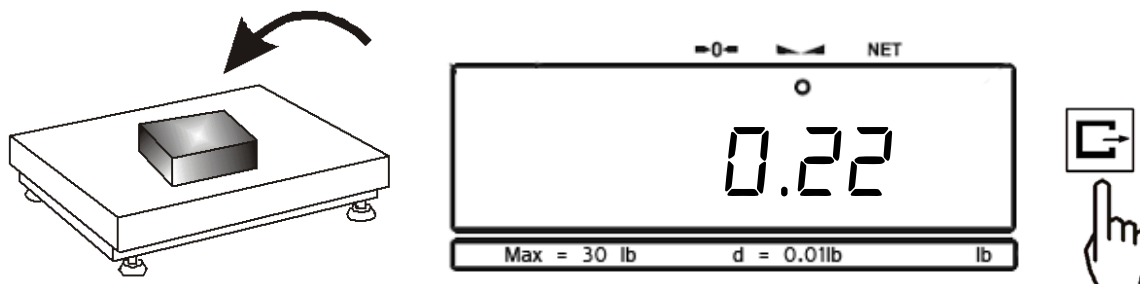

- Once the weight has been added, remove the object from the weighing pan.

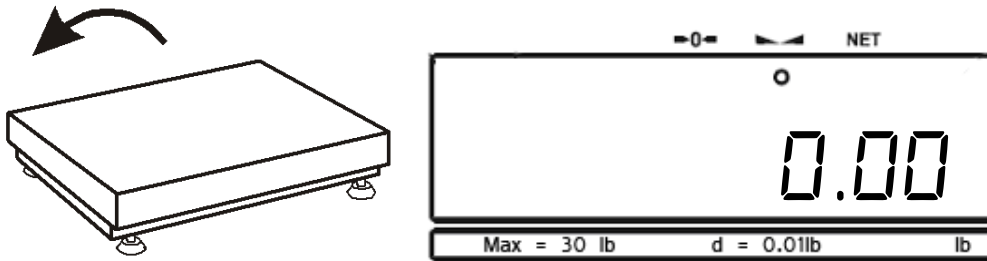

- Wait for the scale to return to 0 and place the second object on the pan. . Once the Weight of the object stabilized press the data transfer key  to accept and add the second object weight to the total.

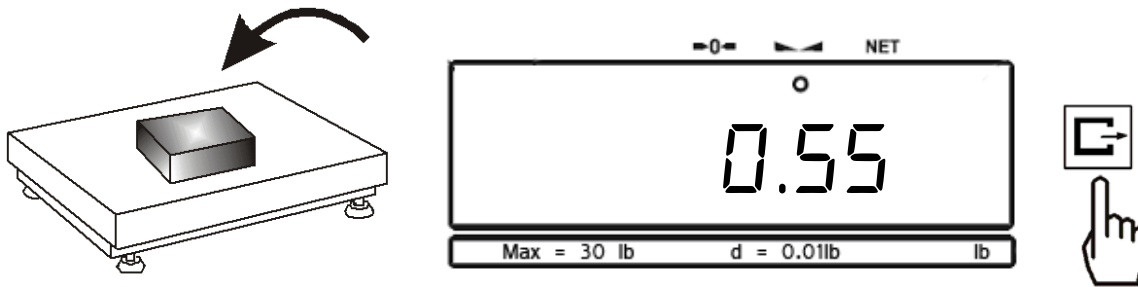

- Follow steps 3 through 6 until all object have been added. To view the total of the transaction press the Toggle key and the Total screen will appear, press the TOGGLE key again and the N7umber of Measurements screen will appear, press the TOGGLE key again and the Transaction Average screen will appear.

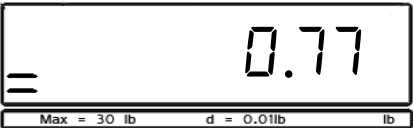
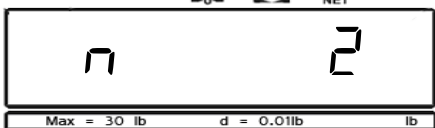
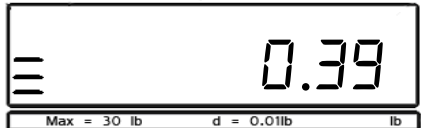
Total	Number of measurements	Transaction Average
 <p>The display shows '0.77' in large digits. Above the display are the symbols '0', 'NET', and 'lb'. Below the display, it reads 'Max = 30 lb' and 'd = 0.01lb'.</p>	 <p>The display shows 'n 2' in large digits. Above the display are the symbols '0', 'NET', and 'lb'. Below the display, it reads 'Max = 30 lb' and 'd = 0.01lb'.</p>	 <p>The display shows '0.39' in large digits. Above the display are the symbols '0', 'NET', and 'lb'. Below the display, it reads 'Max = 30 lb' and 'd = 0.01lb'.</p>

- Press the TOGGLE again and a screen saying “totEnd” will appear, press the TOGGLE key again and the scale returns to the weighing mode without clearing the parameters and allows the user to continue the totalizing process. If the TARE key is pressed instead of the TOGGLE key the screen alternates between YES and NO. If the TARE key is press while YES is displayed the stored ingredient weights are cleared but the unit remains in the Total mode. If the TARE is pressed while NO is displayed the stored ingredient vales are retained and the scale remains in the Total mode.

Chapter 25: Changing to Grams (g) or Pounds (lbs) (Lb_bAL)

The function “lb bal” is used to configure the unit to weigh in grams (g) or pounds (lb). “Lb Bal” optimize the scale’s accuracy and resolution disabling or enabling pounds (lb) as a default unit of measure.

1. To disable lb (pounds) as default unit of measure and set the scale weigh in grams (g) .Press the MENU key, when the option “lb_bal” is displayed press the T key.

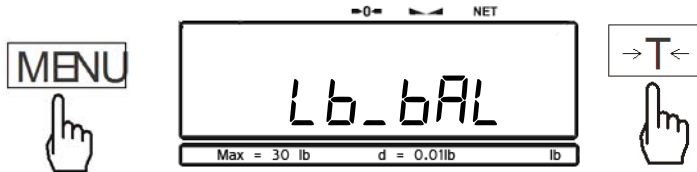

2. The scale will display options “Lb Off” and” Lb On”. To select disables pounds and select grams as the default unit of measure press the T key when “Lb Off” is displayed, to disables grams and select pounds and the default unit of measure press the T key when “Lb Ob” is displayed.

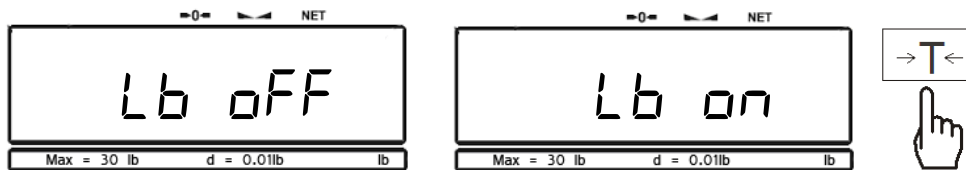

Chapter 26: Menu Customization (ACTIU)

The Active function is used to customize the scale's Main Menu. This feature should be used to deactivate functions or features that are not used. Deactivated functions will not appear in the Main Menu which will simplify its use. To activate or deactivate features or function follow the steps below.

1. Press the MENU key, when the option "Active" is displayed press the T key, and then select a desired function or feature by press the T key once again when the name is displayed.

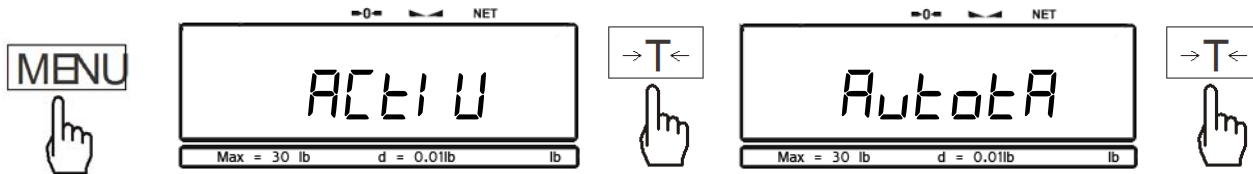

2. The scale will display options "ON" and "OFF". To disable a function from appearing in the Main Menu press the T key when "Off" is displayed, to enable a function to have it appear in the Main Menu press the T key when "On" is displayed.

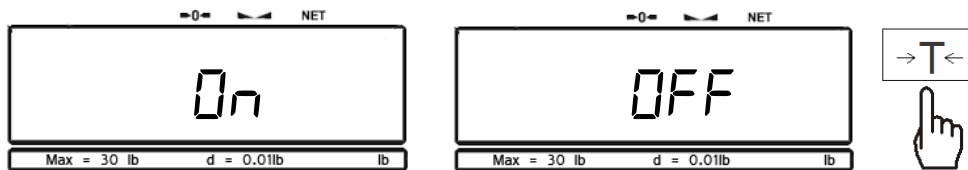

Chapter 27: Resorting Default Settings (dEFAULT)

To restore the scale's factory settings follow the steps below

1. Press the MENU key, when the option "Default" is displayed press the T key.

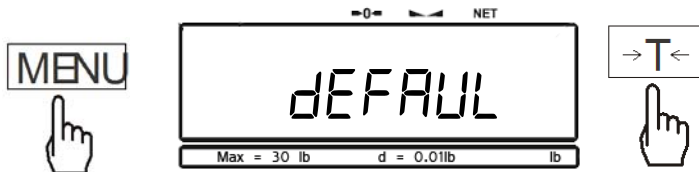

2. The scale will display options "Yes" and "No". To restore the scale's factory setting press the T key when "Yes" is displayed. To cancel press the T key when "No" is displayed.

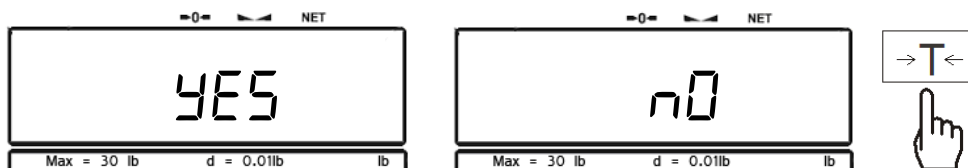

Chapter 28: Common Errors and Troubleshooting

Error or Indicator	Cause	Explanation / Solution
- - - -	Below zero	Re-zero the scale by pressing the →0← key.
- -	Taring is not allowed	Place a weight on the pan before taking a tare.
- -	Re-zeroing is not allowed	Remove weight from pan and clear stored tare values.
L	Pan error	Make sure that pan is properly seated on the pan support.
H	Exceeded capacity	The scale has exceeded its weighing capacity. Reduce the weight.
Err - b	Pan not cleared on power-up	The pan was not empty while the scale was initiating at startup. Clear the pan and restart the scale.
<i>Sapl LO</i> (Parts Counting)	Average piece weight is too low	The average piece weight is lower than 3e. Be sure that individual piece weight is greater than 3e.
<i>Sapl LO</i> (Percent Weighing)	Sample reference weight is too low	The sample reference weight is lower than 100d. Increase the sample weight.
The scale will not turn on	Possible power failure	Check the power AC adapter connection.
Weighing results are not accurate	Inaccurate calibration	Calibrate the scale.
Weighing result will not stabilize	Irregular environment	Eliminate drafts or vibrations.

Chapter 29: Maintenance

Cleaning and maintaining your Scale:

- Do not use chemicals or benzene when cleaning the surface. Corrosive chemicals may damage the finish.
- Alcohol may be used only to clean the scale's stainless steel surfaces.

Chapter 30: Limited Warranty

PURCHASER'S 12-MONTH WARRANTY

Warranty is valid only if the attached warranty registration card is completed and returned within 30 days.

This product is a precision device made to exacting standards of scientific accuracy. It is guaranteed to have been adjusted and inspected for proper workmanship and performance, and certified for its currently advertised specifications before shipment.

Fulcrum Products are warranted against defects in material and workmanship under normal use and service. This warranty is extended only to the first purchaser. This limited warranty will not apply if, upon inspection, it is found that the product was tampered with, misused, overloaded, or abused, mishandled, placed in an improper environment, improperly installed or adjusted, used for a purpose other than that for which it was designed, or repaired by unauthorized personnel.

Fulcrum's liability under this warranty is limited to furnishing labor and parts necessary to remedy the defect covered by this warranty and restore the product to normal operating condition. Purchasers may be charged a minimum repair fee for in-warranty products returned for repair if those products are determined to be problem-free.

To make a claim under this limited warranty, obtain an RMA number from Fulcrum and return the product, carefully packed in its original packaging, shipping prepaid, with the RMA number written on the return package.