

# TABLE OF CONTENTS

1. Cautionary Notes and Precautions
  - 1.1. Important Safety Warnings**
  - 1.2. HOT Parts and Surfaces**
  - 1.3. More Cautionary Notes and Precautions**
2. Specifications
3. Introduction
  - 3.1. Function of the Moisture Analyzer
  - 3.2. Good Practices and General Rules
4. Keys, Display Indicators, Commands, and Abbreviations
5. Parts Description
6. Unpacking the Moisture Analyzer and Getting Started
7. Understanding the Functions, Parameters, and Modes
  - 7.1. Methods of Terminating the Moisture Analysis
  - 7.2. Understating Configuration Parameters
8. Configuration and Parameter Setting for Moisture Analysis
  - 8.1. Mode
  - 8.2. Calculation Formula
  - 8.3. Drying Temperature
  - 8.4. Sample Quantity
  - 8.5. Sampling Interval
  - 8.6. Drying Time
  - 8.7. Saving the Configuration and Parameters
9. RAP Configuration
10. Preparing the Sample
  - 10.1. Using a Glass Fibre Filter
11. Making a Moisture Analysis
12. Setting Drying Parameters for Unknown Samples
13. Loading Saved Parameters and Configuration
14. Report Printing
15. Testing the Analyzer with Sodium Tartrate Dihydrate
16. Weighing
  - 16.1. Taring
  - 16.2. Clearing the Tare
17. Parts Counting
  - 17.1. Using a Custom Sample Size
  - 17.2. Counting Based on a Known Individual Piece Weight
18. Calibration
19. Main Menu
  - 19.1. Autotaring
  - 19.2. RS232 Serial Port Configuration
  - 19.3. Print Adjustment
  - 19.4. Time and Date
  - 19.5. Language
  - 19.6. LCD Setting
20. Halogen Replacement and Maintenance of the Moisture Analyzer
21. Technical Information
22. Common Errors and Troubleshooting
23. Replacement Parts
24. Limited Warranty

## Chapter 1: Cautionary Notes

The TORBAL Moisture Analyzer is a sensitive and a delicate instrument that generates heat up to 160°C. Many parts and surfaces of the moisture analyzer get extremely HOT. Always handle the analyzer with care and use EXCESSIVE CAUTION when operating the moisture analyzer.

### 1.1. Important Safety Warnings

#### WARNING:

- Do not test flammables, explosives, or things that produce dangerous or noxious vapors.
- Do not test unknown substances.
- Do not put anything on the perforated top cover of the unit.
- Do not pass anything over the top of the unit when drying is in progress. Never pass fluids over the perforated cover (a spill can be disastrous).
- If a sample flames, first pull the power plug from the power outlet, then extinguish the flame.
- Always assume the Drying Chamber is hot when you open the cover. As the internal parts can retain heat, allow adequate time for cooling before touching any of the internal surfaces.
- Never touch a halogen lamp unless you are about to replace it, and you are sure it is both off and cool.



**WARNING:**

- If a mistake creates a dangerous situation, hit the **STOP** key and it will terminate the heating immediately.
- Use caution when touching any of the parts that rise to high temperatures during testing. Wear protective gloves when removing hot samples, even when using the pan handle (it can get very hot).
- Use the cover handle to open and close the Drying Chamber.
- Always use forceps or needle-nose pliers to remove the hot disposable sample pan from the larger permanent pan.
- When loading a new sample into the Drying Chamber using the pan handle, make sure the disposable sample pan and sample are centered and that the sample has been leveled. The maximum sample height must be less than 10 mm.
- Be sure the Analyzer is in an area with good air circulation (to diffuse the heat generated by the Drying Chamber), relatively low (less than 85%) or controlled humidity (for accurate measurements), and an ambient temperature between 18°C and 30°C.

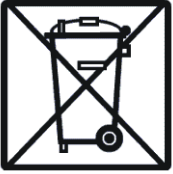
	Legal regulations forbid disposal of electronic equipment in waste containers.
<ul style="list-style-type: none"><li>• Please return this device to the point of purchase or another company that specializes in recycling of waste electronic components.</li></ul>	

## 1.2. HOT Parts and Surfaces

Many parts of the Moisture Analyzer get very HOT during use. Familiarize yourself with these internal parts and always allow adequate time for cooling before touching or handling.

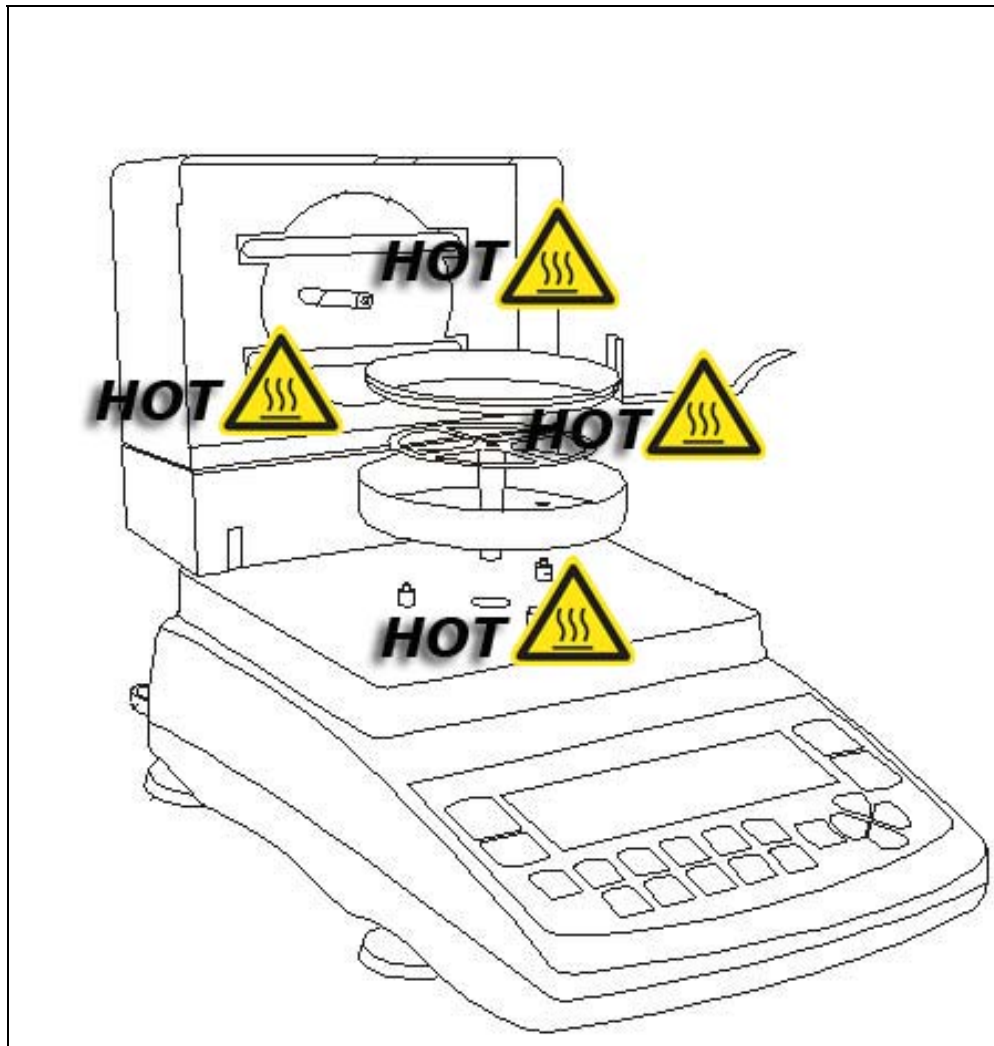

### 1.3. More Cautionary Notes and Precautions

Correct location and proper environment has a significant impact on the accuracy of the weighing results of the TORBAL Moisture Analyzer.

#### The optimal location for your unit:

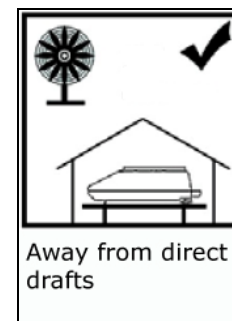
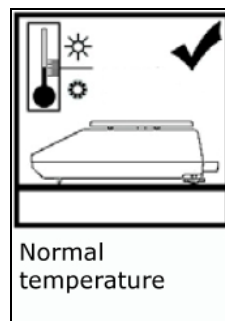
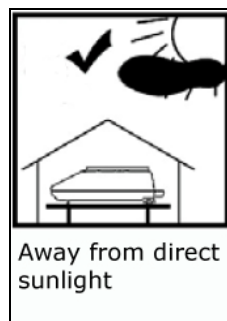

- Stable, vibration-free base as horizontal as possible
- Away from direct sunlight
- Not exposed to high temperature variations
- Away from direct drafts
- Best location: stable bench away from direct drafts, doors, windows, radiators, and air conditioner vents.

#### CAUTION:



- The Analyzer is designed for indoor use only.
- Do not operate the unit in hazardous areas or conditions.
- Do not use the Analyzer in locations subject to high humidity or dust levels.
- Do not connect cables in ways other than those designated in this manual.
- Be sure to set the Analyzer on a firm, stable horizontal surface.
- Never stand on or lean on this product. Equipment may fall or collapse, causing breakage and possible injury.
- Before moving the product, unplug it and unplug all cables connected to it.
- When storing, transporting, or returning the unit for service, always use the original packaging.

#### WARNING:



- Never attempt to repair, disassemble, or modify the Analyzer yourself. Tampering with the unit may result in injury and cause more damage to the equipment.
- Be sure to use the specified power source.
- Do not allow foreign matter to fall into the unit.
- If water or other liquid spills into the Analyzer, do not continue to use it. Unplug the power cord immediately and contact technical support.

## Chapter 2: Specifications

	Model	
	AGCN100	AGCN200
Maximum Capacity	50g	100g
Readability (d)	0.001g	
Repeatability (Standard Deviation)	0.001g	
Linearity	+/- 0.002g	
Tare Range	-50g	-100g
Accuracy Class	II	
Calibration Weight	50g	100g
Operating Temperature	+18C to +33C	
Analyzer Resolution	0.01%	
Moisture Measurement Accuracy	0.1g to 5g = +/-0.3% 5g to 15g = +/-0.06% > 15g = < +/-0.04%	
Maximum Drying Temperature	160°C	
Sampling Time	1 sec. to 180 sec.	
Maximum Drying Time	10 hours	
Drying Power	250W	
Halogen Size	118mm	
Warm-up time	Approximately 30 sec.	
Pan Size	90mm	
Drying Chamber Dimensions	108mm x 20mm	
Scale Dimensions	215mm x 345mm x 200mm	
Unit Weight	7kg	
Power	110VAC, 60Hz	
Warranty	12 months	

## Chapter 3: Introduction

### 3.1. Function of the Moisture Analyzer

- The primary function of the device is to make precise measurements that allow the user to determine the moisture content of various materials using the principle of thermo-gravimetric analysis.
- The secondary functions is to use the device as a precision scale to make weight determinations, as well as to use the combination of computer software and the weighing function to count parts.

### 3.2. Good Practices and General Rules

- Larger samples take longer to dry, but produce more accurate results. When accurate results are required, try to stay in the 5 to 15 gram range. Use the Drying Chart feature to help in optimizing the Sample Size, Drying Time, and Temperature.
- For uniformity of results, it is better to set the Drying Time for a little longer rather than shorter.
- Lower temperatures take longer, but produce more uniform results in many materials. This is especially true if thermal decomposition is encountered in which added moisture is driven off as drying continues because of decomposition.
- Prepare the sample properly. This includes: obtaining uniformity of initial weight, leveling the sample, using a glass fiber disc with fluid samples or samples that produce fluids when heated, and avoiding carbonization of the sample when possible (lower heat helps).
- Prepare the sample quickly and get it into analysis before its moisture content is altered by its surroundings.
- The more samples tested, the better the statistical reliability of the results.
- If solvents are required, be very careful of the vapors produced—they can be flammable or even explosive. Safety first!
- Keep the Analyzer clean, keep the area around the Analyzer clear, calibrate the weighing unit periodically, and test the unit for moisture accuracy using the Sodium Tartrate Dihydrate chemical standard whenever problems are suspected (or periodically).
- Above all, remember the Drying Chamber can run at high temperatures, so use caution whenever opening the cover or handling sample pans. The internal surfaces retain heat for some time.

## Chapter 4: Keys, Display Indicators, Commands, and Abbreviations

Key	Primary Function	Secondary Function
I/Ø	Power On and Power Off	-
←→T	Tare – used to tare the weighing pan	N/A
→0←	N/A	N/A
ENTER →	Enter – used to accept and confirm commands	N/A
MENU	Menu – used to access the main menu	Number “9” key
CLR	Clear – used to clear and cancel operation	N/A
<> ^	Navigation Keys – used to navigate through the menus	N/A
← →	Mode Return – used to switch between moisture analysis and weighing modes	Number “0” key
[→	Data Transfer – used to print data to a printer or transfer data to a PC via the RS232 communication port	Number “7” key
▼	N/A	Number “8” key
F1	START	Number “1” key
F2	SET	Number “2” key
F3	STAT	Number “3” key
F4	MEM	Number “4” key
F5	STOP	Number “5” key
Display Indicator	Description	
T	The current temperature in the drying chamber	
m	Current weight	
t	Current drying time	
m0	Initial weight	
Ts	Defined drying temperature	
ts	Defined drying time	
AUT	Autotaring	
Command or Abbreviation	Description	
Drying temp.	Drying Temperature	
Sampling Interv.	Sampling Interval	
Meas Number	Measurement Number	



**Chapter 5: Parts Description**

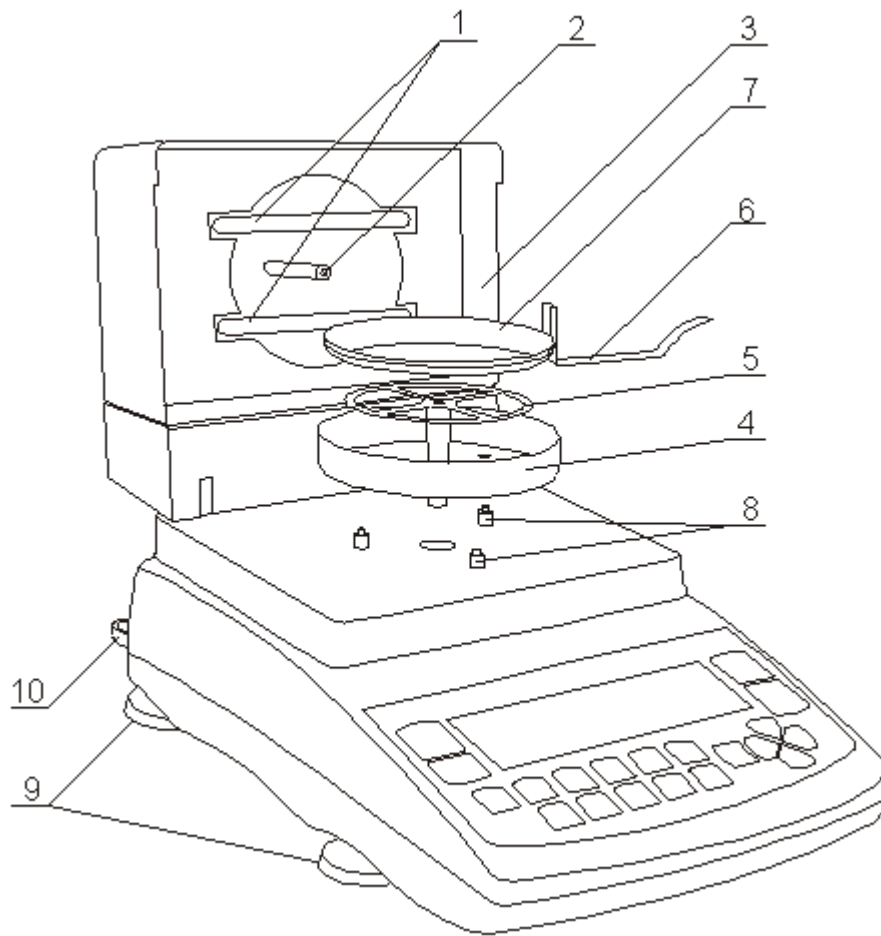

<i>Part No.</i>	<i>Description:</i>
<b>1</b>	Halogen Lamps
<b>2</b>	Temperature Sensor
<b>3</b>	Drying Chamber
<b>4</b>	Pan Shield
<b>5</b>	Pan Support
<b>6</b>	Pan Handle
<b>7</b>	Disposable Pan
<b>8</b>	Pan Shield Posts
<b>9</b>	Adjustable Legs
<b>10</b>	Level Indicator

## Chapter 6: Unpacking the Moisture Analyzer and Getting Started

1. Carefully remove the Moisture Analyzer and all its components from the packaging and place them on a stable base where the unit will not be affected by any mechanical vibrations or air movements.
2. After removing the Pan Shield (4), Pan Support (5), and Pan Handle (6) from their packaging, open the Drying Chamber (3) and carefully install the Pan Shield (4) on the three Pan Shield Posts (8).
3. Once the Pan Shield is installed on the shield posts, gently insert the Pan Support (5) into the opening of the Analyzer's mechanism.
4. After installing the Pan Support, place a Disposable Pan (7) on the Pan Handle (6), then place it on the Pan Support so that the handle rests on the Pan Shield without touching the Pan Support.
5. After installing all pan components, close the Drying Chamber and level the Analyzer by adjusting the leveling feet until the level indicator shows the "air bubble" is in the center position of the sight glass. The level indicator is located on the rear left side of the unit.
6. After leveling the scale, plug the power supply cable into the power supply socket (Marked 110V) located in the rear of the Analyzer.
7. Make sure the drying chamber is closed, and then plug the power cable into the wall outlet.
8. When the cable is plugged into the wall outlet, the Analyzer will turn "ON" automatically, initialize itself, and perform Initial Heating. The Initial Heating is designed to drive any residual moisture from the heating chamber. The internal temperature is raised to 105°C and held there for a preset time period
9. Upon completion of the power-up sequence, the unit comes up in the Moisture Analyzer Mode and is then ready to be used.



**WARNING: Please be careful and remember the drying chamber has been heated and will retain heat for some time.**

## Chapter 7: Understanding the Functions, Parameters, and Modes

### 7.1. Methods of Terminating the Moisture Analysis

There are 3 methods for terminating a moisture analysis:

1. **Time Mode** - drying is terminated when a set “Drying Time” is reached.
2. **Short Mode** (See graph below) – drying is terminated when the mass loss between successive samples (Sample Quantity) is smaller than the threshold value of 2mg.
3. **Manual** – drying is terminated when F5 STOP is pressed.

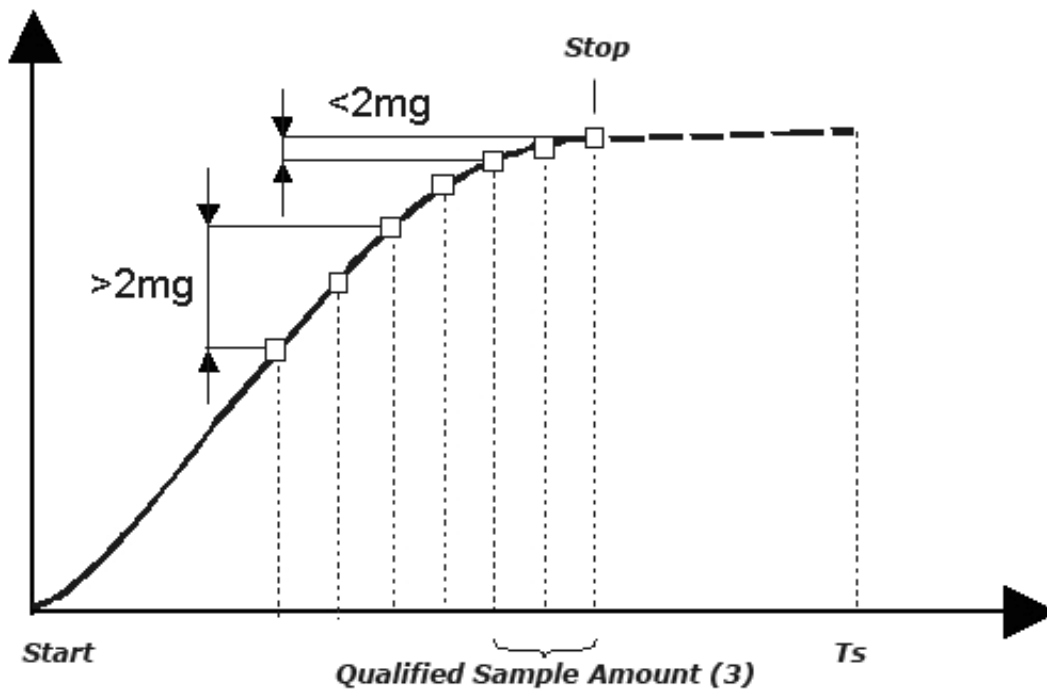

## 7.2. Understanding Configuration Parameters

Mode (Default Setting:  $m_0 - m/m_0 * 100\%$ )

**Three formulas are available for performing moisture analysis:**

1.  $W [\%] = m_0 - m/m_0 * 100\%$ , where moisture is determined in relation to initial weight
2.  $W [\%] = m - m/m * 100\%$ , where moisture is determined in relation to current weight
3.  $W [\%] = m/m_0 * 100\%$ , where current weight is determined as a percentage of sample weight

Where:  $m_0$  = initial (wet) weight,  $m$  = current weight, and  $W [\%]$  = moisture as a %

**Drying Temperature:** This parameter is used to define the maximum drying temperature for a sample. Once the temperature is defined, it will be held constant for the duration of the drying time.

**Sample Quantity:** In the *Short Mode* this parameter is used in conjunction with the *Sampling Interval* parameter to have the analysis terminated when the successive weight measurements (samples) do not differ by more than 2mg. When setting this parameter, the Analyzer will begin to take the set number of samples (*sample quantity*) and compare the weight result of each. When the weight of the samples does not differ by more than 2mg, the analysis will stop. This configuration method is particularly helpful when an adequate *Drying Time* of the sample is uncertain. If the change between samples is less than 2mg, we can assume the sample has been dried and the analysis can be stopped.

**Sampling Interval:** In the *Short Mode* this parameter is used in conjunction with the *Sample Quantity* parameter. It defines the time interval between sampling. The maximum *Sampling Interval* is 180 seconds. This parameter can also be also used in the *Time Mode* for monitoring the moisture loss as well as for statistical functions such as the *Drying Chart*, or to print and record the sample weights. (See Chapter 10. STAT Configuration).

**Rule of Thumb for the Short Mode:** Higher number of samples and longer time intervals result in a more accurate estimate for the total drying time of the sample, as well as the end result.

**Drying Time:** This parameter is used to set the length of the drying in order to complete the analysis in the *Time Mode*. When the Drying Time is reached, the analysis will stop.

# Chapter 8: Configuration and Parameter Setting for Moisture Analysis

1. If the Analyzer is in weighing mode, press the MODE RETURN key and enter the Moisture Analysis Mode.



2. Press the SET (2) key to enter the Moisture Analyzer main menu. Configuration parameters will be displayed: *Mode*, *Drying Temp*, *Samples Quantity*, *Sampling Interval*, *Drying Time*, and *Save Parameters*.

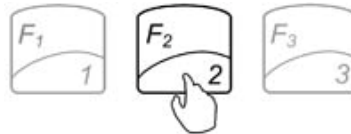

## 8.1. Mode

1. Use the “<math>\diamond</math>” navigation key to select Mode and press the ENTER key.

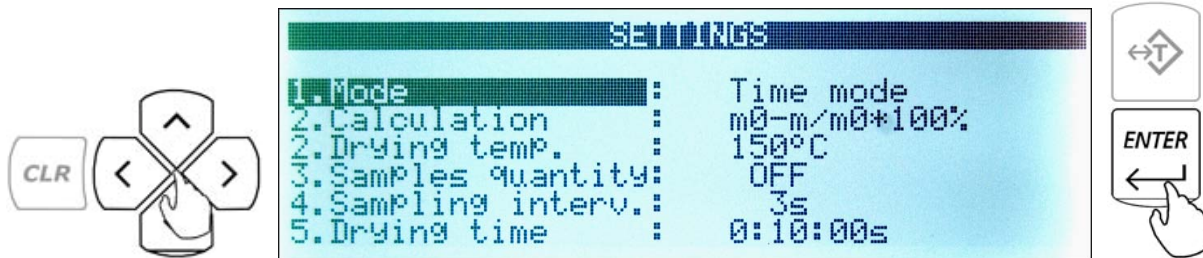

2. The current mode will be displayed. Use the “<math>\diamond</math>” navigation key to alternate between the *Time Mode* and the *Short Mode*. Once a desired mode is displayed, press the ENTER key to confirm the selection.

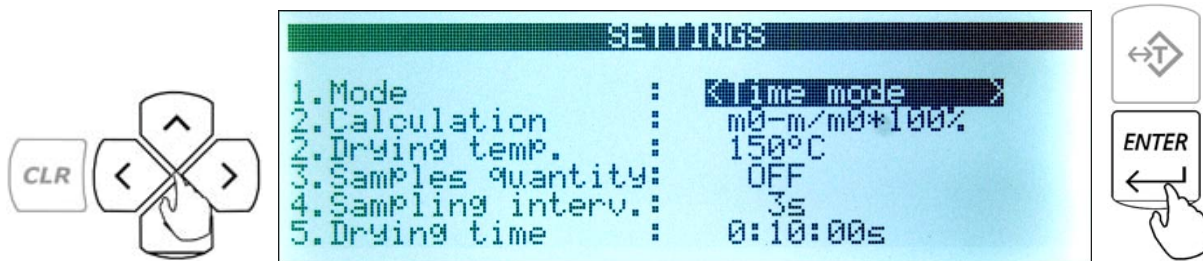

**Short Mode** – the analysis will be terminated automatically when the loss in moisture between the samples taken during the analysis is less than 2mg. This mode requires that the Sample Quantity (Section 8.4) and the Sampling Interval (Section 8.5) are defined.

**Time Mode** – the analysis is terminated when the defined Drying Time (Section 8.6) is reached.

## 8.2. Calculation Formula

1. Use the “ $\diamond$ ” navigation key to select Calculation and press the ENTER key.

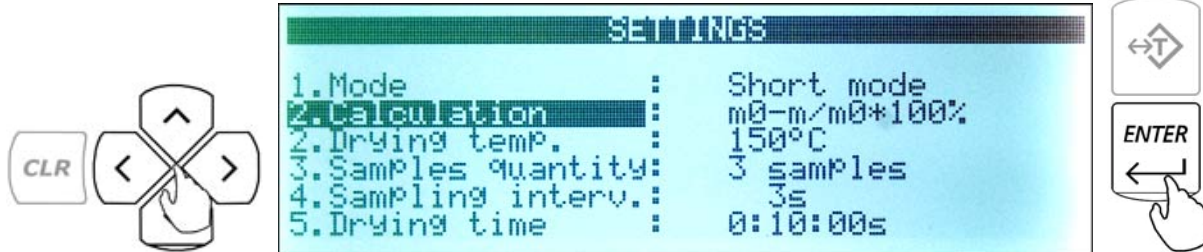

2. The current moisture analysis formula will be displayed. Use the “ $\diamond$ ” navigation key to alternate between formulas. Once a desired formula is displayed, press the ENTER key to confirm the selection.

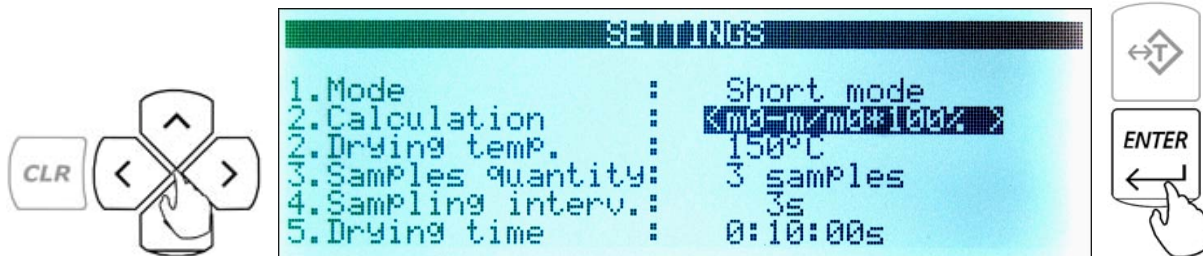

Where  $m_0$  = initial (wet) weight,  $m$  = current weight, and  $W$  [%] = moisture as a %:

1.  $W$  [%] =  $m_0 - m / m_0 * 100\%$ , where moisture is determined in relation to initial weight
2.  $W$  [%] =  $m - m / m * 100\%$ , where moisture is determined in relation to current weight
3.  $W$  [%] =  $m / m_0 * 100\%$ , where current weight is determined as a percentage of sample weight

## 8.3. Drying Temperature

1. Use the “ $\diamond$ ” navigation keys to select Drying Temp and press the ENTER key.

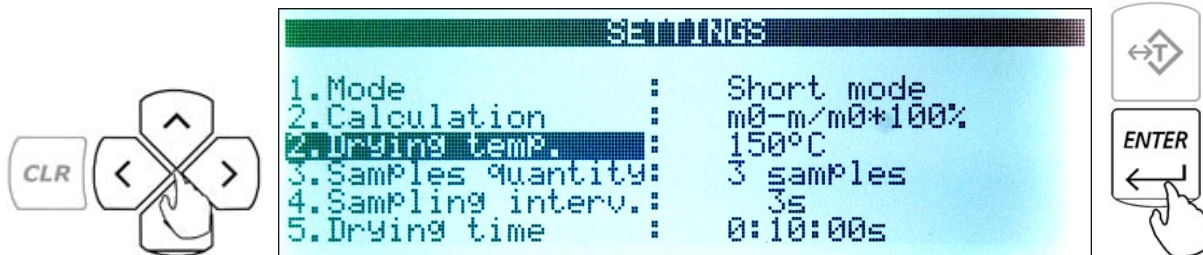

2. Use the Numeric keys to enter the desired Drying Temperature in degrees Celsius. The maximum temperature is 160°C.

- Once the temperature has been entered, press the ENTER key to confirm the selection.

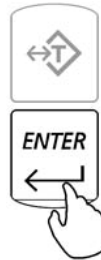

**Note:** A table of materials with their recommended Drying Time and sample weight is included in this manual.

## 8.4. Sample Quantity

**Note:** This parameter must be set when using the analyzer in the Short Mode. See the Notes and Parameter descriptions in Section 7.2.

- Use the “◁▷” navigation key to select *Samples Quantity* and press the ENTER key.

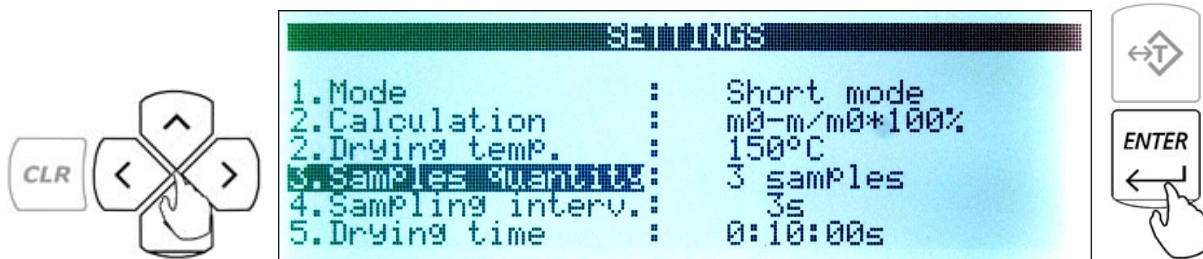

- Use the “◁▷” navigation keys again to select the desired number of samples to be taken. The choices are: *OFF*, *2 samples*, *3 samples*, *4 samples*, and *5 samples*. Once the desired selection has been made, press the ENTER key confirm the selection.

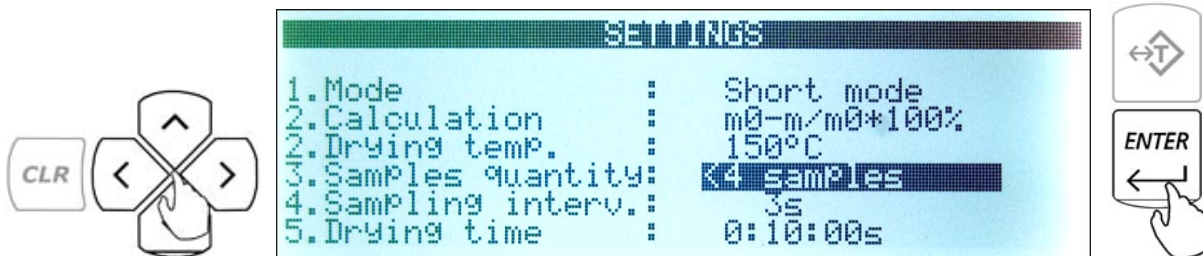

### 8.5. Sampling Interval

1. Use the “◀▶” navigation key to select *Sampling Interval* and press ENTER.



2. Use the numeric keys to enter the desired Sampling Interval in seconds. The maximum time is 180 seconds. Once the desired Time Interval has been entered, press the ENTER key to confirm the entry.



### 8.6. Drying Time

1. Use the “◀▶” navigation key to select Drying Time and press the ENTER key. Drying Time is specified in the following format: hh/mm/ss.

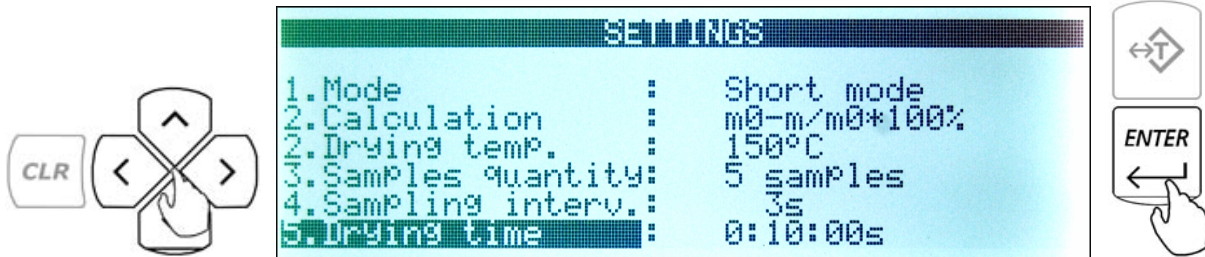

2. Use the numeric keys to enter the desired drying time. Press the ENTER key to advance between fields.



3. Once the desired time has been entered, press the ENTER key to confirm the entry.



### 8.7. Saving the Configuration and Parameters

A configuration of parameters can be saved in the analyzer’s internal memory. Up to 10 different configurations can be saved. To save a configuration for future use, follow the step below:

1. Use the “◁” navigation key to select *Save Parameters* and press the ENTER key.



2. Use the navigation keys to select the memory location in which you want to store the present set of parameters

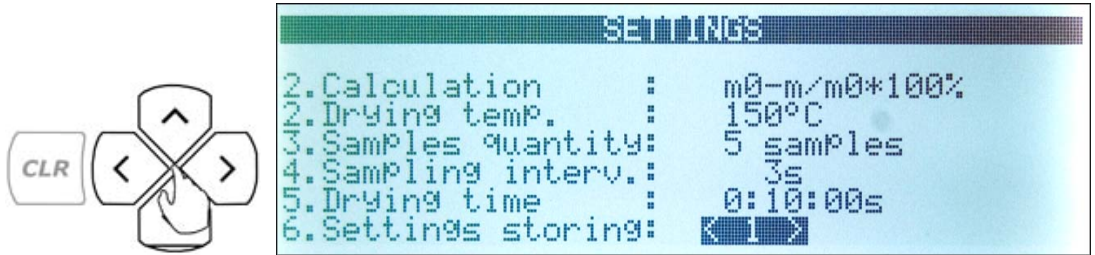

3. Press ENTER to store the parameters in the selected location.

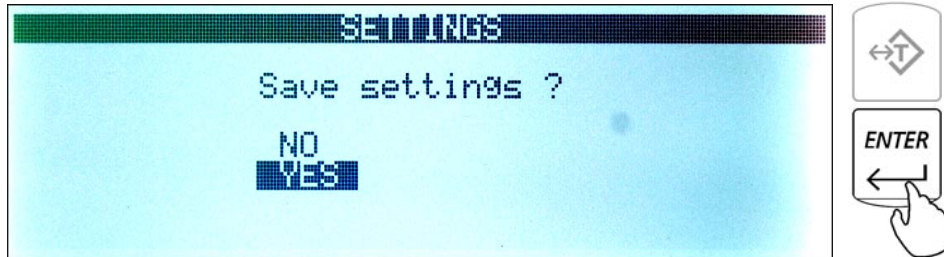

## Chapter 9: RAP Configuration

To enter Statistical Configuration, press the F2 key (STAT). The following STAT options will be displayed:

- **Drying chart** – the Drying Chart is especially useful during initial testing of new materials; however, it should be turned OFF during routine analysis. It is very helpful in defining parameters such as drying temperature, sampling interval, and drying time, as the shape of the drying cycle is clearly displayed.
- **Product name** – this setting allows the User to assign a name of the product or sample being analyzed. The name will be printed on the Drying Report printout (maximum 20 characters total).
- **Executive** – this setting allows the User to assign a name of the person performing the analysis. The name will appear on the Drying Report printout (maximum 20 characters total).
- **Notes** – this setting allows the User to enter important notes that may be required for the analysis. The notes will appear on the Drying Report printout (maximum 240 characters total).
- **Transmission** – when turned ON, this function sends the sample weight to the printer port at the end of each sampling interval. This function can be very useful during initial sample evaluations or for sending data to an external computer for more detailed analysis.

To set and configure the Functions, follow the steps below:

1. Use the Navigation keys to select a STAT function you would like to configure.

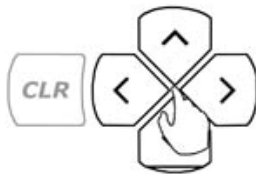

2. Once the function is selected, press the ENTER key.



- For the Drying Chart and Statistics parameters, use the navigation keys to toggle between ON and OFF. Once the function has been enabled or disabled, press the ENTER key to save and confirm the selection.



- For Product Name, Executive, and Notes parameters, it is recommended you use an external keyboard which can be connected to the PS2 keyboard port located in the rear of the Analyzer. Once the data has been entered, select Exit and press the Enter key to save the data and return to the analysis mode.

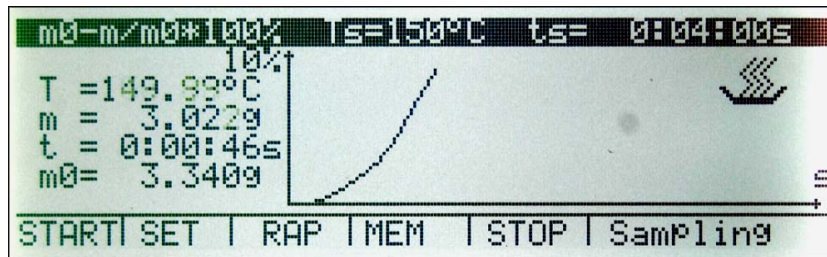

## Chapter 10: Preparing the Sample

1. A sample of a given substance must be representative. Drawing and preparing a sample is a very important process as it may affect the repeatability of measurements. The most common method of homogenizing a sample is mixing. Another method is to draw a few samples from different but specific points in a substance and calculate an average value, or to draw a few samples from different points in a substance, mix them, and draw a sample from the mixture.

**Note:** The sampling method depends on the type of research being performed. In quality control, usually many representative samples are analyzed. In production control, it is enough to confirm sampling repeatability.

2. When preparing a sample, it is important the sample does not absorb moisture from the surrounding environment – thus preparation time should be as short as possible.

**Note:** If it is necessary to analyze more than one sample at the same time, the samples should be placed in separate hermetically sealed plastic bags or containers. Make sure the sample does not lose moisture while it is inside the container (the container or plastic bag should not have much air in it).

3. Tools and instruments used in the preparation process may affect measurement accuracy. Do not use tools that transmit heat as this can cause the sample to lose moisture before the actual analysis. Use only special grinders and mixing instruments. When drawing a sample from a liquid consisting of solid materials, use a glass mixer, spoon, or magnetic mixer.
4. To analyze moisture content, place the sample on the disposable pan provided with the unit and place it in the dryer chamber. Using disposable pans helps to avoid the false results that may be caused by the residue left from previous samples.
5. A sample should be always thin and distributed uniformly throughout the pan so that the heat penetrates equally all over the sample and dries the entire sample effectively.

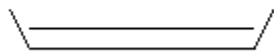

**Correct**

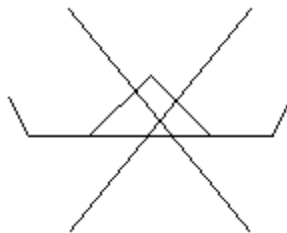

**Incorrect**

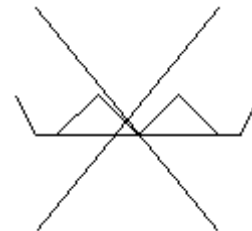

**Incorrect**

**Important NOTE:**

Due to the location of the temperature sensor, the sample height may **NOT exceed 10mm**.

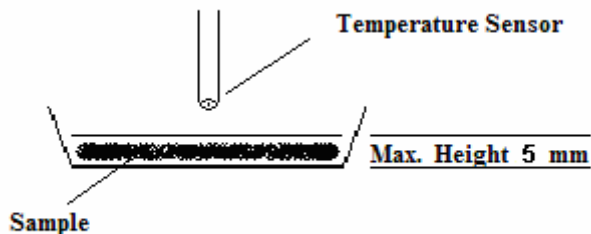

A sample that is thick or unevenly distributed will cause the top surface of the sample to be overly dried and possibly burned while the sample underneath the top surface remains wet. This may result in the sample being burned or the top surface hardening which will make the analysis more difficult as well as inaccurate.

A sample should always be placed in uniform layers measuring 2 to 5mm in thickness and weighing 5 to 15g, depending on the substance.

**Using a Glass Fibre Filter**

When drying liquids, pastes, or substances that may melt or lose liquid during the drying process, the use of glass fibre filters is recommended as filters ensure equal liquid distribution. When solid materials are being dried, a glass fibre filter will prevent the sample from burning.

## Chapter 11: Making a Moisture Analysis

After configuring all of the necessary parameter and preparing the sample, you may begin your moisture analysis by following the steps below:

1. Open the Drying Chamber.



2. Using the Pan Handle, place the Disposable Pan on the Pan Support.



**Note:** Be sure the Pan Handle is not touching the Pan Shield.

3. Press the T key to Tare the Disposable Pan.



- Place the sample on the Disposable Pan. After the Tare has been performed, the Disposable Pan can be removed from the Pan Support by using the Pan Handle to evenly distribute the sample.



**Note:** Make sure the sample is evenly distributed on the Disposable Pan as per the instructions listed in Chapter 11.

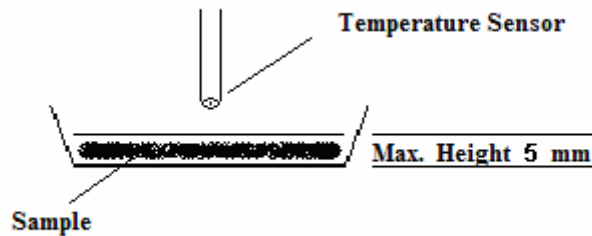

- Close the Drying Chamber.
- Press the F1 (START) key. The unit will indicate on the display that Heating is in progress. The moisture content of the sample will be displayed as a percentage (%). During the analysis, in addition to the result, the display will indicate the Drying Chamber Temperature, the present weight of the sample, the elapsed time, and the initial weight of the sample.





**Important Caution Note:** Do not touch the top surfaces of the Moisture Analyzer’s Drying Chamber or any internal parts either during or soon after use. As the parts and surfaces will be very HOT, allow adequate time for the unit to cool. Be sure to read and follow all Caution Procedures listed in Chapter 1.

7. When the analysis is finished, “END” will be displayed in the lower right corner of the LCD. The Final result will remain displayed. To clear the result and prepare the unit for the next analysis, press the F5 key STOP.



**Caution:** Always use the forceps supplied with the unit when handling a used Disposable Pan.

**Important Note:** Before starting a new analysis press F5 (STOP), replace the disposable pan and perform a TARE to make sure parameters m, t and m0 are cleared (set to 0).



## Chapter 12: Setting Drying Parameters for Unknown Samples

To estimate the optimum drying parameters for an unknown sample, it is recommended you activate the Drying Chart for the initial analysis. To enable the Drying Chart, follow the steps listed in Chapter 10.

After enabling the Drying Chart, set the following parameter values for the initial analysis:

**Temperature:** organic matters: 80 – 100°C, mineral matters: 140 – 160°C

**Qualifying quantity:** None (drying process is stopped after defined drying time)

**Sampling interval:** 1 second

**Drying time:** Set the time value long enough to dry the entire sample

By observing the progress of the drying chart, it is possible to estimate its course and determine the time needed to dry the sample as well as analyze its moisture content.

The X axis of the chart represents 160 time intervals (for longer time intervals, the axis changes to 360, 720, etc.).

The Y axis of the chart represents moisture values according to the chosen formula. It starts at 10% and shifts automatically to 30%, 50%, etc.

**NOTE:** Remember to disable the Drying Chart before regular analysis.

The sample is dried when the slope of the drying chart begins to curve. The actual drying time should be defined with a reserve, taking into consideration differences in the weight of successive samples. If the drying time is too short, the results of moisture analysis will be inaccurate.

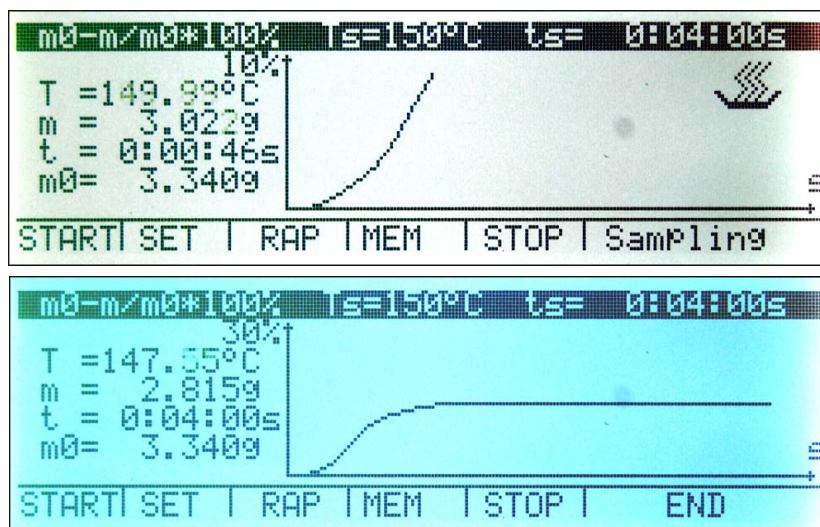

## Chapter 13: Loading Saved Parameters and Configuration

To load saved parameters that have been stored in the memory, follow the steps below:

1. Press the F4 (MEM) key to access the unit's Memory Bank.

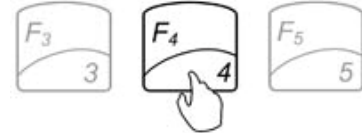
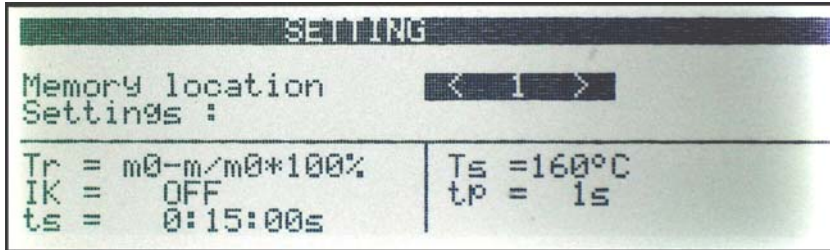

2. Use the navigation keys to select a desired set of stored parameters.

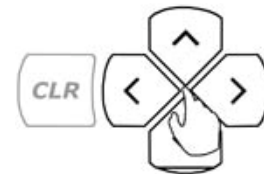
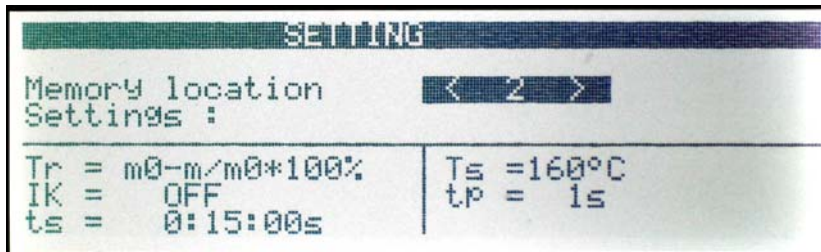

3. Once the set has been selected, press the ENTER key.



4. Stored parameters will be uploaded into the Analyzer's Configuration Menu.

## Chapter 14: Report Printing

To print a Drying Report of a performed analysis, press the data transfer (PRINT)  key.

Drying started:	
-----	
Date:	2006-10-17
Time.:	13:03:24
Drying parameters	
-----	
Product	
Drying temperature : 119°C	
Mode	: m0-m/m0*100%
Finished	time over
Initial weight	: 0.000 g
Final weight	: 0.000 g
Drying time	: 0:00:00s.
Sampling interval:	: 10s
Moisture	: 0.00%
NOTE:	
The analysis proceeded by:	
Signature	.....

## Chapter 15: Testing the Analyzer with Sodium Tartrate Dihydrate

**Important:** Always wear protective goggles over your eyes and rubber gloves when handling Sodium Tartrate Dihydrate.

### Warning:

If inhaled, Sodium Tartrate Dihydrate may cause mild irritation to the respiratory tract. If the chemical comes in contact with skin or eyes, it may also cause mild irritation. If swallowed, a large dose may cause gastrointestinal disturbances.

### First Aid:

- **If inhaled**, immediately move to an area with sufficient fresh air. Get medical attention for any breathing difficulty.
- **If ingested**, drink several glasses of water or milk. If a large amount was swallowed, get medical advice.
- **If skin contact occurs**, wash exposed area with soap and water. Get medical advice if irritation develops.
- **If eye contact occurs**, wash eyes thoroughly with water. Get medical advice if irritation develops.

Sodium Tartrate Dihydrate is a chemical compound that can be used as a standard to check the accuracy of the Moisture Analyzer. When the chemical is heated to 150°C, it undergoes a change that releases moisture (theoretically 15.66%) so the chemical should lose 15.51% to 15.81% of its weight. The “ $m_0 - m / m_0 * 100\%$ ” formula will show the results directly. With a sample weight of 5 grams, set the drying time to 10 minutes to be sure the chemical action is complete. If the chemical has been stored at elevated temperatures or subjected to mechanical abuse, the results may vary. Be sure to spread the sample evenly throughout the disposable pan.

### Recommended Parameters

**Mode:** Time Mode

**Calculation:**  $m_0 - m / m_0 * 100\%$

**Drying Temperature:** 150

**Sample Quantity:** OFF

**Sampling Interval:** 3sec

**Drying Time:** 10:00 minutes

**Note:** Make sure the disposable pan is cool before placing the sample.

## Chapter 16: Weighing

1. To begin weighing, press the Mode Return key ( $\rightarrow \rightarrow$ ) to switch from a Moisture Analyzing Mode to a Weighing Mode or vice versa. The scale is ready to begin weighing as soon as the stabilization indicator ( ) appears on the display.

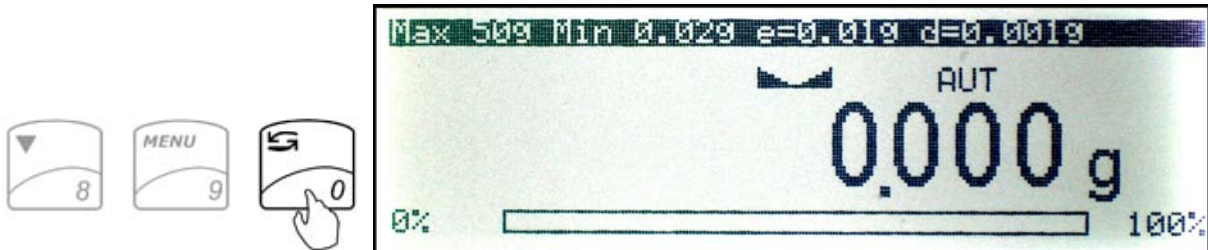

2. When weighing, always place the mass in the middle of the pan. The weighed result may be taken when the stabilization indicator appears on the display.

### 16.1. Taring

1. If a container is used for weighing, it may be tared. In taring the container, the scale subtracts the weight of the container from the gross weight to obtain the net weight.
2. To tare the weighing container, place it in the middle of the pan. The container's weight will be shown on the display.



- Once the stabilization indicator appears on the display, the container is ready to be tared. To tare the container, press the T button. The display will show a dotted line which indicates the scale has begun the taring process.

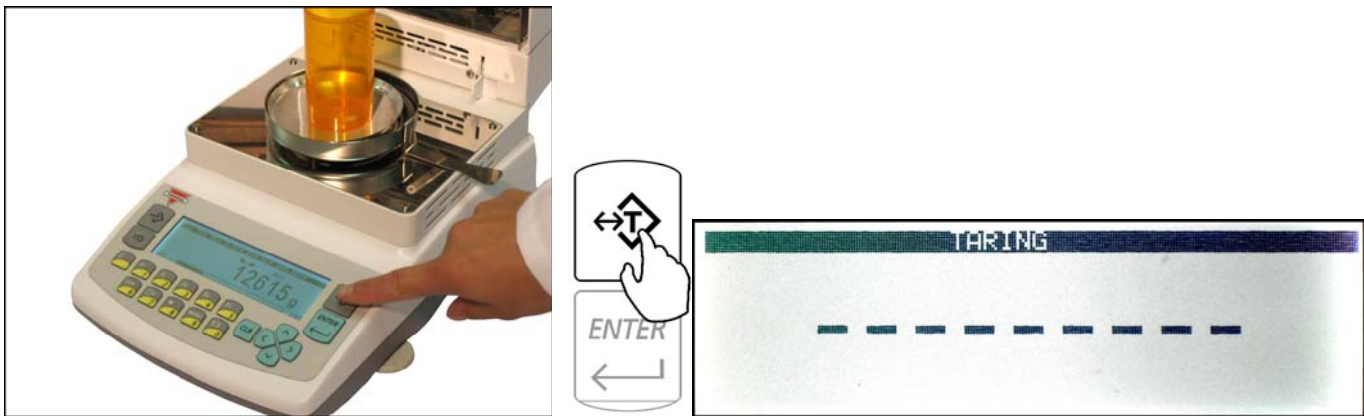

- When finished taring, the balance will return to Weighing Mode. The display will indicate 0, and the NET indicator will be shown on the display signaling the next weight taken is a NET result.

**Note:** Do not touch or move the scale during the taring process.

## 16.2. Clearing a Tare

- To clear the tare, remove the tared object along with the NET weight from the pan. The scale will then display a negative NET tare result.

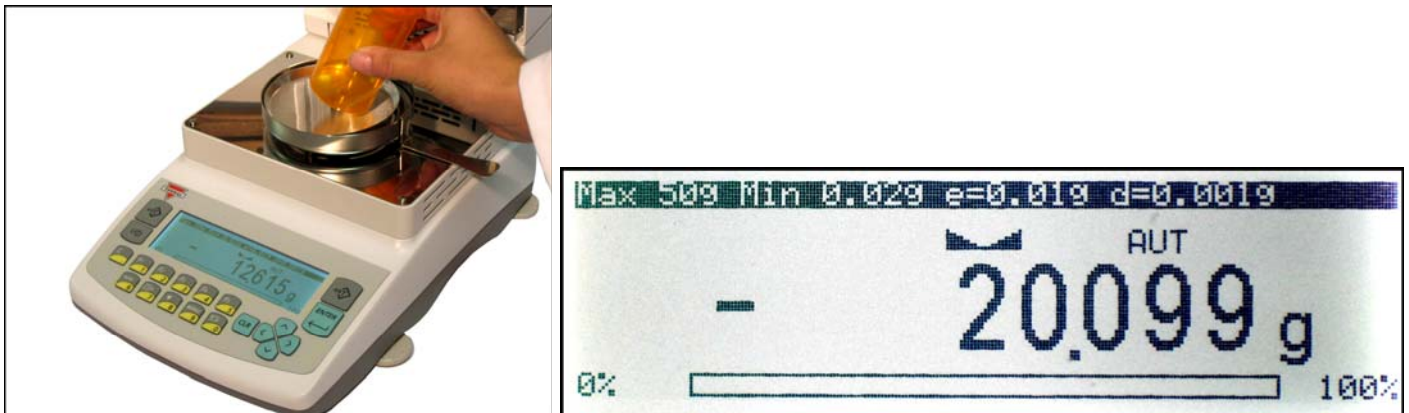

- To clear the tare, press the T button.



- The display will show dashed lines indicating the tare is clearing.

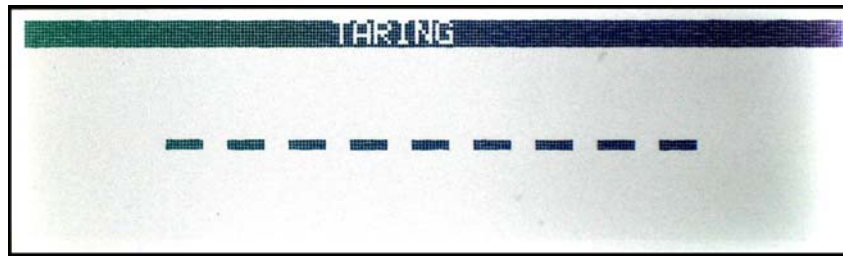

- When finished clearing the tare, the scale will return to Weighing Mode.

## Chapter 17: Parts Counting

**Note:** In order to perform Parts Counting, the analyzer must be in the Weighing Mode.

### 17.1. Using a Custom Sample Size

- Place a container on the Analyzer's pan and press the T key to tare. After taring the container manually, count out the sample you want to be used for calculating the average piece weight of your counting transaction.

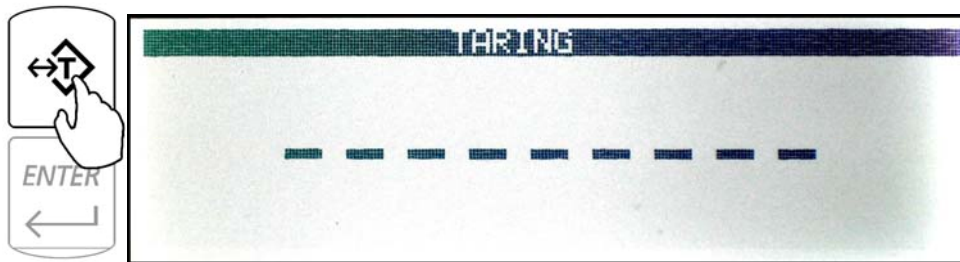

- Place the sample in the container.
- The weight of the sample will be displayed as it is placed on the pan. Once the weight of the sample stabilizes and the stability indicator appears on the display, press the MENU key to enter the main menu.



- Use the navigation keys to select *PCS* and press the Enter key

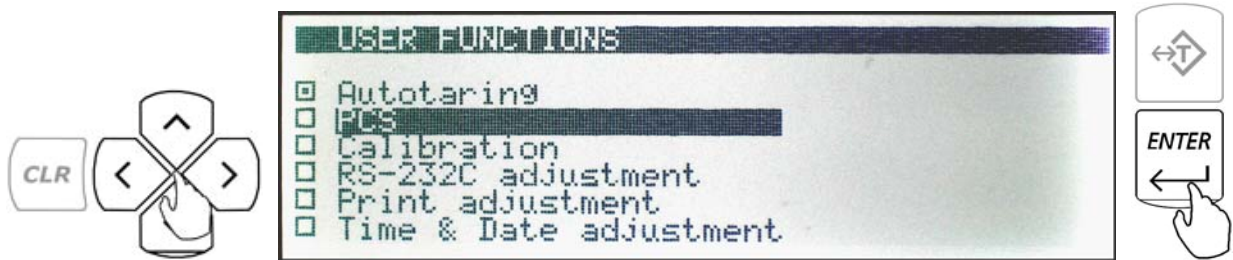

- Use the navigation keys once again to select *Pieces Quantity* and press the ENTER key.

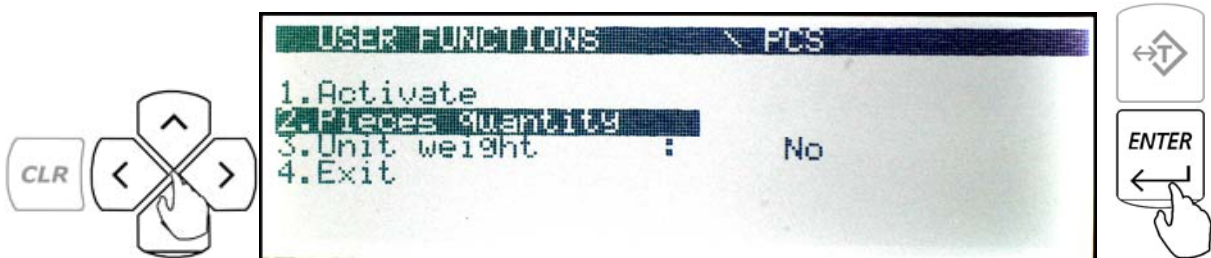

- Using the numeric keys, enter the value of your sample size placed in the container and press the ENTER key.



- Once your custom sample size value has been entered, use the navigation keys to select option number "1" *Activate* and press the ENTER key.



- The scale will display the count of the sample. At any time you can proceed with the count.

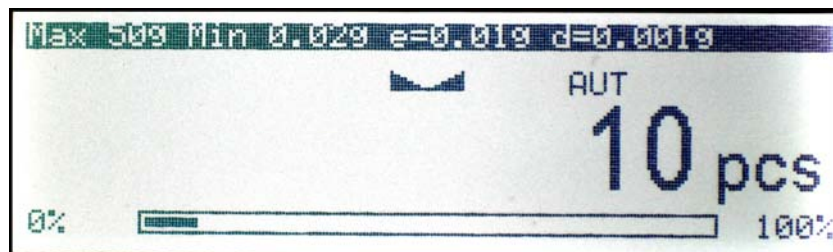



- Once an accurate count has been taken, the container and its contents may be removed from the scale.

To exit parts counting and return to basic weighing, select *Deactivate* from the parts counting menu.



## 17.2. Counting Based on a Known Individual Piece Weight

- Place a container on the scale's pan and press the T key to tare.

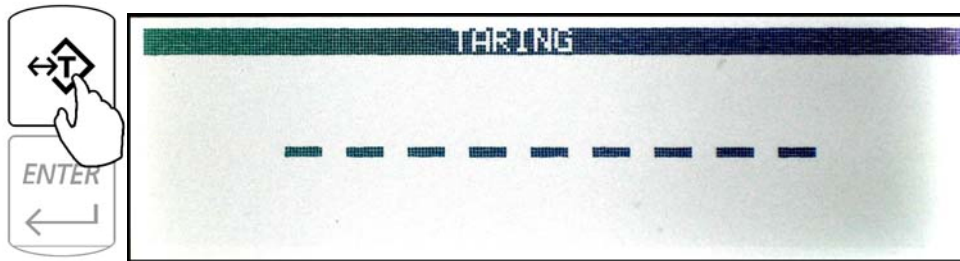

- Press the MENU key to enter the main menu.



3. Use the navigation keys to select *PCS* and press the ENTER key.

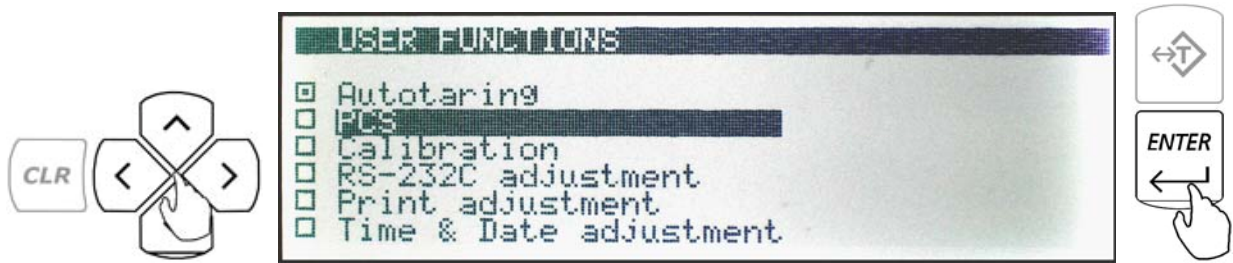

4. Use the navigation keys once again to select Unit Weight and press the ENTER key.



5. Using the numeric keys, enter the exact individual piece weight of the counted parts.
6. Once the exact individual piece weight has been entered, use the navigation keys to select option number 1 *Activate* and press the ENTER key.
7. The scale will display “0pcs”. At any time, proceed with the count.



8. Once an accurate count has been taken, the container and its contents may be removed from the scale.  
To exit parts counting and return to basic weighing, select “Deactivate” from the parts counting menu.



# Chapter 18: Calibration

When the Analyzer is initially installed, it must be calibrated to ensure accurate weighing results. Calibration should be performed periodically or whenever the unit is moved to a different location. Before calibrating the Analyzer, have the appropriate calibration weight available.

**Note:** In order to perform Calibration, the Analyzer must be in the Weighing Mode.

1. Press the Menu key to enter the Main Menu of the weighing mode.



2. Use the navigation keys to select *CALIBRATION* and press the ENTER key

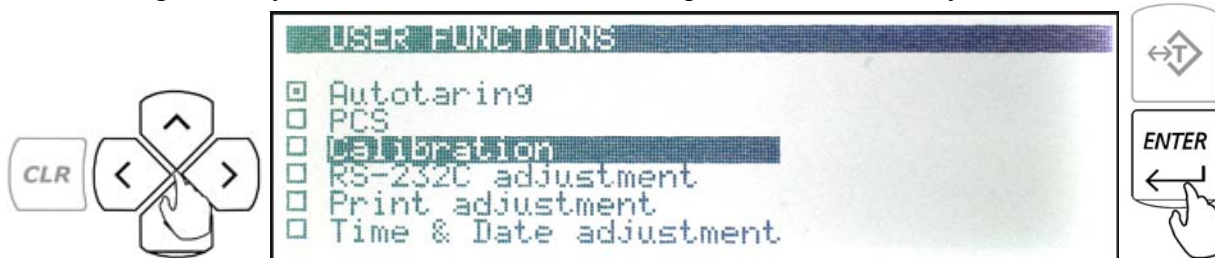

3. To change the calibration mass, use the navigation keys to select *EXTERNAL LOAD* and press ENTER.

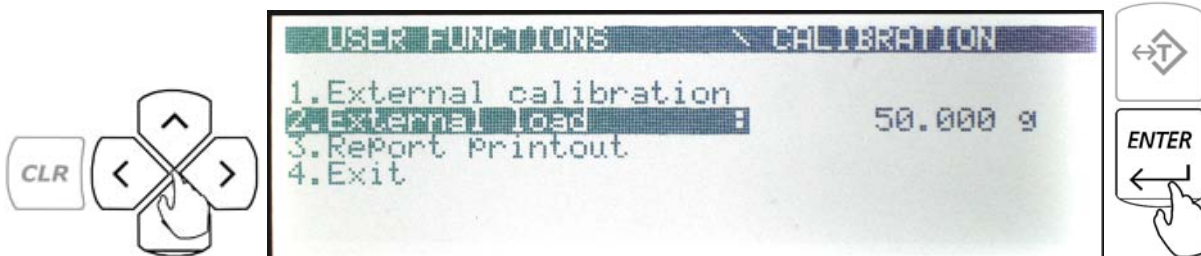

4. Use the navigation keys to select the allowed external loads for calibration. The load equal to full scale range is recommended. Be sure the weight used for the External Load is of sufficient accuracy for your purpose. Once the Calibration mass has been selected press the ENTER key to accept the External Load selection.

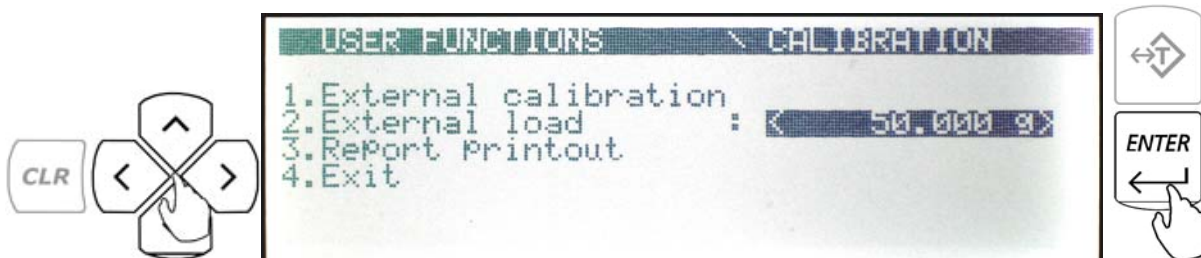

- To begin Calibration, select option 1. *EXTERNAL CALIBRATION* and press the ENTER key to start the calibration process.

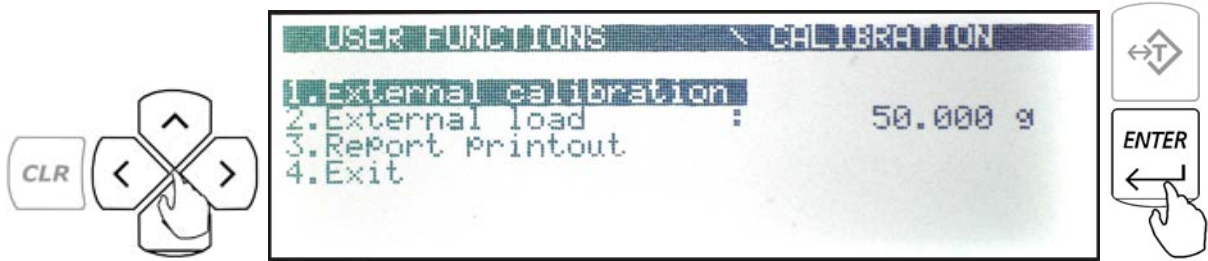

- Before calibration begins, the scale will perform an automatic tare.

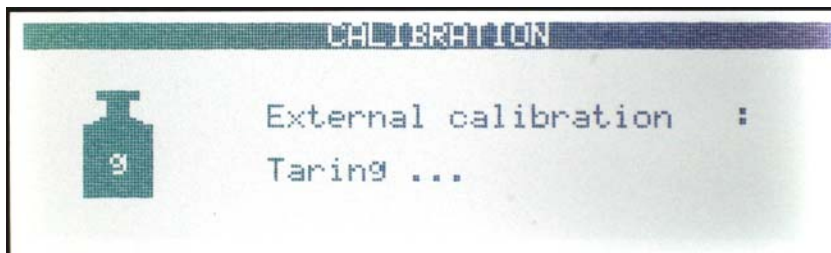

- After the tare is complete, the screen requests that the External Load, whose value is shown on the screen, be placed on the pan.

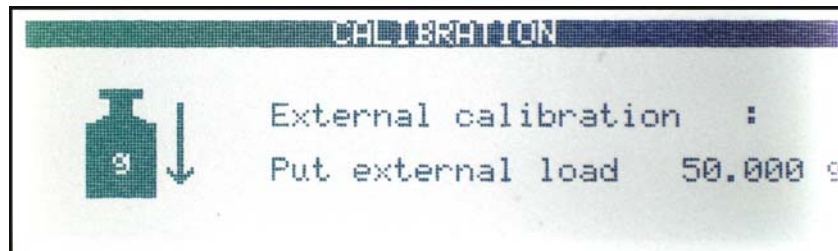

- Place the External Load on the pan.

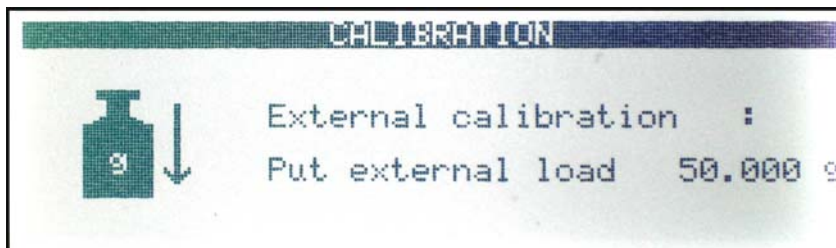

9. When the calibration weight is placed on the pan, the scale will automatically begin the calibration process.



10. When calibration is complete, the unit requests that the External Load be removed. When the Load is removed from the unit, the screen requests a waiting period, which is followed by a screen showing dashes (-----). After completing the calibration process, the unit will return to the Calibration Menu.



11. To get a Report Printout of the calibration results, use the navigation keys to select 3. *REPORT PRINTOUT* and press the ENTER key. Calibration Data will be sent to the external printer.

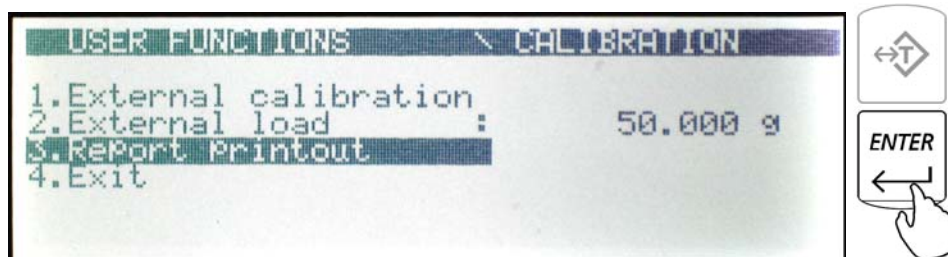

12. To exit the Calibration menu, select *EXIT* and press the ENTER key.

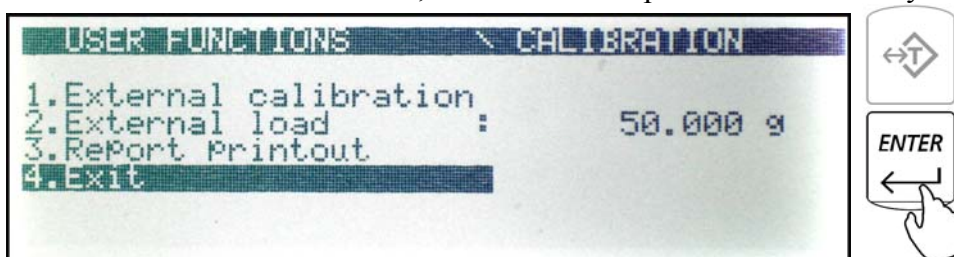

# Chapter 19: Main Menu

## 19.1. Autotaring

1. Enter the main menu by pressing the MENU key.



2. Use the navigation keys to select “Autotaring” and press ENTER.

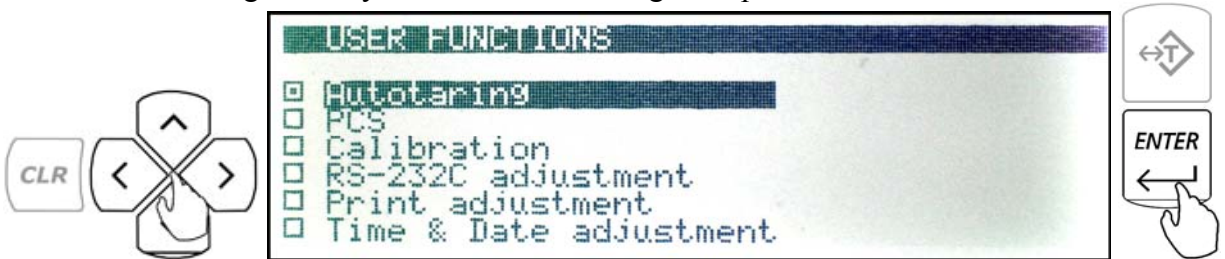

3. To deactivate or activate the Autotaring function, select option (1) and press the ENTER key.

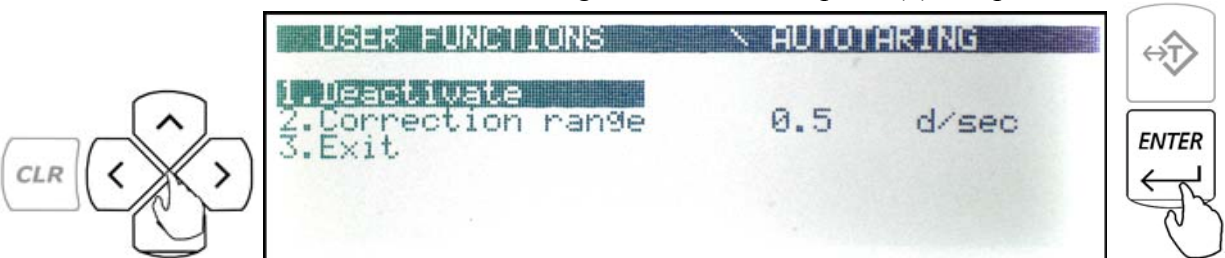

4. To change the auto zeroing range, use the navigation keys to select option (2) *Correction Range* and press the ENTER key.

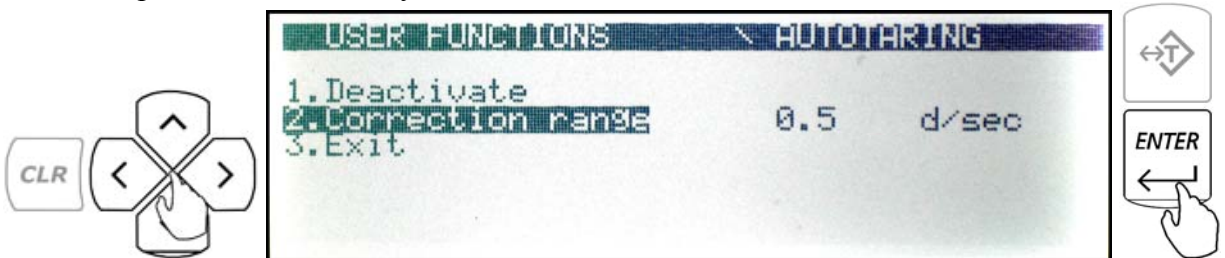

5. Using the numeric keys to enter the desired Autotaring range between 0.5d and 5.0d.

6. Once the new range has been entered, press the ENTER key to save the setting.



## 19.2. RS232 Serial Port Configuration

1. Enter the main menu by pressing the MENU key.



2. Use the navigation keys to select RS232 and press ENTER.

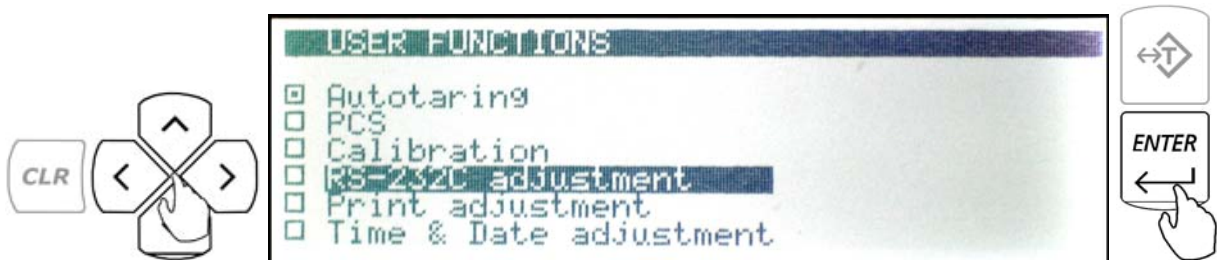

3. To configure the “RS232 Port”, use the navigation keys to select the desired parameter, press the ENTER key, and then once again use the navigation keys to make the desired selection.



4. Once the selection is made, press the ENTER key to save the setting.

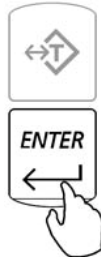

### 19.3. Print Adjustment

1. Enter the main menu by pressing the MENU key.

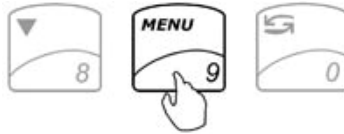

2. Use the navigation keys to select “Print Adjustment” and press ENTER.

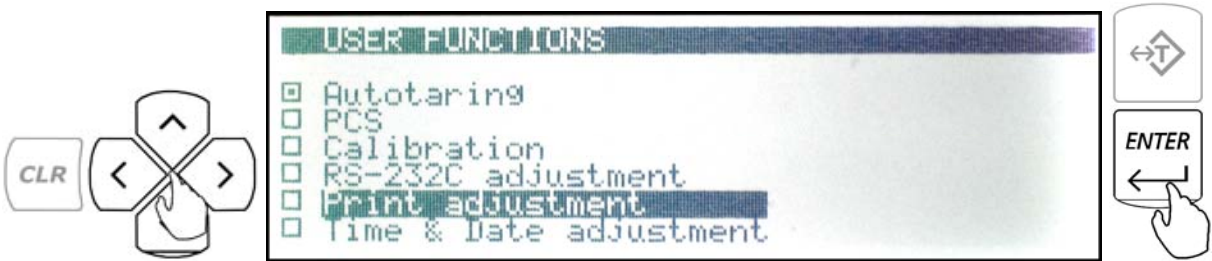

3. In order to have the Measurement Number or the Date and Time printed on the weighing report, use the navigation keys to make a selection and press the ENTER key.

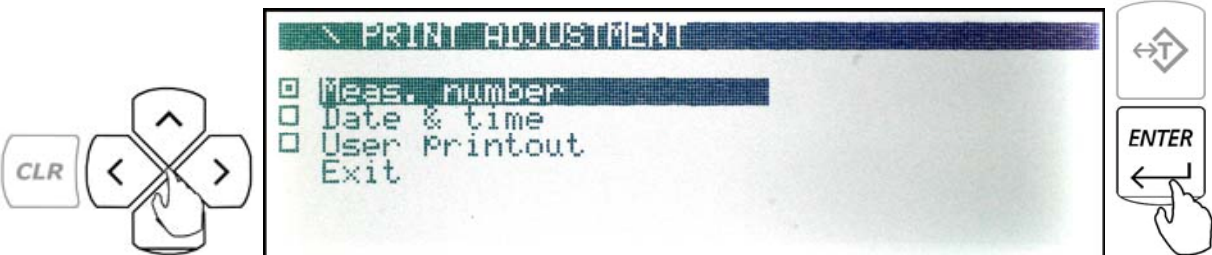

### 19.4. Time and Date

1. Enter the main menu by pressing the MENU key.



2. Use the navigation keys to select “Time and Date” and press ENTER.

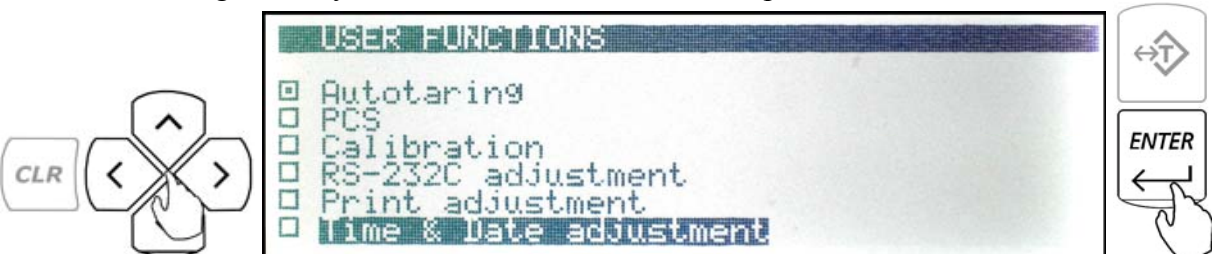



- To adjust the time, use the navigation keys to select *Time* and press ENTER.

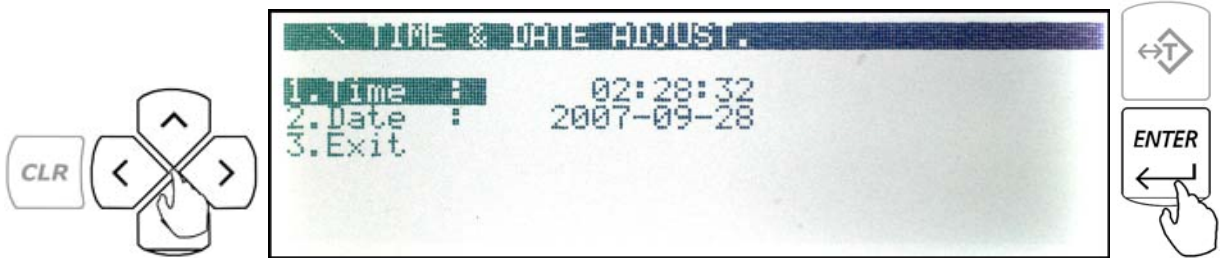

- Using the numeric keys to enter the current time. The time is entered in segments: hours, minutes, and seconds. After entering a segment, press the ENTER key to move to the next segment.



- To change the date, select *Date* with the navigation keys and press ENTER. Using the numeric keys to enter the current date. The date is entered in segments: day, month, and year 00/00/0000. After entering a segment, press the ENTER key to move to the next segment.



### 19.5. Language

- Enter the Main Menu by pressing the MENU key.



- Use the Navigation keys to select *LANGUAGE* and press the ENTER key

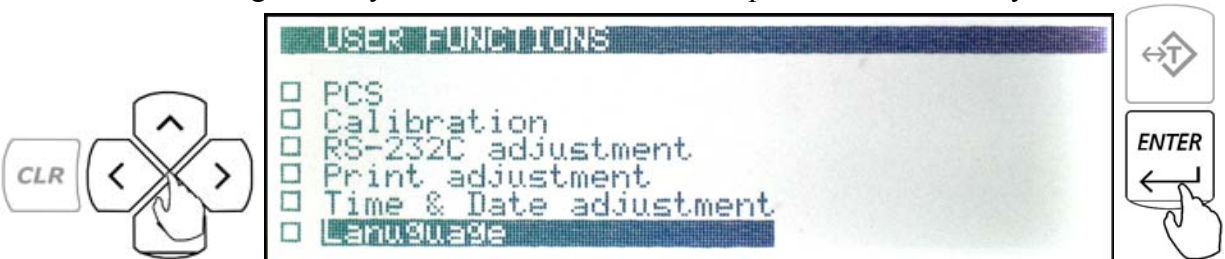

- Available languages will be displayed: *Polish, German, English, Russian, Ukrainian, French,* and *Spanish*. Use the navigation keys to choose the language you wish to select and press the ENTER key.



### 19.6. LCD Setting

- Enter the main menu by pressing the MENU key.



- Use the navigation keys to select *LCD SETTINGS* and press ENTER.

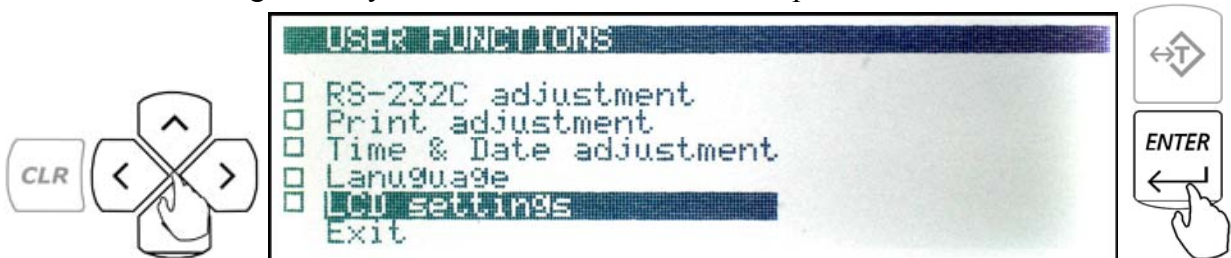

- To change the contrast of your LCD display, select *Contrast* and press the ENTER key.



- Use the left and right arrow navigation keys to adjust the contrast of your display. Once the contrast is at the desired level, press the ENTER key to save the setting.



5. To completely turn off the back light of the LCD display, select *Back Light* and press ENTER.



6. Using the left and right arrow navigation keys, select *OFF*. Once the back light is turned off, press the ENTER key to save the setting.



## Chapter 20: Halogen Bulb Replacement and Analyzer Maintenance

### Cleaning the Analyzer

- Before cleaning the unit or replacing halogen bulbs, always unplug the power cord from the electrical outlet.
- Before performing any maintenance on the unit, make sure all parts and surfaces of the Analyzer have cooled.
- Use a soft, **lint-free**, slightly damp cloth to clean the Analyzer.
- Wipe the unit gently. Do not allow any liquid to enter into the Analyzer's weighing or drying mechanisms.
- Do not touch the temperature sensor (see parts description).
- Do not apply extensive pressure to the LCD display.
- Do not use chemicals especially benzene when cleaning the surface. Corrosive chemicals may damage the finish.
- Alcohol may be used only to clean the scale's stainless steel pan support or the pan handle.
- To prolong the life of the halogen bulbs, be sure the bulbs are clean and free from fingerprints. Even a small amount of oil from your fingers can cause the bulb to break when it is turned on.

### Replacing the Halogen Bulb

Replace the halogen bulbs when they are defective or when you sense that drying is taking more time than usual.

#### **Warning:**

- Before replacing the halogen bulb, avoid electrical shocks by unplugging the power cord from the electrical outlet.
- Make sure the rated voltage of the new halogen bulbs is correct for the voltage of the power supply.
- Handle the old bulb with care to avoid cracking. Broken glass may cause injury.
- Never touch a halogen bulb with your bare fingers.
- Always wear gloves when handling a new bulb. Even a small amount of oil from your fingers can cause the bulb to break (or shorten its life) when it is turned on.
- If a bulb is touched, before being used it may be cleaned with a lint-free cloth.
- When replacing the bulbs in the Analyzer, make sure to avoid touching the temperature sensor.

## Chapter 22: Common Errors and Troubleshooting

Problem	Explanation / Solution
<i>The sample burns during analysis</i>	<ul style="list-style-type: none"> <li>• Reduce the drying temperature.</li> <li>• Reduce the size of the sample and make sure it is uniformly distributed on the pan.</li> <li>• If necessary, place a glass fiber filter on top of the sample.</li> </ul>
<i>The drying process takes a very long time</i>	<ul style="list-style-type: none"> <li>• Increase the drying temperature.</li> <li>• Reduce the mass of the sample.</li> </ul>
<i>Drying takes longer than usual</i>	<ul style="list-style-type: none"> <li>• Halogen Bulbs may need to be replaced.</li> </ul>
<i>A sample loses weight before the analysis begins</i>	<ul style="list-style-type: none"> <li>• Do not place the sample on the disposable pan inside of the drying chamber.</li> <li>• Remove the disposable pan, place the sample outside of the chamber, then quickly place it back in the chamber for analysis.</li> </ul>
<i>The sample turns into a liquid</i>	<ul style="list-style-type: none"> <li>• Use glass fiber filters to analyze the sample.</li> </ul>
<i>The sample doesn't contain enough volatile matter</i>	<ul style="list-style-type: none"> <li>• Increase the size of the sample.</li> </ul>

Error	Cause	Explanation / Solution
<i>Load error!</i>	Scale load at start up exceeds 10% of the scale MAX capacity	The pan was not empty while the scale was initiating at start-up. Clear the pan and restart the scale.
<i>Capacity exceeded!</i>	Scale range exceeded	The scale has exceeded its weighing capacity. Reduce the weight.
<i>Tare range exceeded!</i>	Attempt to tare the scale that is beyond the Tare range	Place a weight on the pan before taking a tare.
<i>Tare value not cleared!</i>	Attempt to zero the scale without clearing a prior tare	Remove weight from pan and clear store tare values.
<i>Load error! (C01)</i>	Load error while initializing. The pan mass is below 10% of the stored value.	Do not touch or move the scale while calibration is in progress. The pan MUST be empty and properly installed.
<i>Load error! (C02)</i>	Load error while initializing. The pan mass is over 10% of the stored value.	Do not touch or move the scale while calibration is in progress. The pan MUST be empty and properly installed.



If any of the following errors are displayed, please contact technical support at (973)-473-6900:

<i>EEPROM1 Error</i>	EEPROM1 memory error (shortage of memory, memory is damaged, or check sum error)
<i>EEPROM2 Error</i>	EEPROM2 memory error (shortage of memory, memory is damaged, or check sum error)
<i>EEPROM Error!</i>	EEPROM1 or EEPROM2 memory error
<i>CRC Error xx</i>	Check sum error number xx in EEPROM memory
<i>Service switch OFF!</i>	Attempt to access the Service mode with the Service Switch in the OFF position
<i>A/D range exceeded!</i>	A/D converter range exceeded
<i>A/D converter read error!</i>	No response from A/D converter
<i>Temperature sensor error!</i>	No response from the temperature sensor
<i>Service switch ON!</i>	Attempt to access the Service Mode without a service command



## Chapter 23: Replacement Parts

Description	Part No.
Power Cord	AGS9250
Pan Assembly	AGS9260
RS232 Printer Cable	AGS9270
Disposable Pans	AGS9280
Halogen Bulbs	AGS9290
Sodium Tartrate Dihydrate	AGS9291



## Chapter 24: Limited Warranty

### PURCHASER'S 12-MONTH WARRANTY

Warranty is valid only if the attached warranty registration card is completed and returned within 30 days.

This product is a precision device made to exacting standards of scientific accuracy. It is guaranteed to have been adjusted and inspected for proper workmanship and performance and to be certified for its currently advertised specifications before shipment.

Fulcrum Products are warranted against defects in material and workmanship under normal use and service. This warranty is extended only to the first purchaser. This limited warranty will not apply if, upon inspection, it is found that the product was tampered with, misused, overloaded, abused, mishandled, placed in an improper environment, improperly installed or adjusted, used for a purpose other than that for which it was designed, or repaired by unauthorized personnel.

Fulcrum's liability under this warranty is limited to furnishing the labor and parts necessary to remedy the defect covered by this warranty and restore the product to normal operating condition. Purchasers may be charged a minimum repair fee for in-warranty products returned for repair if those products are determined to be problem-free.

To make a claim under this limited warranty, obtain an RMA number from Fulcrum and return the product (carefully packed in its original packaging and shipping prepaid) with the RMA number written on the return package.