

# Fulcrum Inc.



## Instruction Manual:

**AG Precision PRO Series**

Models: AG100-AG500, AG1000-AG4000

**AGN Analytical PRO Series**

Models: AGN100-AGN200



# Table of Contents

1. Cautionary Notes and Precautions.....	3
1.1 Important Handling Cautions and Warnings.....	4
2. Specifications.....	5
3. Keys, Display Indicators and Abbreviations.....	7
4. Parts Descriptions.....	8
5. Unpacking Balance and Getting Started.....	10
6. External Keyboard Connection (optional).....	12
7. Functions, Descriptions and Definitions.....	13
8. Main Menu.....	14
8.1.Mode Setup.....	14
8.1.1. Weighing.....	15
8.1.2. Parts Counting.....	16
8.1.3. Check Counting.....	18
8.1.4. Percent Weighing.....	19
8.1.5. Totalizing.....	21
8.1.6. Compounding.....	22
8.1.7. Check Weighing.....	23
8.1.8. Animal and Dynamic Weighing.....	25
8.1.9. Display Hold.....	27
8.1.10.SQC Process Control.....	28
8.1.11.Tare Setup.....	30
8.2.Units of Measure.....	31
8.3.Configurations.....	32
8.3.1.Auto-Zero.....	32
8.3.2.Print.....	33
8.3.2.1GLP.....	33
8.3.2.2Print Details.....	34
8.3.3.Filter.....	34
8.3.4.Power Save and LCD Contrast.....	35
8.3.5.RS232.....	36
8.3.6.USB Configuration.....	36
8.3.6.1PC Connection via USB.....	37
8.3.7.Time and Date Adjustment.....	38
8.3.8.Reset and Default Restore.....	39
8.3.9.Erasing the Database.....	39
8.4.Calibration.....	40
8.4.1.Auto Calibration Setting and Adjustment.....	41
9. Using Functions and Modes.....	42
9.1. Weighing.....	42
9.1.1.Taring.....	42

▲		
9.1.2.	Clearing a Tare.....	43
9.2.	Parts Counting.....	44
9.2.1.	Automatic.....	44
9.2.1.1	Counting Parts for the First time.....	44
9.2.1.2	Counting Parts which Have Been Previously Stored in the Scale’s Database..	46
9.2.2.	Manual.....	48
9.3.	Check Counting.....	49
9.3.1.	Storing a Limit Set into the Scale’s Database.....	52
9.4.	Percent Weighing.....	52
9.4.1.	Automatic.....	52
9.4.1.1	Percent Weighing for the First Time.....	52
9.4.1.2	Percent Weighing with Stored Reference Weights.....	55
9.4.2.	Manual.....	56
9.5.	Totalizing.....	57
9.6.	Compounding.....	59
9.7.	Check Weighing.....	61
9.7.1.	Storing a Limit Set into the Scale’s Database.....	62
9.8.	Animal and Dynamic Weighing.....	63
9.9.	Display Hold.....	64
9.10.	SQC Process Control.....	65
9.10.1.	Storing a Limit Set into the Scale’s Database.....	66
10.	Using the Scale’s Alphabet for Data Entry.....	67
11.	Connecting and Using a Barcode Scanner with the Scale’s Database.....	68
11.1.	Connecting the Scanner.....	68
11.2.	Assigning Barcodes to Samples or Limit Sets.....	68
11.3.	Recalling a Previously Stored Sample or a Limit Set from the Database.....	68
12.	Technical Information.....	69
13.	Common Error and Troubleshoots.....	70
14.	Maintenance.....	71
15.	Accessories.....	71
16.	Replacement Parts.....	72
17.	Limited Warranty.....	72

# Chapter 1: Cautionary Notes



The TORBAL Precision scale is a sensitive and a delicate instrument. Always handle your scale with care.

The correct location and proper environment makes an important contribution to the accuracy of the weighing results of TORBAL precision scales.

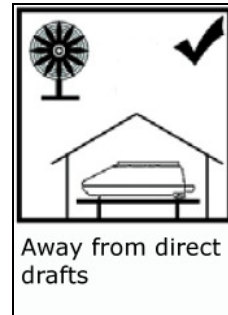
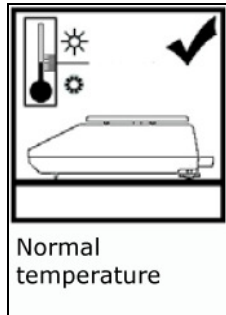
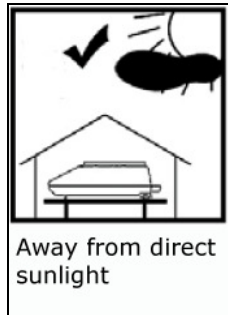
### The optimum location for your scale:



- Stable, vibration-free base as horizontal as possible
- Away from direct sunlight
- Not exposed to high temperature variations
- Away from direct drafts
- The best location is on a stable bench away from direct drafts, doors, windows, radiators and air conditioner vents.





<p><b>CAUTION:</b></p> 	<ul style="list-style-type: none"> <li>• The scale is designed for indoor use only..</li> <li>• Do not operate the scale in hazardous areas or conditions.</li> <li>• Do not use the scale in locations subject to high humidity or dust levels.</li> <li>• Do not connect cables in ways other than those mentioned in this manual.</li> <li>• Be sure to set the scale on a firm, stable, horizontal surface.</li> <li>• Never stand on or lean on this product. Equipment may fall or collapse, causing breakage and possible injury.</li> <li>• Before moving the product, unplug it and unplug all cables connected to it.</li> <li>• When storing, transporting or returning the scale for service, always use the original packaging.</li> </ul>
<p><b>WARNING:</b></p> 	<ul style="list-style-type: none"> <li>• Never attempt to repair, disassemble or modify the scale yourself. Tampering with the scale may result in injury and cause more damage to the equipment.</li> <li>• Be sure to use the specified power source.</li> <li>• Do not allow foreign matter to fall into the scale.</li> <li>• If water or other liquid spills into the scale, do not continue to use it. Unplug the power cord immediately and contact technical support.</li> </ul>



## 1.1. Important handling Cautions and Warnings

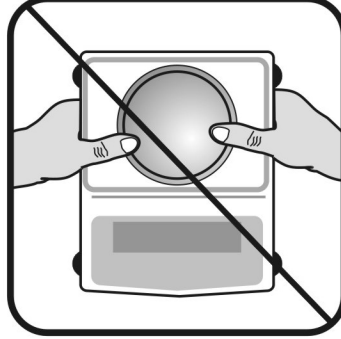

Always handle your scale with care. Damage caused by improper handling is not covered under the scale's warranty.

	<p>Never drop or throw any articles onto the scale's pan or onto any other parts of the unit!</p>
	<p><b>DO NOT</b> let the scale fall or drop from its tabletop surface!</p>
	<p>When moving the scale do not press or apply force onto the scales pan!</p>
	<p><b>DO NOT</b> pass or handle liquids directly over the scale to avoid spillage and liquid damage!</p>

# Chapter 2: Specifications

	Model							
	AG100	AG200	AG300	AG500	AG1000	AG2000	AG3000	AG4000
<b>Capacity</b>	100g	200g	300g	500g	1000g	2000g	3000g	4000g
<b>Readability (d)</b>	0.001g				0.01g			
<b>Repeatability (Standard Deviation)</b>	0.001g				0.01g			
<b>Linearity</b>	+/-0.002g				+/-0.02g			
<b>Stabilization time (typical)</b>	Approx. 3 sec				Approx. 3 sec			
<b>Tare Range</b>	-100g	-200g	-300	-500	-1000	-2000	-3000	-4000
<b>Accuracy Class</b>	I							
<b>Automatic Internal Calibration</b>	YES							
<b>Time Configuration</b>	1h, 2,h, 3h, 4h, 5h, 6h							
<b>Temperature Configuration</b>	0.5°C, 1.0°C, 1.5°C, 2.0°C							
<b>Automatic Calibration Adjustment Masses (g)</b>	20,50, 100	50, 100, 200	100, 200, 300	100, 200, 500	200, 500, 1000	500, 100, 2000	1000, 2000, 3000	1000, 2000, 4000
<b>Pan Dimension</b>	120 mm				165 mm x 165 mm			
<b>Draft Shield</b>	Optional				Not Required			
<b>Scale Dimension</b>	216 x 345 x 90 mm							
<b>Operating Temperature</b>	+15°C to +30°C							
<b>PS2 Port</b>	Standard							
<b>RS232 Port</b>	Bidirectional							
<b>USB</b>	Standard							
<b>Power Supply</b>	Input: 120VAC 60Hz 15W Output: 12VDC 500mA							
<b>Display Type</b>	Graphical LCD							
<b>Display Size</b>	30mm x 100mm							
<b>Application Modes</b>	Weighing, Parts Counting, Animal Weighing, Check Weighing, Display Hold, Percent Weighing, Totalizing, Check Counting, Compounding, Statistics, SQC Quality Control, 512 KB Library Bank							
<b>Weighing Units</b>	Grams, Milligrams, Kilograms, Carats, Pounds, Newton, Grains, Ounces Troy, Pennyweight							
<b>Scale's Net Weight (lb/kg)</b>	5kg/11lbs							
<b>Parts Counting</b>	<b>Sample Size</b>	1 through 100 or any						
	<b>Min Piece Weigh</b>	30mg			300mg			
<b>Check Counting</b>	<b>Sample Size</b>	1 through 100 or any						
	<b>Min Piece Weigh</b>	30mg			300mg			
<b>Percent Weighing</b>	<b>Min Reference Weight</b>	100mg			1 g			
	<b>% Resolution Displayed (Reference Weight)</b>	0.1% (100mg to 7g), 0.01% (7g to 70g) 0.001% (>70g)			0.1% (1g to 70g), 0.01% (70g to 700g) 0.001% (>700g)			
<b>Animal Weighing</b>	<b>Tiny Intervals</b>	3sec., 5sec., 10sec., 15sec.						
	<b>Modes (Min Weight)</b>	Manual, Auto (10mg), Semi-Auto (10mg)			Manual, Auto (100mg), Semi-Auto (100mg)			
<b>Totalizing</b>	<b>Modes (Min Weight)</b>	Manual, Auto (10mg), Semi-Auto (10mg)			Manual, Auto (100mg), Semi-Auto (100mg)			
<b>Display Hold</b>	<b>Modes (Min Weight)</b>	Manual, Auto (10mg), Semi-Auto (10mg)			Manual, Auto (100mg), Semi-Auto (100mg)			

	Model	
	AGN100	AGN200
<b>Capacity</b>	100g	200g
<b>Readability (d)</b>	0.0001g	
<b>Repeatability (Standard Deviation)</b>	0.0001g	
<b>Linearity</b>	+/-0.0002g	
<b>Stabilization time (typical)</b>	Approx. 3 sec	
<b>Tare Range</b>	-100g	-200g
<b>Accuracy Class</b>	I	
<b>Automatic Internal Calibration</b>	YES	
<b>Time Configuration</b>	1h, 2h, 3h, 4h, 5h, 6h	
<b>Temperature Configuration</b>	0.5°C, 1.0°C, 1.5°C, 2.0°C	
<b>Automatic Calibration Adjustment Masses (g)</b>	20,50, 100	50, 100, 200
<b>Pan Dimension</b>	120 mm	
<b>Draft Shield</b>	Optional	
<b>Scale Dimension</b>	216 x 345 x 90 mm	
<b>Operating Temperature</b>	+15°C to +30°C	
<b>PS2 Port</b>	Standard	
<b>RS232 Port</b>	Bidirectional	
<b>USB</b>	Standard	
<b>Power Supply</b>	Input: 120VAC 60Hz 15W Output: 12VDC 500mA	
<b>Display Type</b>	Seven Segment LCD	
<b>Display Size</b>	30mm x 100mm	
<b>Application Modes</b>	Weighing, Parts Counting, Animal Weighing, Check Weighing, Display Hold, Percent Weighing, Totalizing, Check Counting, Compounding, Statistics, SQC Quality Control, 512 KB Library Bank	
<b>Weighing Units</b>	Grams, Milligrams, Kilograms, Carats, Pounds, Newton, Grains, Ounces Troy, Pennyweight	
<b>Scale's Net Weight (lb/kg)</b>	6kg/14lbs	
<b>Parts Counting</b>	<b>Sample Size</b>	1 through 100 or any
	<b>Min Piece Weigh</b>	3e (30mg)
<b>Check Counting</b>	<b>Sample Size</b>	1 through 100 or any
	<b>Min Piece Weigh</b>	3e (30mg)
<b>Percent Weighing</b>	<b>Min Reference Weight</b>	1e (1mg)
	<b>% Resolution Displayed (Reference Weight)</b>	0.1% (100mg to 7g), 0.01% (7g to 70g), 0.001% (>70g)
<b>Animal Weighing</b>	<b>Tiny Intervals</b>	3sec., 5sec., 10sec., 15sec. or any
	<b>Modes (Min Weight)</b>	Manual, Auto 1e (1mg), Semi-Auto 1e (1mg)
<b>Totalizing</b>	<b>Modes (Min Weight)</b>	Manual, Auto 1e (1mg), Semi-Auto 1e (1mg)
<b>Display Hold</b>	<b>Modes (Min Weight)</b>	Manual, Auto 1e (1mg), Semi-Auto 1e (1mg)

## Chapter 3: Keys, Display Indicators and Abbreviations

Key	Primary Function	Secondary Function
I/⏻	Power On and Power Off	-
↔⚖	Tare – used to tare the weighing pan	N/A
→0←	Zero – used to zero the scale (Legal for Trade models only)	N/A
ENTER ↵	Enter – used to accept and confirm commands	N/A
MENU	Menu – used to access the main menu	Number "9" key
CLR	Clear – used to clear and cancel operation	N/A
▲▼◀▶	Navigation Keys – used to navigate through the menus and functions	N/A
↻	Function Key – used access database and secondary function	Number "0" key
📡	Data Transfer – used to print data or transfer data to a PC via the RS232 communication port	Number "7" key
▼	Calibration Key - used to initialize internal calibration	Number "8" key
F1	Function Key	Number "1" key
F2	Function Key	Number "2" key
F3	Function Key	Number "3" key
F4	Function Key	Number "4" key
F5	Function Key	Number "5" key
Display Indicator	Description	
▬	Stability Indicator - The weighing result has stabilized and an accurate reading may be taken.	
↔0←	Zero - The scale is maintaining a "center of zero" condition. (Legal for Trade models only)	
AUT	AZSM (Automatic Zero Setting Mechanism) is enabled. Always enabled in Legal for Trade models.	
OFF	Power Off - The scale is turned OFF and in standby mode.	
Diff.	Difference	
SPL / SAPL	Sample or Samples	
LOCK	Display Locked	
PCS	Parts Counting	
CHKC	Check Counting	
PERC	Percent Weighing	
TOT	Totalizing	
COMP	Compounding	
CHKW	Check Weighing	
ANL	Animal Weighing	
HLD	Display Hold	
SQC	SQC Process control	

# Chapter 4: Parts Description

## AG Models:



Front View



Rear View



Side View



Pan Base



Pan



AC Adapter

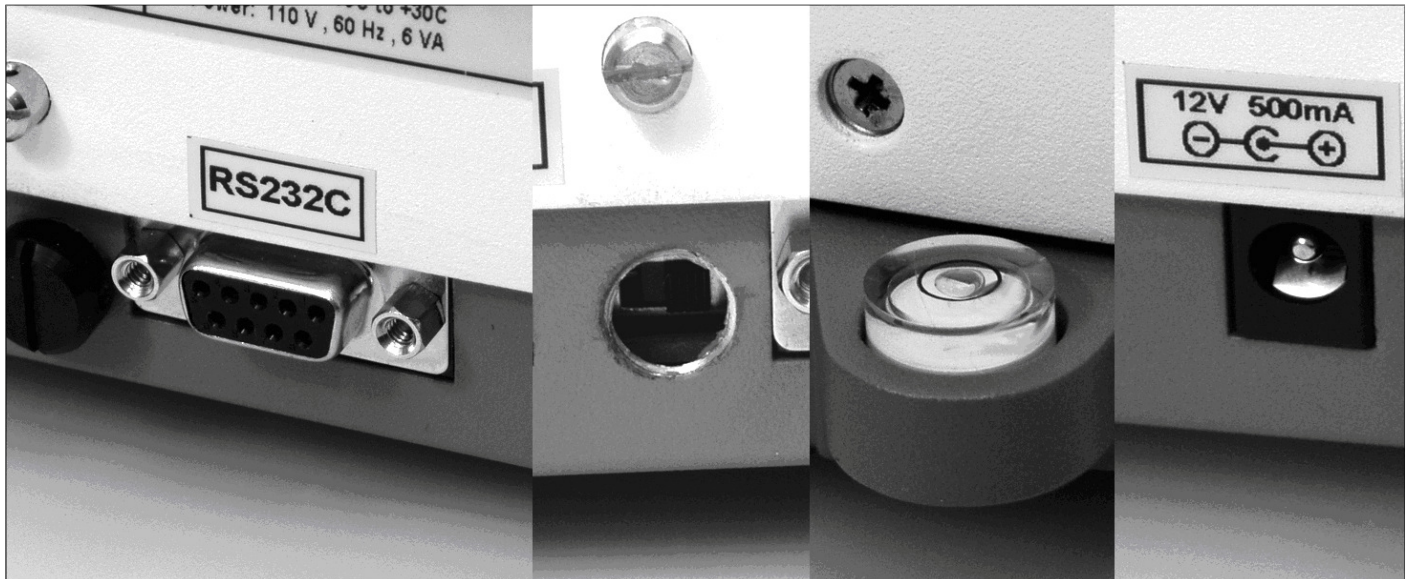

RS232 Serial Port

Service Switch

Level Indicator

AC Adapter Socket



**AGN Models:**

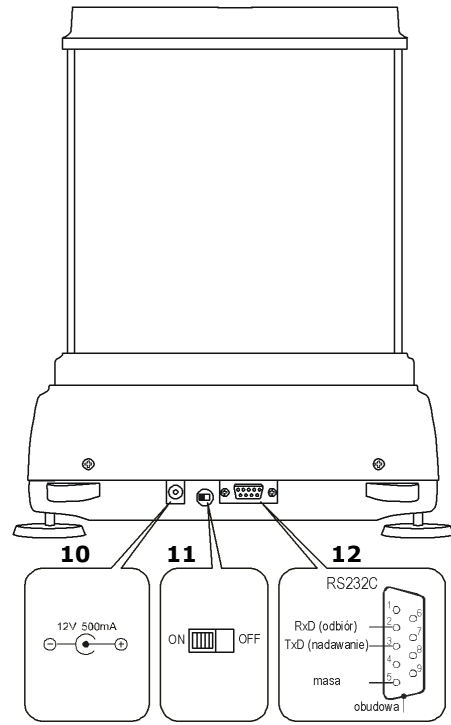
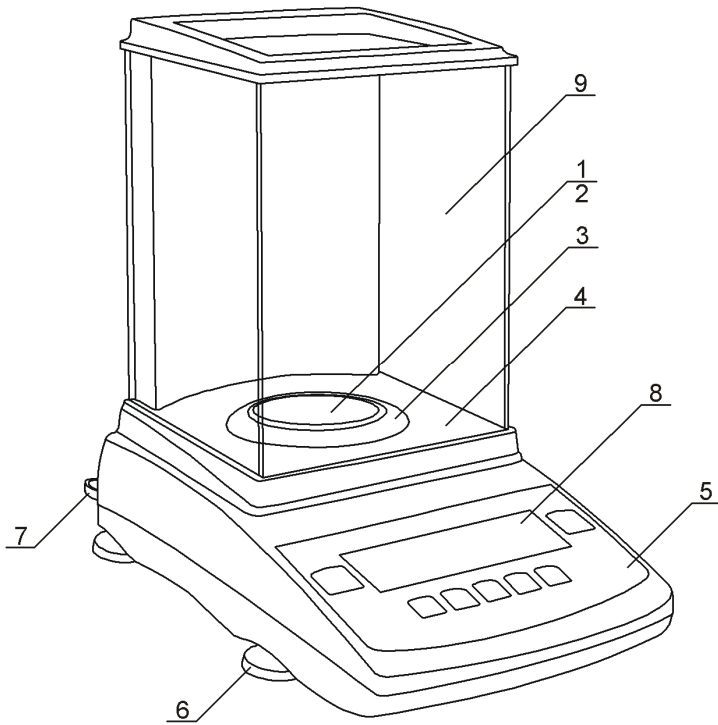

1 - Pan, 2 - Pan Base, 3 - Draft Ring, 4 - Weighing Chamber Base, 5 – Keypad, 6 - Adjustable Legs, 7 - Level Indicator, 8 - LCD Display, 9 - Weighing Chamber, 10 - AC Adapter Socket, 11 – Service Switch, 12 - RS232C Serial Port

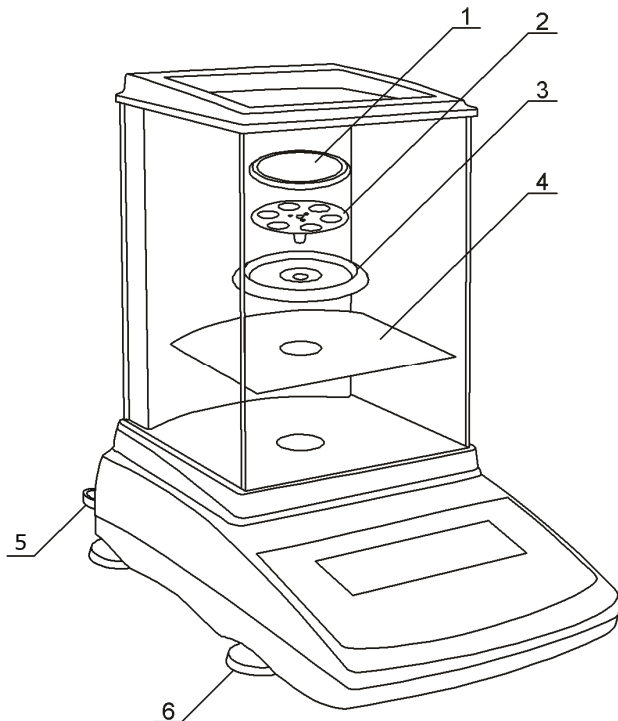

1 - Pan, 2 - Pan Base, 3 - Draft Ring, 4 - Chamber Base, 5 - Level Indicator, 6 - Adjustable Legs

## Chapter 5: Unpacking the Balance and Getting Started

1. Carefully remove the scale, pan, and all of its components out of the packaging and place them on a stable base where the scale will not be affected by any mechanical vibrations or air movements.



2. *AG Modes:* After removing the pan base and the pan from their packaging, carefully install the pan base onto the scale by seating it on the pan support located in the middle of the scale. Once the pan base has been installed, carefully place the pan on the base as shown below.

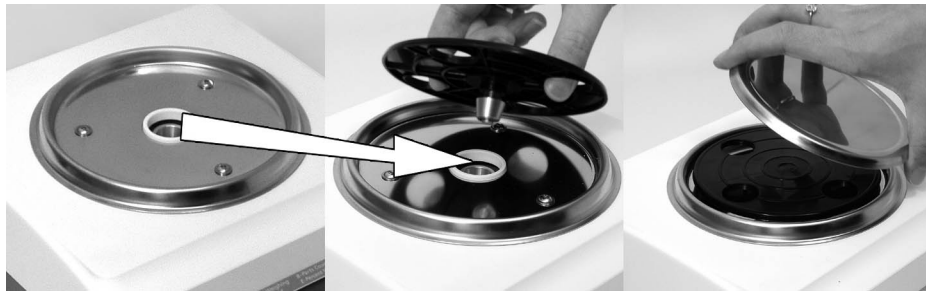

### *AGN Models:*

After removing the chamber base (4), draft ring (3), pan base (2), and the pan (1) from their packaging, carefully install the chamber base (4) on the case of the balance as shown below. Once the chamber base is in place, install the draft ring (3). Once components 4 and 3 are in place install the pan base onto the scale by placing it on the pan support located in the middle of the scale. Once the pan base has been installed, carefully place the pan on the base as shown.

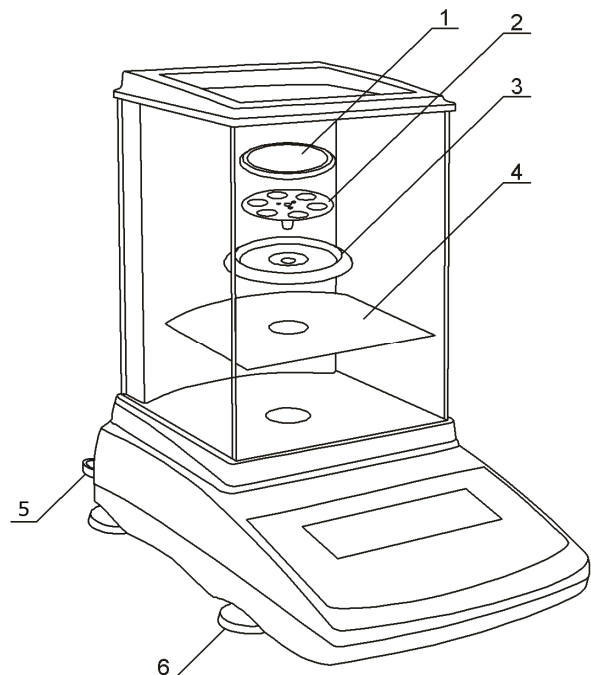

3. Once the pan has been installed, level the scale by adjusting the rear feet until the level indicator shows the “air bubble” is in the center position of the sight glass. The level indicator is located in the rear left side of the scale.

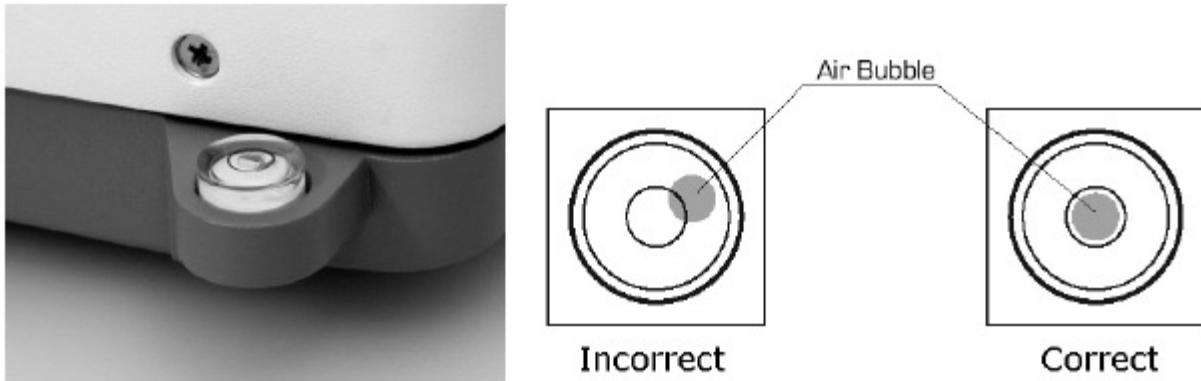

4. After leveling the scale, you may plug the AC adaptor to the AC adaptor socket located in the rear of the scale.



5. When the AC adapter is plugged into the wall outlet, the scale will turn “ON” automatically, initialize itself, perform automatic internal calibration and enter weighing mode.
6. To put the scale into standby mode, leave the AC adaptor plugged into both the scale and the wall outlet and press the Power “OFF” button (I/O). The “OFF” indicator will light up in the upper left corner of the display signaling the scale is in standby mode.

## Chapter 6: External Keyboard Connection (Optional)

Any PC external keyboard can be connected to the scale via the PS2. An external keyboard allows you to input data quickly and easily. To connect a PC keyboard to the scale, follow the steps below.

1. Clear the pan and turn the scale off.
2. Locate the keyboard connection port at the rear of the scale, marked “keyboard.”
3. Insert the keyboard connector into the scale’s port.



4. Turn the scale on.

Note: Some keyboard keys remain disabled and do not work with the scale (i.e. function keys, Shift, Control etc...). Do not use the number keypad located to the right of your keys. To key in numbers always use the number keys in the upper row of the keyboard.

## Chapter 7: Functions, Descriptions and Definitions

- **Parts Counting** is used to count parts or pieces of articles based on their average piece weight.

---

- **Check Counting** is used to verify whether a parts counting result falls within specified threshold limits.

---

- **Percent weighing** is used to establish the relative weight of an unknown, compared to that of a stored reference weight and expressed as a percent.

---

- **Totalizing** is used for summation of sequential weighing results of items or articles.

---

- **Compounding** is used for weighing and summing individual ingredients such as powders or liquids during recipe making or mixing compounds.

---

- **Check weighing** is used to check whether a weight of an object falls within specified threshold limits.

---

- **Animal and dynamic weighing** is used to weigh animals or objects which are in motion while on the pan.

---

- **Display hold** is used to lock and retain a weighing result on the display until cleared.

---

- **Statistical quality control (SQC)** is used to establish a trend analysis and statistical data of samples in relation specified threshold limits.



## Chapter 8: Main Menu

Main Menu is used to configure the scale and its weighing modes. Before entering the menu complete and clear active functions by pressing the CLR key.

1. To enter the Main Menu press the MENU key. Once the MENU key is pressed the menu options will be displayed.

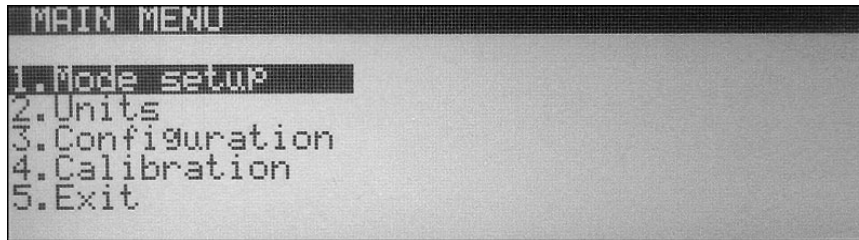

### 8.1. Mode Setup

Torbil AG and AGN Scales can operate in ten application modes: Weighing, Parts Counting, Check Counting, Percent Weighing, Totalizing, Compounding, Check Weighing, Animal Weighing, Display Hold, and SQC Process Control. Before an application mode can be used it must be enabled and configured. To use an application mode a quick key (Function keys F1 through F5) should be assigned (recommended). Quick keys allow quick toggling between functions. By factory default the scale is in the weighing mode. To enable other application modes follow the steps below.

1. From the Main Menu select “Mode Setup” and press the ENTER key. A list of available applications and modes will be displayed.

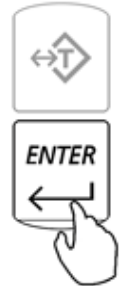

### 8.1.1. Weighing

- To configure the Weighing Function use the navigation keys to select “*Weighing*” in “*Mode Setup*” and press ENTER. The status and available weighing options will be displayed. If the function is currently in use the status will be set to “*ON*”.

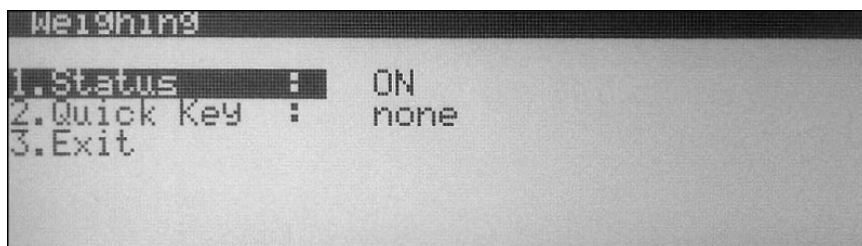
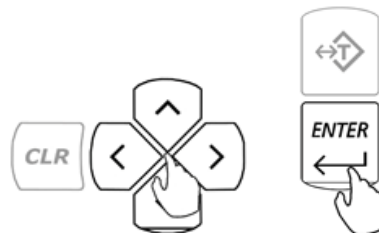
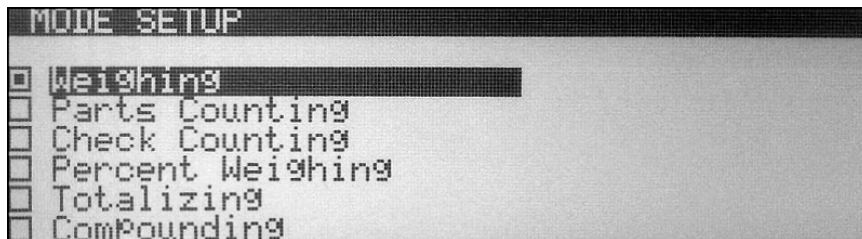

- To assign a “*Quick Key*” use the navigation keys to select “*Quick Key*” and press the ENTER key. Use the navigation keys to select a desired quick key (F1 through F5). Once the desired key is selected press the ENTER key to accept the selection.

If the key is not available (used by a different function) a warning message will be displayed “*Warning Quick Key Already In Use!*” To override the key press ENTER. To abort and select a different function key press the CLR key.

- To exit the Weighing set up select “*Exit*” and press the ENTER key.

### 8.1.2. Parts Counting

1. To configure the Parts Counting Function use the navigation keys to select “Parts Counting” in “Mode Setup” and press ENTER. The status and available parts counting options will be displayed. If the function is currently in use the status will be set to “ON”.

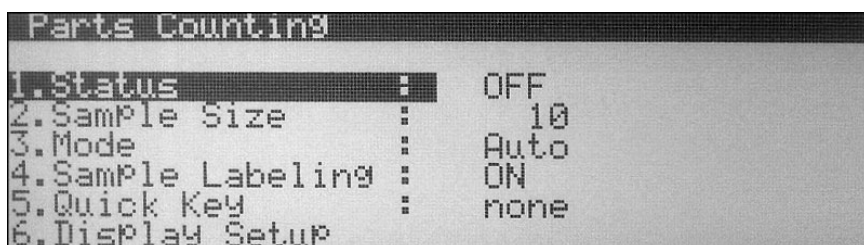
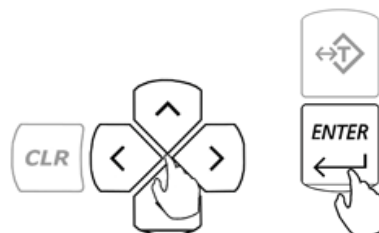
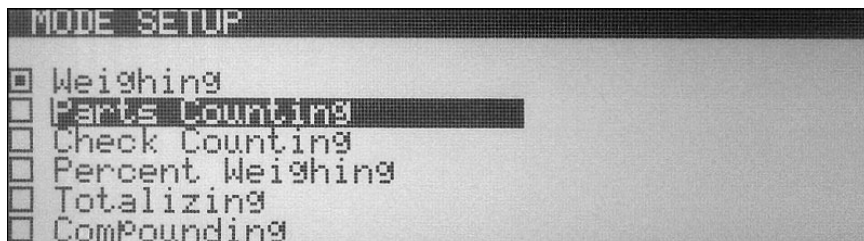

2. To assign a default “Sample Size” that will be used in calculating the average piece weight use the navigation keys to select “Sample Size” and press ENTER. To select a preset “Sample Size” use the navigation keys to toggle until a desired sample size is displayed (1, 5, 10, 20, 50, 100, 200, 500). To assign a custom “Sample Size” use the number keys on the scale’s keypad to key in a desired value. Once the desired “Sample Size” is selected or entered, press the ENTER key to set and confirm the selection.
3. To select an operating mode use the navigation keys to select “Mode” and press ENTER. By default parts counting is set to “Auto” (Automatic). To operate parts counting in “Manual” use the navigation keys to select “Manual” and press ENTER.

Parts Counting Operating Modes	
Automatic	When set to automatic the balance allows you to create a database of samples and average piece weights. Each sample can be labeled with a unique name or an alpha numeric code and stored in the scale’s internal memory along with its average piece weight. This eliminates the need for establishing a new average piece weight every time a part is counted.
Manual	When using parts counting in manual, the database feature is disabled and samples size, as well as, average piece weight is not stored in the scale’s memory. The sample size must be manually counted and an average piece weight must be established every time part counting is performed.

4. To enable sample labeling use the navigation keys to select “*Sample Labeling*” and press the ENTER key. Use the navigation keys once again to enable or disable sample labeling. Once a desired selection is made press the ENTER key.

“*Sample Labeling*” applies to the “Automatic Mode” only. It allows the user to assign a unique name to a sample which is then stored in the scales database. When set to “OFF” the scale will not assign or display names of the samples.

5. To assign a “*Quick Key*” use the navigation keys to select “*Quick Key*” and press the ENTER key. Use the navigation keys to select a desired quick key (F1 through F5). Once the desired key is selected press the ENTER key to accept the selection.

If the key is not available (used by a different function) a warning message will be displayed “*Warning Quick Key Already In Use!*” To override the key press ENTER. To abort and select a different function key press the CLR key.

6. To configure the scale’s display during parts counting use the navigation keys to select “*Display Setup*” and press the ENTER key. To disable information from displaying during the function use the navigation keys to highlight the desired selection and press the ENTER key to remove the check mark. Once the check mark has been removed the information will not display while performing parts counting.

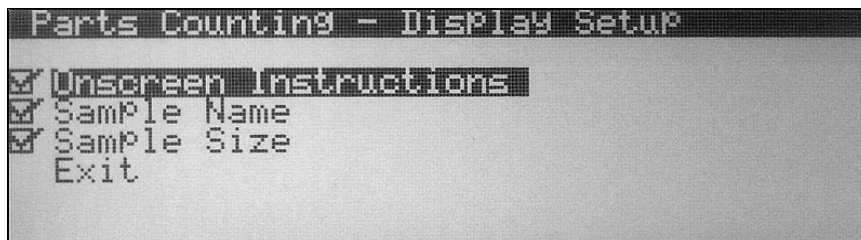

7. To exit Parts Counting set up use the navigation keys to select “*Exit*” and press ENTER.

### 8.1.3. Check Counting

- To configure the Check Counting Function, use the navigation keys to select “*Check Counting*” in “*Mode Setup*” and press ENTER. The status and available Check Counting options will be displayed. If the function is currently in use the status will be set to “*ON*”.

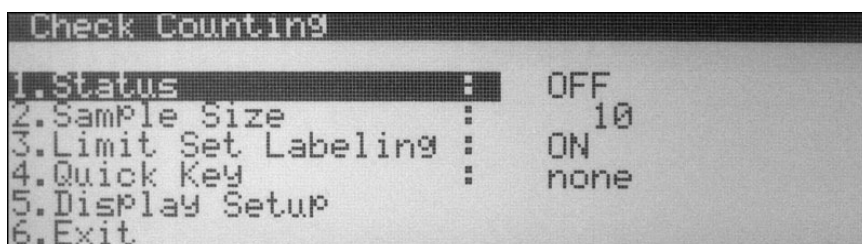
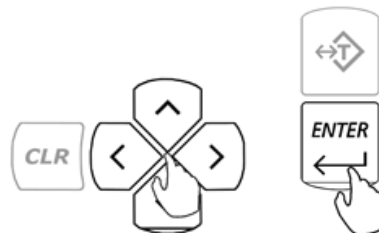

- To assign a default “*Sample Size*” that will be used in calculating the average piece weight use the navigation keys to select “*Sample Size*” and press ENTER. To select a preset “*Sample Size*” use the navigation keys to toggle until a desired sample size is displayed (1, 5, 10, 20, 50, 100, 200, 500). To assign a custom “*Sample Size*” use the number keys on the scale’s keypad to key in a desired value. Once the desired “*Sample Size*” is selected or entered press, the ENTER key to set and confirm the selection.
- To enable Limit Set Labeling use the navigation keys to select “*Limit Set Labeling*” and press the ENTER key. Use the navigation keys once again to enable or disable Limit Set labeling. Once a desired selection is made press the ENTER key.

“*Limit Set Labeling*” allows the user to assign a unique name to a Limit Set which is then stored in the scales database. When set to “*OFF*” the scale will not assign or display names of the Limit Set.

- To assign a “*Quick Key*” use the navigation keys to select “*Quick Key*” and press the ENTER key. Use the navigation keys to select a desired quick key (F1 through F5). Once the desired key is selected press the ENTER key to accept the selection.

If the key is not available (used by a different function) a warning message will be displayed “*Warning Quick Key Already In Use!*” To override the key press ENTER. To abort and select a different function key press the CLR key.



- To configure the scale’s display during check counting use the navigation keys to select “*Display Setup*” and press the ENTER key. To disable information from displaying during the function use the navigation keys to highlight the desired selection and press the ENTER key to remove the check mark. Once the check mark has been removed the information will not display while performing check counting.

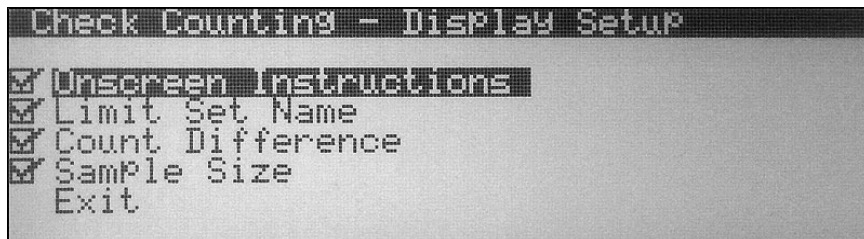

- To exit Check Counting set up use the navigation keys to select “*Exit*” and press ENTER.

### 8.1.4. Percent Weighing

- To configure the Percent Weighing Function, use the navigation keys to select “*Percent Weighing*” in “*Mode Setup*” and press ENTER. The status and available Percent Weighing options will be displayed. If the function is currently in use the status will be set to “*ON*”.

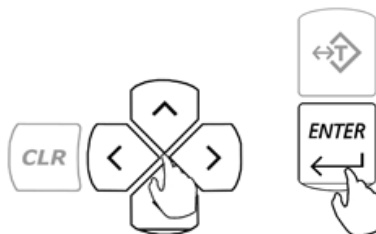
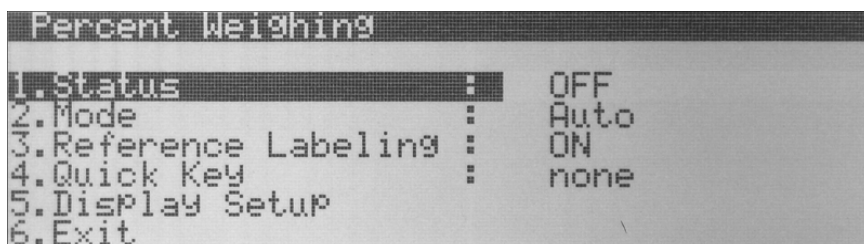
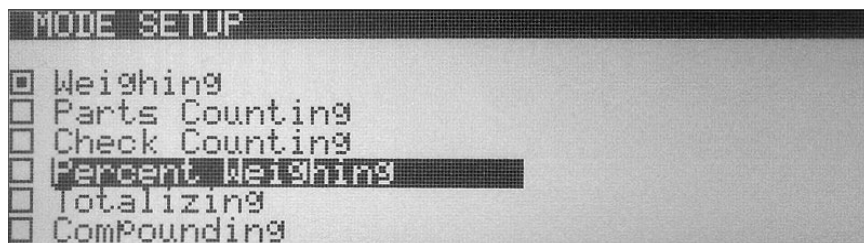

- To select an operating mode use the navigation keys to select “*Mode*” and press ENTER. By default Percent Weighing is set to “*Auto*” (Automatic). To operate Percent Weighing in manual use the navigation keys to select “*Manual*” and press ENTER.

<i>Percent Weighing Operating Modes</i>	
Automatic	When set to automatic the balance allows you to create a database of reference weights. Each reference weight can be labeled with a unique name or an alpha numeric code and stored in the scale's internal memory along with its weight representing 100%. This eliminates the need for establishing a new reference weights every time percent weighing is performed.
Manual	When using Percent Weighing in manual the database feature is disabled and reference weights are not stored in the scale's memory. A reference weight equaling 100% must be established every time Percent Weighing is performed.

- To enable Reference Weight Labeling use the navigation keys to select “*Reference Labeling*” and press the ENTER key. Use the navigation keys once again to enable or disable reference weight labeling. Once a desired selection is made press the ENTER key.

“*Reference Labeling*” applies to the “Automatic Mode” only. It allows the user to assign a unique name to a sample which is then stored in the scales database. When set to “*OFF*” the scale will not assign or display names of the reference weights.

- To assign a “*Quick Key*” use the navigation keys to select “*Quick Key*” and press the ENTER key. Use the navigation keys to select a desired quick key (F1 through F5). Once the desired key is selected press the ENTER key to accept the selection.

If the key is not available (used by a different function) a warning message will be displayed “*Warning Quick Key Already In Use!*” To override the key press ENTER. To abort and select a different function key press the CLR key.

- To configure the scale's display during percent weighing use the navigation keys to select “*Display Setup*” and press the ENTER key. To disable information from displaying during the function use the navigation keys to highlight the desired selection and press the ENTER key to remove the check mark. Once the check mark has been removed the information will not display while performing Percent weighing.



- To exit Percent Weighing set up use the navigation keys to select “*Exit*” and press ENTER.

### 8.1.5. Totalizing

1. To configure the Totalizing Function, use the navigation keys to select “*Totalizing*” in “*Mode Setup*” and press ENTER. The status and available Totalizing options will be displayed. If the function is currently in use the status will be set to “*ON*”.

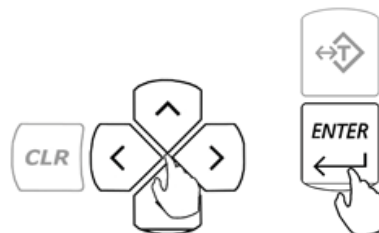
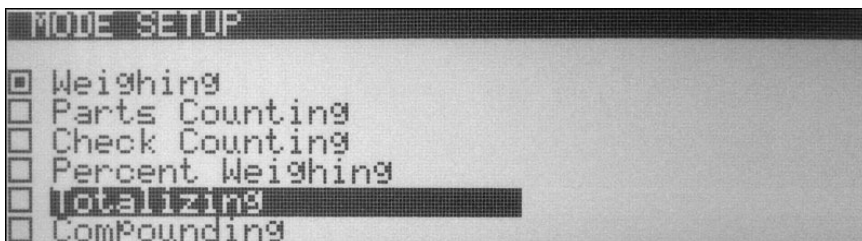

2. To select an operating mode use the navigation keys to select “*MODE*” and press ENTER. By default Totalizing is set to “*Auto*” (Automatic). To operate Totalizing in manual use the navigation keys to select “*Manual*” and press ENTER.

<i>Totalizing Operating Modes</i>		
Automatic	Totalizing and Adding : Automatic	When set to Automatic, the scale will automatically add the first stable weight reading to the total.
Manual	Totalizing and Adding : Manual	When set to Manual each weigh has to be manually added to the total by pressing a designated key.

3. To assign a “*Quick Key*” use the navigation keys to select “*Quick Key*” and press the ENTER key. Use the navigation keys to select a desired quick key (F1 through F5). Once the desired key is selected press the ENTER key to accept the selection.

If the key is not available (used by a different function) a warning message will be displayed “*Warning Quick Key Already In Use!*” To override the key press ENTER. To abort and select a different function key press the CLR key.

- To configure the scale's display during totalizing use the navigation keys to select "*Display Setup*" and press the ENTER key. To disable information from displaying during the function use the navigation keys to highlight the desired selection and press the ENTER key to remove the check mark. Once the check mark has been removed the information will not display while performing totalizing.

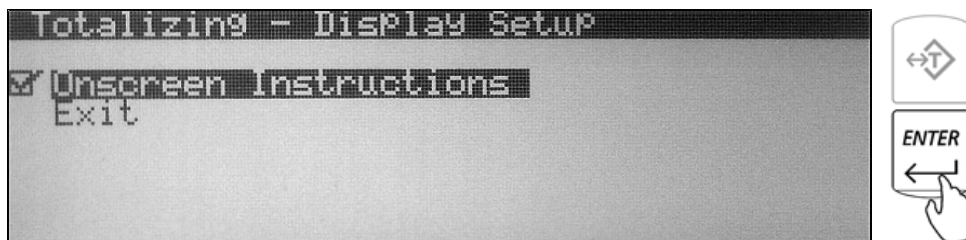

- To exit Totalizing set up use the navigation keys to select "*Exit*" and press ENTER.

### 8.1.6. Compounding

- To configure the Compounding Function, use the navigation keys to select "*Compounding*" in "*Mode Setup*" and press ENTER. The status and available Totalizing options will be displayed. If the function is currently in use the status will be set to "*ON*".

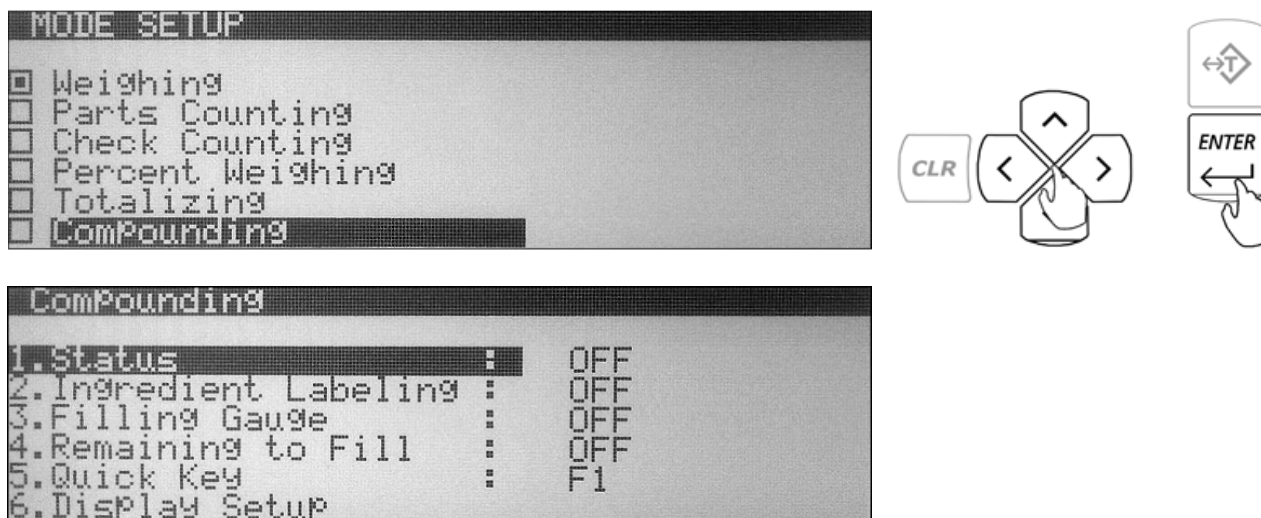

- To enable Ingredient Labeling use the navigation keys to select "*Ingredient Labeling*" and press the ENTER key. Use the navigation keys once again to enable or disable ingredient labeling. Once a desired selection is made press the ENTER key.
- To enable the Filling Gauge use the navigation keys to select "*Filling Gauge*" and press the ENTER key. Use the navigation keys once again to enable or disable the filling gauge feature. Once the desired selection is made press the ENTER key.
- To enable or disable the Remaining to Fill feature use the navigation keys to select the "*Remaining to Fill*" and press the ENTER key. Use the navigation keys once again to enable or disable the remaining to fill feature. Once the desired selection is made press the ENTER key.



5. To assign a “Quick Key” use the navigation keys to select “Quick Key” and press the ENTER key. Use the navigation keys to select a desired quick key (F1 through F5). Once the desired key is selected press the ENTER key to accept the selection.

If the key is not available (used by a different function) a warning message will be displayed “Warning Quick Key Already In Use!” To override the key press ENTER. To abort and select a different function key press the CLR key.

6. To configure the scale’s display during compounding use the navigation keys to select “Display Setup” and press the ENTER key. To disable information from displaying during the function use the navigation keys to highlight the desired selection and press the ENTER key to remove the check mark. Once the check mark has been removed the information will not display while performing compounding.

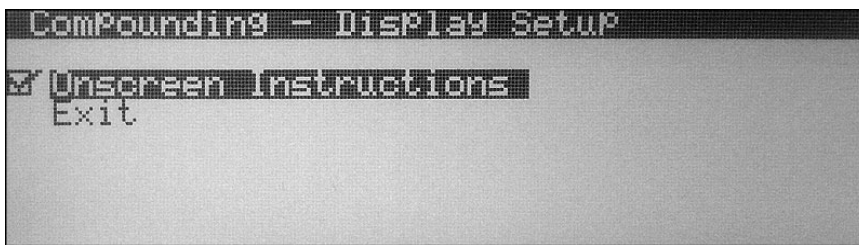

7. To exit Compounding set-up use the navigation keys to select “Exit” and press ENTER.

### 8.1.7. Check Weighing

1. To configure the Check Weighing Function, use the navigation keys to select “Check Weighing” in “Mode Setup” and press ENTER. The status and available Check Weighing options will be displayed. If the function is currently in use the status will be set to “ON”.

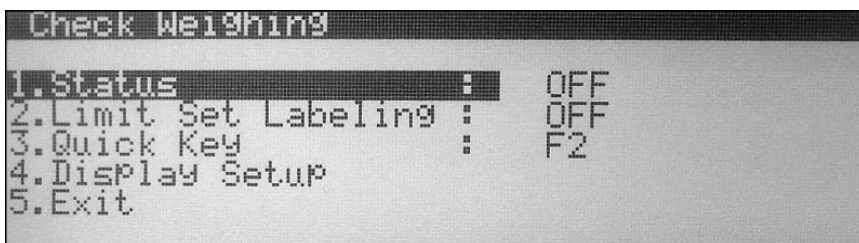
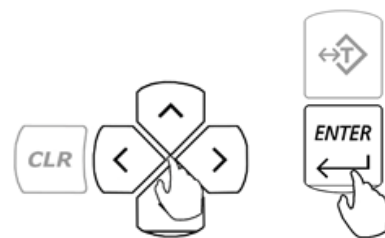
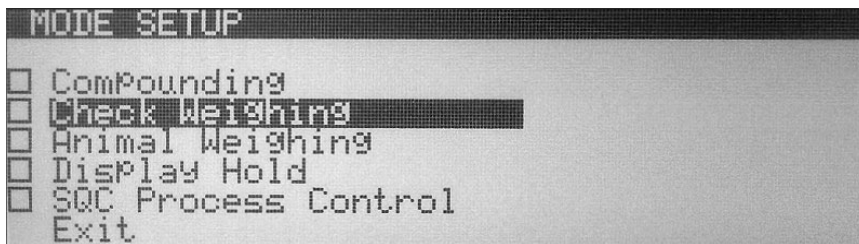



2. To enable Limit Set Labeling use the navigation keys to select “*Limit Set Labeling*” and press the ENTER key. Use the navigation keys once again to enable or disable Limit Set labeling. Once a desired selection is made press the ENTER key.

“*Limit Set Labeling*” allows the user to assign a unique name to a Limit Set which is then stored in the scales database. When set to “*OFF*” the scale will not assign or display names of the Limit Set.

3. To assign a “*Quick Key*” use the navigation keys to select “*Quick Key*” and press the ENTER key. Use the navigation keys to select a desired quick key (F1 through F5). Once the desired key is selected press the ENTER key to accept the selection.

If the key is not available (used by a different function) a warning message will be displayed “*Warning Quick Key Already In Use!*” To override the key press ENTER. To abort and select a different function key press the CLR key.

4. To configure the scale’s display during check weighing use the navigation keys to select “*Display Setup*” and press the ENTER key. To disable information from displaying during the function use the navigation keys to highlight the desired selection and press the ENTER key to remove the check mark. Once the check mark has been removed the information will not display while performing check weighing.

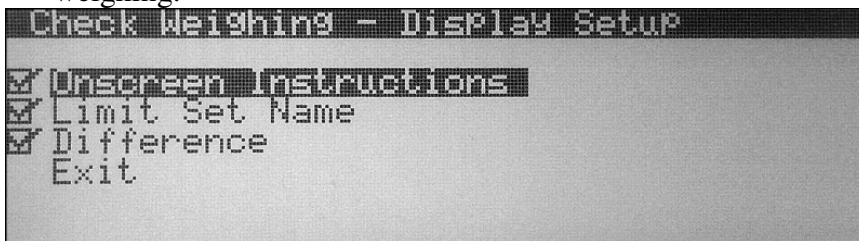

5. To exit Check Weighing set-up use the navigation keys to select “*Exit*” and press ENTER.

### 8.1.8. Animal and Dynamic Weighing

1. To configure the Animal and Dynamic Weighing Function, use the navigation keys to select “Animal Weighing” in “Mode Setup” and press ENTER. The status and available Animal Weighing options will be displayed. If the function is currently in use the status will be set to “ON”.

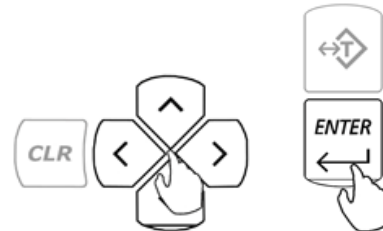
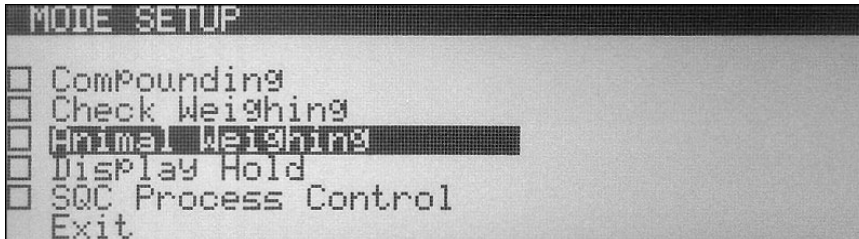

2. To select an operating mode use the navigation keys to select “Mode” and press ENTER. By default Animal Weighing is set to “Auto” (Automatic). To operate Animal Weighing in Semi-Automatic or Manual use the navigation keys to select a desired operating mode and press ENTER.

Animal Weighing Operating Modes		
Automatic	Weighing Initialization : Automatic Result Clearing : Automatic Tare : Automatic	When set to Automatic, the scale will automatically begin the animal weighing process. Once the animal is removed from the weighing pan, the scale will automatically tare and prepare for the next weighing.
Semi- Automatic	Weighing Initialization : Automatic Result Clearing : Manual Tare : Manual	When set to Automatic, the scale will automatically begin the animal weighing process. Once the animal is removed from the weighing pan, the result remains displayed until it is manually cleared. The scale must be manually tared before the next weighing.
Manual	Weighing Initialization : Manual Result Clearing : Manual Tare : Manual	When set to Manual, the animal weighing process must be manually initialized. Once the animal has been weighed and the pan cleared the result must be manually cleared. The scale must be manually tared before the next weighing.

3. To assign a default weighing time that will be used in calculating the weight dynamically, use the navigation keys to select “*Time*” and press ENTER. To select a “*Preset Time*” use the navigation keys to toggle until a desired Time is displayed (3sec., 5sec., 10sec., 15sec.). To assign a custom time use the number keys on the scale’s keypad to key in a desired value. Once the desired time is selected or entered, press the ENTER key to set and confirm the selection.
4. To assign a Quick Key to use the navigation keys to select “*Quick Key*” and press the ENTER key. Use the navigation keys to select a desired quick key (F1 through F5). Once the desired key is selected press the ENTER key to accept the selection.

If the key is not available (used by a different function) a warning message will be displayed “*Warning Quick Key Already In Use!*” To override the key press ENTER. To abort and select a different function key press the CLR key.

5. To configure the scale’s display during Animal Weighing use the navigation keys to select “*Display Setup*” and press the ENTER key. To disable information from displaying during the function use the navigation keys to highlight the desired selection and press the ENTER key to remove the check mark. Once the check mark has been removed the information will not display while performing animal weighing.

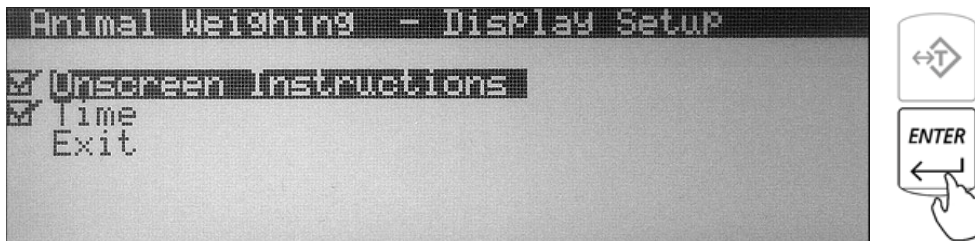

6. To exit Animal Weighing set-up use the navigation keys to select “*Exit*” and press ENTER.

### 8.1.9. Display Hold

- To configure the Display Hold Function, use the navigation keys to select “*Display Hold*” in “*Mode Setup*” and press ENTER. The status and available Display Hold options will be displayed. If the function is currently in use the status will be set to “*ON*”.

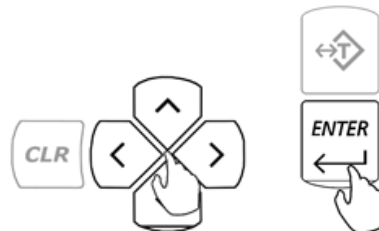
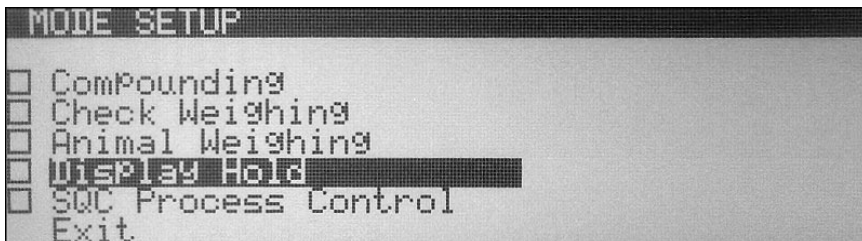

- To select an operating mode use the navigation keys to select “*Mode*” and press ENTER. By default Display Hold is set to “*Auto*” (Automatic). To operate Display Hold in Semi-Automatic or Manual use the navigation keys to select a desired operating mode and press ENTER.

<i>Display Hold Operating Modes</i>		
Automatic	Weighing Initialization : Automatic Result Clearing : Automatic Tare : Automatic	When set to Automatic, the scale will automatically lock and hold the first stable weight reading on the display. When the weight is removed the scale will automatically clear the result. Once the result is cleared the scale will automatically tare and prepare for next weighing.
Semi- Automatic	Weighing Initialization : Automatic Result Clearing : Manual Tare : Manual	When set to Semi-Automatic, the scale will automatically lock and hold the first stable weight reading on the display. When the weight is removed it must be manually cleared. Before starting the next weighing the scale must be manually tared.
Manual	Weighing Initialization : Manual Result Clearing : Manual Tare : Manual	When set to Manually, the first stable weight reading on the display must be locked manually. When the weight is removed it must be manually cleared. Before starting the next weighing the scale must be manually tared.



- To assign a “Quick Key” use the navigation keys to select “Quick Key” and press the ENTER key. Use the navigation keys to select a desired quick key (F1 through F5). Once the desired key is selected press the ENTER key to accept the selection.

If the key is not available (used by a different function) a warning message will be displayed “Warning Quick Key Already In Use!” To override the key press ENTER. To abort and select a different function key press the CLR key.

- To configure the scale’s display during display hold use the navigation keys to select “Display Setup” and press the ENTER key. To disable information from displaying during the function use the navigation keys to highlight the desired selection and press the ENTER key to remove the check mark. Once the check mark has been removed the information will not display while performing display hold.

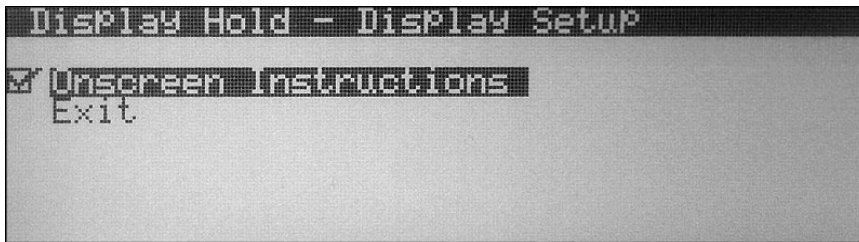

- To exit Display Hold set-up use the navigation keys to select “Exit” and press ENTER.

### 8.1.10. SQC Process Control

- To configure the SQC Process Control Function, use the navigation keys to select “SQC Process Control” in “Mode Setup” and press ENTER. The status and available check weighing options will be displayed. If the function is currently in use the status will be set to “ON”.

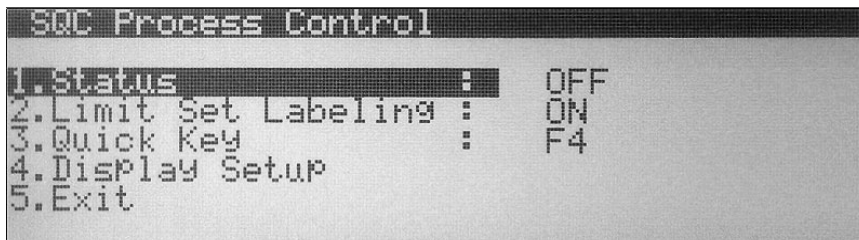
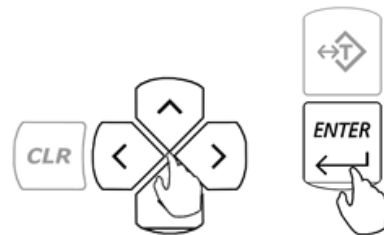
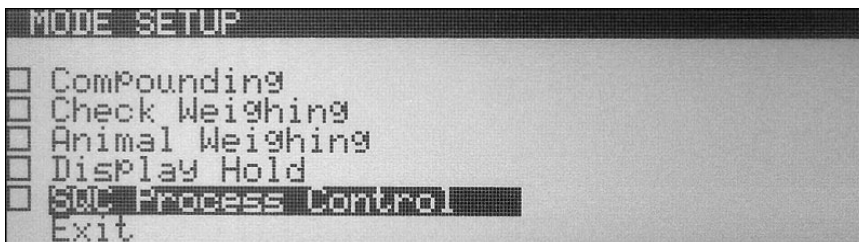

2. To enable Limit Set Labeling use the navigation keys to select “*Limit Set Labeling*” and press the ENTER key. Use the navigation keys once again to enable or disable limit set labeling. Once a desired selection is made press the ENTER key.

“*Limit Set Labeling*” allows the user to assign a unique name to a Limit Set which is then stored in the scales database. When set to “*OFF*” the scale will not assign or display names of the Limit Set.

3. To assign a “*Quick Key*” use the navigation keys to select “*Quick Key*” and press the ENTER key. Use the navigation keys to select a desired quick key (F1 through F5). Once the desired key is selected press the ENTER key to accept the selection.

If the key is not available (used by a different function) a warning message will be displayed “*Warning Quick Key Already In Use!*” To override the key press ENTER. To abort and select a different function key press the CLR key.

4. To configure the scale’s display during SQC Process Control use the navigation keys to select “*Display Setup*” and press the ENTER key. To disable information from displaying during the function use the navigation keys to highlight the desired selection and press the ENTER key to remove the check mark. Once the check mark has been removed the information will not display while performing SQC Process Control.

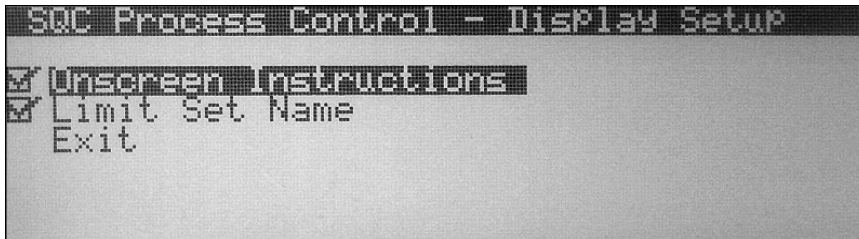

5. To exit SQC Process Control set-up use the navigation keys to select “*Exit*” and press ENTER.



### 8.1.11. Tare Setup

Depending on the application, as well as the function in use, the need to tare before weighing may not be required. By default tare is enabled and most functions require that a tare is performed. If the application does not require a tare before weighing, taring may be turned OFF or set to AUTO. To perform tare set-up follow the steps below.

1. Use the navigation keys to select “Tare Setup” in “Mode Setup” and press ENTER. The status of tare will be displayed.

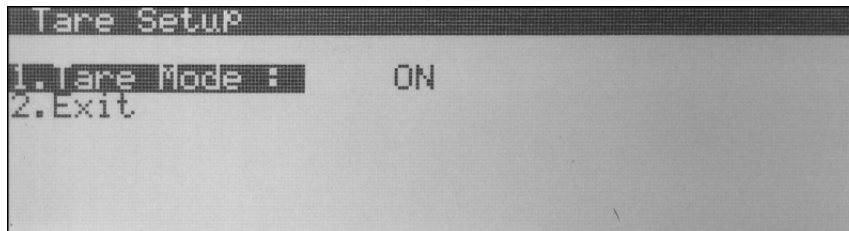
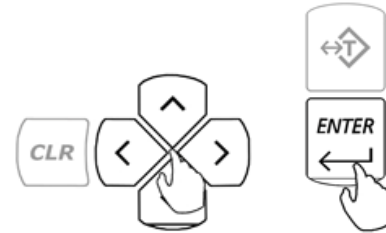
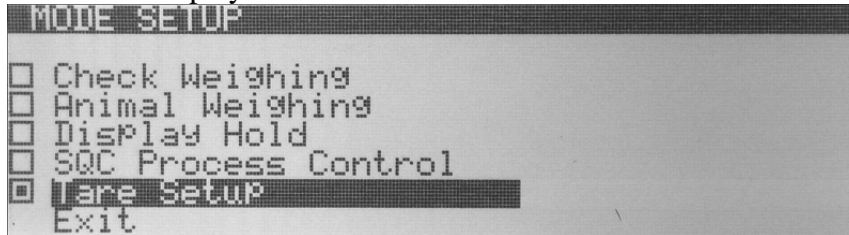

2. To enable, disable, or set tare to auto, select “Tare Mode” and press the ENTER key.
3. Use the navigation keys to make the desired selection and press the ENTER key to accept.

<i>Tare Setup Operating Modes</i>	
On:	When turned on most weighing function require that a tare is performed
Auto:	When set to Automatic most function prompt to perform a tare although the tare is performed automatically as soon as the weight of the container stabilizes.
Off:	When set to Off the function never prompts to perform a tare although a tare maybe performed by pressing the “T” Key.

## 8.2. Units of Measure

Torbal AG and AGN Scales can operate in ten different units of measure: grams (g), milligrams (mg), kilograms (kg), pounds (lb), ounce (oz), ounce-troy (ozt), carats (ct), penny weight (pwt), and grains (gn). By factory default the scale is set to weigh in grams (g). To select a different unit of measure follow the steps below:

1. From the Main Menu select “Units” and press the ENTER key. A list of available units of measure will be displayed. A check mark is displayed next to the unit of measure currently in use.

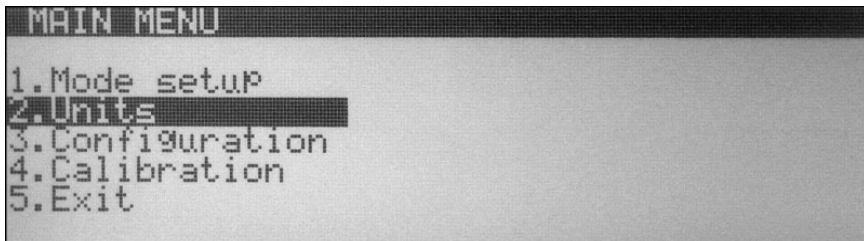

2. Use the navigation keys to select a desired unit of measure. Once the selection is made press the ENTER key to set and confirm the new unit of measure. The scale will automatically return to the weighing mode with the new unit selected.

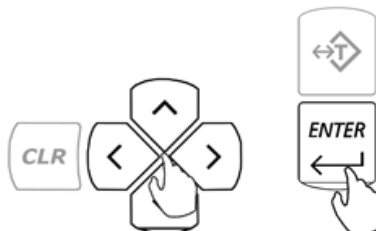
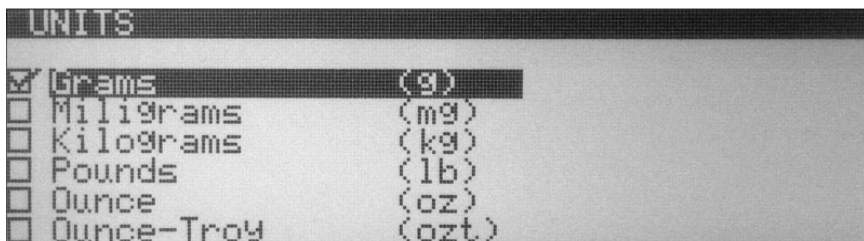

## 8.3. Configurations

The Configuration Menu allows you to configure scale's general settings and parameters.

1. From the Main Menu select “*Configuration*” and press the ENTER key. The configuration options will be displayed.

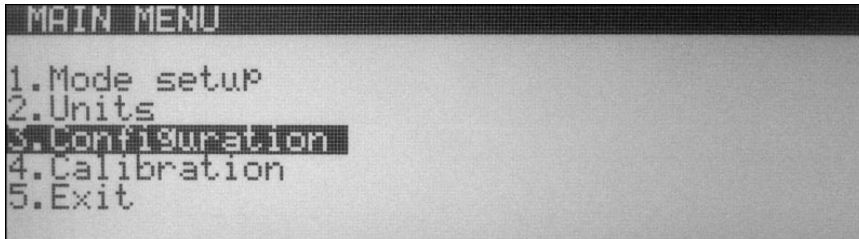

2. Use the navigation keys to select a desired option and press the ENTER key.

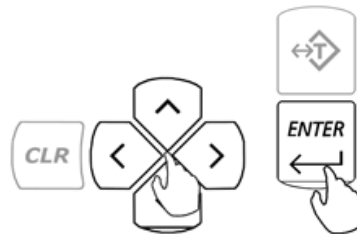
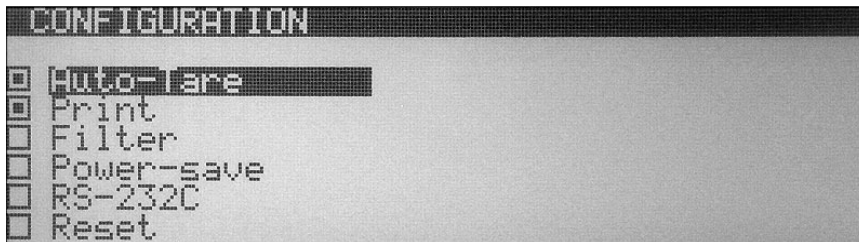

### 8.3.1. Auto-Zero

All AG/N Scales are equipped with AZSM, the “Auto Zero Setting Mechanism.” AZSM automatically maintains a center of zero between +/- 0.1d and 5.0d. To configure, enable, or disable AZSM follow the steps below. (Configuration is not available on Legal for Trade Models where AZSM is always on and set to 0.5d)

1. From the Configuration Menu select “*Auto-Zero*” and press the ENTER key.
2. To enable or disable Auto-Zero, select “*Status*” and press the ENTER key.

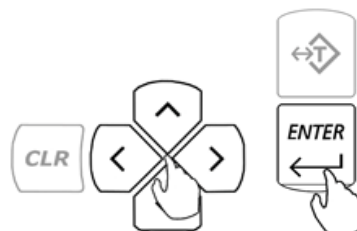
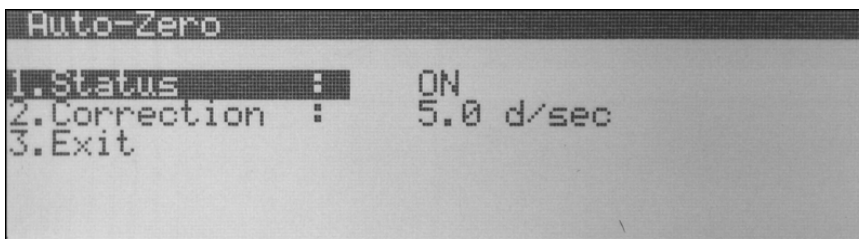

3. Use the navigation keys to set Auto Zero to “ON” or “OFF.”
4. Once desired selection has been made press the ENTER key.
5. To configure the Auto Zero correction parameter select “*Correction*” and press the ENTER key.
6. Use the scale’s numeric keys to key in the Auto-Zero correction value (from 0.1d to 5.0d). Once the value has been entered, press ENTER to accept.

### 8.3.2. Print

To configure, GLP printing parameters as well as printing details select “*Print*” from the Configuration Menu and press the ENTER key.

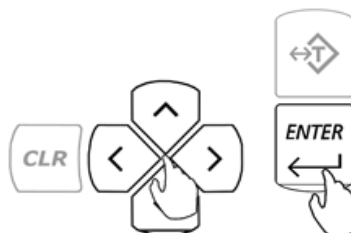

#### 8.3.2.1. GLP

To configure, enable, or disable GLP data follow the steps below.

1. From the Configuration Menu select “*Print*” and press the ENTER key.
2. To enable and configure GLP data use the navigation keys to select GLP and press the ENTER key.

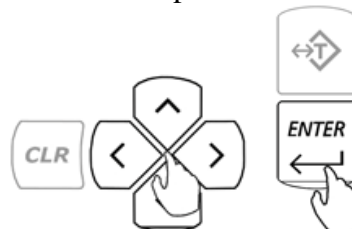
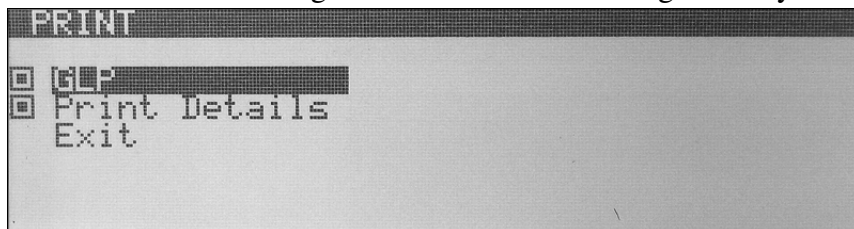

3. To enable desired GLP parameters use the navigation keys to make a selection and press the ENTER key to place or remove a check mark in order to enable or disable the parameter.

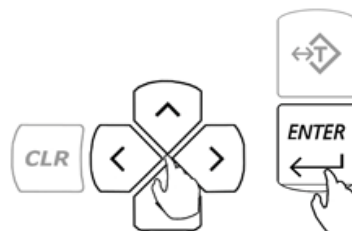
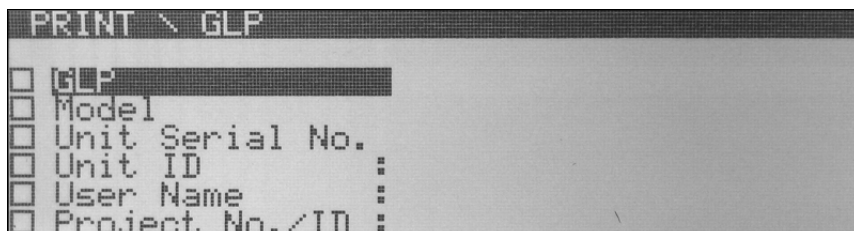

4. To key in parameter data such as “*unit id, user name, and project number*”, make the desired selection and press the right navigation key.
5. Once the right navigation key is pressed, use the scale’s alphabet or an external keyboard to key in the required data. Press ENTER to accept and save.

### 8.3.2.2. Print Details

To configure Print Set Up follow the steps below.

1. Select “*Print Details*” from the Print Menu and press the ENTER key.

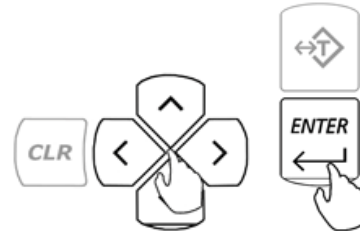
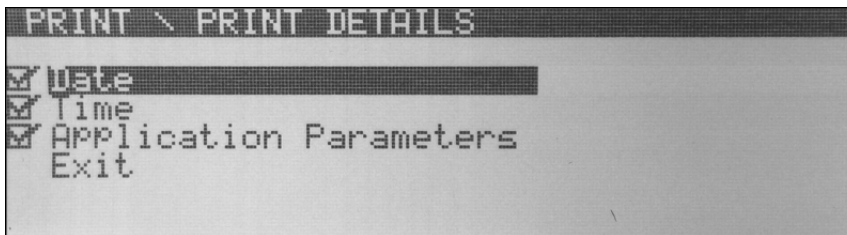

2. To enable or disable a desired printing detail use the navigation keys to make a desired selection and press the ENTER key to place or remove a check-mark in order to enable or disable the desired detail.

### 8.3.3. Filter

The filtering function allows the user to perform weighing in an environment where the scale may be exposed to drafts, frequent air movements, or vibrations. Lower Modes compensate for small disturbance and high modes compensate large disturbances. To select an appropriate filtering mode follow the steps below:

1. From the Configuration Menu select “*Filter*” and press the ENTER key.
2. Use the navigation keys to select “*Status*” and press the ENTER key.
3. Use the navigation keys to select a desired Mode and press the ENTER key to save the setting.



### 8.3.4. Power Save and LCD Contrast

1. From the Configuration Menu select “*Power Save*” and press the ENTER key.



2. To change the contrast of your LCD display, select “*Contrast*” and press the ENTER key.

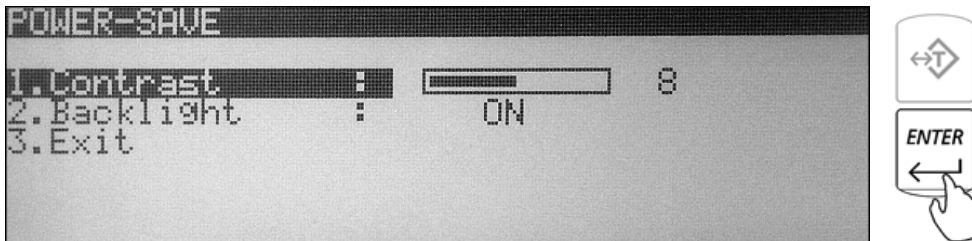

3. Using the left and right arrow navigation keys to adjust the contrast of your display. Once the contrast is at a desired level press the ENTER key to save the setting.
4. To turn off the back light of the LCD display, select “*Back Light*” and press the ENTER key.
5. Using the left and right arrow navigation keys select “*OFF*”. Once the back light is turned off press the ENTER key to save the setting.

### 8.3.5. RS232

1. From the Configuration Menu select RS-232C and press the ENTER key.

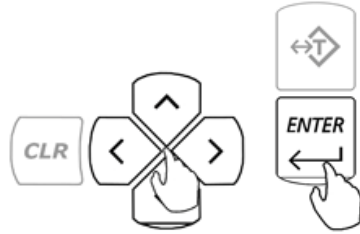
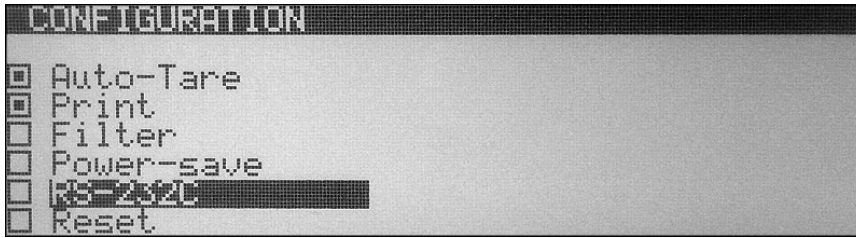

2. To configure the RS232 Port use the navigation keys to select a desired parameter and press the ENTER key.

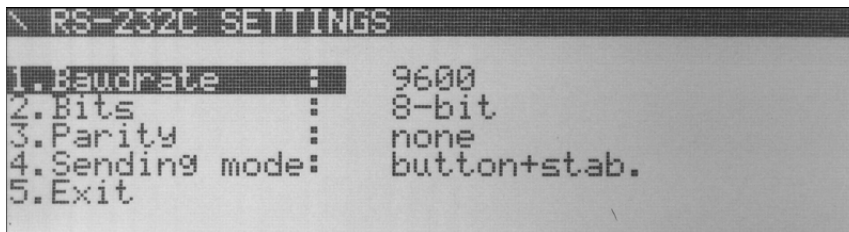

3. Use the navigation keys to make the desired selection and press the ENTER key to save the setting.

### 8.3.6. USB Configuration

1. From the Configuration Menu select USB and press the ENTER key.
2. To configure the USB Port use the navigation keys to select a desired parameter and press the ENTER key.
3. Use the navigation keys to make the desired selection and press the ENTER key to save the setting.

### 8.3.6.1. PC Connection via USB

Once the USB port has been configured, connect the scale to the PC with a Standard A/B USB cable and follow the “Found New Hardware” configuration wizard as described below.

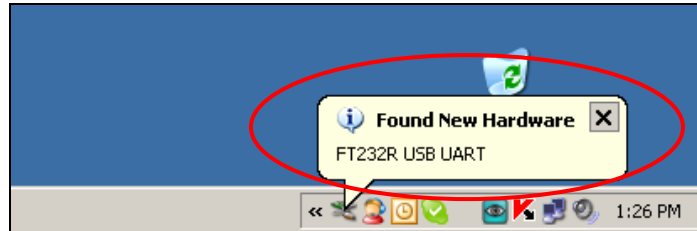

1. Allow Windows to connect to Windows Update in order to search for software. Select “*Yes, this time only*” and click “Next”. Once driver “FT232R USB UART” has been found, select “*Install the software automatically (Recommended)*” and click “Next”.

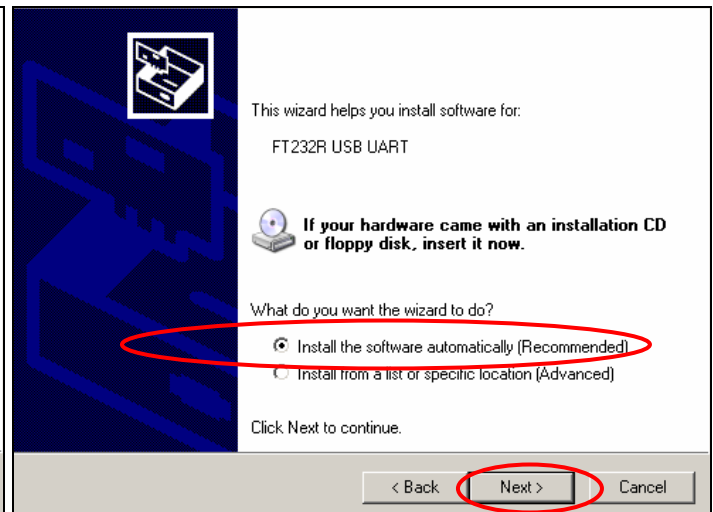
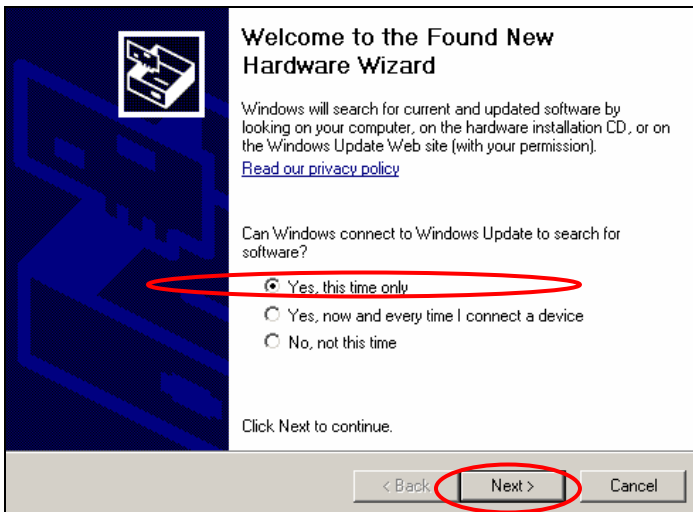

2. Windows will begin installation of the driver, when completed click “Finish”.

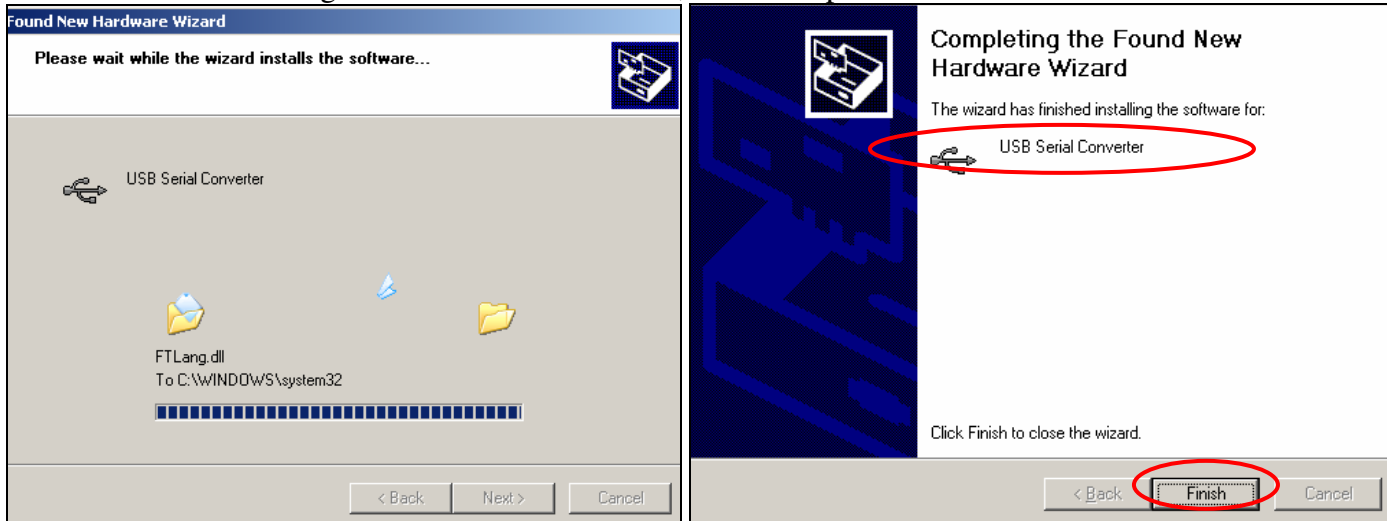

3. Once installation of the driver has been completed the scale is ready to communicate with the PC via the USB port.

### 8.3.7. Time and Date Adjustment

1. From the Configuration Menu select “Time and Date Adjustment” and press ENTER key.

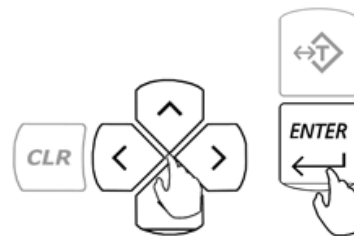
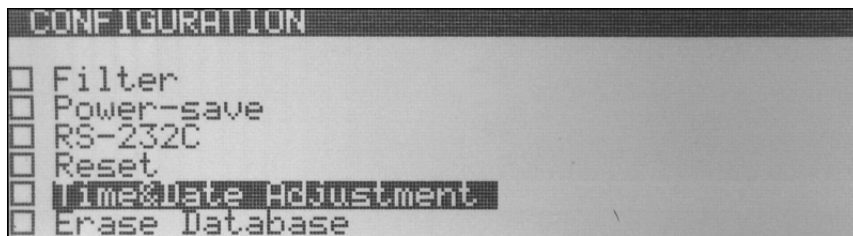

2. To adjust the time use the navigation keys to select “Time” and press ENTER.

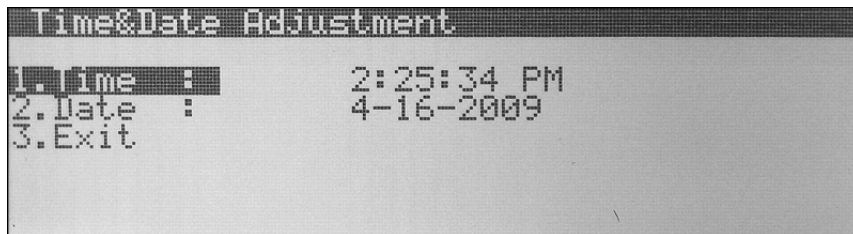

3. Use the yellow keys to enter the current time.

4. The time is entered in segments: Hours, Minutes, and Seconds. After entering a segment press the ENTER key to move to the next segment.

5. To change between AM and PM use the down arrow key and press the ENTER key.
6. To change the date select “Date” and press ENTER.
7. Use the yellow number keys to enter the current date. The date is entered in segments: Day, Month and Year 00/00/0000. After entering a segment press the ENTER key to move to the next segment.

### 8.3.8. Reset and Default Restore

1. From the Configuration Menu select “Reset” and press the ENTER key.

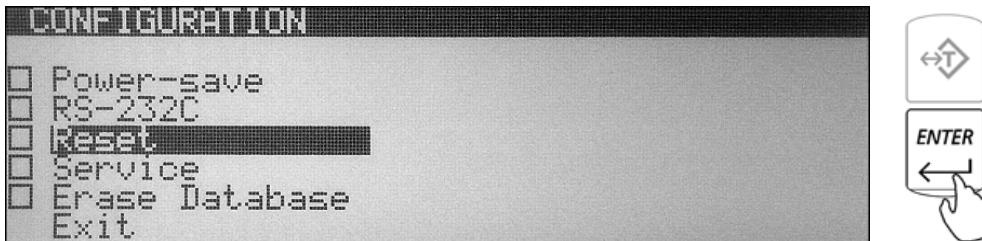

2. Command “Restore Default Settings? NO/YES” will be displayed.

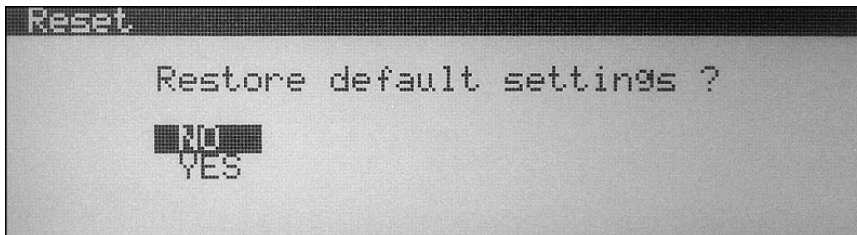

3. To restore default configuration settings use the arrow keys to select “YES” and press ENTER. The scale will restore default configuration settings and return to the Main Menu.

### 8.3.9. Erasing the Database

1. From the Configuration Menu select “Erase Database” and press the ENTER key.



2. The scale will display a warning indicating that all data will be erased. To confirm the erasure of the entire database using the navigation keys select “YES”, and press ENTER. To abort select “NO”.



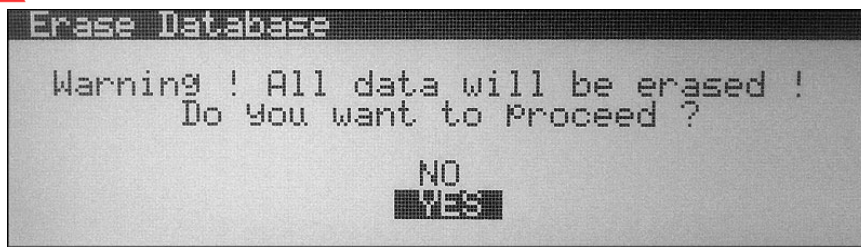

- The scale will now display second warning indicating that all data will be permanently lost. To abort using the navigation key select “NO”, or select “YES” to proceed and press ENTER.

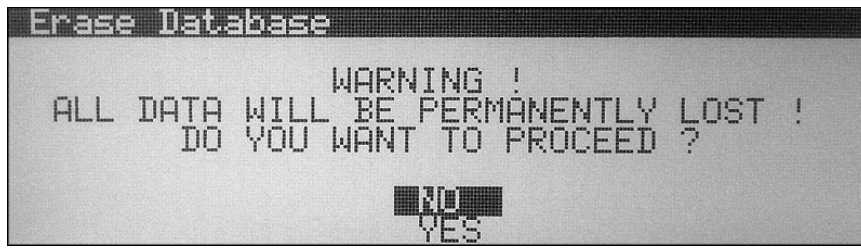

**WARNING:** Proceeding will result in formatting and erasing the entire memory bank. All data will be permanently lost.

- After proceeding with memory erasure the scale will begin to delete and format the entire database. This process lasts up to 45 seconds as the memory is formatted.

## 8.4. Calibration

The scale will automatically calibrate itself at start up. Calibration should be also performed periodically or whenever the scale is moved or relocated. To initiate internal calibration at anytime follow the steps below.

- Make sure the pan is free from any weight and press the calibration key (8).

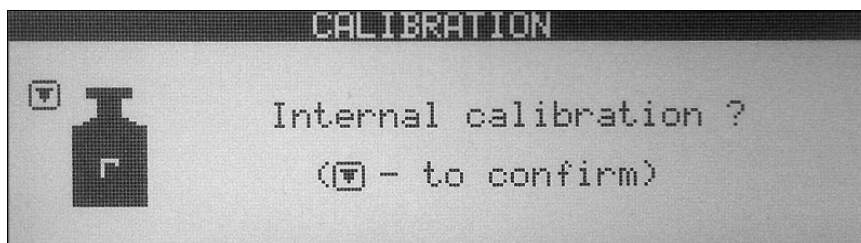

- The scale will display a command indicating to confirm internal calibration.
- In order to confirm internal calibration and proceed, press the calibration key again. The scale will begin internal calibration.

Calibration can last 30 to 50 seconds, when finished the scale will automatically return to the weighing mode.

### 8.4.1. Auto Calibration Setting and Adjustment

1. From Main Menu select “*Calibration*” and press the ENTER key. Available calibration options will be displayed.

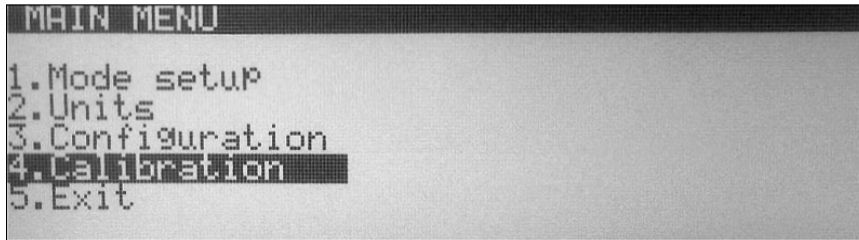

2. To adjust the internal calibration mass value with an external calibration weight that has a traceable class certification select “*External Calibration*” and press the ENTER key.
3. After pressing the ENTER key follow the prompts displayed on the LCD screen.
4. To use a calibration weight that is smaller than the scale’s capacity select external load and press ENTER, then use the navigation keys to select the desired load.
5. To disable automatic internal calibration use the navigation keys to select “*Status*” and press the ENTER key. Use the navigation keys once again to enable or disable automatic internal calibration. Once the desired selection is made press the ENTER key.

When disabled calibration will not initiate automatically, it can be performed only by initiating internal calibration with a calibration key.

6. Internal calibration can be configured to calibrate automatically with change of temperature. To set a calibration temperature intervals use the navigation keys to select “*Temperature*” and press the ENTER key. Use the navigation keys once again to select a desired temperature interval (none, 0.5C, 1C, 1.5C, 2.0C).

When set to none, automatic internal calibration will not initiate due to change in temperature.

7. Internal calibration can be also configured to calibrate automatically with change of time. To set a calibration time interval use the navigation keys to select “*Time*” and press the ENTER key. Use the navigation keys once again to select a desired time interval (none, 1h, 2h, 3h, 4h, 5h, 6h).
8. To exit the Calibration Menu, use the navigation keys to select “*Exit*” and press ENTER.

## Chapter 9: Using Functions and Modes

### 9.1. Weighing

1. To begin weighing, press the power button ( I/O ) to turn the scale ON. The scale will go through its initialization procedure and automatically enter “Weighing Mode”. The scale is ready to begin weighing as soon as the stabilization (  ) indicator appears on the display.

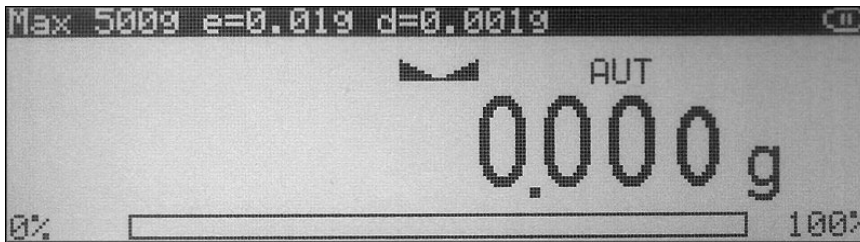

2. When weighing, always place the mass in the middle of the pan. The weighed result may be taken when the stabilization indicator appears on the display.

#### 9.1.1. Taring

1. If a container is used for weighing, it may be tared. In taring the container, the scale subtracts the weight of the container from the gross weight to obtain the net weight.



2. To tare the weighing container, place it in the middle of the pan. The container's weight will be shown on the display.

- Once the stabilization indicator appears on the display, the container is ready to be tared. To tare the container, press the “T” button. The display will show a dotted line which indicates the scale has begun the taring process.

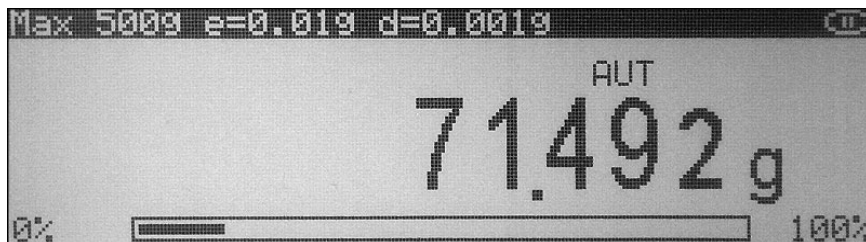

- When finished taring, the balance will return to “Weighing Mode”. The display will indicate 0.000(0)g.

### 9.1.2. Clearing a Tare

- To clear the tare, remove the tared object along with the NET weight from the pan. The scale will then display a negative result.

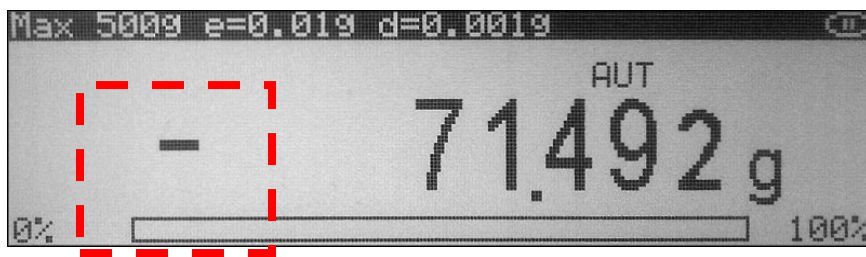

- To clear the tare, press the “T” button.
- The display will show dashed lines indicating the tare is clearing.
- When finished clearing the tare, the scale will return to Weighing Mode.



## 9.2. Parts Counting

### 9.2.1. Automatic

#### 9.2.1.1. Counting parts for the first time

1. Press the FUNCTION key to access the average piece weight database.



2. Use the navigation keys to select an “Empty Slot” into which the average piece weight will be saved.
3. Press the right navigation key to begin counting and average piece weight calculation.
4. If required, place a container on the pan and press the “T” key to tare.



5. After tarring the container the scale will display “Sample On” indicating to weigh the sample. Manually count out the sample size which was selected in mode set-up and place it in the container located on the pan.



The required sample size is also indicated in the upper left corner of the display (the SPL value).



- The weight of the sample will be displayed as it is placed on the pan.
- Once the weight of the sample stabilizes and the stability indicator appears on the display press the ENTER key to confirm the sample weight.

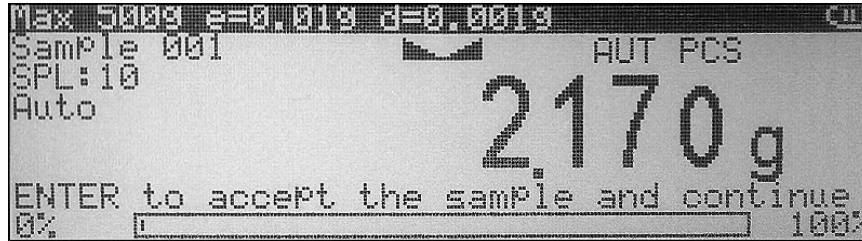

- If sample labeling has been enabled, "Sample Name" will be displayed indicating you should key in the name of the sample. To key in the name of the sample you may use the scale's alphabet (see chapter 10) or use an external keyboard (see chapter 6). Once the name has been entered press the ENTER key to accept the sample name.

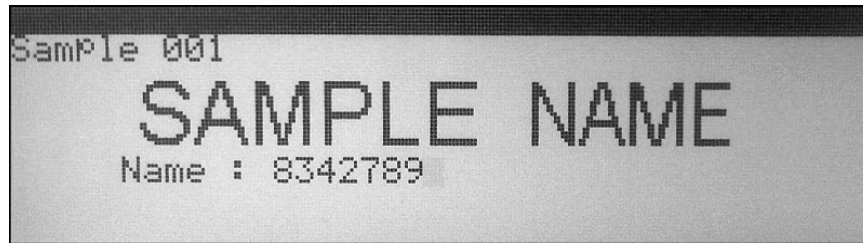

- The scale will store the sample in the internal memory and the display will indicate the count. At any time add the remaining pieces to perform parts counting.



- Once an accurate piece count has been taken the container and its content may be removed from the scale. To begin a new parts counting transaction press the CLR key.

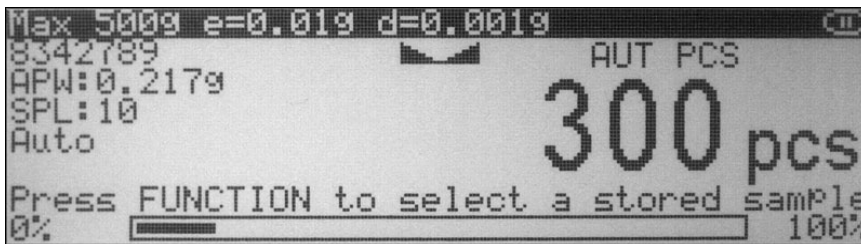

**9.2.1.2. Counting parts which have been previously stored in the scale’s database**

- If required, place a container on the pan and press the “T” key to tare.



- After tarring the container press the FUNCTION key to access the average piece weight database.

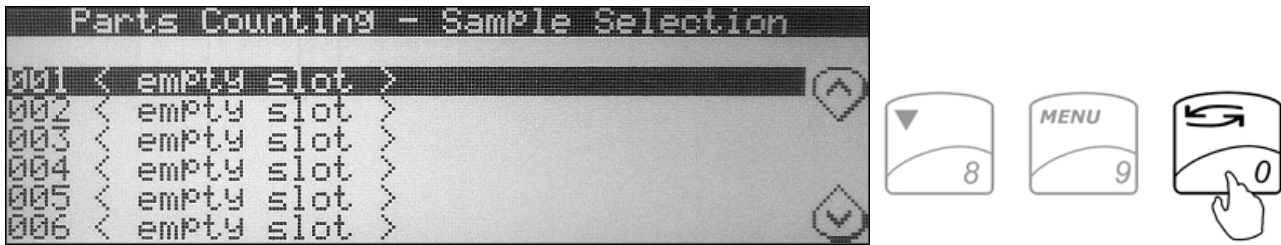

- Use the navigation keys to select a desired average piece weight and press the ENTER key to confirm your selection.
- "FILL" will appear on the display indicating to begin counting. At any time during the "FILL" command place the pieces into the container.



- Once an accurate piece count has been taken the container and its content may be removed from the scale. To begin a new parts counting transaction press the CLR key.

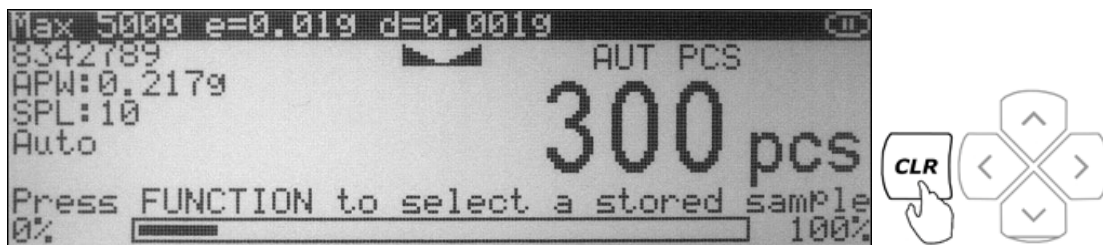



### 9.2.2. Manual

1. If required, place a container on the pan and press the “T” key to tare.



2. After tarring the container the scale will display “Sample On” indicating to weigh the sample. Manually count out the sample size which was selected in mode set-up and place it in the container located on the pan.



The required sample size is also indicated in the upper left corner of the display (the SPL value).

3. The weight of the sample will be displayed as it is placed on the pan.
4. Once the weight of the sample stabilizes and the stability indicator appears on the display press the ENTER key to confirm the sample weight.

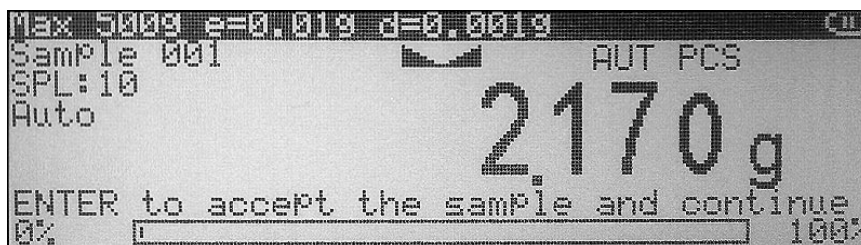

5. Display will indicate the count. At any time add the remaining pieces to perform parts counting.



6. Once an accurate piece count has been taken the container and its content may be removed from the scale. To begin a new parts counting transaction press the CLR key.



### 9.3. Check Counting

1. Press the FUNCTION key to access the limit set database.

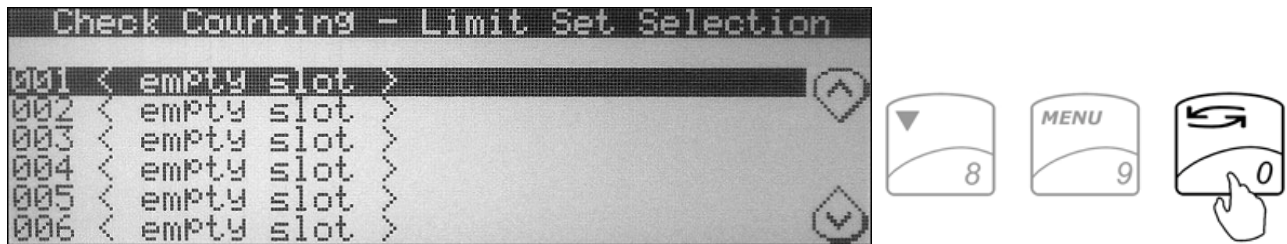

2. Use the navigation keys to select a "Desired Limit Set" and press the ENTER key to confirm your selection.



3. If required, place a container on the pan and press the “T” key to tare.



4. After tarring the container the scale will display “Sample On” indicating to weigh the sample. Manually count out the sample size which was selected in mode set up and place it in the container located on the pan.

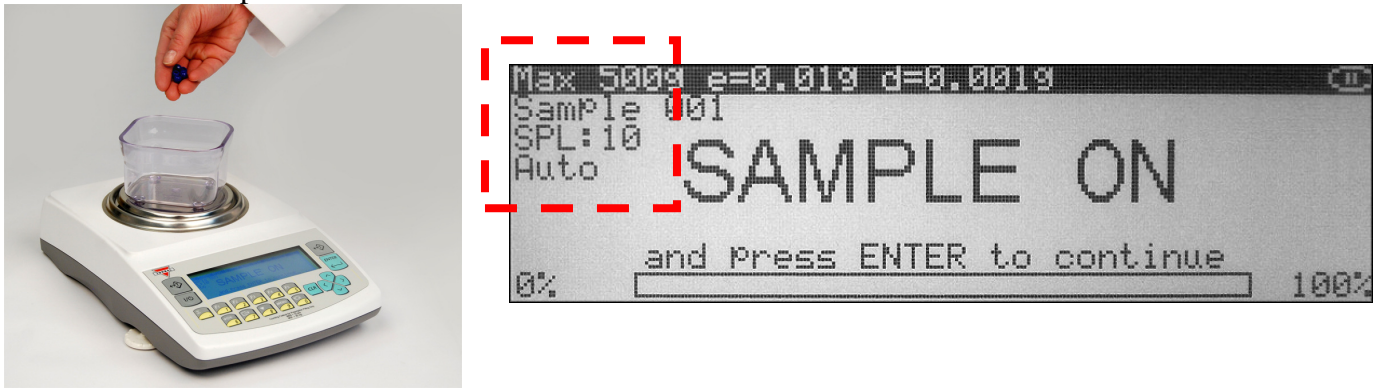

*The required sample size is also indicated in the upper left corner of the display (the SPL value).*

5. The weight of the sample will be displayed as it is placed on the pan.
6. Once the weight of the sample stabilizes and the stability indicator appears on the display press the ENTER key to confirm the sample weight.



- The display will indicate the numeric value of the sample. At any time add the remaining pieces to perform check counting.

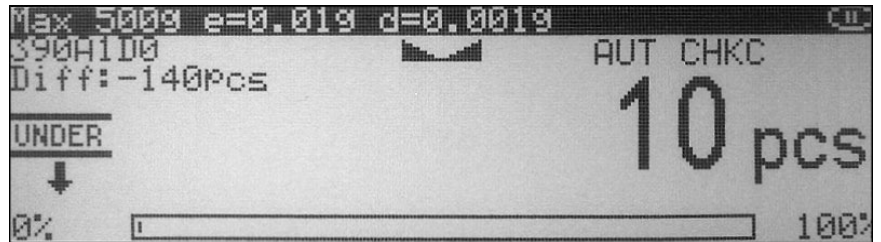

- As check counting is performed the display will indicate the actual count. If the count is less than the lower limit, the scale will display an “UNDER” command. If the count falls within the range, the “ACCEPT” command will be displayed. If the count exceeds the upper limit, the “OVER” command will be displayed.

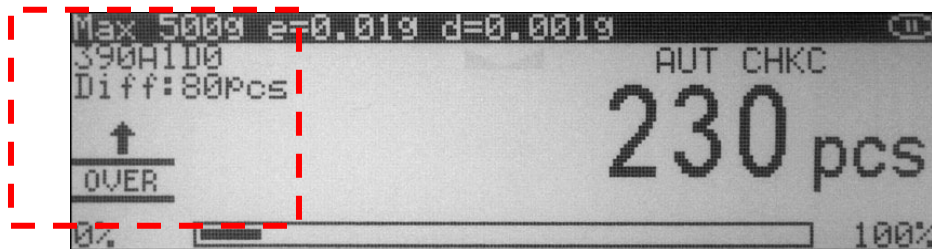
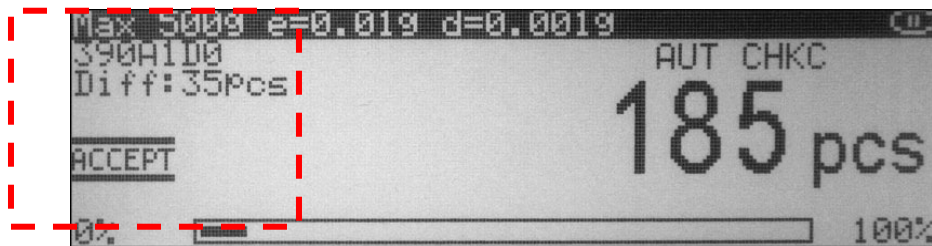

*The value indicating the difference between the actual count and the target point is displayed in the left upper corner of the display.*

- To begin a new check counting transaction, remove container and its content from the pan and press the CLR key.

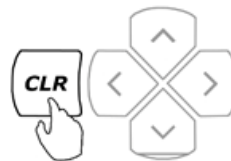
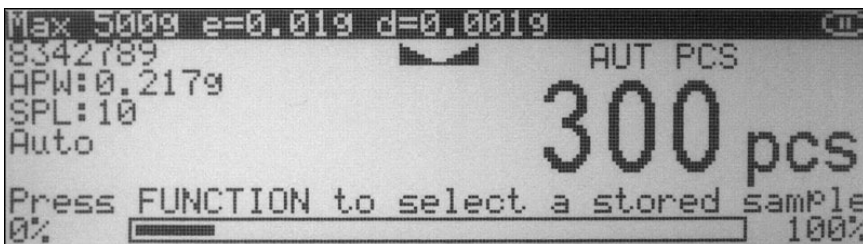

### 9.3.1. Storing a limit set into the scale’s database

1. Press the FUNCTION key to access the limit set database.

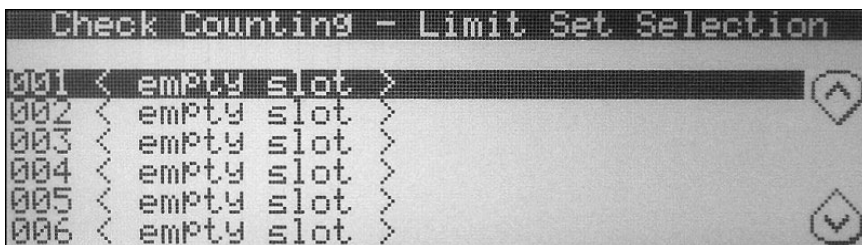

2. Use the navigation keys to select an “Empty Slot” into which the limit set will be saved.
3. Press the right navigation key. Available limit set fields will be displayed.

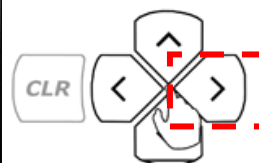
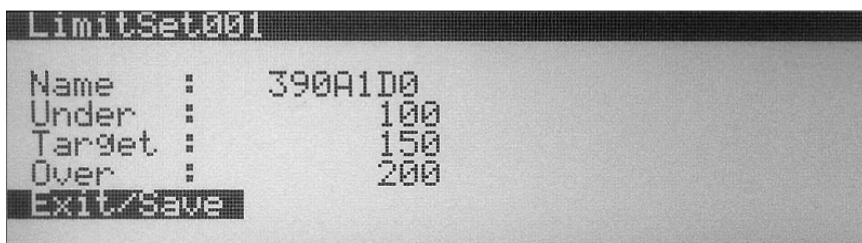

4. Use the navigation keys to select a desired field. Once the field is selected press the ENTER key and assign the desired criteria.
5. After assigning the limit set, select “Exit” and press the ENTER key to accept and save the set.

## 9.4. Percent Weighing

### 9.4.1. Automatic

#### 9.4.1.1. Percent weighing for the first time.

1. Press the FUNCTION key to access the reference weight database.



2. Use the navigation keys to select an “Empty Slot” in which the reference weight will be saved.
3. Press the right navigation key to store the reference weight and begin percent weighing.



- If required, place a container on the pan and press the “T” key to tare.



- After tarring the container the scale will display “Sample On” indicating to weigh the reference weight.

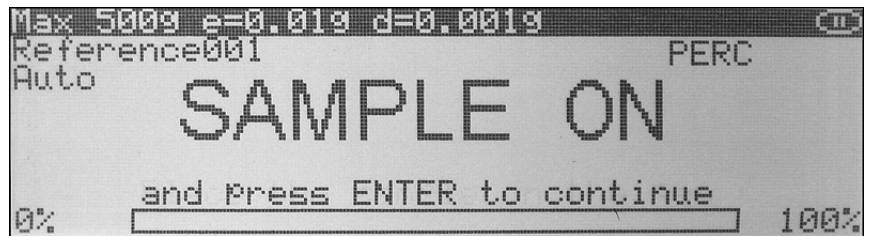

- The weight of the reference weight will be displayed as it is placed on the pan.

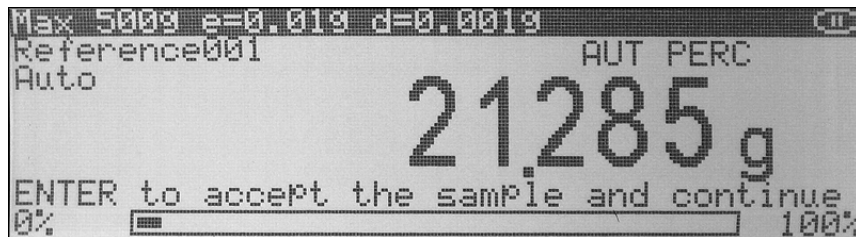

- Once the weight of the reference weight stabilizes and the stability indicator appears on the display press the ENTER Key to confirm the reference weight.

8. If reference labeling has been enabled, “*Reference Name*” will be displayed indicating you should key in the name of the reference. To key in the name of the reference weight you may use the scale’s alphabet (see chapter 10) or use an external keyboard (see chapter 6). Once the name has been entered, press the “ENTER” key to accept the reference name.



9. Once the reference weight has been accepted and named the scale will store the reference in the scale’s database and display “100%”.

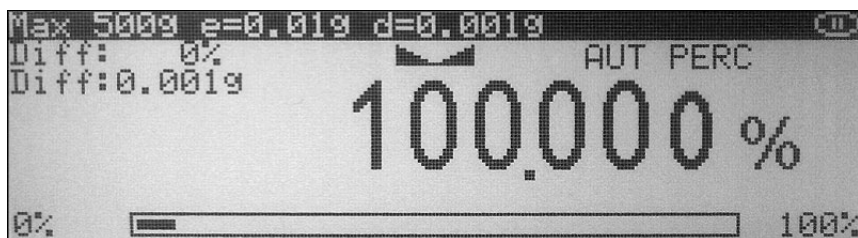

10. To perform percent weighing remove the reference weight and place an object on the pan. The scale will express the weight of the object as a percentage of the stored reference weight.

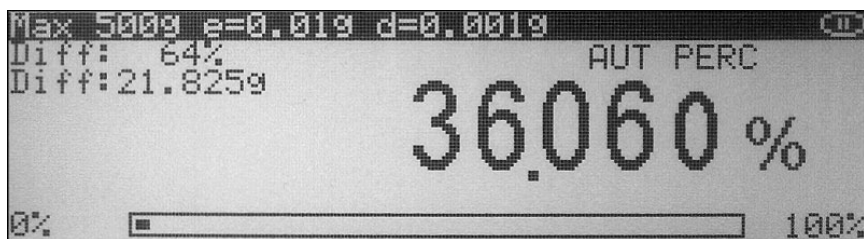



### 9.4.1.2. Percent weighing with stored reference weights

1. If required, place a container on the pan and press the “T” key to tare.



2. After tarring the container press the FUNCTION key to access the reference weight database.

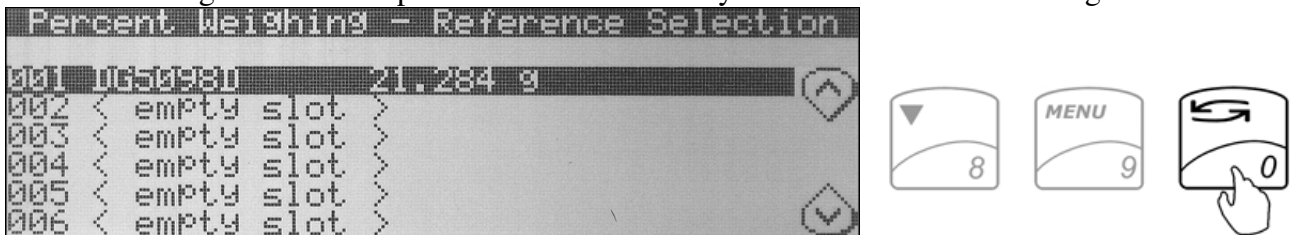

3. Use the navigation keys to select a desired reference weight and press the ENTER Key to confirm your selection.

4. The scale will display “0.000%” and the name as well as the reference weight will appear in the upper left corner of the display.

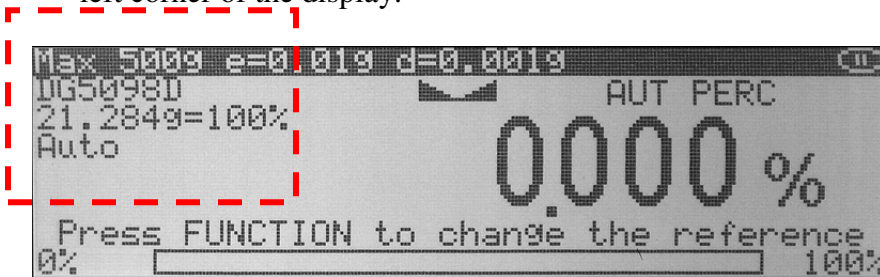

5. At any time place the object on the pan. The scale will express the weight of the object as a percentage of the selected reference weight.



## 9.4.2. Manual

1. If required, place a container on the pan and press the “T” key to tare.



2. After taring the container the scale will display “Sample On” indicating to weigh the reference weight.

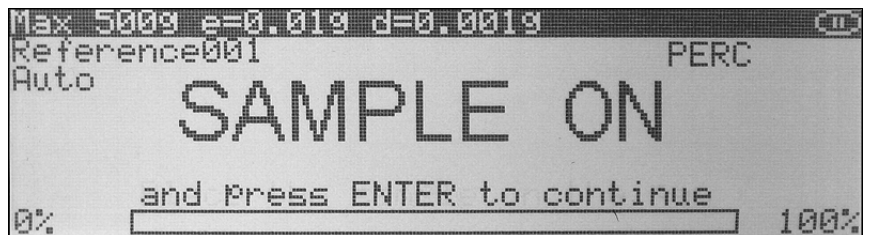

3. The weight of the reference weight will be displayed as it is placed on the pan.
4. Once the weight of the reference weight stabilizes and the stability indicator appears on the display press the ENTER key to confirm the reference weight.



- Once the reference weight has been accepted the scale will display “100%”.

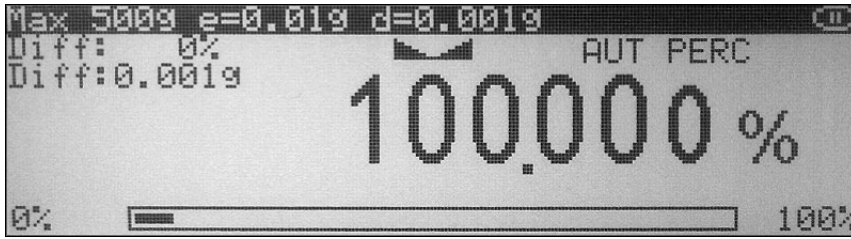

- To perform percent weighing remove the reference weight and place an object on the pan. The scale will express the weight of the object as a percentage of the reference weight.

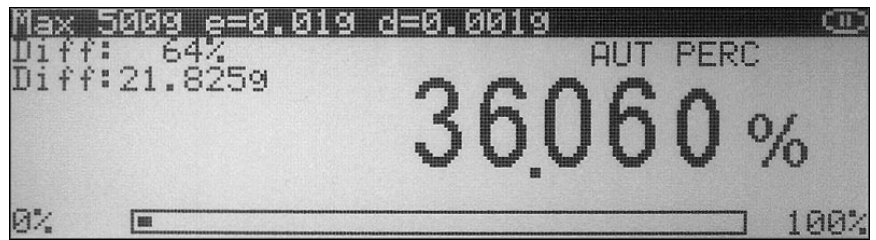

## 9.5. Totalizing

- If required, place a container on the pan and press “T” key to tare.



- After performing a tare place the first object on the pan.

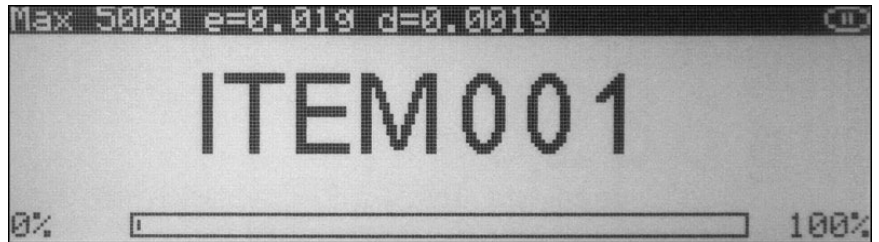

*Automatic:* When set to “Automatic” the weight of the object will be added automatically. Once the weight stabilizes, command “ITEM 00X” will appear on the display signaling that the weight has been added to the grand total.

Note: In the automatic mode the minimum weighing mass must be equal to or greater than 10d. To see this limit expressed in grams see specifications.

*Manual:* When set to “Manual” the weight of the object must be added manually. Once the weight stabilizes and the stability indicator appears on the display press the ENTER key to add the weight to the grand total. Upon pressing ENTER command “ITEM 00X” will appear on the display signaling that the weight has been added to the grand total.

- Once the weight has been added to the total you can remove the object from the pan and perform a tare if necessary.
- Steps one through three can be repeated to add more weighing results to the grand total.
- To view an itemized (Total Report) press the FUNCTION key.



- To print the report press F1. To clear and cancel Totalizing press F3. To continue Totalizing press F5.
- To cancel and start a new totalizing transaction presses the CLR key.

*Caution:* Pressing F3 will cancel and clear all items and totals.

## 9.6. Compounding

1. If required, place a container on the pan and press “T” key to tare.



2. If Ingredient Labeling has been enabled, the scale will indicate to name the ingredient. To key in the ingredient name you may use the scale's alphabet (Chapter 10) or an external keyboard (Chapter 6).

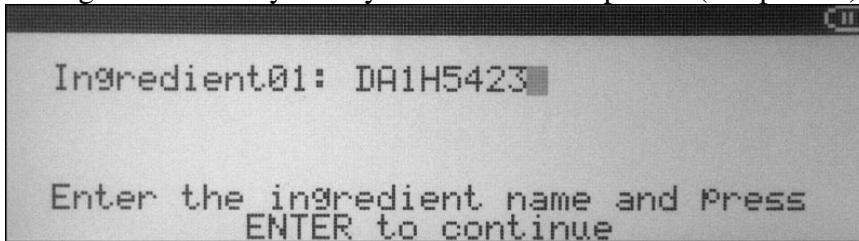

3. If the Remaining to Fill Feature is enabled, the scale will indicate to key in the weight of the ingredient to be weighed. Using the scale's keypad to key in the weight of the ingredient and press ENTER key.

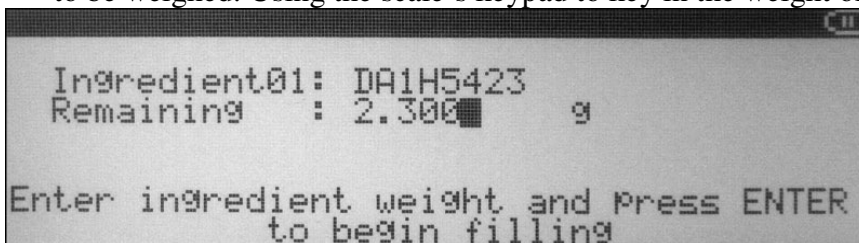



4. Once the information has been entered, the scale will indicate that you can begin adding the ingredient. Add the ingredient until the desired weight is displayed and the stability indicator appears on the display.



5. Once a desired weight is displayed press ENTER key to store the ingredient in the scale's memory.
6. Once the ingredient has been entered into the scale's memory, the scale is ready for the next ingredient. Repeat Steps 1 through 5 for each ingredient.

The ingredients are retained in the scale's memory until the recipe has either been completed or cleared (CLR). An ingredient can be removed from the pan; the scale can be tared if necessary before the next ingredient is added.

7. To view the recipe total, or to print and save recipes press the FUNCTION key.



## 9.7. Check Weighing

1. Press the FUNCTION key to access the limit set database.



2. Use the navigation keys to select a “Desired Limit” set and press the ENTER key to confirm your selection.
3. If required, place a container on the pan and press the “T” key to tare.



4. Place the object on the pan to check whether the weight of the object falls within the desired designated range. If the weight is less than the lower limit, the scale will display an “UNDER” command. If the weight falls within the range, the “ACCEPT” command will be displayed. If the weight exceeds the upper limit, the “OVER” commands will be displayed.

*The value (expressed in percent) indicating the difference between the actual weight and the target point is displayed in the left upper corner of the display.*

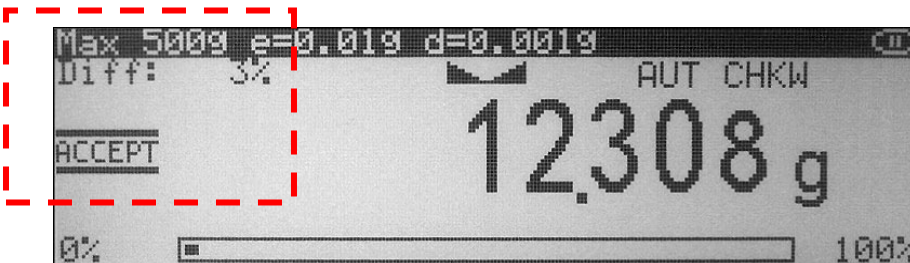

### 9.7.1. Storing a limit set into the scale's database

1. Press the FUNCTION key to access the limit set database.

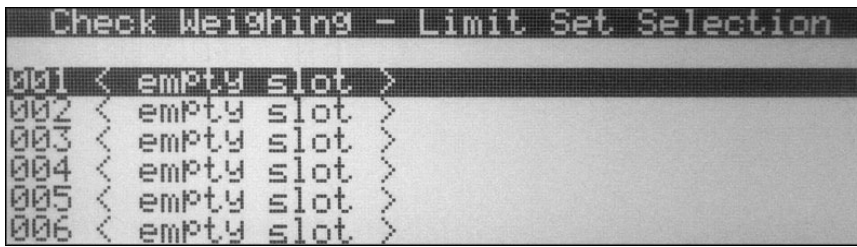

2. Use the navigation keys to select an "Empty Slot" into which the limit set will be saved.
3. Press the right navigation key. Available limit set fields will be displayed.

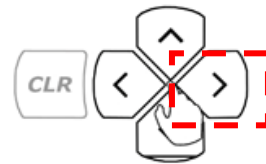
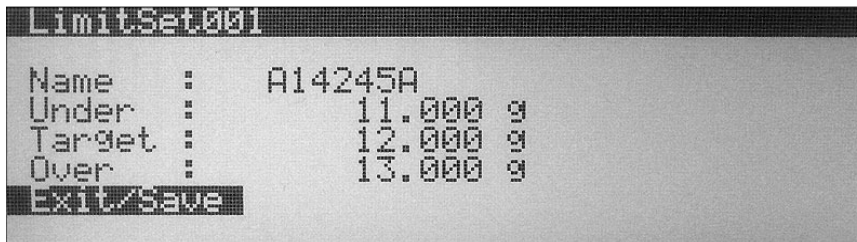

4. Use the navigation keys to select a desired field. Once the field is selected press the ENTER key and assign the desired criteria.
5. After assigning the limit set, select "Exit" and press the ENTER key to accept and save the set.



## 9.8. Animal and Dynamic Weighing

1. If required, place a container on the pan and press T key to tare.



2. Once the scale has been tared, command “ANIMAL ON” will be displayed. Carefully place the animal in the container.

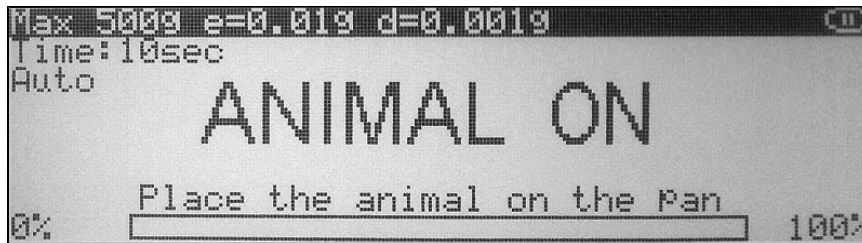

*Automatic and Semi-Automatic:* When set to “Automatic” and “Semi Automatic” the scale will automatically begin the animal weighing process. Animal weighing will begin with the first weight reading.

*Note:* In automatic and semi automatic modes the minimum weighing mass must be equal to or greater than 10d. To see this limit expressed in grams see specifications.

*Manual:* When set to “Manual”, animal weighing must be initialized manually by pressing the FUNCTION key.

3. Once the animal weighing process is initialized the scale will count down the time interval that was selected in mode set up. The countdown will be displayed. During the time interval the scale will record weight readings of the animal and calculate its average weight.

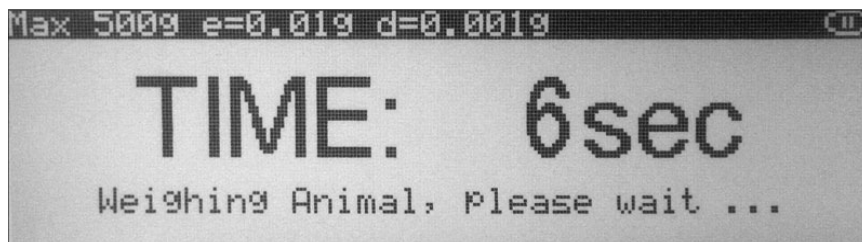

- After the time interval has elapsed the result will be displayed. The animal can now be removed from the pan.

*Automatic:* When set to “Automatic” the result will automatically be cleared after the animal is removed. The scale will perform an automatic tare and prepare for the next weighing.

*Semi-Automatic and Manual:* When set to semi automatic or manual the weighing result will remain displayed and it must be manually cleared after the animal has been removed. To clear the weighing result press the CLR key.

## 9.9. Display Hold

- If required, place a container on the pan and press “T” key to tare.



- After tarring container place the weight on the pan.
- Once the weight stabilizes and locks, the display will show a lock indicator.

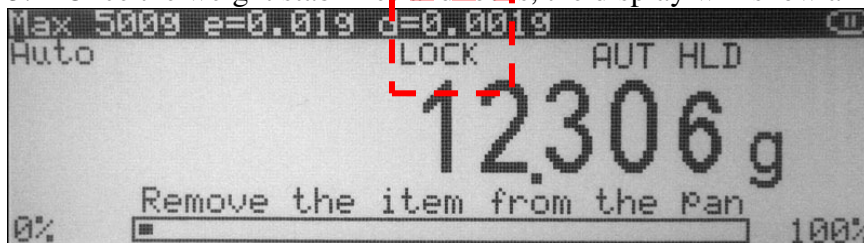

*Automatic and Semi-Automatic:* When set to “Automatic and Semi Automatic”, the scale will automatically lock the weighing result on the display as soon as it stabilizes.

Note: In automatic and semi automatic modes the minimum weighing mass must be equal to or greater than 10d. To see this limit expressed in grams see specifications.

*Manual:* When set to “Manual”, display hold is initialized by pressing the FUNCTION key.

- To clear the display in *Semi-Automatic* and *Manual* modes press the CLR key. In the *Automatic* mode the display will clear as soon as the weight is removed from the display.



### 9.10. SQC Process Control

1. Press the FUNCTION key to access the limit set database.

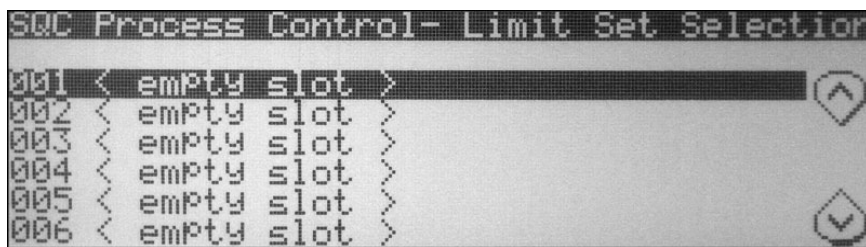

2. Use the navigation key to select the “Desired Limit Set” and press the ENTER key to confirm your selection.
3. If required, place a container on the pan and press the “T” key to tare.



4. Place the first sample on the pan. Once the weight stabilizes press the ENTER key to accept the weight of the sample.



Note: The number of required samples is displayed in the upper left corner of the display.

5. Remove the sample from the pan and weigh the next sample as required.
6. Repeat the steps until all samples are entered.
7. After entering the last sample an SQC Report will be displayed. To print the report press F1. To view statistical data such as standard and relative deviation, as well as min and max values press F3. To exit and start a new SQC Transaction press F5.

Note: Exiting the report will clear all data.



### 9.10.1. Storing a limit set into the scale's database

1. Press the FUNCTION key to access the limit set database.

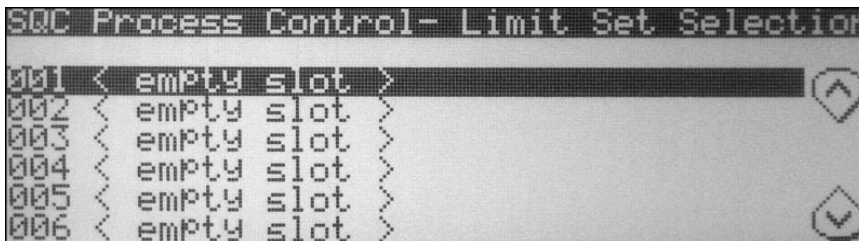

2. Use the navigation keys to select an "Empty Slot" into which the limit set will be saved.
3. Press the right navigation key. Available limit set fields will be displayed.
4. Use the navigation keys to select a desired field. Once the field is selected press the ENTER key and assign the desired criteria.

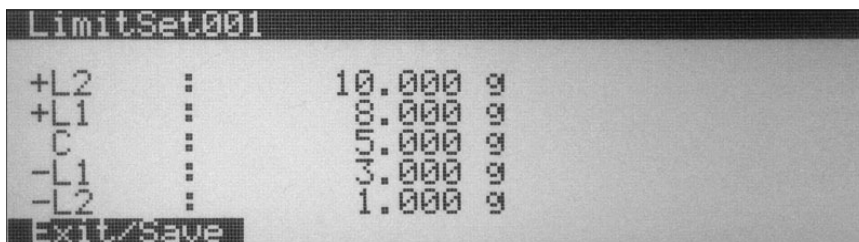

5. After assigning the limit set, select "Exit" and press the ENTER key to accept and save the set.

## Chapter 10: Using the scales alphabet

If an external PC Keyboard is not connected to the scale use the scale's keypad to enter letters of the alphabet and other characters. Each number key has an assigned set of characters and letters. Press the key until the desired letter or a character is displayed. Once selected, the scale will move to the next character automatically. For list of character and assigned numbers see the chart below.

Key	Characters
F1 / 1	1 . , ' ? ! " - ( ) / _ : ; + * = < > [ ] { }
F2 / 2	2 A B C a b c
F3 / 3	3 D E F d e f
F4 / 4	4 G H I g h i
F5 / 5	5 J K L j k l
→0← / 6	6 M N O m n o
⇨ / 7	7 P Q R S p q r s
▼ / 8	8 T U V t u v
Menu / 9	9 W X Y Z w x y z
⇄ / 0	0 double press for space

## Chapter 11: Connecting and Using a Barcode Scanner with the Scale's Database

A Barcode Scanner can be used to quickly recall samples or limit sets from the scale's database. To connect the barcode scanner to the scale use a PS/2 Keyboard Wedge Y-Cable Connector.

### 11.1. Connecting the scanner

1. Clear the pan and turn the scale off.
2. Locate the keyboard connection port at the rear of the scale, marked "Keyboard."
3. Insert the scanner's PS/2 Connector into the scale's port.

**Note:** Do not use an external power input with the scanner. Power will be supplied through the PS/2 Port.

### 11.2. Assigning barcodes to samples or limit sets

1. Select the function that will be used with your scanner and press the FUNCTION key.
2. Use the navigation keys to select a desired slot.
3. When asked to enter the name of your sample or limit set scan the barcode associated with the article.

The numeric code will appear in the name field. Some scanners will automatically form an "ENTER COMMAND". If a cursor is blinking at the end of your code press the ENTER key.

### 11.3. Recalling a previously stored sample or a limit set from the database

1. Press the FUNCTION key to access the scale's database. Stored limit sets or samples will be displayed.
2. Press the F1 key to search the database. A cursor will begin to blink at the top of the display. Scan the desired barcode to recall the desired sample or limit set.
3. If found the set will be highlighted on the display. Confirm the numeric code and press the ENTER key to continue.



# Chapter 12: Technical Information

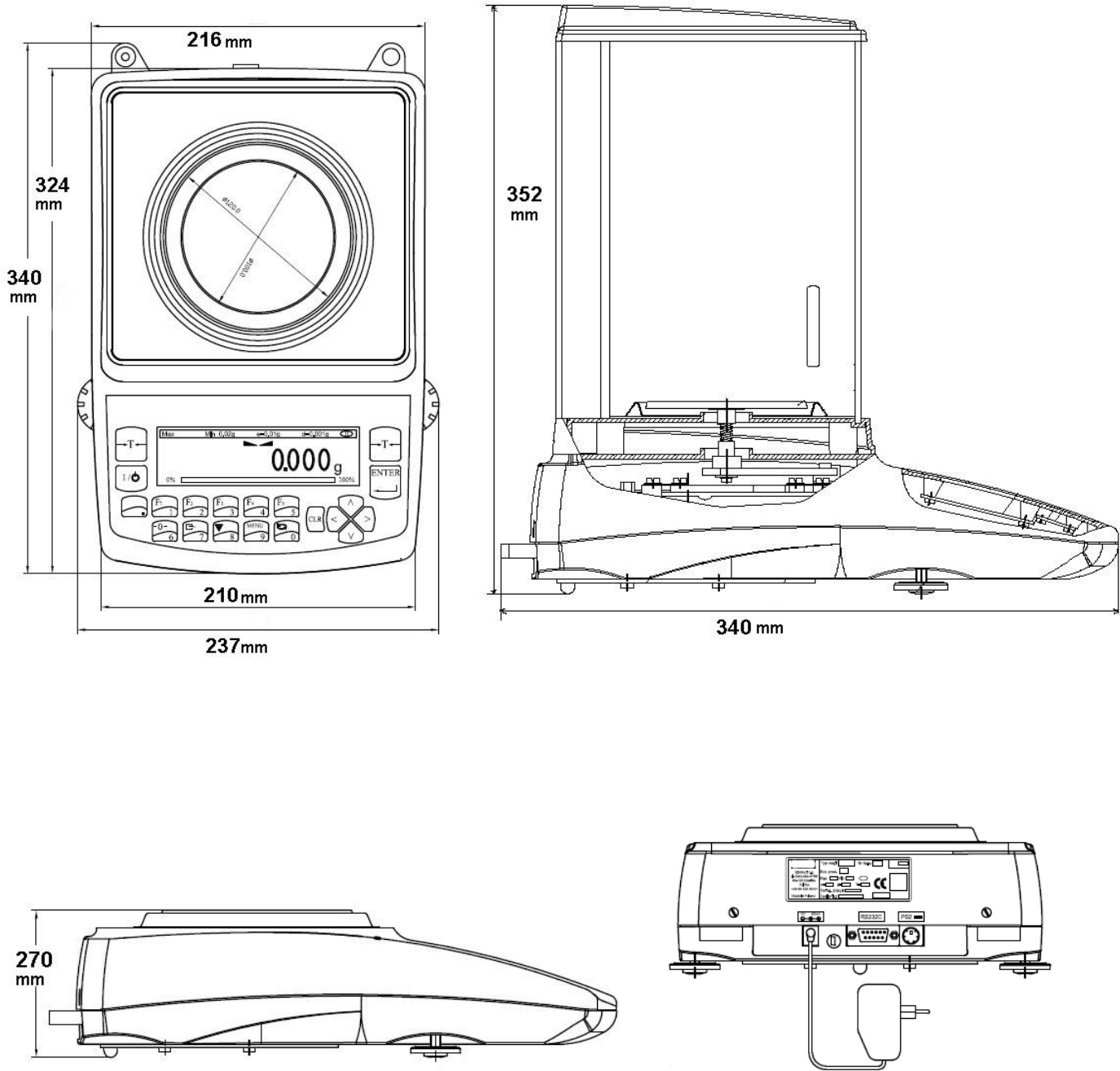

## Chapter 13: Common Error and Troubleshoots

Error	Cause	Explanation / Solution
<i>Load error!</i>	Scale load at start up exceeds 10% of the scale MAX capacity	The pan was not empty while the scale was initiating at startup. Clear the pan and restart the scale.
<i>Capacity exceeded!</i>	Scale range exceeded	The scale has exceeded its weighing capacity. Reduce the weight.
<i>Zero range exceeded!</i>	Attempt to zero the scale that is beyond the scale's Zero range	Reduce the weight to be zeroed and try again.
<i>Tare range exceeded!</i>	Attempt to tare the scale that is beyond the Tare range	Place a weight on a pan before taking a tare.
<i>Tare value not cleared!</i>	Attempt to zero the scale without clearing a prior tare	Remove weight from pan and clear store tare values.
<i>Unit weight too low!</i>	In Pill Counting Individual sample weight is less than 3e	Be sure that the individual piece weight is greater than 3e

<i>Load error! (C01)</i>	Load error while initializing. The pan mass is below 10% of the stored value.	Do not touch or move the scale while calibration is in progress. The pan MUST be empty and properly installed.
<i>Load error! (C02)</i>	Load error while initializing. The pan mass is over 10% of the stored value.	Do not touch or move the scale while calibration is in progress. The pan MUST be empty and properly installed.
<i>Load error! (C03)</i>	Load error while calibrating. The internal calibration mass is below 10% of the original stored mass.	Do not touch or move the scale while calibration is in progress. The pan MUST be empty and properly installed.
<i>Load error! (C04)</i>	Load error while calibrating. The internal calibration mass is over 10% of the original stored mass.	Do not touch or move the scale while calibration is in progress. The pan MUST be empty and properly installed.
<i>Load error! (C05)</i>	Load error while performing second tare during calibration. Mass of the pan is less by more than 1e from the first stored value.	Do not touch or move the scale while calibration is in progress. The pan MUST be empty and properly installed.
<i>Load error! (C06)</i>	Load error while performing second tare during calibration. Mass of the pan is over by more than 1e from the first stored value.	Do not touch or move the scale while calibration is in progress. The pan MUST be empty and properly installed.
<i>Load error! (C07)</i>	Load error during second calibration. The difference on the internal calibration mass from the first to the second calibration is more than 1e.	Do not touch or move the scale while calibration is in progress. The pan MUST be empty and properly installed.
<i>No external calibration! (C08)</i>	Initial internal calibration test not permitted without prior external calibration	Contact Technical Support
<i>Calibration failure! (C09)</i>	Internal calibration failed because of timeout in final calibration stage (timeout in 30 seconds without stabilization)	Contact Technical Support

If any of the following errors are displayed, please contact technical support at (973)-473-6900

<i>EEPROM1 Error</i>	EEPROM1 memory error (shortage of memory, memory is damaged, or check sum error)
<i>EEPROM2 Error</i>	EEPROM2 memory error (shortage of memory, memory is damaged, or check sum error)
<i>EEPROM Error!</i>	EEPROM1 or EEPROM2 memory error
<i>CRC Error xx</i>	Check sum error number xx in EEPROM memory
<i>Service switch OFF!</i>	Attempt to access the Service mode with the Service Switch in the OFF position
<i>A/D range exceeded!</i>	A/D converter range exceeded
<i>A/D converter read error!</i>	No response from A/D converter
<i>Temperature sensor error!</i>	No response from the temperature sensor
<i>Service switch ON!</i>	Attempt to access the Service Mode without a service command

## Chapter 14: Maintenance

### Cleaning and maintaining your Prescription Scale:

- Before cleaning the scale always unplug the A/C adapter from the electrical outlet.
- Use a soft, slightly damp cloth to clean the exterior housing of your scale,.
- Wipe the scale gently. Do not allow any liquid to enter into the scale.
- Do not apply extensive pressure to the LCD display.
- Do not use chemicals or benzene when cleaning the surface. Corrosive chemicals may damage the finish.
- Alcohol may be used only to clean the scale's stainless steel pan or the draft ring.

## Chapter 15: Accessories

Description	Part No.
Draft Shield Cover	301055
RXP-4 Thermal Printer	301060
RS232 PC Cable	301057

## Chapter 16: Replacement Parts

Description	Part No.
A/C Adapter	301053
Pan Assembly	301067
RS232 Printer Cable	201057

## Chapter 17: Limited Warranty

### PURCHASER'S 24-MONTH WARRANTY

Warranty is valid only if the attached warranty registration card is completed and returned within 30 days.

This product is a precision device made to exacting standards of scientific accuracy. It is guaranteed to have been adjusted and inspected for proper workmanship and performance, and certified for its currently advertised specifications before shipment.

Fulcrum Products are warranted against defects in material and workmanship under normal use and service. This warranty is extended only to the first purchaser. This limited warranty will not apply if, upon inspection, it is found that the product was tampered with, misused, overloaded, or abused, mishandled, placed in an improper environment, improperly installed or adjusted, used for a purpose other than that for which it was designed, or repaired by unauthorized personnel.

Fulcrum's liability under this warranty is limited to furnishing labor and parts necessary to remedy the defect covered by this warranty and restore the product to normal operating condition. Purchasers may be charged a minimum repair fee for in-warranty products returned for repair if those products are determined to be problem-free.

To make a claim under this limited warranty, obtain an RMA number from Fulcrum and return the product, carefully packed in its original packaging, shipping prepaid, with the RMA number written on the return package.