



Since 1887

SI Division of
Scientific Industries, Inc.



Instruction Manual: AD Series

Table of Contents

Chapter 1: Cautionary Notes and Warnings	1
Chapter 2: Specifications	3
Chapter 3: Parts Description	4
Chapter 4: Keys, Display Indicators and Commands.....	6
Chapter 5: Unpacking the Scale and Getting Started	8
Chapter 6: Main Menu	10
Chapter 7: Calibration (CALIB)	11
7.1 Calibration – External:.....	11
Chapter 8: Units of Measure Selection (Units) Not Legal for Trade models only.....	14
Chapter 9: Mode Configuration (MODE)	15
9.1 Animal Weighing Configuration	16
9.2 Parts Counting Configuration	18
9.3 Check Weighing Configuration.....	19
9.4 Display Hold Configuration	21
9.5 Percent Weighing Configuration.....	22
9.6 Totalizing Configuration	23
Chapter 10: Auto Zero Setting Mechanism – AZSM (AZSM).....	24
Chapter 11: GLP Print and Data Configuration (GLP)	25
Chapter 12: Printing Data and Communication Ports (PORTS).....	28
12.1 Baud Rate	28
12.2 Bits.....	29
12.3 Parity	29
12.4 Send – Sending Data to PC or Printer.....	30
12.5 Installing Drivers.....	31
12.6 Data Transmission and Exchange Protocol	32
Chapter 13: Time & Date (SET D).....	34
13.1 Time.....	34
13.2 Date.....	35
Chapter 14: Restoring Default Factory Settings (RESET).....	36
Chapter 15: Weighing (WEIGH)	37
15.1 Zeroing the Scale	37
15.2 Taring the Scale	38
15.3 Clearing the Tare	39
Chapter 16: Animal Weighing (Animal)	40
Chapter 17: Parts Counting (PARTS)	40
Chapter 18: Check Weighing (CHECK).....	40
Chapter 19: Display Hold (dHOLD)	40
Chapter 20: Percent Weighing (PERCENT).....	40
Chapter 21: Totalizing (TOTAL)	40
Chapter 22: Sealing the Calibration Switch.....	56
Chapter 32: Common Errors and Trouble Shooting.....	40
Chapter 24: Maintenance	40
Chapter 25: Accessories.....	40
Chapter 26: Replacement Parts	40
Chapter 27: Limited Warranty	40

Chapter 1: Cautionary Notes and Warnings

Important handling Cautions and Warnings

Always handle your scale with care.

Damage caused by improper handling is not covered under the scale's warranty.



Never drop or throw any articles onto the scale's pan or onto any other parts of the unit!



DO NOT let the scale fall or drop from its tabletop surface!

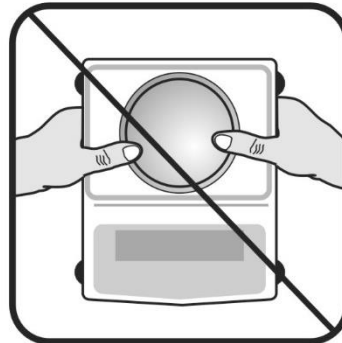

When moving the scale do not press or apply force onto the scales pan!



DO NOT pass or handle liquids directly over the scale to avoid spillage and liquid damage!

CAUTIONARY NOTES AND PRECAUTIONS

Always handle your scale with care. The correct location and proper environment makes an important contribution to the accuracy of the weighing results of TORBAL precision scales.

The optimum location for your scale:

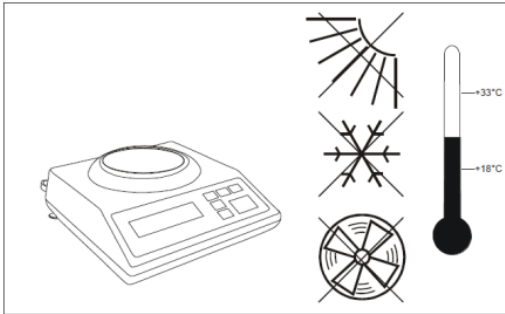

- Stable, vibration-free base as horizontal as possible
- Away from direct sunlight
- Not exposed to high temperature variations
- Away from direct drafts
- The best location is on a stable bench away from direct drafts, doors, windows, radiators and air conditioner vents.

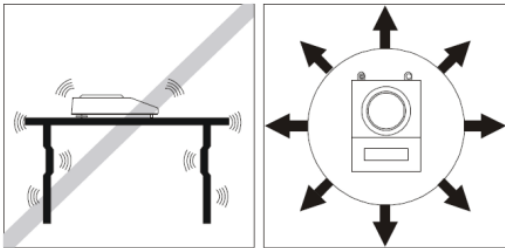

CAUTION:



- The scale is designed for indoor use only.
- Do not operate the scale in hazardous areas or under dangerous conditions.
- Do not use the scale in locations subject to high humidity or dust.
- Do not connect cables in ways other than those mentioned in this manual.
- Set the scale on a firm, stable, horizontal surface.
- Never stand on or lean on this product. Equipment may fall or collapse, causing breakage and possible injury.
- Before moving the product, unplug it and unplug all cables connected to it.
- When storing, transporting or returning the scale for service, always use the original packaging.

WARNING:



- Never attempt to repair, disassemble or modify the scale. Tampering with the scale may result in injury and cause greater damage to the equipment.
- Be sure to use the specified power source.
- Do not allow foreign matter to fall onto the scale.
- If water or other liquid spills onto the scale, unplug the power cord immediately and contact technical support.



Chapter 2: Specifications

	Model									
	AD60	AD1200	AD220	AD320	AD520	AD1200	AD2200	AD3200	AD6200	
Capacity	60g	120g	220g	320g	520g	1200g	2200g	3200g	6200g	
Readability (d)	0.001g					0.01g			0.1g	
Verification (e)	0.01g					0.1g			1g	
Repeatability (Standard Deviation)	0.001g					0.01g			0.1g	
Linearity	+/- 0.002g					+/- 0.02g			+/- 0.2g	
Tare Range	-60g	-120g	-220g	-320g	-520g	-1200g	-2200g	-3200g	-6200g	
Stabilization time (typical)	< 3s									
Calibration Masses	10, 20, 50	20, 50, 100	50, 100, 200	100, 200, 300	100, 200, 500	200, 500, 1000	500, 1000, 2000	1000, 2000, 3000	2000, 5000, 6000	
Accuracy Class	II									
Pan Dimension	4.5 in (115mm)					5.9 in (150mm)			8.9 x 6.5 in (225 x 165mm)	
Draft Shield	Optional					No				
Scale Dimension	9.4 x 10.7 x 3.6 in (239 x 273 x 91 mm)									
Operating Temperature	+15C to +30C									
RS232 Port	Bidirectional – Standard									
USB Port	Optional (Type B)									
Ethernet Port	Optional									
WiFi	Optional									
Power Supply	Input: 120VAC 60Hz 15W; Output: 12VDC 800mA									
Display Type	7 Segment LCD									
Display Size	3.75 in x 1 in (95.25 x 25.4 mm)									
Weighing Units	Grams (g), Kilogram (kg), Carat (ct), Pound (lb), Ounce (oz), Ounce Troy (ozt), Penny Weight (pwt)									
Scale Net Weight	8.8lbs							9.9lbs		
Application Modes	Weighing, Animal Weighing, Parts Counting, Check Weighing, Display Hold, Percent Weighing, Totalizing									
Printing	Yes									
Warranty	36 Months									
Parts Counting	Sample Size	1 through 100								
	Min Piece Weight	30mg				300mg			3g	
Percent Weighing	Min Reference Weight	0.1g				1g			10g	
	% Resolution Displayed (Reference Weight)	0.1% (100mg to 7g), 0.01% (7g to 70g), 0.001% (>70g)				0.1% (1g to 70g), 0.01% (70g to 700g), 0.001% (>700g)			0.1% (10g to 700g), 0.01% (>700g)	
Animal Weighing	Time Intervals	3 sec., 5 sec., 10 sec., 15 sec.								
	Modes (Min Weight)	Auto, Semi-Auto (10mg)				Auto, Semi-Auto (100mg)			Auto, Semi-Auto (1g)	
Totalizing	Modes (Min Weight)	Auto, Semi-Auto (10mg)				Auto, Semi-Auto (100mg)			Auto, Semi-Auto (1g)	
Display Hold	Modes (Min Weight)	Auto, Semi-Auto (10mg)				Auto, Semi-Auto (100mg)			Auto, Semi-Auto (1g)	

Chapter 3: Parts Description

<p>Front</p>	<p>Side</p>	<p>Rear</p>
<p>Pan</p>	<p>Pan Support</p>	<p>Draft Ring</p>
<p>AC Adapter</p>	<p>Leveling Feet</p>	<p>Bubble Level Indicator</p>
<p>AC Adapter Socket Service Switch Access RS232C Port USB Port (WiFi or Ethernet)</p>		

RS232 Cable and Printer (optional)

AC Adapter

~ 110V

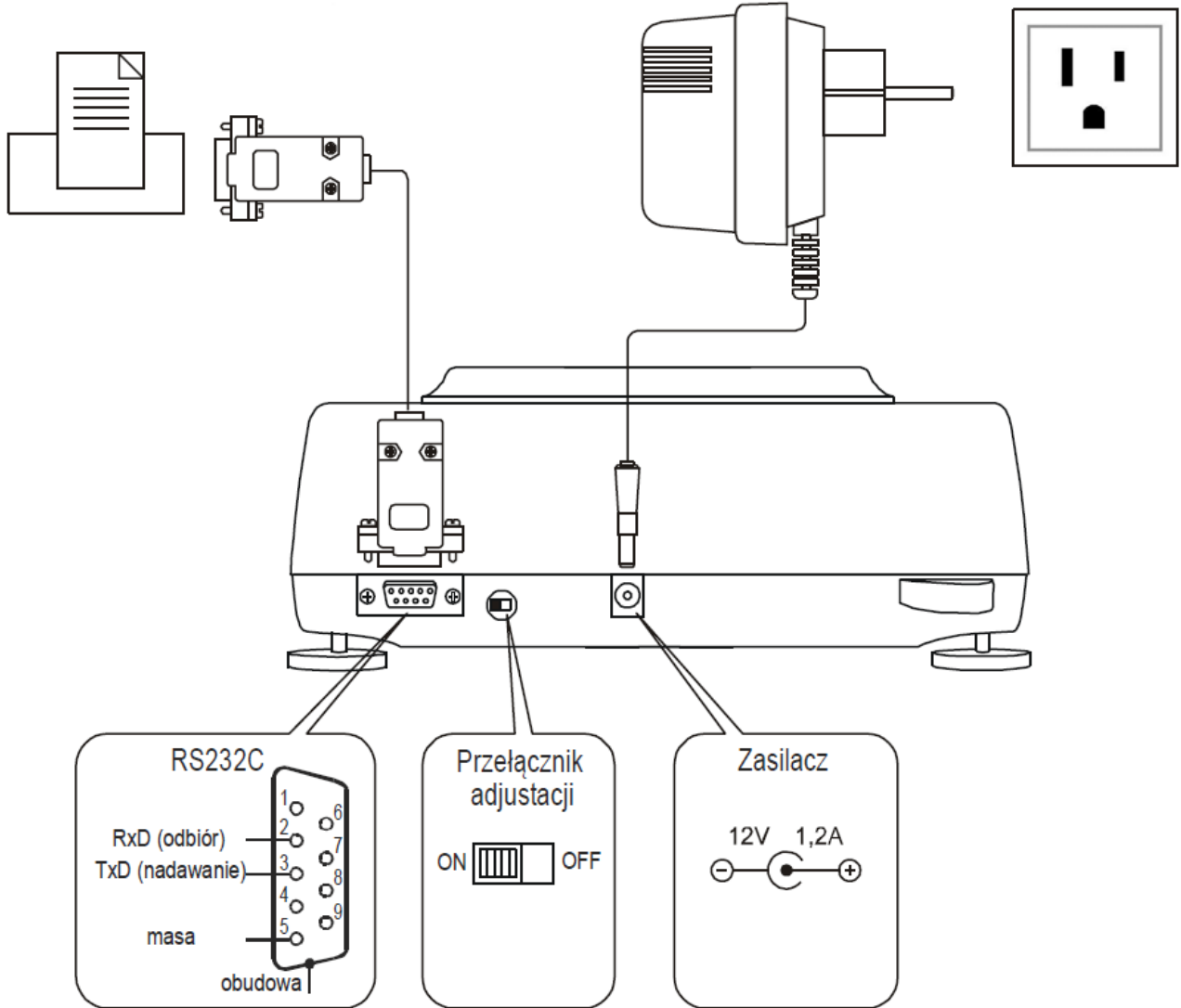



Chapter 4: Keys, Display Indicators and Commands



Key	Primary Function	Secondary Function
I/O	Power On/Off	-
←T→	Tare – used to tare the weighing pan	Enter and YES (Accept) – Used to enter or accept commands
→0←	Zero – used to zero the scale	No (Reject) – Used to reject commands or change values
M	Menu – used to access the main menu	Recall – In Totalizing this key is used to recall the Grand Total
F	Function – Used to select an application mode	Add/Start/Lock – In Totalizing (Manual) this key is used to add a result to the total. In Animal Weighing (Manual) this key is used to initiate the animal weighing process. In Display Hold (Manual) this key is used to lock the weighing result on display.
P	Data Transfer – used to print or transfer data to a PC via the communication ports	Decimal – Used to enter a decimal when assigning limit values in check-weighing
C	Clear/Cancel - Used to clear and cancel operations	Exit – Used to exit submenus
Display Indicator	Description	
OFF	Power Off	The scale is turned OFF and in standby mode.
AUT	AZSM (Auto-Zero Setting Mechanism)	AZSM is enabled and the scale maintains a “center of zero” condition within +/- 6d.
NET	Net Result	A tare was taken and the scale subtracted the tare weight from the gross weight to obtain the net weight.
→0←	Zero	The scale is maintaining a “center of zero” condition.
O	Current Setting	Indicated enabled functions or settings.
MODE	Main Menu	Indicates Main Menu Functions.
	Stability Indicator	The weighing result has stabilized and an accurate reading may be taken.



MIN	Minimum	In check weighing MIN indicates that the weighing result is below the selected under limit.
MAX	Maximum	In check weighing MAX indicates that the weighing result is above the selected over limit.
OK	Accept	In check weighing OK indicated that the weighing result is between the selected limits and the result is acceptable.
TOTAL	Total Result	In totalizing this indicator signals that the displayed result is a total sum.
PCS	Pieces	In parts count this indicator shows that the result is a piece count
%	Percent	In percent weighing this indicator shows that the result is a percentage.

Command or Abbreviation	Description
-----	Taring or re-zeroing in progress
CAL	The scale is in the calibration mode.
TARING	The scale is taring before the calibration process.
LOAD XXX g	Place a calibration weight on the pan to begin calibration.
C	Calibration in progress
CAL FIN	Calibration procedure is finished.
AW – X	In Animal Weighing, this command represents the average weighing time.
CONT	In Parts Counting, taring a container is required before continuing the counting transaction.
SAPL ON	In Parts Counting, or percent weighing this command indicates to place the sample on the pan.
SPL – XX	In Parts Counting, this command represents the current sample size setting.
FILL	In parts counting, begin counting.
UNDER	In Check Weighing, this command represents the under limit and indicates under result.
OVER	In Check Weighing, this command represents the over limit and indicates an over result.
ACCEPT	In Check Weighing, this command indicates that the weighing result is within the limit range.
TARE	In Check Weighing, tare before continuing.
SAMPLE	In Percent Weighing, this command indicates the weight of a stored reference weight.
READY	In Percent Weighing, this command indicates that the scale is ready for percent weighing based on a stored reference weight.
YES-NO	In Totalizing, this command indicates that a confirmation is required before the Totals are cleared.
PRINT	Printing in progress
COUNT FINISH, TO START COUNT PRESS C	In Parts Counting this command indicates that Parts Counting is finished.

Chapter 5: Unpacking the Scale and Getting Started

1. Carefully remove the scale, pan, and all of its components out of the packaging. Place them on a stable surface where the scale will not be affected by any mechanical vibrations or high air movements.

2. After removing the pan base and the pan from their packaging, carefully install the pan base **(2)** onto the scale by seating it on the pan support located in the middle of the scale. Once the pan base has been installed, carefully place the pan **(1)** on the base

3. Once the pan has been installed, level the scale by adjusting the front feet **(6)** until the level indicator **(7)** shows the “air bubble” is in the center position of the sight glass. The level indicator is located on the rear left side of the scale.

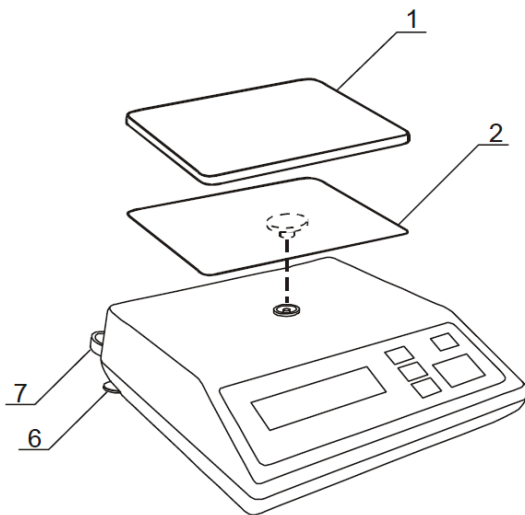
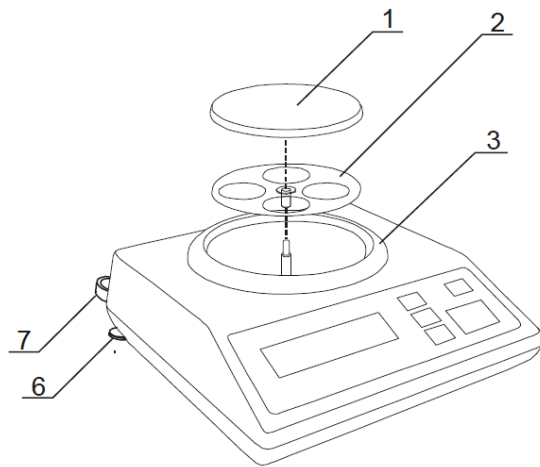

Correct



Incorrect

4. After leveling the scale, you may plug the AC adaptor to the AC adaptor socket located in the rear of the scale.

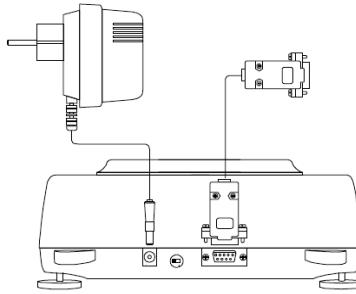

5. When the AC adaptor is plugged into the wall outlet, the scale will automatically turn on, and go through its initialization process.

6. To put the scale into standby mode, leave the AC adaptor plugged into both the scale and the wall outlet and press the Power “OFF” button. The “OFF” indicator will light up in the upper left corner of the display signaling the scale is in standby mode.

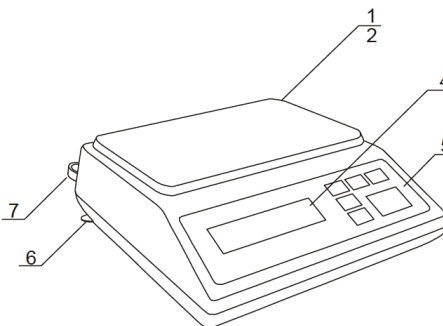
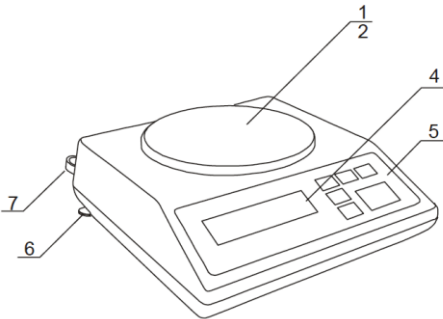
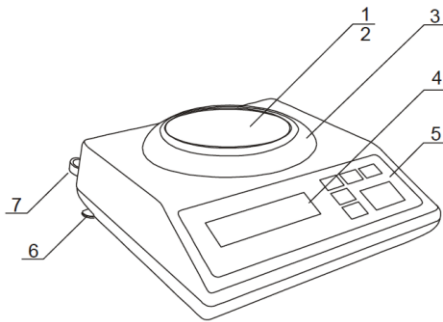
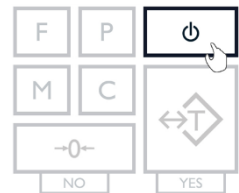

- 1 – pan
- 2 – pan support (under pan)
- 3 – draft ring
- 4 – display LCD
- 5 – keys
- 6 – rotating legs
- 7 – level indicator
- 8 – draft shield (option)
- 9 – draft shield cover (option)

Chapter 6: Main Menu

The *Main Menu* is used to configure the scale and its weighing modes. There are nine options within the Main Menu: Calibration (*CALIB*), Unit (*Unit*), Mode (*MODE*), AZSM (*AUZO*), GLP (*GLP*), Ports (*Ports*), Time/Date (*SETtd*) and Reset (*RESET*).

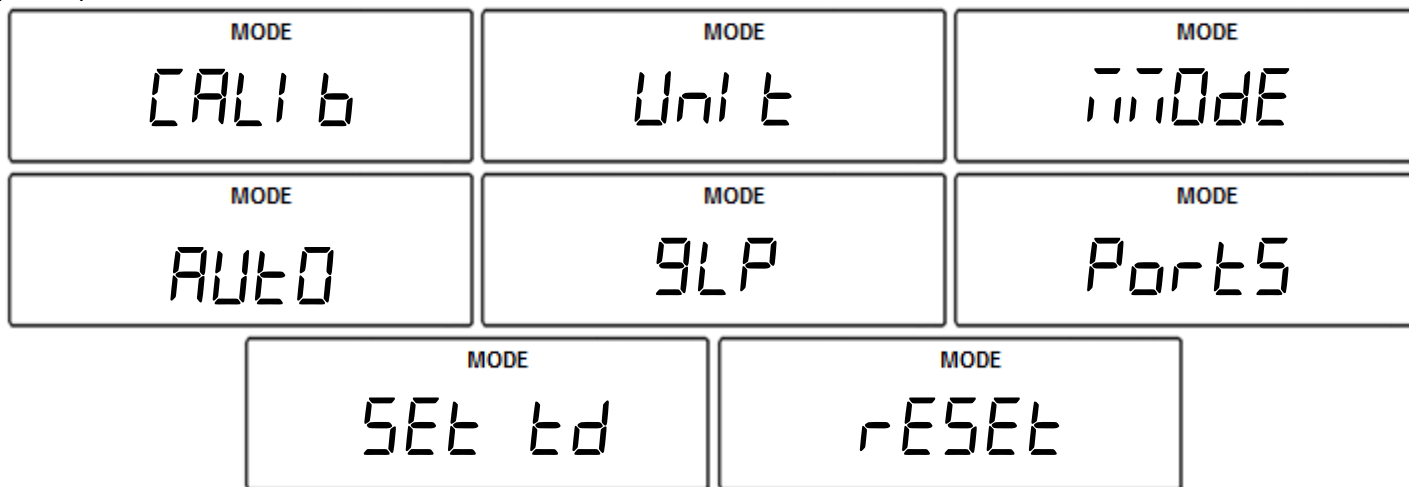

Note: Before entering the menu, complete and clear any active function by pressing the “C” key.

1. To enter the Main Menu, press the “M” key.

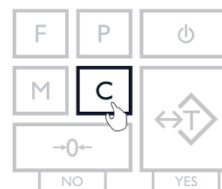
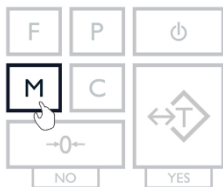

2. The scale will display available menu options sequentially. When the desired option is displayed, press the “T” (Yes) key to make the selection.

Example (Selecting Calibration):

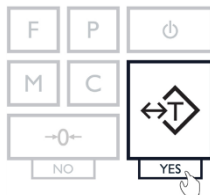
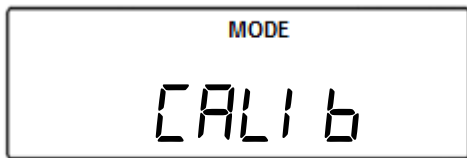

Note: Scrolling through the options may be accelerated by manually pressing the “→0←” (NO) key.

3. To exit the Main Menu, Press the “C” key.

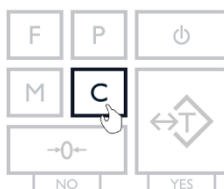

Chapter 7: Calibration (CALIBR)

7.1 Calibration – External:

External calibration can be performed with an external calibration weight equal to the scale's capacity.

Function Options:

- CAL Start (SEARt) Force automatic internal calibration to begin.
- CAL Report (rEPorT) Print Calibration Report.
- CAL Setup (SEtUP) Select calibration mass value lower than scales capacity. External Calibration not legal for trade models only.

1. To start calibration, press the "MENU" key. Select "CALIB" by pressing the "T" key.

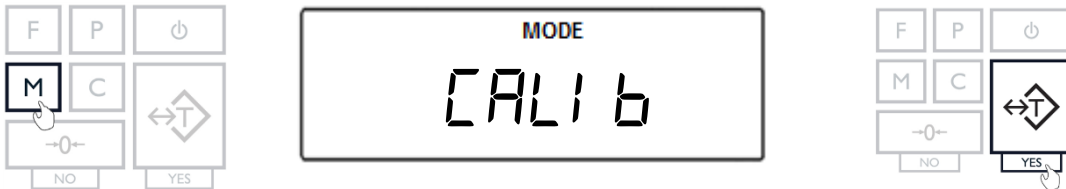

2. Select "CAL SEARt" by pressing the "T" key. The scale will then begin to perform calibration.

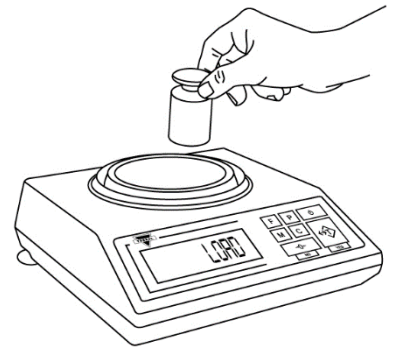
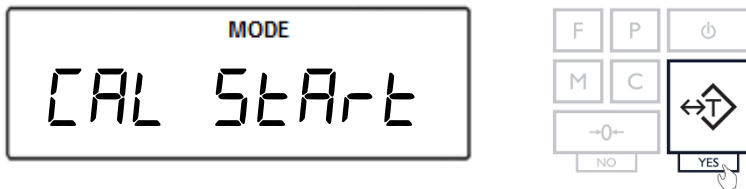

3. Wait for the scale to tare.

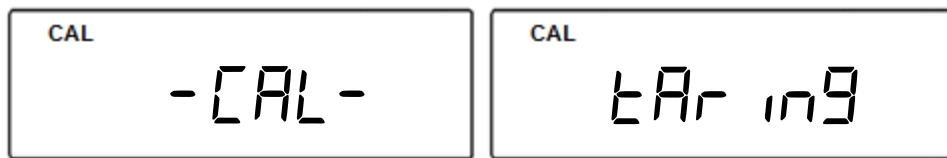

4. When prompted, load a calibration weight equal to the weight displayed on the screen. (Calibration weight varies by model).

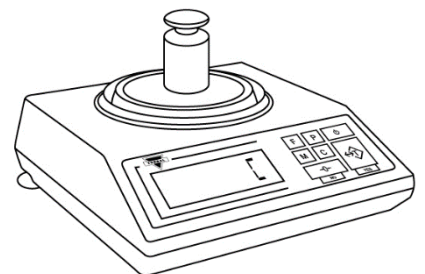
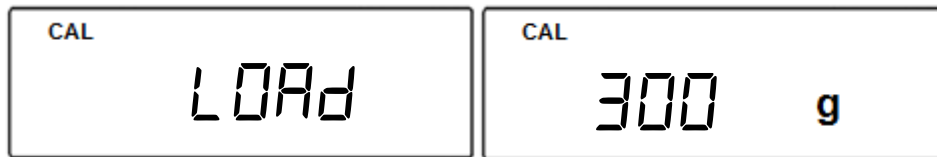

5. Wait for the scale to calibrate.



7.2 Calibration - External (NTEP Certified Legal for Trade Models Only):

External calibration can be performed with an external calibration weight equal to the scale's capacity.

6. Enter the Weighing Mode by pressing the "F" key. Select "111E1 9H" by pressing the "T" key.

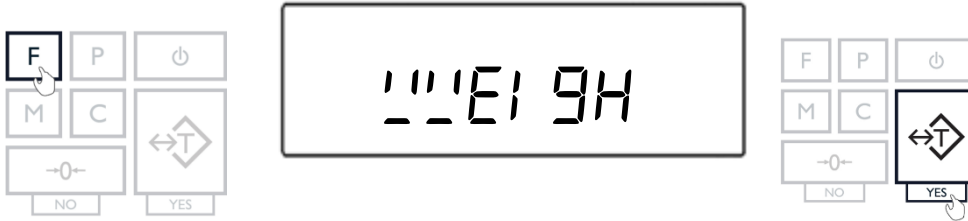

7. Use a flathead screwdriver to gently remove the Calibration Seal Screw located in the rear of the scale.

8. Once the screw has been removed and the calibration switch exposed, use a pen or another pointing device to toggle the calibration switch to the right (which is the ON position).

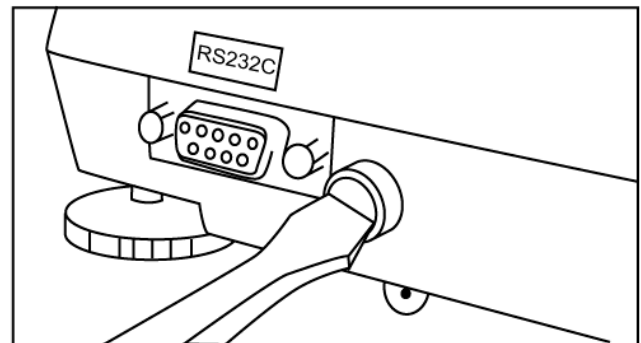

9. Upon toggling of the calibration switch, the balance will go into Calibration Mode.

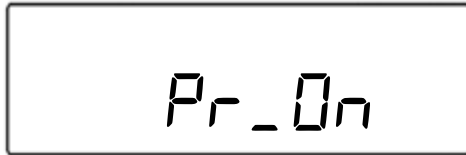

10. To start calibration, press the "M" key.

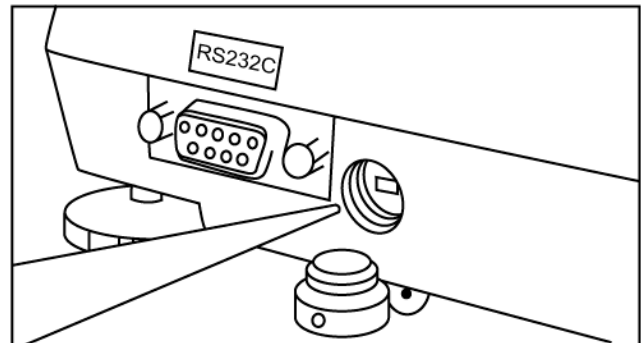
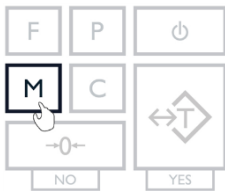

11. Select "Cal On" by pressing "T" key.

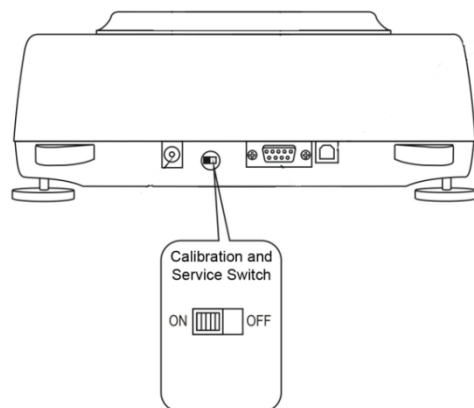
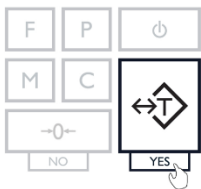

12. Wait for the scale to tare.

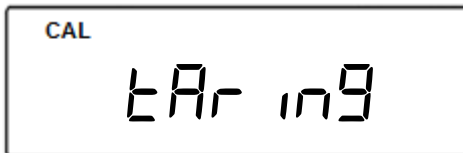

13. When prompted, load a calibration weight equal to the weight displayed on the screen. (Calibration weight varies by model).

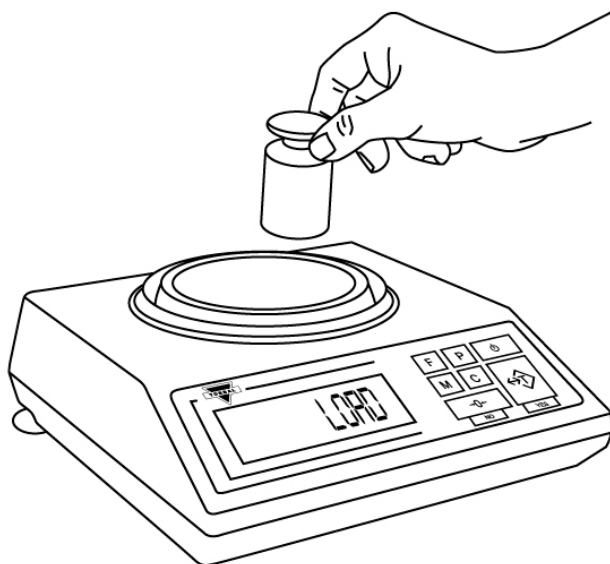

14. Wait for the scale to calibrate.

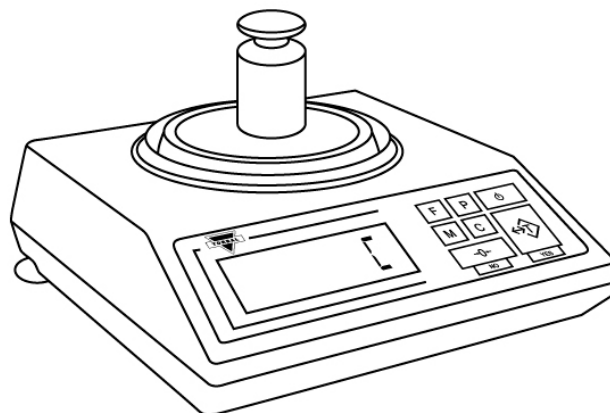
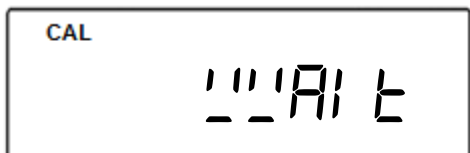

15. When calibration has ended the scale will display "Pr_0n". Toggle the calibration switch in the rear of the scale back to its original position.

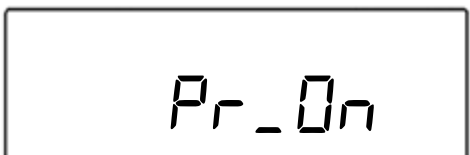

16. Insert the Calibration Seal Screw back into place.

Chapter 8: Units of Measure Selection (Unit) Not Legal for Trade models only

TORBAL AD series scales can operate in nine different units of measure: grams (g), kilograms (kg), carats (ct), pounds (lb), Newton (N), grains (gn), ounces (oz), ounces troy (oz-t), and pennyweights (dwt).



By factory default the scale is set to weigh in grams (g). To select a different unit, follow the steps below.

1. Press the “M” key. Select “Unit” by pressing the “T” key.

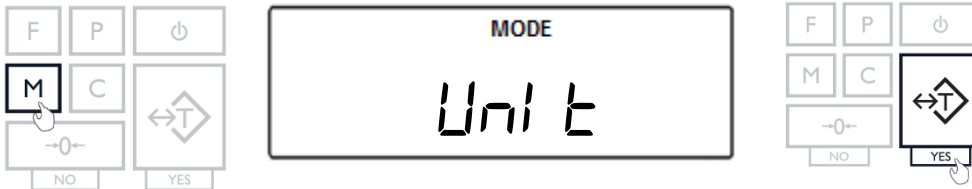

2. The scale will display available units of measure sequentially. When the desired unit is displayed, press the “T” (Yes) key to make the selection.

Example (Selecting Kilograms):

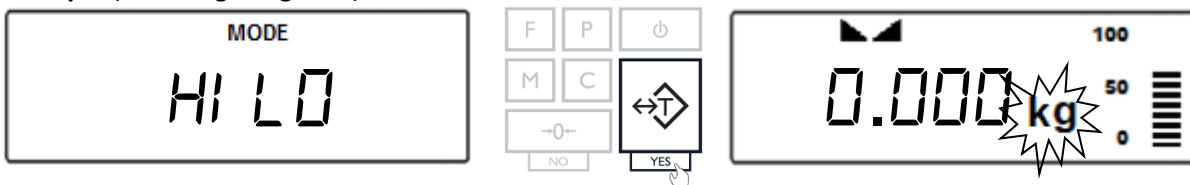

Example (Selecting Ounces):

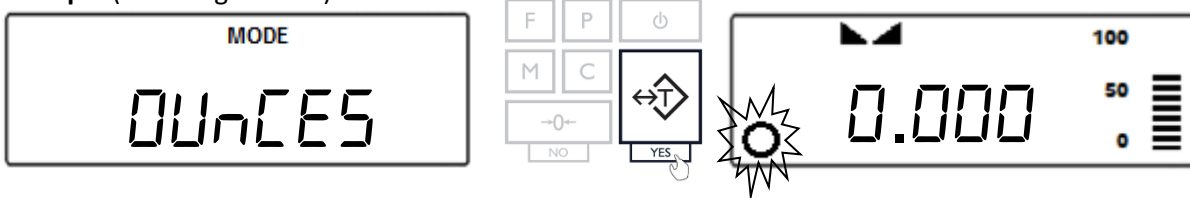

Note: When grams (g), kilograms (kg), carats (ct), pounds (lb), or Newton (N) are selected, the symbol for that unit will appear to the right of the display. When a unit of measure other than the aforementioned is selected, an indicator will appear in the bottom-left corner of the display.

3. To exit the Main Menu, use the “C” key.

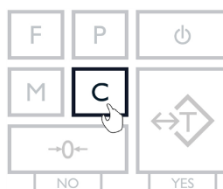

Chapter 9: Mode Configuration (MODE)

TORBAL AD series scales can operate in six application modes: Animal Weighing (ANIMAL), Parts Counting (PARTS), Check Weighing (CHECK), Display Hold (DISPLAY), Percent Weighing (PERCENT), and Totalizing (TOTAL).

Before an application mode can be used, it must be enabled and configured. Once the application mode is enabled it will be available for selection from the Function Menu.

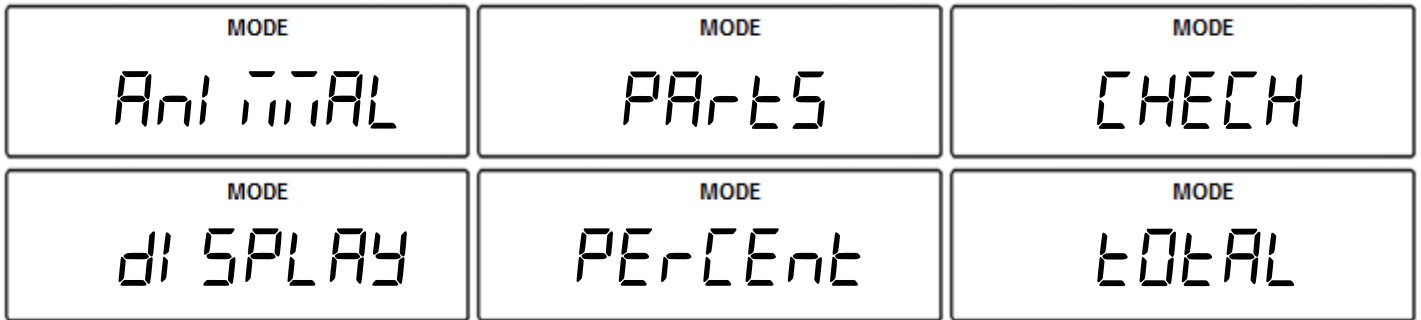

By factory default the scale is in the weighing mode (WEIGHT). To enable other application modes, follow the steps below.

1. Press the “M” key. Select “MODE” by pressing the T key.

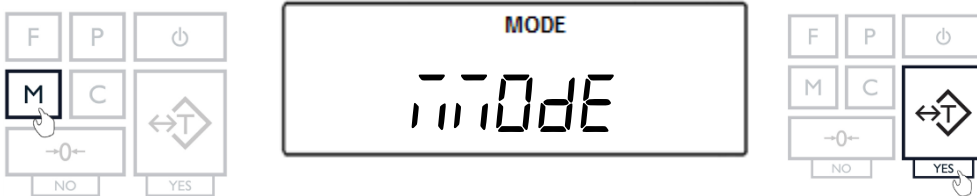

2. The scale will display available modes sequentially. When the desired mode is displayed, press the “T” key (Yes) to make the selection.

Example (Selecting Animal Weighing):

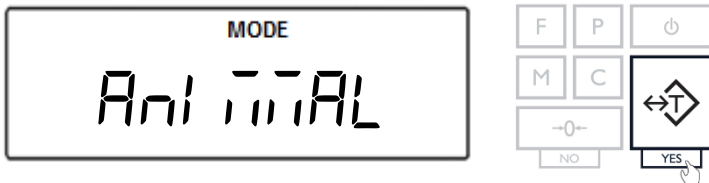

Note: Scrolling through the options may be accelerated by pressing the “→0←” (NO) key.

- Check individual Mode sub-chapters for more information on each.

9.1 Animal Weighing Configuration

Animal weighing is used to weigh live animals and other dynamic loads. A choice of 3 different operating modes and 4 different weight integration periods ensures the user the best results in the least amount of time per measurement.

1. To enable Animal Weighing, select “Ani Weigh” in the Mode Menu by pressing “T” (YES) key.

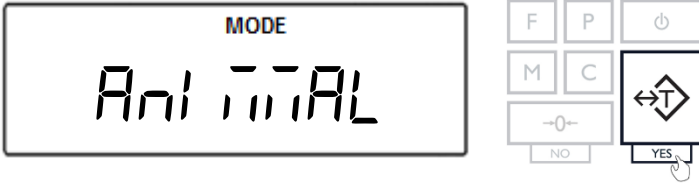

2. Commands “An On” and “An Off” will be displayed sequentially. To enable Animal Weighing, select “An On” with the “T” key. To disable Animal Weighing, select “An Off” with the “T” key.



3. Animal weighing can operate in three different modes: Automatic (Auto), Semi-automatic (SE-Auto) and Manual (Manual) (see Table 9.1). The three operating modes will display sequentially. When the desired mode is displayed, press the “T” key to make the selection.

Example (Selecting Automatic):

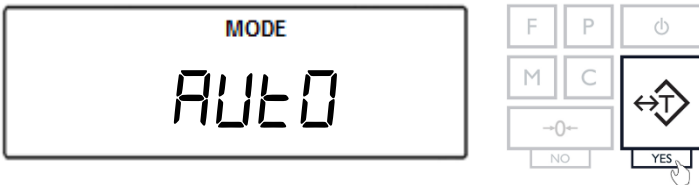

4. Once the desired operating mode for animal weighing has been selected, the scale will display time intervals for the animal weighing process, sequentially. The intervals are: 3 seconds (t- 3), 5 seconds (t- 5), 10 seconds (t- 10), and 15 seconds (t- 15). Select a time interval by pressing the “T” (Yes) key.

Example (Selecting 10 seconds):

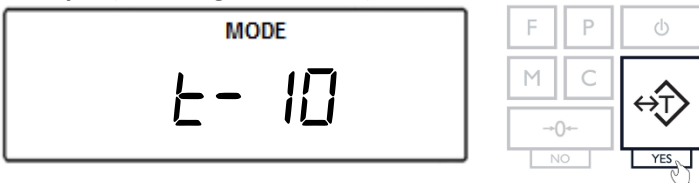

Note: Select longer time intervals when weighing very active animals. Longer time intervals will allow the scale to take more readings while the animal is moving on the pan and provide an accurate result.

- After selecting the time interval, “dOnE” will be displayed, indicating that the function has been configured and it is ready to use.

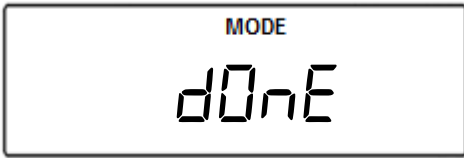

To use the function, follow the directions given in Chapter 16. To exit the mode menu press the “C” key.

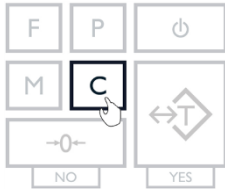

Mode	Configuration	Description
Automatic	Weighing Initialization: Automatic Result Clearing: Automatic Tare: Automatic	When set to Automatic, the scale will automatically begin the animal weighing process. Once the animal is removed from the weighing pan, the scale will automatically tare and prepare for the next weighing.
Semi-Automatic	Weighing Initialization: Automatic Result Clearing: Manual Tare: Manual	When set to Semi-Automatic, the scale will automatically begin the animal weighing process. Once the animal is removed from the weighing and the result remains displayed until it is manually cleared. The scale must be manually tared before the next weighing.
Manual	Weighing Initialization: Manual Result Clearing: Manual Tare: Manual	When set to Manual, the animal weighing process must be manually initialized. Once the animal has been weighed and the pan cleared the result must be manually cleared. The scale must be manually tared before the next weighing.

9.2 Parts Counting Configuration

Parts Counting is used to count a batch of items based on their weight. A sample is taken to determine the average piece weight of the items.

1. To enable Parts Counting, select “PARTS” in the Mode Menu by pressing “T” (YES) key.

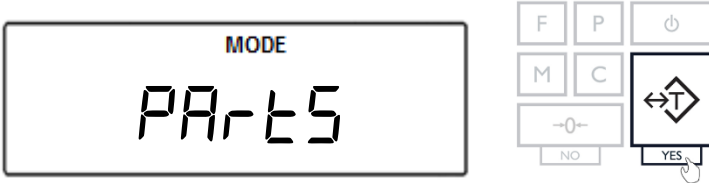

2. Commands “Co On” and “Co OFF” will be displayed sequentially. To enable Parts Counting, select “Co On” with the “T” key. To disable Parts Counting, select “Co OFF” with the “T” key.



3. A sample size must be configured for establishing the average piece weight. The default sample size of 10 pieces will be displayed (SPL- 10). To accept the sample size press the “T” (YES) key. To change the sample size press the “→0←” (NO) key.



The sample size selection ranges from 1 to 100. Quickly press and release the “→0←” (NO) key to change the sample size by increments of one. Press and hold the “→0←” (NO) key to change the sample size in increments of five. Once a desired sample size is displayed, press the “T” (YES) key to accept and confirm the selection.

Example (Selecting SPL-99):

Press and hold the “→0←” key until the display reads 95. Apply four single presses until the sample size reads 99. Press the T key to confirm the selection.



Note: Larger sample size results in a more accurate average piece weight. Select a sample size greater than 10 pieces if a large weight variance might exist between the counted pieces.

- After selecting the sample size, “dOnE” will be displayed, indicating that the function has been configured and it is ready to use.

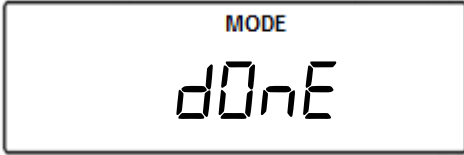

- To use the function follow the directions in Chapter 17. To exit the mode menu use the “C” key.

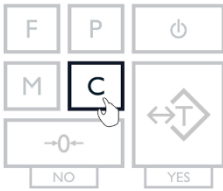

9.3 Check Weighing Configuration

The Check Weighing function is used to compare the weight of an object against a preset target range. Depending on the set tolerances, the scale will display “Over,” “Under,” or “ACCEPT.”

- To enable Check Weighing, select “CHECH” in the Mode Menu by pressing “T” (YES) key.

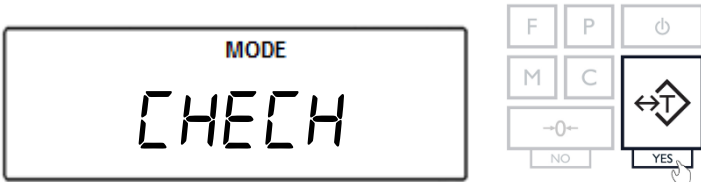

- Commands “CHH On” and “CHH OFF” will be displayed sequentially. To enable Check Weighing, select “CHH On” with the “T” key. To disable Check Weighing, select “CHH OFF” with the “T” key.



- After enabling Check Weighing, “dOnE” will be displayed, indicating that the function has been configured and it is ready to use.

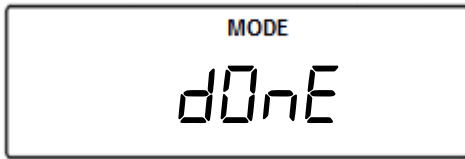

4. To use the function follow the directions in Chapter 18. To exit the mode menu use the “C” key.

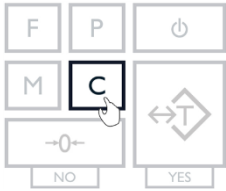

9.4 Display Hold Configuration

Display Hold is used to lock a weight reading on the screen, even after the weighed object has been removed from the pan.

1. To enable Display Hold, select “dI SPLAY” in the Mode Menu by pressing “T” (YES) key.

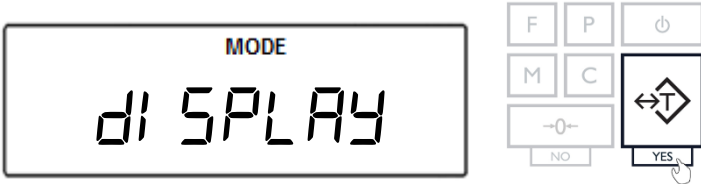

2. Commands “dI On” and “dI OFF” will be displayed sequentially. To enable Display Hold, select “dI On” with the “T” key. To disable Display Hold, select “dI OFF” with the “T” key.

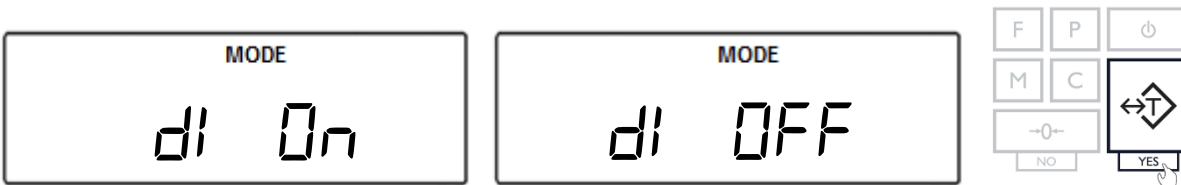

3. Display Hold can operate in three different modes: Automatic (AUtO), Semi-automatic (SE-AUtO) and Manual (MAnUAL) (see Table 9.4). The three operating modes will display sequentially. When the desired mode is displayed, press the “T” key to make the selection.

Example (Selecting Automatic):

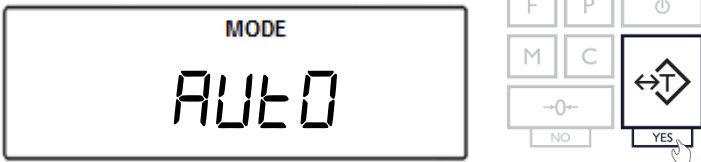

4. After selecting the operating mode, “dOnE” will be displayed, indicating that the function has been configured and it is ready to use.



5. To use the function follow the directions in Chapter 19. To exit the mode menu use the “C” key.

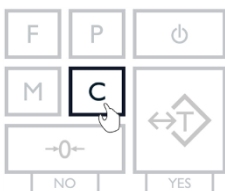

Automatic	Display Hold Initialization: Automatic Result Clearing: Automatic Tare: Automatic	When set to Automatic, the scale will automatically lock and hold the first stable weight reading on the display. When the weight is removed the scale will automatically clear the result. Once the result is cleared the scale will automatically tare and prepare for the next weighing.
Semi-Automatic	Display Hold Initialization: Automatic Result Clearing: Manual Tare: Manual	When Set to Semi-Automatic, the scale will automatically lock and hold the first stable weight reading on the display. When the weight is removed it must be manually cleared. Before starting the next weighing the scale must be manually tared.
Manual	Weighing Initialization: Manual Result Clearing: Manual Tare: Manual	When set to manual, the first stable weight reading on the display must be locked manually. When the weight is removed it must be manually cleared. Before starting the next weighing the scale must be manually tared.

9.5 Percent Weighing Configuration

Percent Weighing is used to compare the relative weight of an unknown item to that of a previously stored sample.

1. To enable Percent Weighing, select “PERCENT” in the Mode Menu by pressing “T” (YES) key.

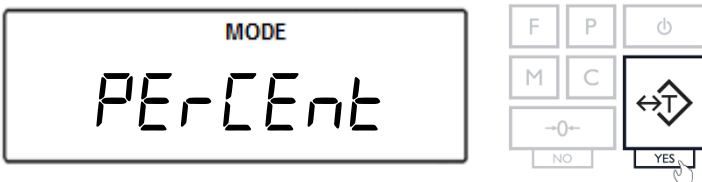

2. Commands “PE On” and “PE OFF” will be displayed sequentially. To enable Percent Weighing, select “PE On” with the “T” key. To disable Percent Weighing, select “PE OFF” with the “T” key.

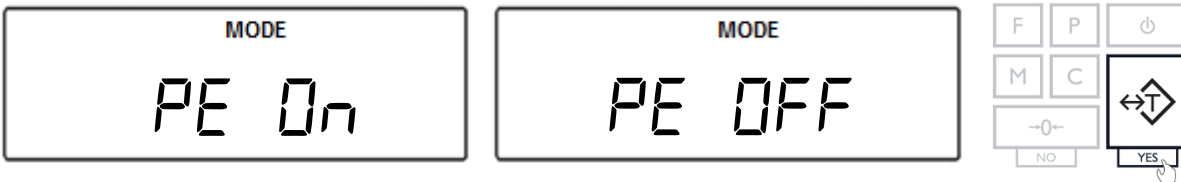

3. After enabling Percent Weighing, “dOnE” will be displayed, indicating that the function has been configured and it is ready to use.

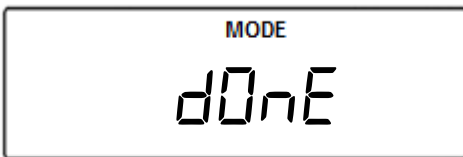

4. To use the function follow the directions in Chapter 20. To exit the mode menu use the “C” key.

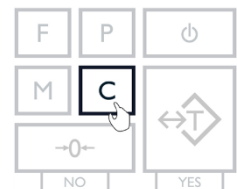

9.6 Totalizing Configuration

Totalizing is used to calculate the summation of multiple weights that are recorded sequentially.

1. To enable Totalizing, select “TOTAL” in the Mode Menu by pressing “T” (YES) key.

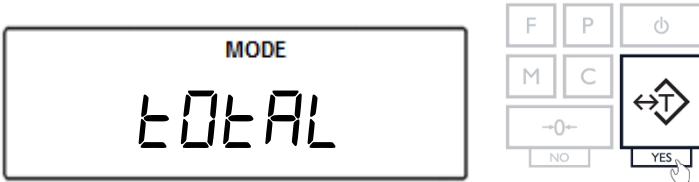

2. Commands “TOTAL On” and “TOTAL OFF” will be displayed sequentially. To enable Totalizing, select “TOTAL On” with the “T” key. To disable Totalizing, select “TOTAL OFF” with the “T” key.

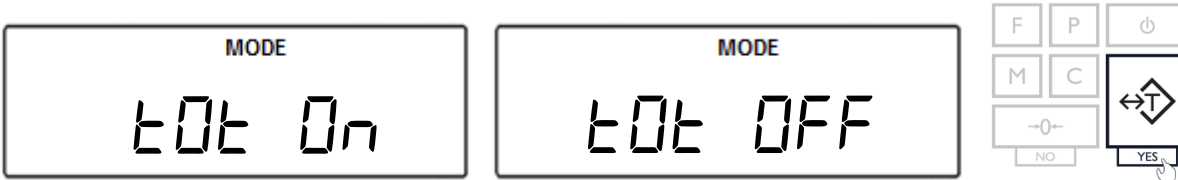

3. Totalizing can operate in three different modes: Automatic (AUTO), Semi-automatic (SE-AUTO) and Manual (MANUAL) (see Table 9.6). The three operating modes will display sequentially. When the desired mode is displayed, press the “T” key to make the selection.

Example (Selecting Automatic):

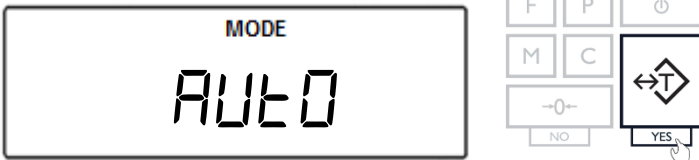

4. After selecting the operating mode, “done” will be displayed, indicating that the function has been configured and it is ready to use.

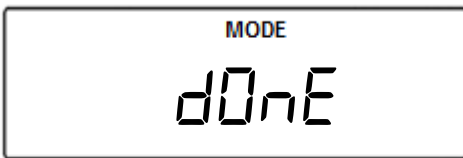

5. To use the function follow the directions in Chapter 21. To exit the mode menu use the “C” key.

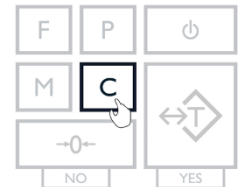

Table 9.6: Totalizing Operating Modes

Automatic	Totalizing and Adding: Automatic	When set to Automatic, the scale will automatically add the first stable weight reading to the total.
Manual	Totalizing and Adding: Manual	When set to Manual each weigh has to be manually added to the total by pressing a designated key.

Chapter 10: Auto Zero Setting Mechanism – AZSM (AUTO)

All AD scales are equipped with AZSM, the “Auto Zero Setting Mechanism.” AZSM automatically maintains a “center of zero” condition within +/- 6d (i.e. 6 mg on scales with 0.001g readability).

To enable or disable AZSM follow the steps below.

1. Press the “M” key. Select “AUTO” by pressing the “T” key.

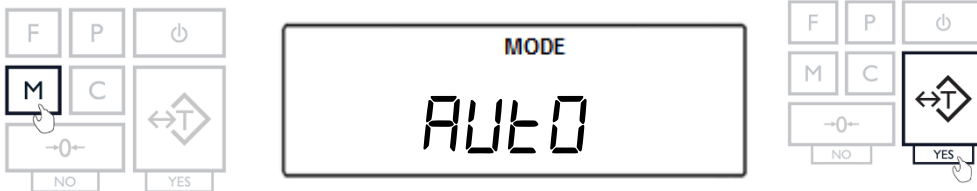

2. To enable AZSM press the “T” key when “AUTO On” is displayed. To disable AZSM press the “T” key when “AUTO OFF” is displayed.



3. Once enabled, the “AUT” indicator will be displayed.

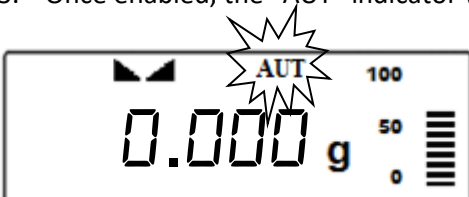



Chapter 11: GLP Print and Data Configuration (GLP)

When enabled, GLP data will appear on every printed transaction receipt. The GLP printout includes Unit ID (*Unit Id*), User ID (*USER Id*), Project No. (*PROJECT*), Notes / Remarks field, and a Signature field.

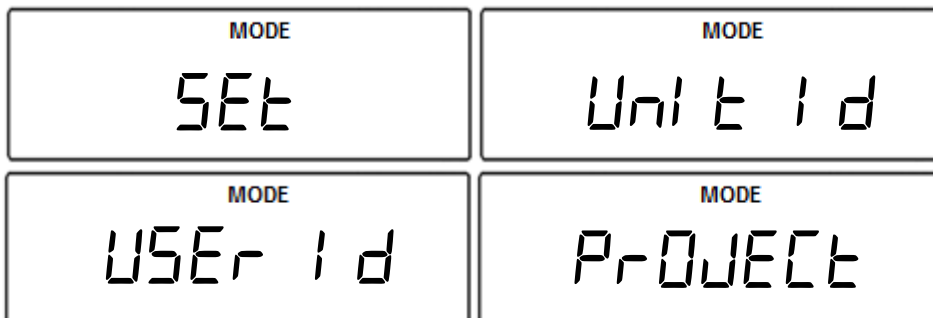

Example of printout:

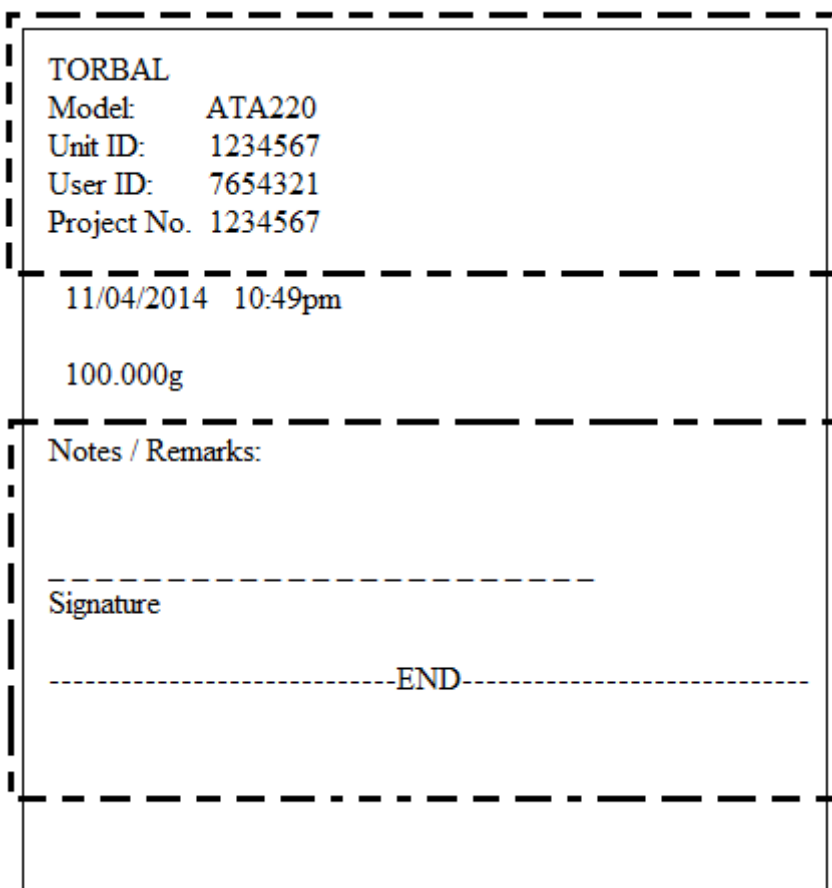

To enable and configure GLP data printing, follow the steps below.

1. Press the “M” key. Select “GLP” by pressing the “T” (YES) key.

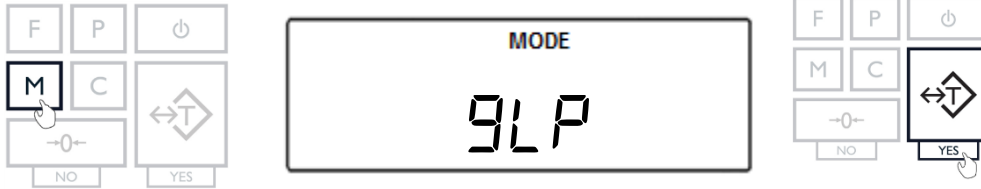

2. Select “SET” by pressing the “T” (YES) key.

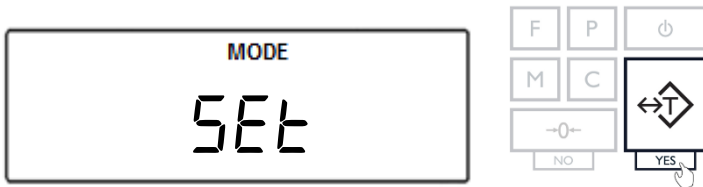

3. To enable GLP, press the “T” key when “On” is displayed. To disable GLP, press the “T” key when “OFF” is displayed.



4. Once enabled, configurable options including Unit ID (Unit Id), User ID (User Id), Project No. (Project) will display. Select an option by pressing the “T” key.

Example (Selecting Model):

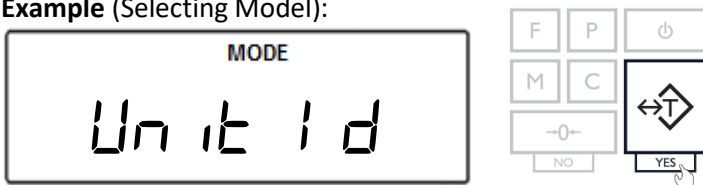

5. A dash will be displayed, indicating you may assign a value.

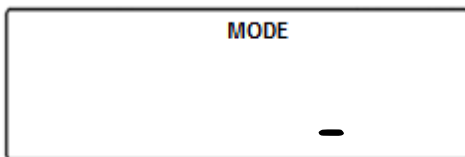

Note: ID numbers can consist of up to six digits.

6. Press the “→0←” key (NO) to increment a digit. Press the “T” (YES) to accept and add a digit.

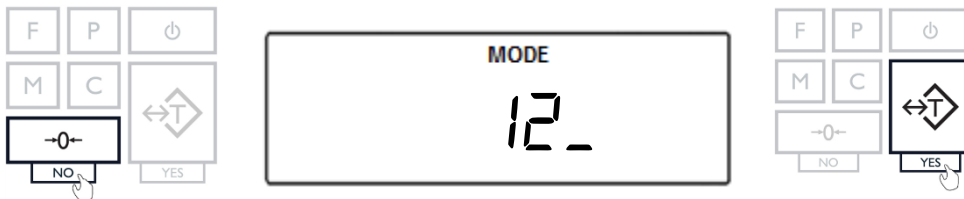

7. Press the “F” key to accept the entire setting. Press the “C” key to clear and start over.

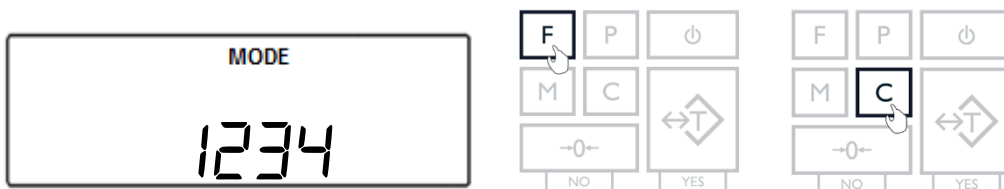

To become familiar with entering a value, refer to the example in **Table 11.1**.

Current display	Action to take	Key to use	Number of depressions	Display becomes
-	Increment the digit	→0← (No)	6	5
5	Accept and go to next digit	T (Yes)	1	50
50	Increment the digit	→0← (No)	4	54
54	Accept and go to next digit	T (Yes)	1	540
540	Increment the digit	→0← (No)	3	543
543	Accept and go to next digit	T (Yes)	1	5430
5430	Increment the digit	→0← (No)	2	5432
5432	Accept the entire setting	T (Yes)	1	54320
54320	Increment the digit	→0← (No)	1	54321
54321	Accept the entire setting	FUNCTION	1	--

Chapter 12: Printing Data and Communication Ports (Ports)

After a weighing or counting transaction is completed, a result data receipt can be printed. To initiate printing, press the “P” key. Data may be sent to a printer or a PC via the Torbal Communication Software.

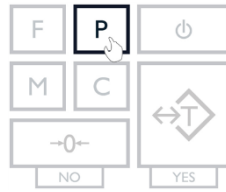

USB and RS232 Ports

The scale is equipped with both USB and RS232 interface ports. These interfaces are both configurable through the Ports menu. The USB and RS232 can be configured by their baud rate, number of bits, and parity type.

1. To configure the ports, press the “M” key. Select “Ports” by pressing the “T” key.

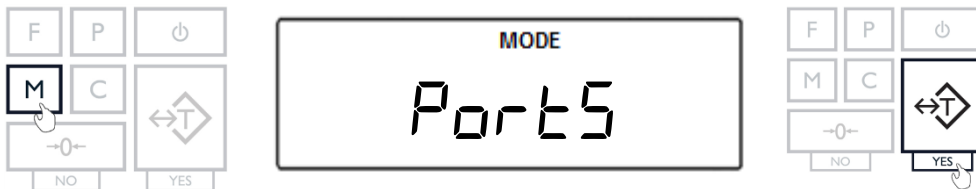

2. Choose the ports to be configured by selecting “RS232” or “USB”. Confirm the selection by pressing the “T” key.



12.1 Baud Rate

1. To configure the Baud Rate select “bAUD” by pressing the “T” key.

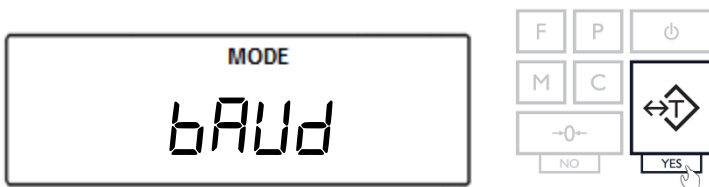

- Choose the baud rate to be used (“1200”, “2400”, “4800”, “9600”, “19200”, “38400”, “57600”, and “115200”). To confirm the selection, press the “T” key.

Example (Selecting 9600):



12.2 Bits

- To configure the number of bits select “b1 t5” by pressing the “T” key.

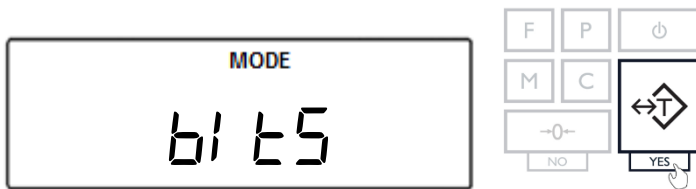

- Choose “7 b1 t5” or “8 b1 t5”. To confirm the selection, press the “T” key.

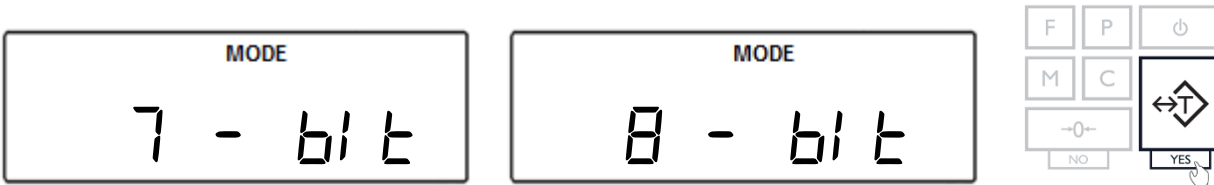

12.3 Parity

- To configure the parity type select “PARi ty” by pressing the “T” key.

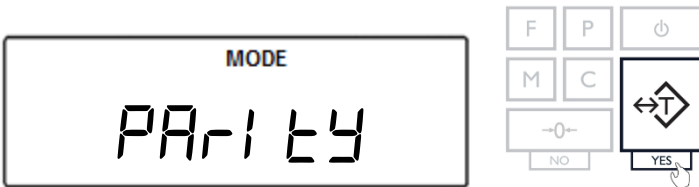

- Choose the parity type to be used (“nonE”, “odd”, and “EVEN”). To confirm the selection, press the “T” key.

Example (Selecting None):

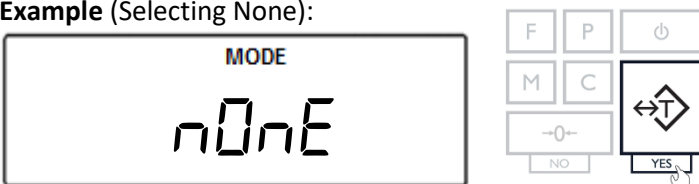

12.4 Send – Sending Data to PC or Printer

- To configure the data sending format type select “SEnF” by pressing the “T” key.



- Choose the data sanding format (“oFF”, “StAb”, “noStAb”, “AUtO”, “rEiDUE” and “EuEn”). To confirm the selection, press the “T” key.

Stab (StAb)	Stable Required	Stable weighing result is required before data is sent
NoStab (noStAb)	No Stability Required	Result is sent as soon as the transfer data button is pressed. Scale does not wait for a stable result
Auto (AUtO)	Automatic	Weighing result is automatically transferred from the scale after it stabilizes (no push key required)
Cont (Cont)	Continuously	Weighing results is continuously transferred from the scale at all times. (no push key and no stability required)
Remove (rEiDUE)	Remove All Characters	All none mass result characters are removed. Scale send only numeric mass values. Date, Time, Unit of measure are removed
Clean (CLEAn)	Exclude All Characters	All none mass result characters are excluded from data transfer. Scale sends only numeric mass values. Date, Time, Unit of measure are removed

Example (Selecting None):

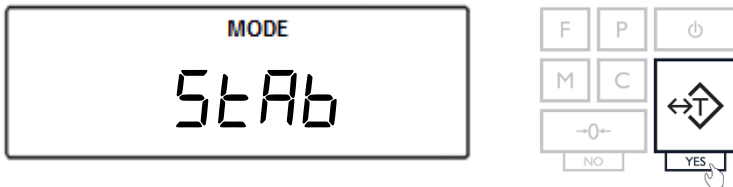

12.5 Installing Drivers

Before connecting the scale to a computer the USB Port must be configured with the appropriate baud rate and other necessary parameters. To configure the USB Port, follow configuration steps from this chapter and apply them to the USB settings.

PC Connection via USB

Once the USB port has been configured, connect the scale to the PC with a Standard A/B USB cable and follow the “Found New Hardware” configuration wizard as described below.

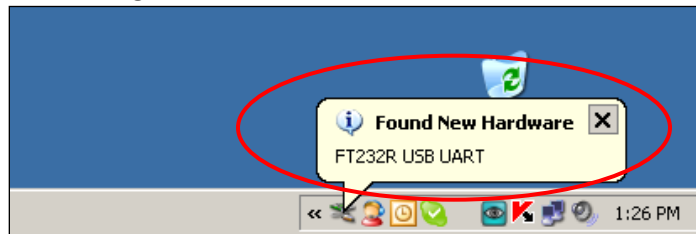

1. Allow Windows to connect to Windows Update in order to search for software. Select “Yes, this time only” and click “Next”. Once driver “FT232R USB UART” has been found, select “Install the software automatically (Recommended)” and click “Next”.

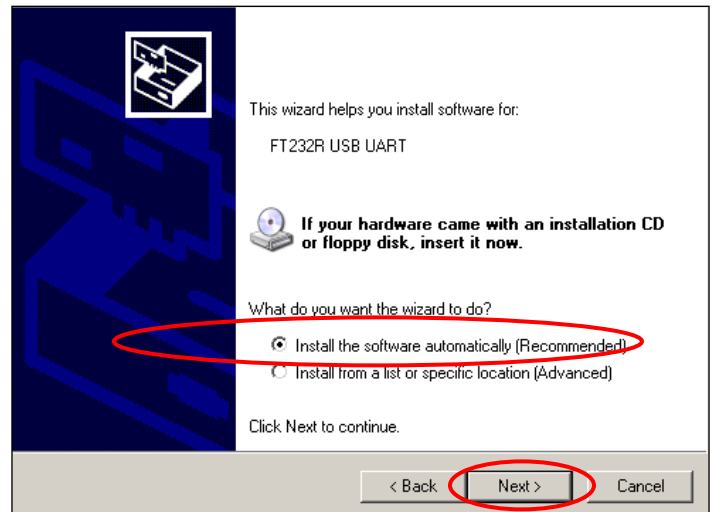
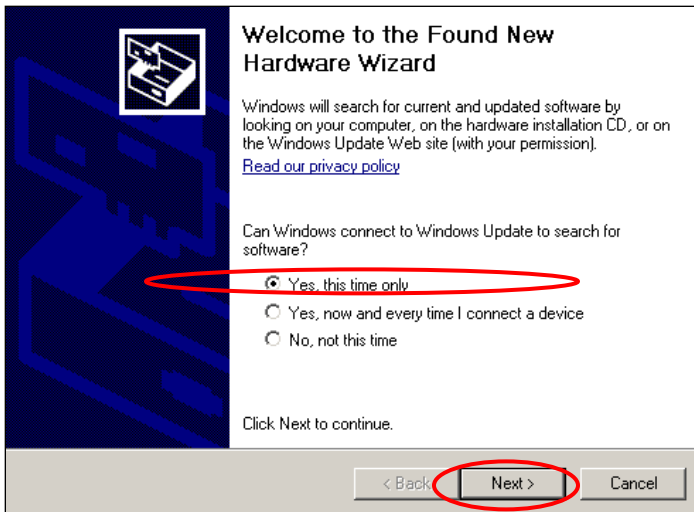

2. Windows will begin installation of the driver, when completed click “Finish”.

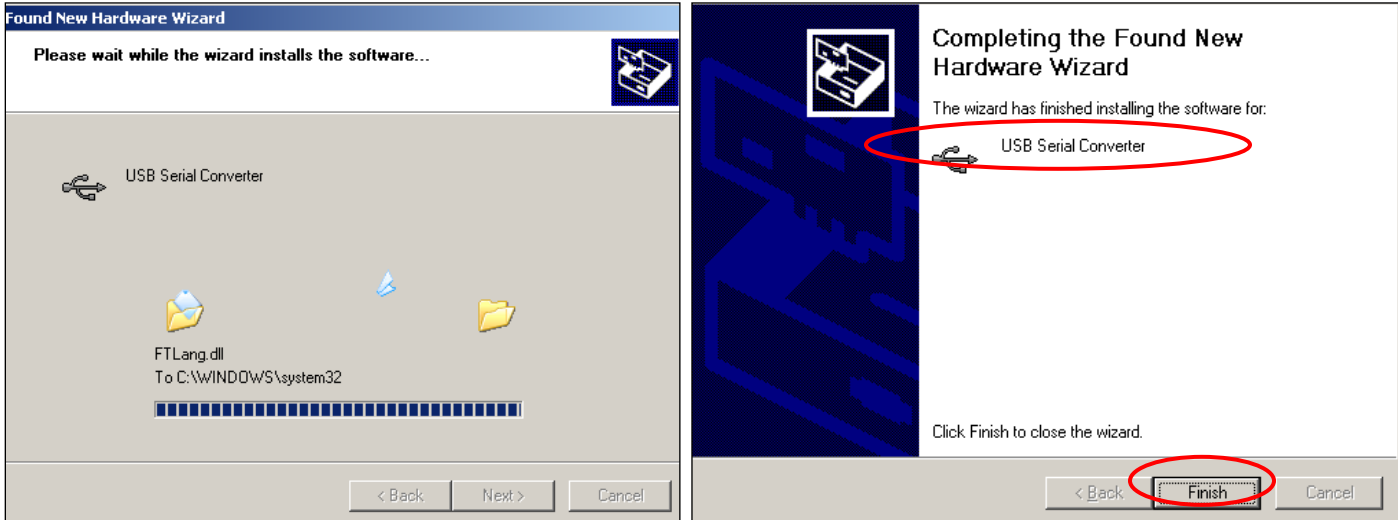

3. Once installation of the driver has been completed the scale is ready to communicate with the PC via the USB port.

12.6 Data Transmission and Exchange Protocol

Data Transmission (LONG):

Transmission Parameters: 8 bits, 1 stop bit, no parity, baud rate 4800bps,

Exchange data:

- Transmit the weight (equivalent to the Print Key, , in weighing:
 Computer→Scale: **S I** CR LF (53h 49h 0Dh 0Ah) – initiating signal,
 Scale→Computer: scale sends 16 Bytes of data as follows:

- Byte 1 - The character '-' or space
- Byte 2 - space
- Bytes 3,4 - digit or space
- Bytes 5-9 - digit, comma, or space
- Byte 10 - digit
- Byte 11 - space
- Byte 12 - k, l, c, p or space (for kg,lb,ct,pc, or%)
- Byte 13 - g, b, t, c or %
- Byte 14 - space
- Byte 15 - CR
- Byte 16 - LF

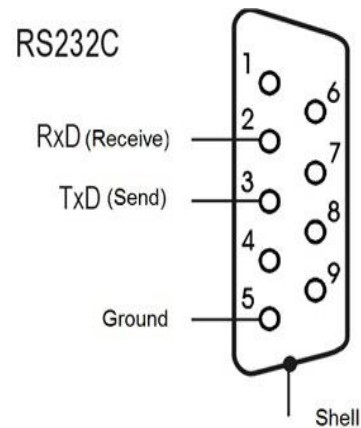

- ‘Tare the weight’ (corresponds to the →T← key in weighing):
 Computer→Scale: **S T** CR LF (53h 54h 0Dh 0Ah),
 Scale→Computer: no response.
- ‘Zero the scale’ (corresponds to the key →0← in weighing):
 Computer→Scale: **S Z** CR LF (53h 5Ah 0Dh 0Ah),
 Scale→Computer: no response.
- ‘Turn On / Off the Scale (corresponds to the key I/⏻ in weighing):
 Computer→Scale: **S S** CR LF (53h 53h 0Dh 0Ah),
 Scale→Computer: no response.
- ‘Display the MENU’ (corresponds to the key MENU in weighing):
 Computer→Scale: **S F** CR LF (53h 46h 0Dh 0Ah),
 Scale→Computer: no response.
- Setting the threshold 1 (optional):
 Computer→Scale: **S L D1...DN** CR LF (53h 4Ch D1...DN 0Dh 0Ah)
 where: D1...DN – Threshold value, up to 8 characters,
 Scale→Computer: no response,
- Example:
 To set 1000g in weight B1.5 (d=0.5g) type:
 S L 1 0 0 0 . 0 CR LF (53h 4Ch 31h 30h 30h 30h 2Eh 30h 0Dh 0Ah).
 To set 100kg in weight B150 (d=50g) type:
 S L 1 0 0 . 0 0 CR LF (53h 4Ch 31h 30h 30h 2Eh 30h 30h 0Dh 0Ah),
- Setting the threshold 2 (optional):
 Computer→Scale: **S H D1...DN** CR LF (53h 48h D1...DN 0Dh 0Ah),
 where: D1...DN – threshold value, up to 8 characters,
 Scale→Computer: no response

Cable WK-1 Configuration

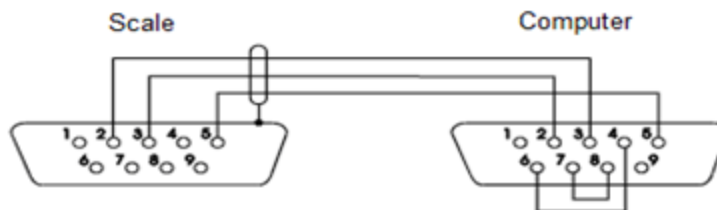

Cable WD-1 Configuration

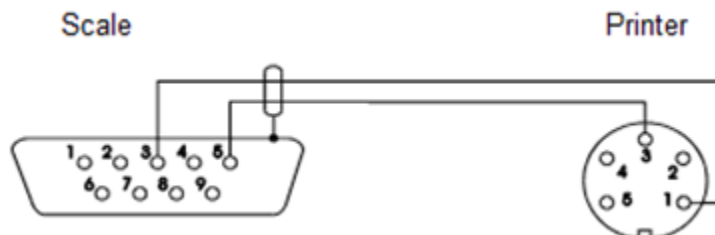

Chapter 13: Time & Date (SEt tD)

To set the current time and date, follow the steps below.

13.1 Time

1. Press the “M” key. Select “SEt tD” by pressing the “T” key.

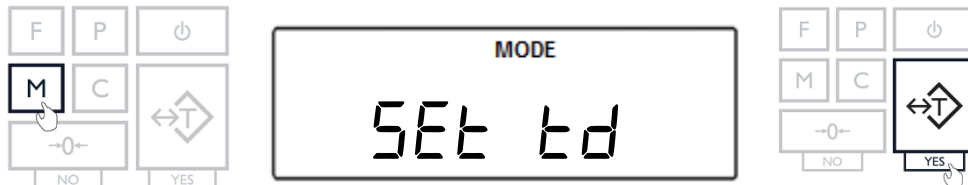

2. Select “tI mE” by pressing the T key.

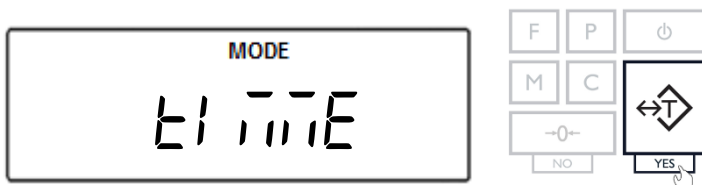

3. The current time setting will be displayed. To adjust the time press the “→0←” (NO) key.

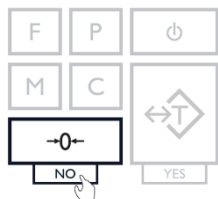

4. Use the →0← key to select “A” AM or “P” PM. Confirm selection with T key.

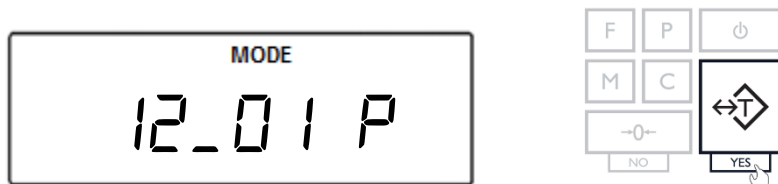

5. Use the →0← key to change minutes and hours. Press the T key to advance and confirm the time setting.

13.2 Date

1. Press the “M” key. Select “SEt tD” by pressing the “T” key.

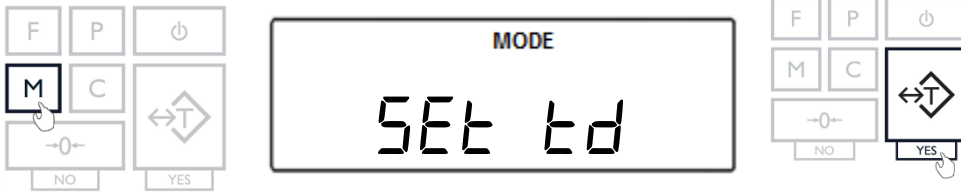

2. Select “dAtE” by pressing the T key.

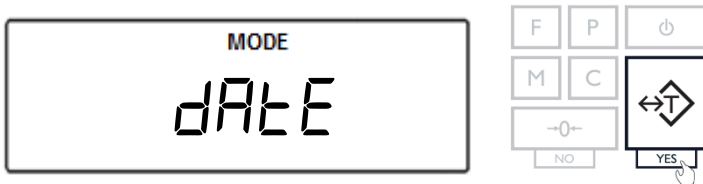

3. The current date will be displayed. To change the date, press the “T” key.

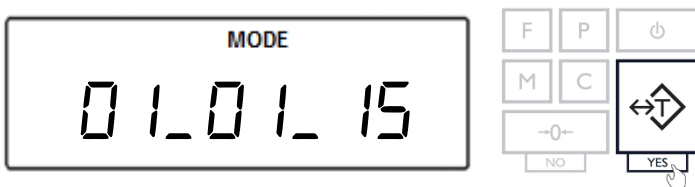

4. Use the →0← key to change minutes and hours. Press the T key to advance and confirm the time setting.

Chapter 14: Restoring Default Factory Settings (rESEt)

The Reset function resets all modes and applications as well as restores default factory settings. To restore default factory settings follow the steps below.

1. Press the “M” key. Select “rESEt” by pressing the “T” key.

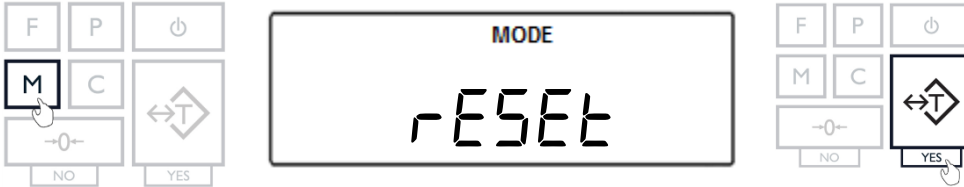

2. “YES-n0” will appear on the screen. To confirm and initialize the reset function, press the “T” (YES) key. To cancel and abort the reset press the “→0←” (NO) key.



Warning: Resetting the scale will restore the default factory setting. Stored values will be lost and all functions will be disabled.

Table 14.1: Factory Default Settings

Weighing	Function: Always enabled
Animal Weighing	Function: Disabled Filtering Time: t-3 (3 seconds)
Parts Counting	Function: Disabled Sample Size: 10 pieces
Check Weighing	Function: Disabled Under Value: 0.000g Over Value: 0.000g
Display Hold	Function: Disabled
Percent Weighing	Function: Disabled Percent Reference Sample: 0.000g
Totalizing	Function: Disabled

Chapter 15: Weighing (TARE GH)

1. To enter Weighing Mode, press the “F” key. Select “TARE GH” by pressing the T key.

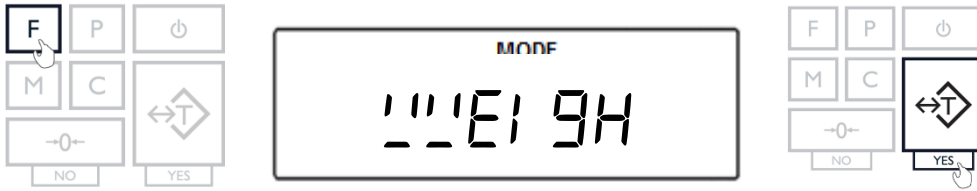

2. Wait for the stabilization indicator to appear. 



3. When weighing, always place the mass in the middle of the pan. The weighed result may be taken when the stabilization indicator reappears on the display.

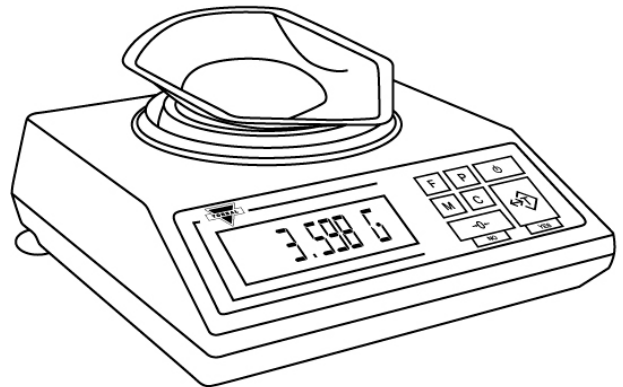

15.1 Zeroing the Scale

1. The scale is armed with the Auto Zero Setting Mechanism (AZSM). AZSM automatically maintains a center of zero condition within +/- .5d or 5mg.
2. The scale may be re-zeroed manually to obtain a new center of zero. To re-zero the scale manually with a weight that is out of the AZSM range, make sure the weight and the stabilization indicator are shown on the display.

3. Re-zero the scale by pressing the zeroing key.

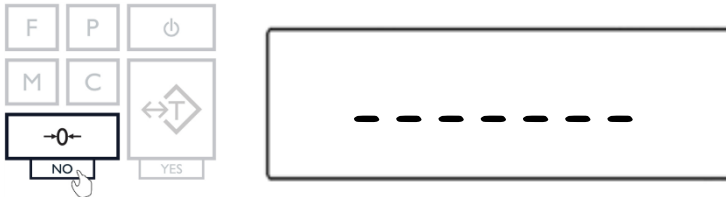

4. When finished re-zeroing, the scale will return to Weighing Mode and the display will indicate “0”. A new center of zero has been set, and the scale is ready for weighing.



Note: Re-zeroing the scale will reduce the capacity of the scale by the re-zeroed weight. The remaining capacity is displayed as a percentage on the right side of the display.

15.2 Taring the Scale

1. If a container is used for weighing, it may be tared. In taring the container, the scale subtracts the weight of the container from the gross weight to obtain the net weight.
2. To tare the weighing container, place it in the middle of the pan. The container’s weight will be shown on the display.



3. Once the stabilization indicator appears on the display, the container is ready to be tared. To tare the container, press the “T” key. The display will show a dotted line indicating that the scale has begun the taring process.

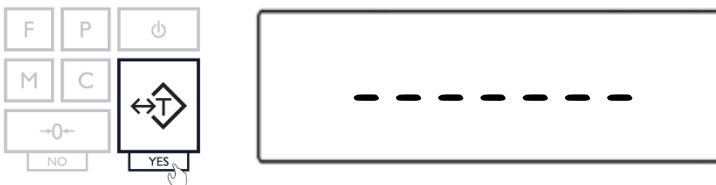

- When finished taring, the balance will return to Weighing Mode. The display will indicate “0”, and the NET indicator will be shown on the display signaling the next weight taken is a NET result.



Note: Do not touch or move the scale during the taring process.

15.3 Clearing the Tare

- To clear the tare, remove the tared object along with the NET weight from the pan. The scale will then display a negative NET tare result.



- To clear the tare, press the “T” key. The display will show dotted lines, indicating the tare is clearing.

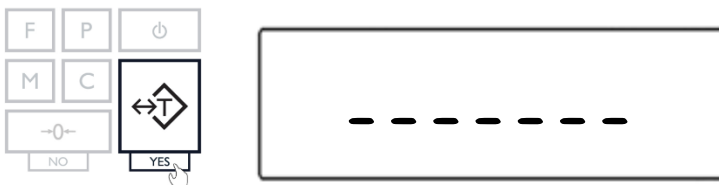

- When finished clearing the tare, the scale will return to Weighing Mode.



Chapter 16: Animal Weighing (Animal)

Animal weighing is used to weigh live animals and other dynamic loads. A choice of 3 different operating modes and 4 different weight integration periods ensures the user the best results in the least amount of time per measurement. An "A" indicator will appear on the screen to indicate the scale is in Percent Weighing mode.

1. To enter Animal Weighing Mode, press the "F" key. Select "Animal" by pressing the "T" key.

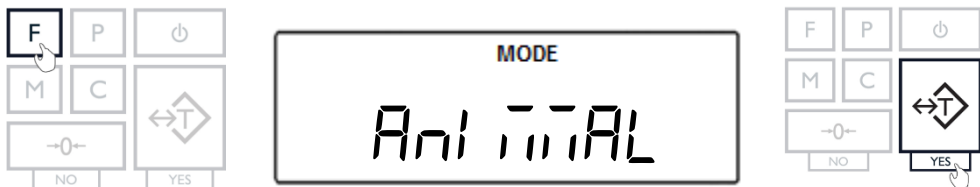

2. Place an empty weighing container on the pan. The container's weight will be displayed. Wait for the weight to stabilize and press the "T" key to tare.

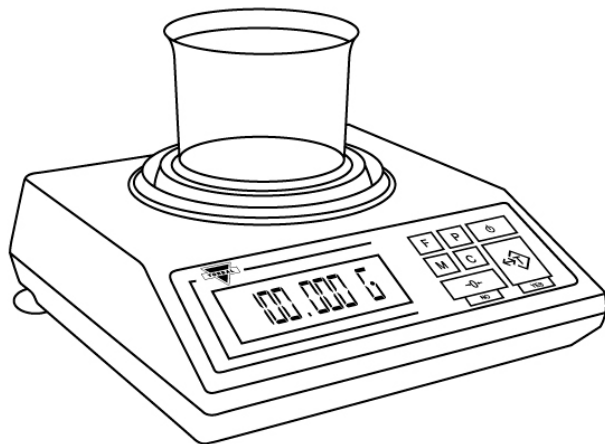
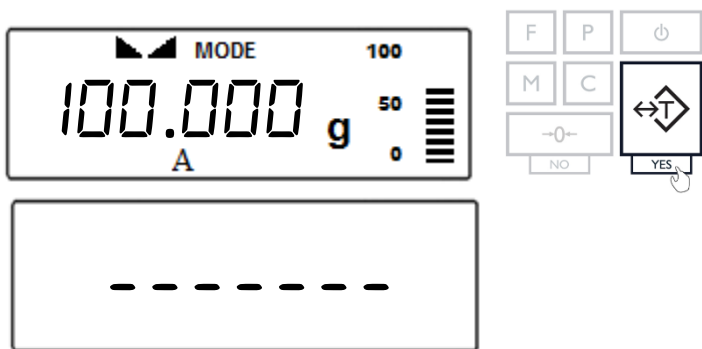

3. Once the scale has been tared, carefully place the animal into the container.

Automatic and Semi-Automatic:

When set to Automatic or Semi-Automatic, the scale will automatically begin the animal weighing process with the first weight reading.

Note: In Automatic and Semi-Automatic modes the minimum weighing mass must be equal to or greater than 10d. To see this limit expressed in grams turn to detailed specifications in Chapter 2.

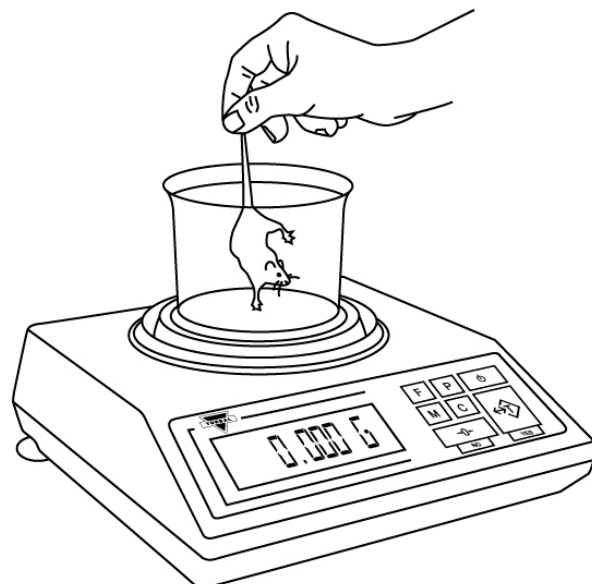

Manual:

When set to manual, animal weighing must be initialized manually by pressing the “F” key.

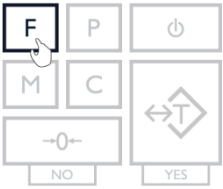

- Once the animal weighing process is initialized, the scale will display the time interval that was selected in the configuration mode and begin counting down. During the time interval the scale will record weight readings of the animal and calculate its average weight.

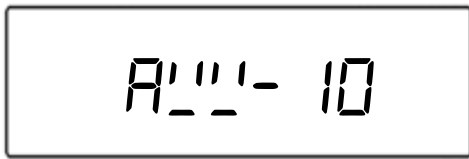
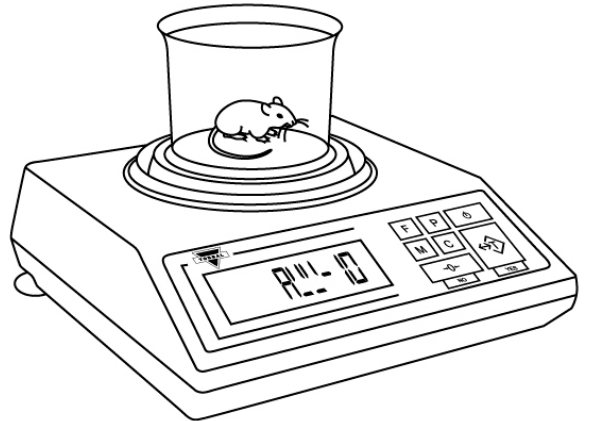

- After the time interval has elapsed the result will be displayed. The animal can now be removed from the pan.

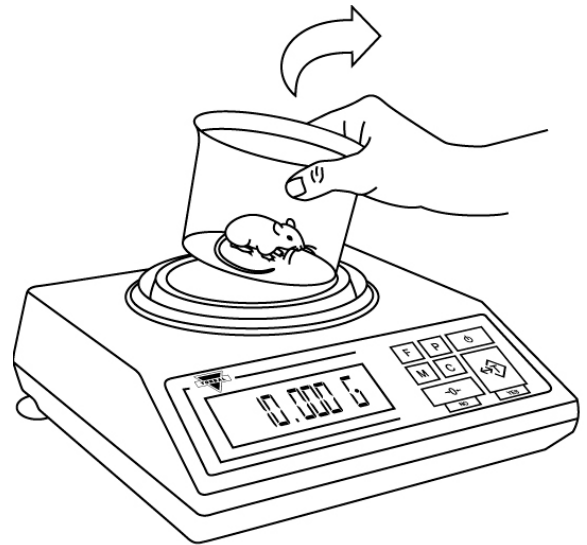

- Clear the display.

Automatic:

When set to Automatic, the result will be automatically cleared after the animal is removed. The scale will perform an automatic tare and prepare for the next weighing.

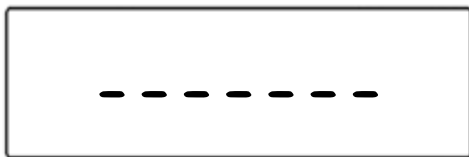

Note: If the weighing container is changed the scale must be tared manually by pressing the “T” key.

Semi-Automatic and Manual:

When set to Semi-Automatic or Manual, the weighing result will remain displayed and it must be manually cleared after the animal has been removed. To clear the weighing result, press the “C” key. After the result has been cleared, tare the scale by pressing the “T” key.

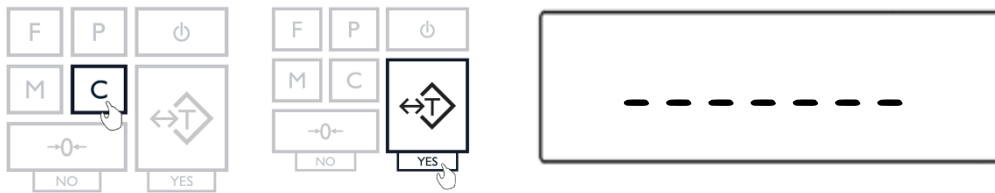

7. To exit animal weighing, press the “C” key to clear the function.

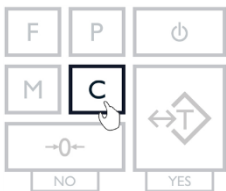

Chapter 17: Parts Counting (PARTS)

Parts Counting is used to count a batch of items based on their weight. A sample is taken to determine the average piece weight of the items. A “B” indicator will appear on the screen to indicate the scale is in Parts Counting mode.

1. To enter Parts Counting Mode, press the “F” key. Select “PARTS” by pressing the “T” key.

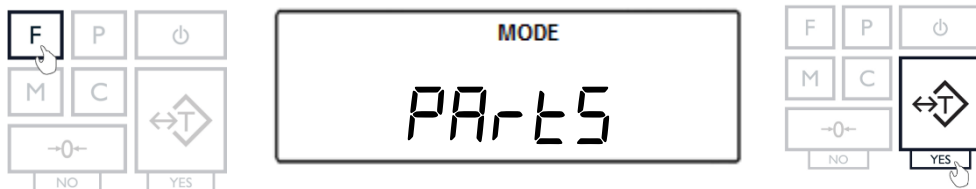

2. Place an empty weighing container on the pan. The container’s weight will be displayed. Wait for the weight to stabilize and press the “T” key to tare.

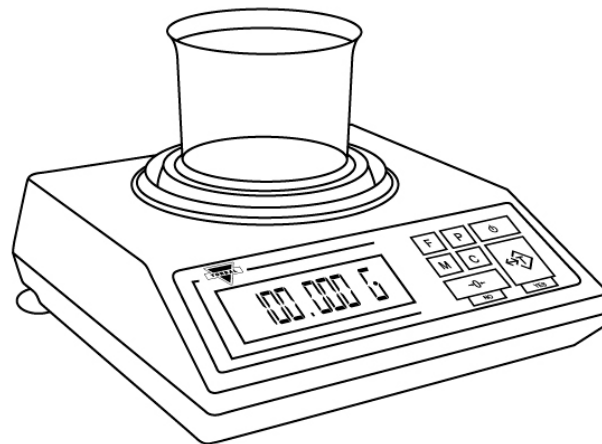
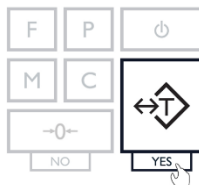
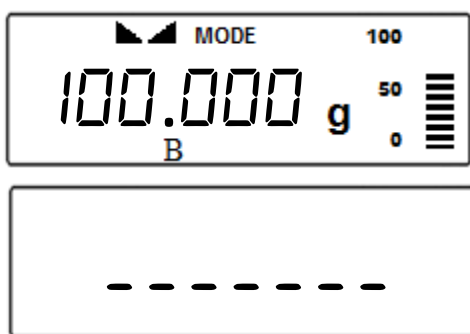

3. The default sample size that was previously configured will be displayed (**Example: SPL - 10**). To accept the sample size press the “T” (YES) key. To change the sample size press the “→0←” (NO) key.



The sample size selection ranges from 1 to 100. Quickly press and release the “→0←” (NO) key to change the sample size by increments of one. By pressing and holding the “→0←” (NO) key, the sample size will change in increments of five. Once a desired sample size is displayed, press the “T” (YES) key to accept and confirm the selection.

- After confirming the sample size, the display will read “SAPL 0n.” Place the sample into the weighing container.

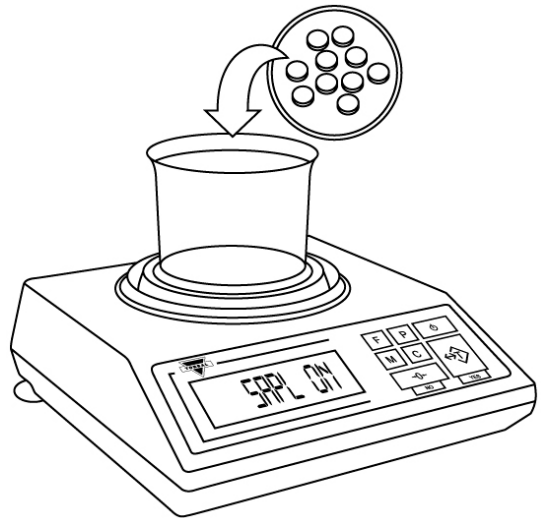
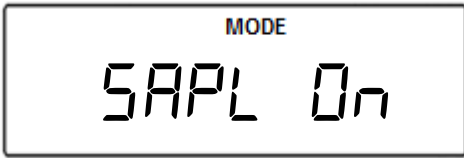

Note: Minimum individual piece weight must be equal to or greater than 3e. Attempting to set an average individual piece weight which is lower than 3e will result in a Sample Low Error (SAPL LE). To see this limit expressed in grams turn to detailed specifications in Chapter 2.

- The total weight of the sample will be displayed. Once the reading stabilizes, press the “T” key to accept the sample weight.

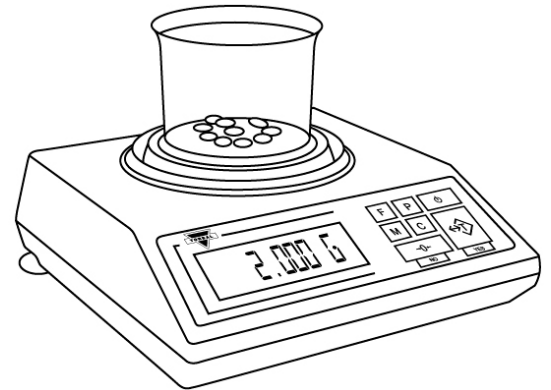
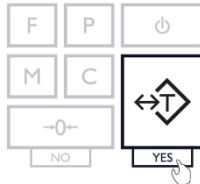
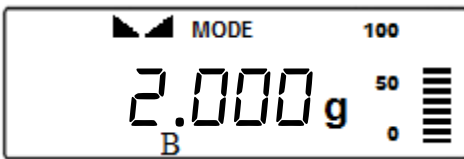

- The scale will flash “Fi LL” and then display the sample size (Example: 10 pcs) indicating to begin filling the remainder of the count. Begin to pour the pills into the container.

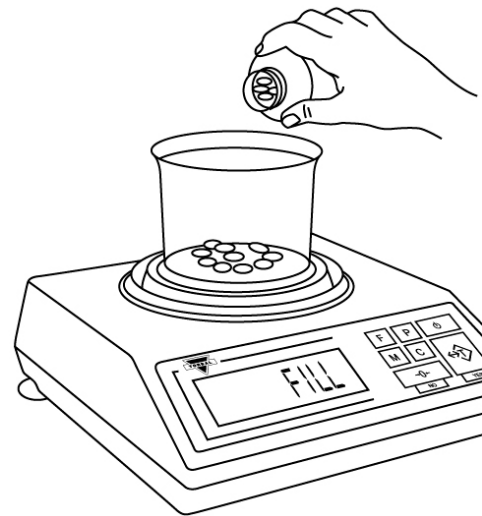
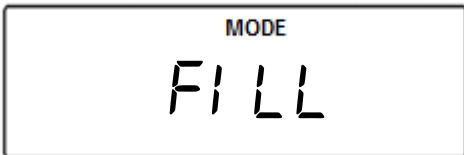

- The display will now indicate the number of pieces placed in the container. Stop filling when the desired count has been reached.

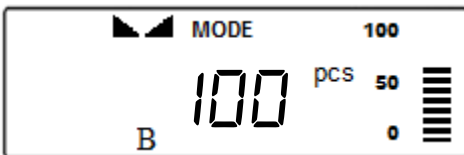



8. Once an accurate piece count has been taken, the container and its contents may be removed from the scale.

9. After the container with the counted pieces has been removed, the command “---, COUnT FI nI SH, tO StARt COUnT PrESS C” will appear on the display sequentially. Press the “C” key to begin a new count.

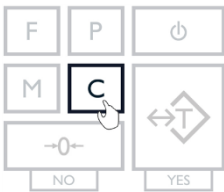
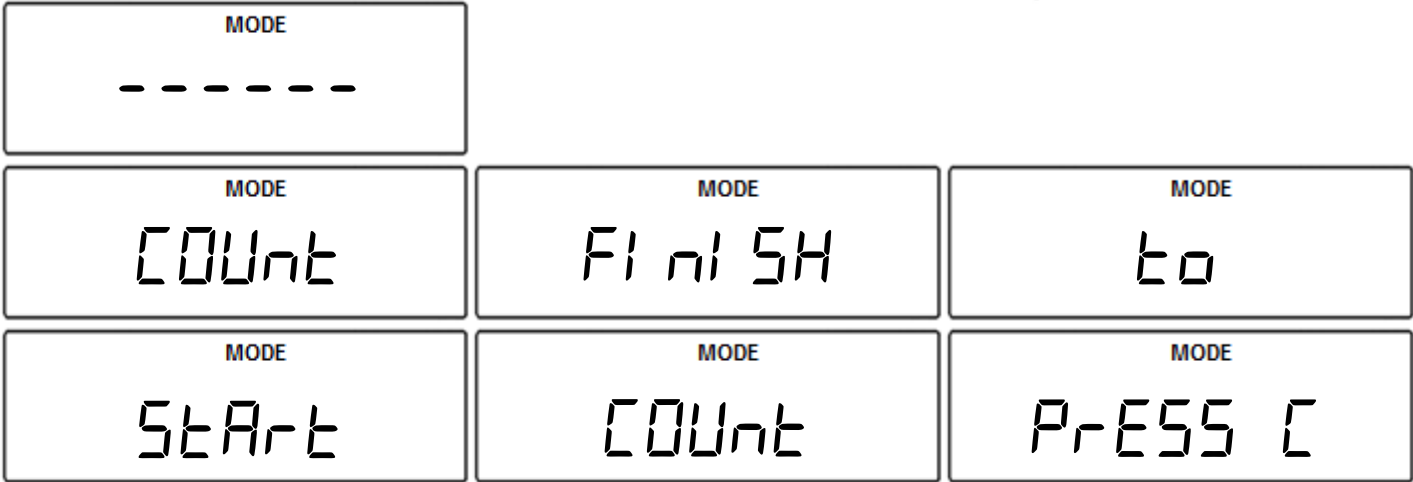
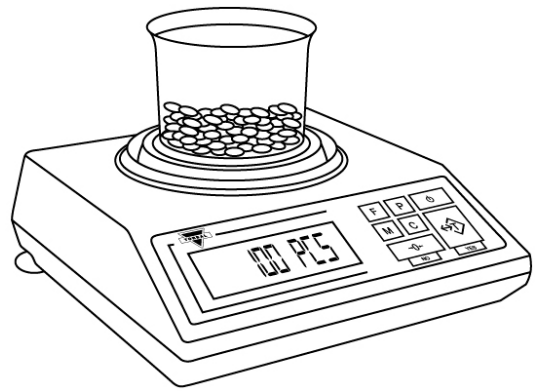

Note: If too many pieces have been placed into the container, remove the excess while the container is still on the scale’s pan. You may also remove the container from the pan, remove the extra pieces, and place it back on the pan to recheck the count. This may be performed while command “---, COUnT FI nI SH, tO StARt COUnT PrESS C” is displayed, but before pressing the “CLR” key. Once the “CLR” key is pressed the counting operation will reset.

10. To exit Parts Counting, press the “C” key to clear the function.

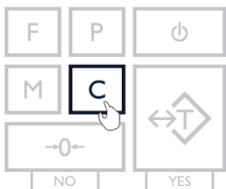

Chapter 18: Check Weighing (CHECK)

The check weighing function is used to compare the weight of an object against a preset target range. To set the limits and use the check weighing function follow the steps below. A “C” indicator will appear on the screen to indicate the scale is in Check Weighing mode.

1. To enter Check Weighing Mode, press the “F” key. Select “CHECK” by pressing the “T” key.

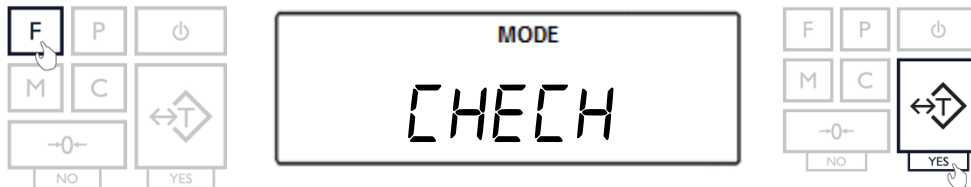

2. The current, set UNDER-limit and the command “UndEr” will appear on the display sequentially. To accept the current UNDER-limit, press the “T” (Yes) key. To change the limit, press the “→0←” key.

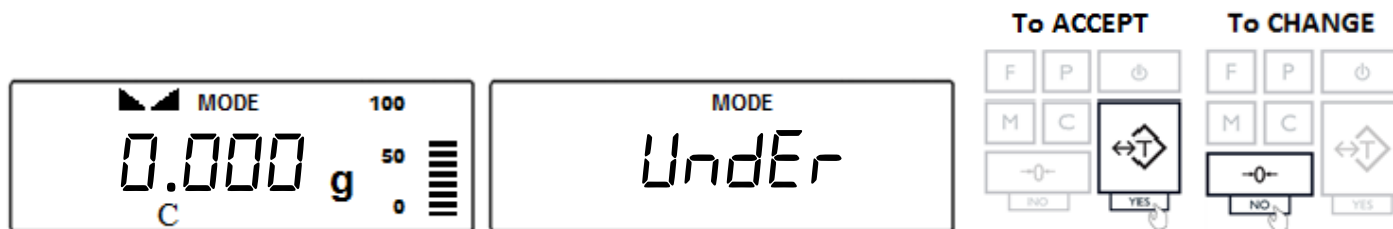

Note: The UNDER-limit displayed will be from the last time the function was used. If this is the first time the Check Weighing function is used, the limit will be set to 0.000g.

To enter a weight, use the following keys: the “→0←” (NO) key to increment a digit; “T” (YES) key to accept and go to the next digit; “P” key to insert a decimal; “FUNCTION” key to accept the entire setting; and “CLR” key to clear and start over . To become familiar with setting the weight limits, see **Table 16.1**.

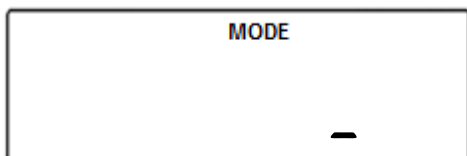
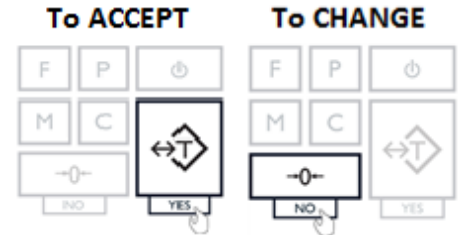
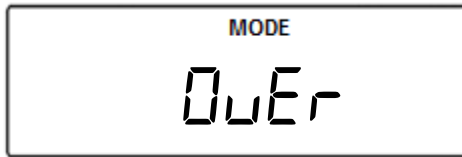
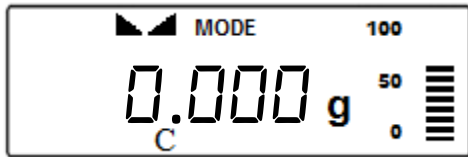

Table 18.1; Example: Setting a weight limit of 20.123g

Current display	Action to take	Key to use	Number of depressions	Display becomes
-	Increment the digit	→0← (No)	3	2
2	Accept and go to next digit	T (Yes)	1	20
20	Insert a decimal	Print	1	20.0
20.0	Increment the digit	→0← (No)	1	20.1
20.1	Accept and go to next digit	T (Yes)	1	20.10
20.10	Increment the digit	→0← (No)	2	20.12
20.12	Accept and go to next digit	T (Yes)	1	20.120
20.120	Increment the digit	→0← (No)	3	20.123
20.123	Accept the entire setting	FUNCTION	1	--

- After setting the *UNDER*-limit, the current, set *OVER*-limit and the command “*OVER*” will appear on the display sequentially. To accept the current *OVER*-limit, press the “T” (Yes) key. To change the limit, press the “→0←” key.



Note: The *OVER*-limit displayed will be from the last time the function was used. If this is the first time the Check Weighing function is used, the limit will be set to 0.000g.

To change the *OVER*-limit, follow the directions in **Steps 3 - 4** of this section and **Table 18.1**.

- Once both limits have been set the scale will display “*TARE*”. Place a container on the pan and press the “T” key to tare.

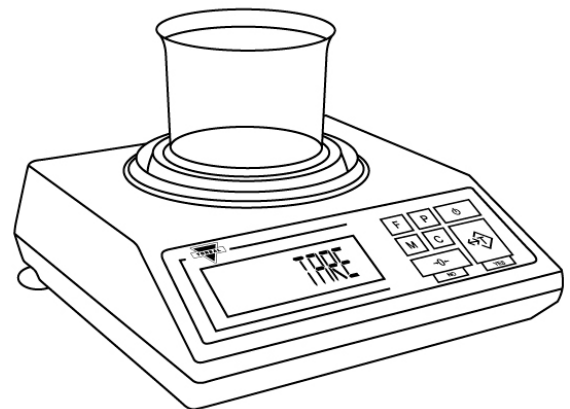
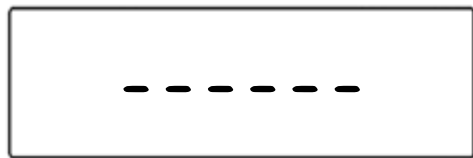
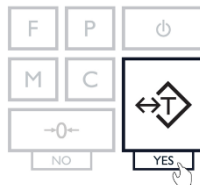
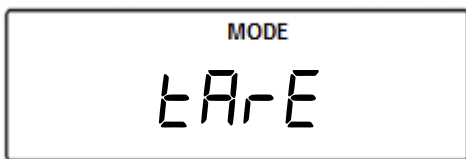

- The scale is now ready to use. To perform check weighing place your object on the pan to check whether the weight of the object falls within the designated range. If the weight is less than the lower limit the scale will display the weight of the object and the command "UndEr". If the weight falls within the range, the "ACCEPt" command will be displayed. If the weight exceeds the upper limit, the scale will display "OuEr".

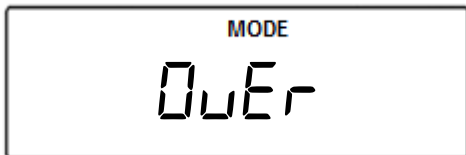
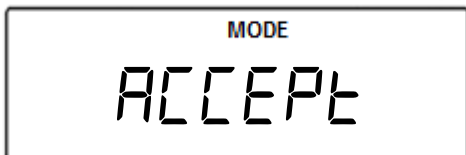
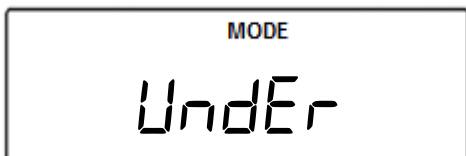
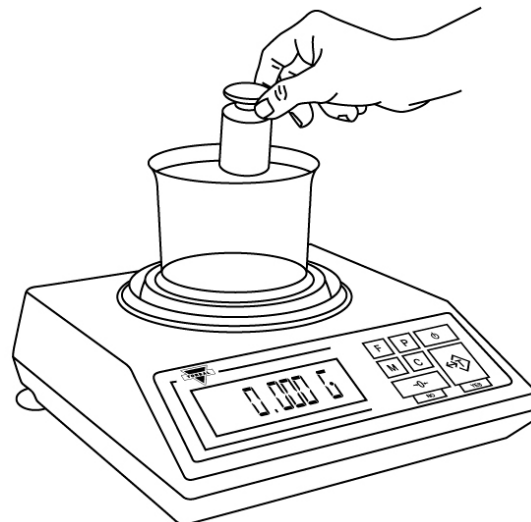

Note: To change the limit setting press "CLR" and repeat Steps 1 to 7. If the same limits are used, the scale can be tared without clearing the function and the new object can be weight-checked.

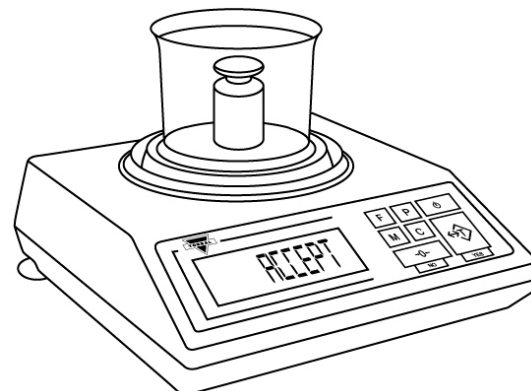

- To exit Check Weighing, press the "C" key to clear the function.

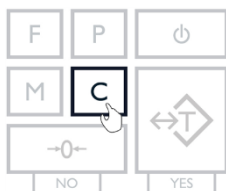

Chapter 19: Display Hold (dI SPLAY)

Display Hold is used to lock a weight reading on the screen, even after the weighed object has been removed from the pan. A “D” indicator will appear on the screen to indicate the scale is in Display Hold mode.

1. To enter Display Hold Mode, press the “F” key. Select “dI SPLAY” by pressing the “T” key.

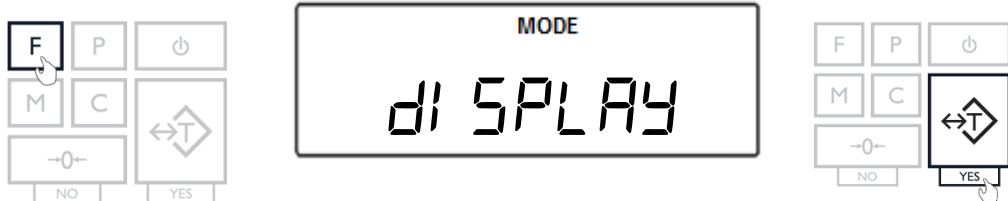

2. Place an empty weighing container on the pan. The container’s weight will be displayed. Wait for the weight to stabilize and press the “T” key to tare.

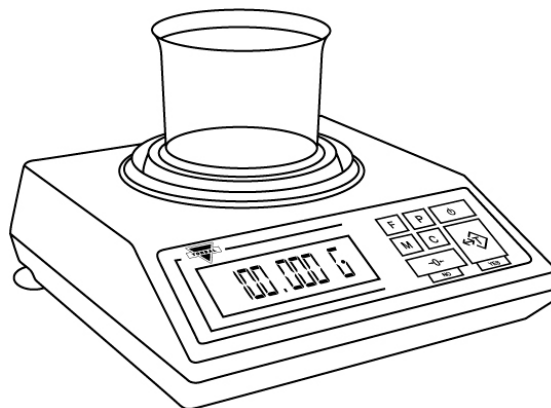
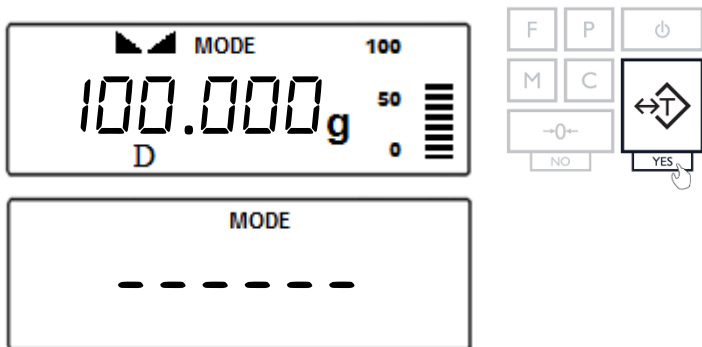

3. Place an object into the container.

Automatic and Semi-Automatic:

When set to Auto or Semi-Auto, the scale will automatically lock the weighing result on the screen after it stabilizes. A display locked indicator will appear on the screen.

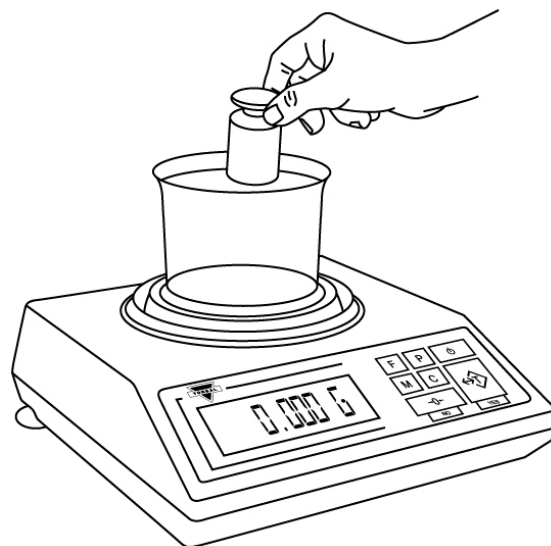
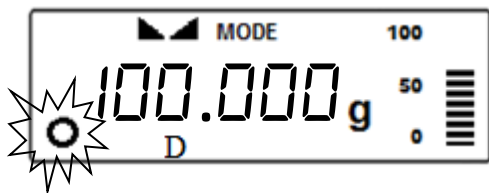

Note: In Automatic and Semi-Automatic modes the minimum weighing mass must be equal to or greater than 10d. To see this limit expressed in grams turn to the detailed specifications in Chapter 2.

Manual:

When set to Manual, press the “F” key to lock the result on the screen.

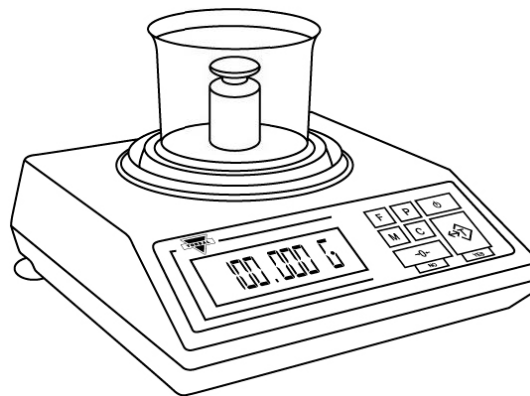
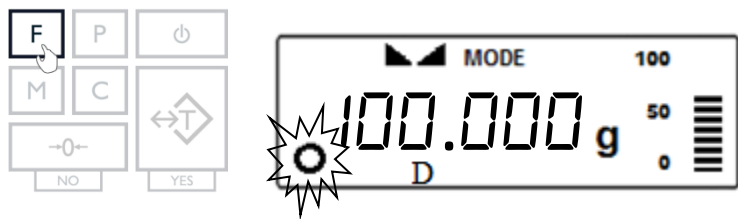

4. Clearing the display

Automatic:

When set to Automatic, the scale will automatically clear the result from the screen when the weight is removed from the container. The scale will perform an automatic tare and prepare for the next weighing.

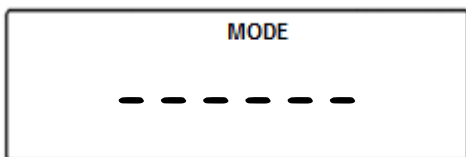

Note: If the weighing container is changed the scale must be tared manually by pressing the “T” key.

Semi-Automatic and Manual:

When set to Semi-Automatic or Manual, press the “C” key to remove the weighing result from the screen. Press the “T” key to tare the scale.

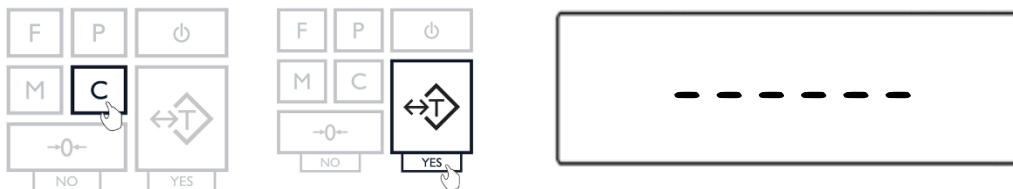

5. To exit Display Hold, press the “C” key.

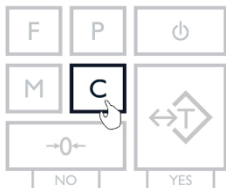

Chapter 20: Percent Weighing (PERCENT)

Percent Weighing is used to compare the relative weight of an unknown item to that of a previously stored sample. An “E” indicator will appear on the screen to indicate the scale is in Percent Weighing mode.

1. To enter Percent Weighing Mode, press the “F” key. Select “PERCENT” by pressing the “T” key.

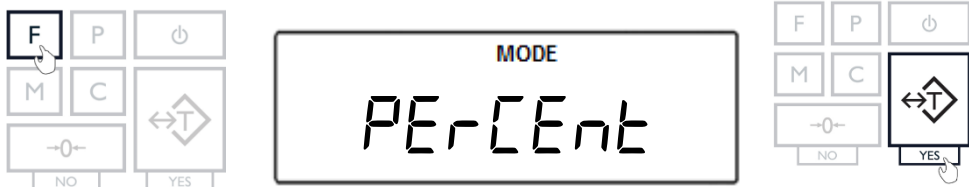

2. Place an empty weighing container on the pan. The container’s weight will be displayed. Wait for the weight to stabilize and press the “T” key to tare.

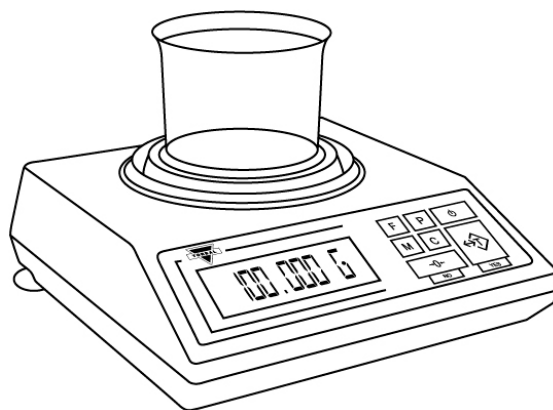
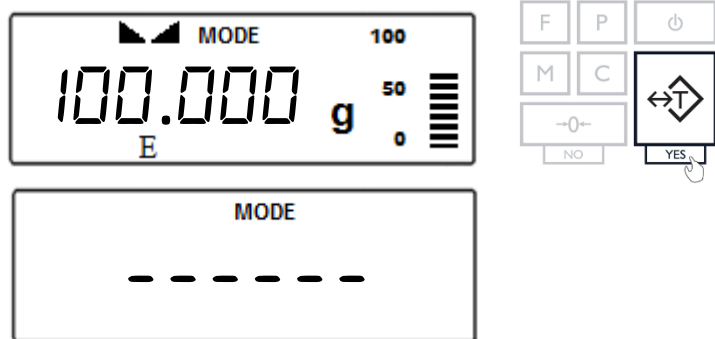

3. The scale will display the weight of the previously stored sample and the command “SAMPLE” sequentially. To accept the current sample weight, press the “T” (Yes) key. To change the sample weight, press the “→0←” key.

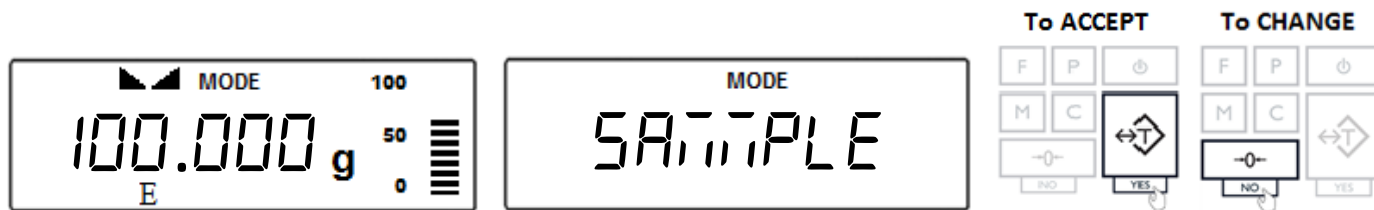

Note: If this is the first time the function is used, the sample weight will be 0.000g.

To change the sample weight, place a new sample in the weighing container when "SAPL 0n" is displayed. Once stabilized, press the "T" (Yes) key to accept the new weight.

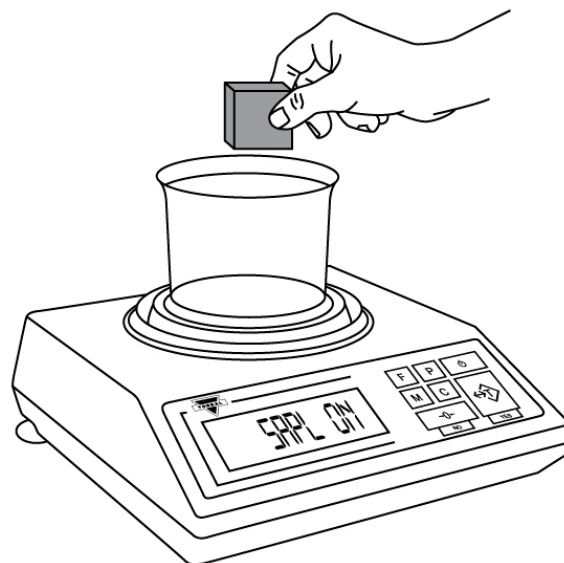
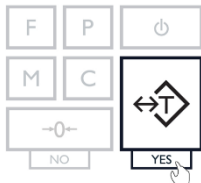
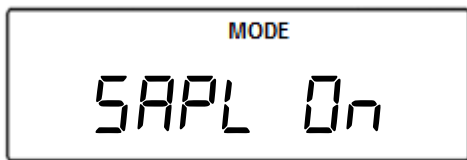

Note: The reference sample must be equal to or greater than 100d. Attempting to set a sample lower than 100d will result in a "SAPL L0" error.

4. After setting the sample weight, the command "rEAdy" will be displayed. Remove the sample and place the object on the pan.

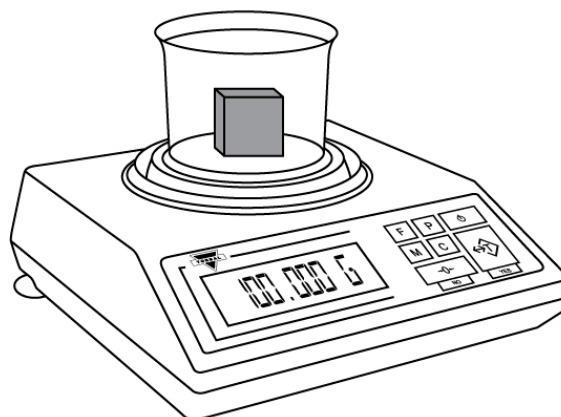
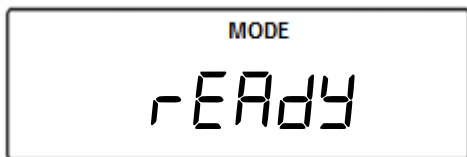

5. The scale will express the weight of the object as a percentage of the stored sample.

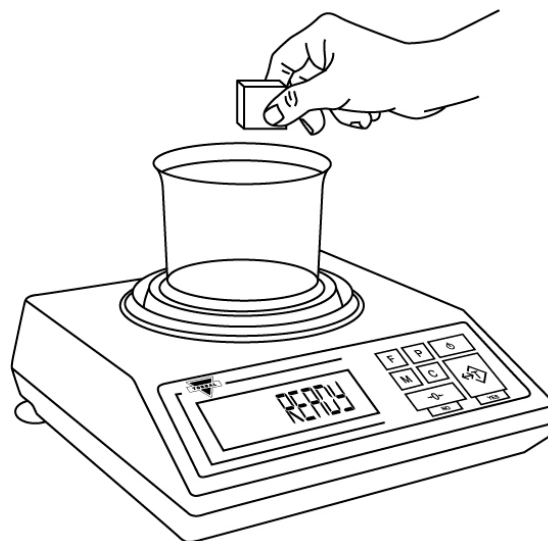
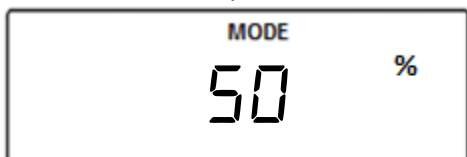

Note: To change the initial sample press “CLR” and repeat Steps 1 to 3.
 If the same sample weight is used, the scale can be tared without clearing the function and new objects can be weighed.

6. To exit Percent Weighing, press the “C” key.

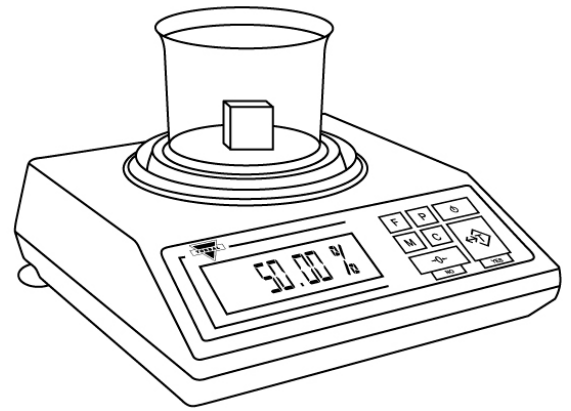
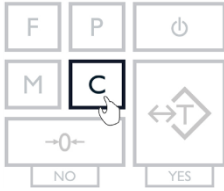

Chapter 21: Totalizing (TOTAL)

Totalizing is used to calculate the summation of multiple weights that are recorded sequentially. An “F” indicator will appear on the screen to indicate the scale is in Totalizing Mode.

1. To enter Totalizing Mode, press the “F” key. Select “TOTAL” by pressing the “T” key.

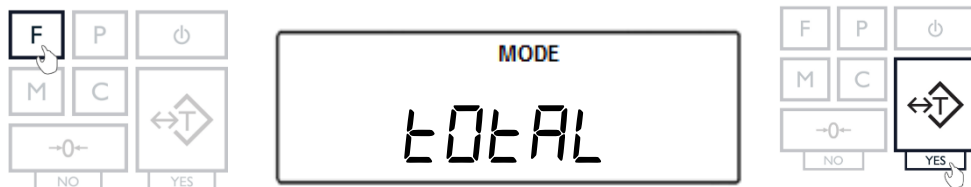

2. Place an empty weighing container on the pan. The container’s weight will be displayed. Wait for the weight to stabilize and press the “T” key to tare.

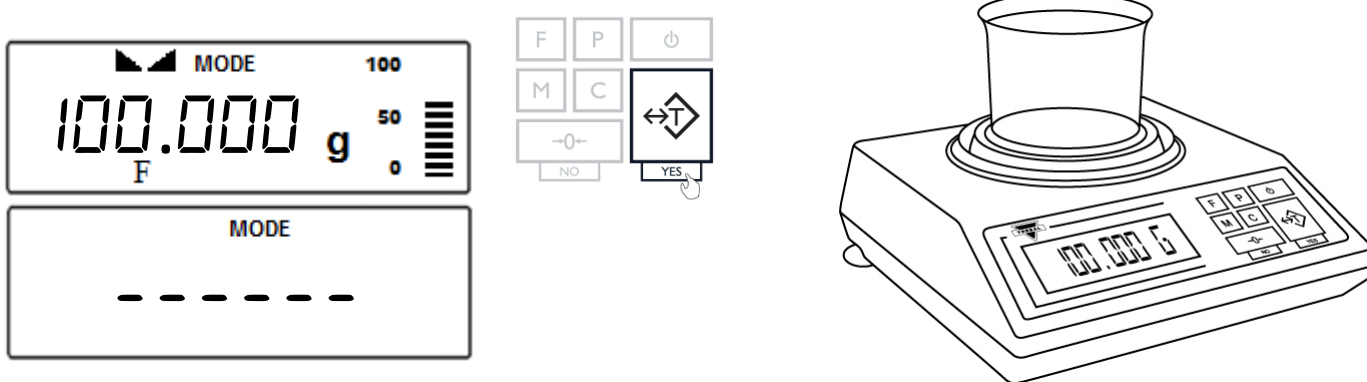

3. Place the first object in the container.

Automatic and Semi-Automatic:

When set to Auto or Semi-Auto, the weight of the object will be added to the total automatically. A TOTAL indicator will appear on the display.

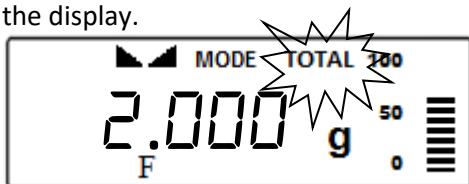

Note: In Automatic the minimum weight must be equal to or greater than 10d

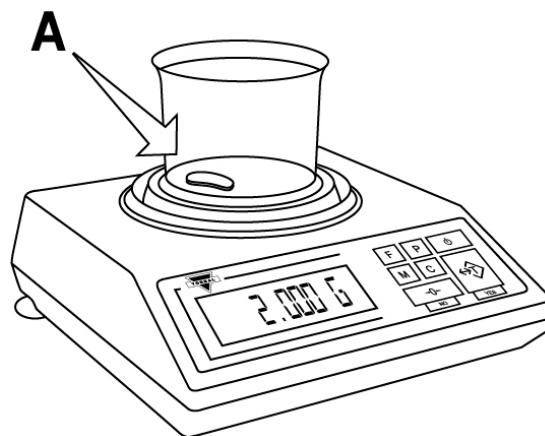

Manual:

When set to Manual, press the “F” key to add the weight to the total. A *TOTAL* indicator will appear on the display.

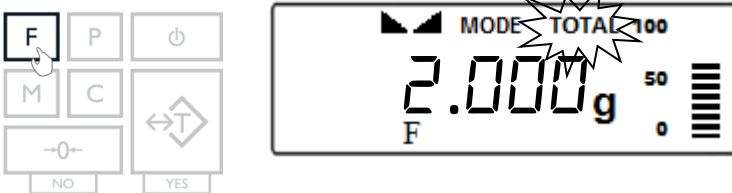

Note: With each added weight, the grand total result will appear on the display for approximately three seconds. To recall the grand total at any time, press the “M” key.

- Once a weight has been added to the total, remove the object from the pan or press the “T” key.

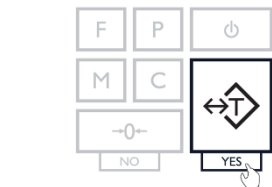
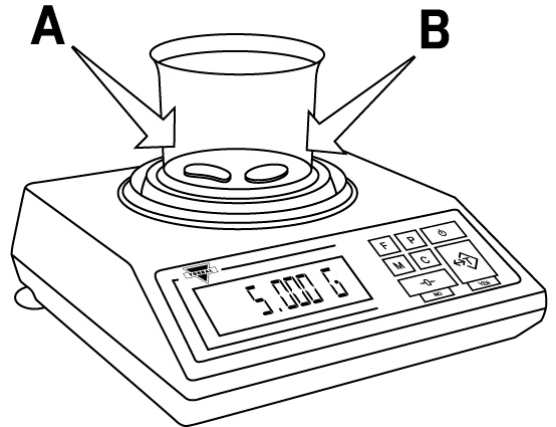

- Repeat **Steps 3 – 4** for the remainder of the samples.

- To clear the grand total and reset the function press the “C” key. “YES-NO” will appear on the display. To clear the function, press the “T” (Yes) key. To cancel the clear, press the “→0←” key.

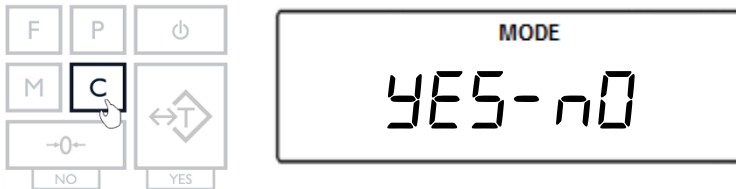
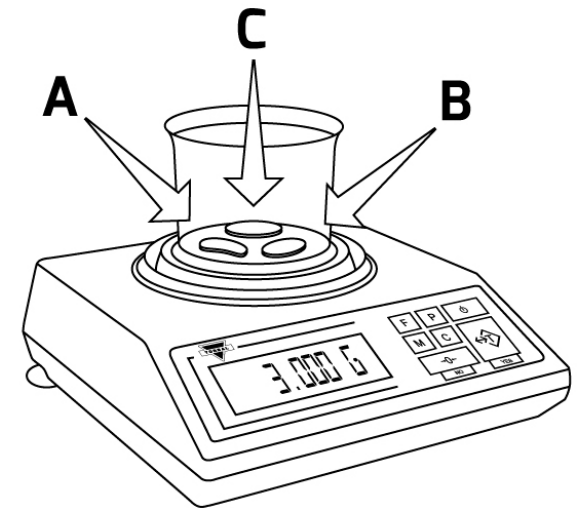

To ACCEPT

To CHANGE

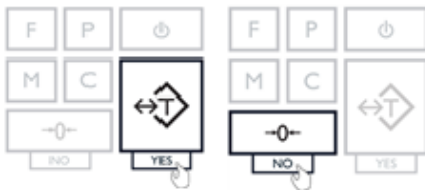

- To obtain the total press the MAENU key. To reset the compounding function and start a new recipe press the CLR key again while the total is displayed.

- To print the recipe, press the P key.

Chapter 22: Sealing the Calibration Switch (Legal for Trade models only)

Depending on individual state law, the calibration feature of the scale may be required to be sealed by an NIST/NTEP official. To seal the calibration feature, follow the instructions below.

The scale can be sealed in two ways by using either a paper seal or a wire seal.

Paper Seal:

1. To seal the scale using a paper seal or a sticker, use a flathead screwdriver to gently remove the calibration wire seal screw located in the rear of the scale.
2. Once the wire seal screw has been removed and the calibration switch exposed, gently insert the flush sealing screw provided with the scale in the place of the wire seal screw.

Warning: Do not attempt to screw the flush sealing screw all the way in. Stop when the screw is flush with the casing of the scale.

3. Once the flush sealing screw is in place, apply the paper seal over it, so that it completely covers the flush screw.

Wire Seal:

1. To seal the scale using a wire seal, insert the wire into the opening of the calibration wire seal screw.
2. Insert one end of the wire through the opening in the fixed rear foot located underneath the scale.
3. Bring both ends of the wires together and close the wire loop with a seal. Do not attempt to remove the calibration screw as it will rip the wire and break the seal.

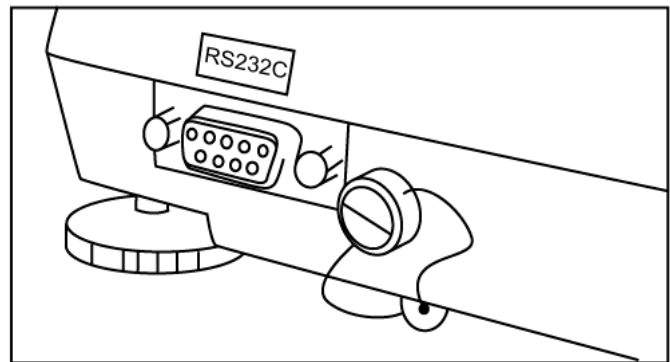
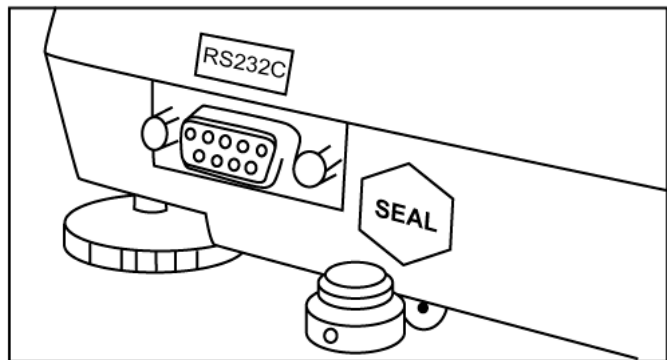
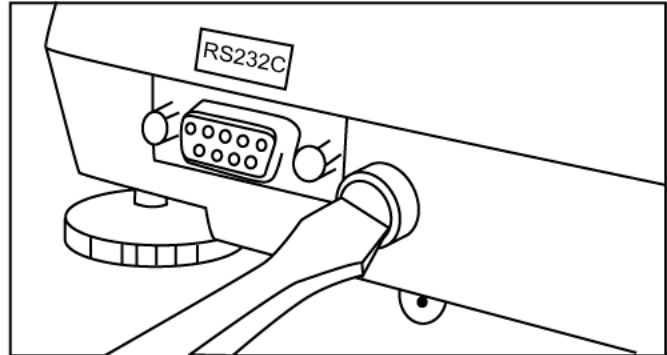

Chapter 23: Common Errors and Trouble Shooting

Error or Indicator	Cause	Explanation / Solution
----	Below Zero	Re-zero the scale by pressing the “→0←” key.
--	Taring is not allowed	Place a weight on the pan before taking a tare.
- -	Re-zeroing is not allowed	Remove weight from the pan and clear stored tare values
L	Pan error	Make sure the pan is properly seated on the pan support.
H	Exceeded capacity	The scale has exceeded its weighing capacity. Reduce the weight.
Err – b	Pan not cleared on power-up	The pan was not empty while the scale was initiating at startup. Clear the pan and restart the scale.
Sapl LO (Parts Counting)	Average piece weight is too low	The average piece weight is lower than 3e. Be sure that individual piece weight is greater than 3e.
Sapl LO (Percent Weighing)	Sample reference weight is too low	The sample reference weight is lower than 100d. Increase the sample weight.
The scale will not turn on	Possible power failure	Check the power AC adapter connection.
Weighing results are not accurate	Inaccurate calibration	Calibrate the scale.
Weighing results are not stabilizing	Irregular environment	Eliminate drafts or vibrations.

Chapter 24: Maintenance

Cleaning and maintaining your Prescription Scale:

- Before cleaning the scale always unplug the A/C adapter from the electrical outlet.
- Use a soft, slightly damp cloth to clean the exterior housing of your scale.
- Wipe the scale gently. Do not allow any liquid to enter into the scale.
- Do not apply extensive pressure to the LCD display.
- Do not use chemicals or benzene when cleaning the surface. Corrosive chemicals may damage the finish.
- Alcohol may be used only to clean the scale's stainless steel pan or the draft ring.

Chapter 25: Accessories

Description	Part No.
Draft Shield Cover (Select Models Only)	301086
Dust Cover	301056
RXP-4 Thermal Printer	301060
RS232 PC Cable	301058

Chapter 26: Replacement Parts

Description	Part No.
A/C Adaptor	301054
Pan (115mm)	501094
Pan Base	501095
RS232 Printer Cable	-



Chapter 27: Limited Warranty

PURCHASER'S WARRANTY

Warranty is valid only if your product has been registers within 30 days of receipt

This product is a precision device made to exacting standards of scientific accuracy. It is guaranteed to have been adjusted and inspected for proper workmanship and performance, and certified for its currently advertised specifications before shipment. Scientific Industries' Products are warranted against defects in material and workmanship under normal use and service. This warranty is extended only to the first purchaser. This limited warranty will not apply if, upon inspection, it is found that the product was tampered with, misused, overloaded, or abused, mishandled, placed in an improper environment, improperly installed or adjusted, used for a purpose other than that for which it was designed, or repaired by unauthorized personnel. Scientific Industries' liability under this warranty is limited to furnishing labor and parts necessary to remedy the defect covered by this warranty and restore the product to normal operating condition. Purchasers may be charged a minimum repair fee for in-warranty products returned for repair if those products are determined to be problem-free. To make a claim under this limited warranty, you must first obtain an RMA number from Scientific Industries and return the product carefully packed, in its original packaging, shipping prepaid, with the RMA number written on the return package.

EXCEPT FOR THE LIMITED WARRANTY PROVIDED HEREIN, ALL OTHER WARRANTIES, EXPRESS AND IMPLIED, INCLUDING MERCHANTABILITY AND FITNESS FOR A PARTICULAR PURPOSE, ARE DISCLAIMED. In all events, consequential, incidental, special and other damages are excluded and Scientific Industries, Inc. shall have no liability beyond the repair or replace limited warranty provided above.



SI *Division of*
Scientific Industries, Inc.

Scientific Industries, Inc.

80 Orville Dr.

Bohemia, NY 11716

Tel. (973)473-6900

Fax. (973)777-8302

www.torbalscales.com