

Air Mini Grinder "KUJIN"



Instruction Part No. GR-M58 (75) KS Throttle Type
GR-M58 (75) KL Lever Type

Thank you for purchasing our product!
Please read all instructions carefully before using the product to ensure safe and proper use. After reading this instruction, please save it and make them available to users of this tool.

Record your purchase information here for quick reference.	Retailer Name		
	Phone ()		—
	Purchase Date		
Year and month of manufacture (Marked on a main body)	2 0		—
Serial Number			

Contact

New Registon Co., Ltd.

Address: 2-1-1 Ayumino, Izumi, Osaka 594-1157 JAPAN

Phone: +81(725)51-2292

Fax: +81(725)51-2392

Website: <http://www.newregiston.co.jp/>

Diagram and Parts List

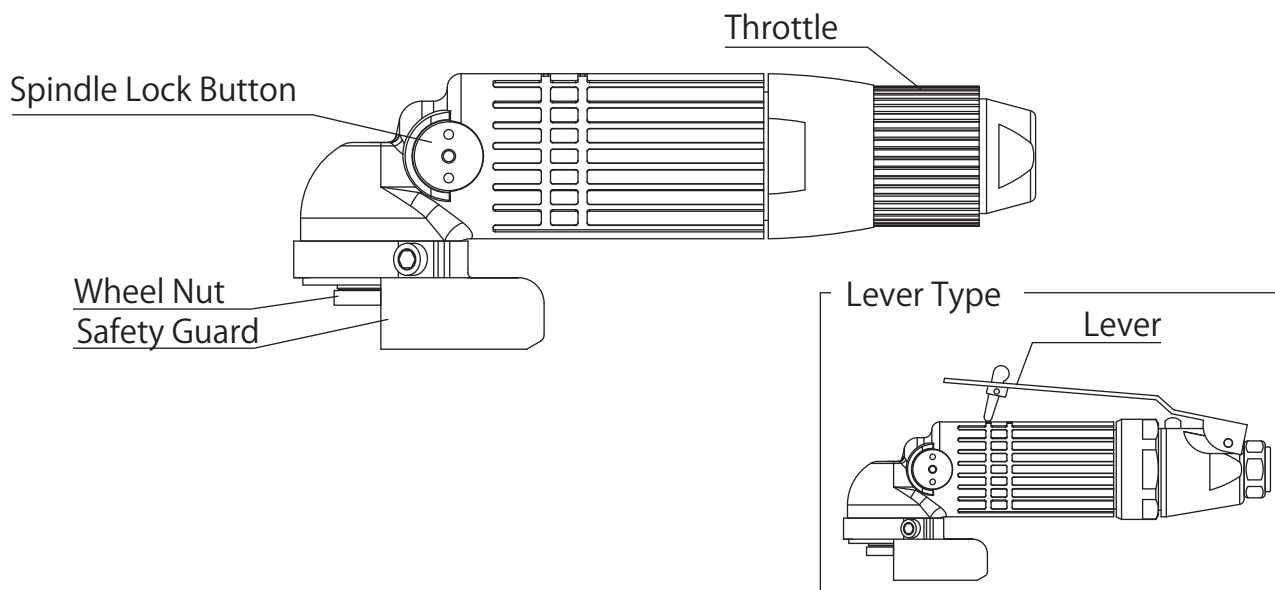

Specification

Model	Throttle Type: GR-M58 (75) KS
	Lever Type: GR-M58 (75) KL
Wheel Size	58x3.5x9.53mm
	75x4x9.53mm
Operating Air Pressure	0.6 MPa (6 kgf / cm ²)
Air Consumption	0.54 m ³ / min
No Load Speed	12,500 min ⁻¹
Basic Machine Mass (including safety guard and wheel nut for 58mm wheel)	Throttle Type: 0.54kg
	Lever Type: 0.59kg
Overall Length	160mm
Diameter of Grip	36mm
Switch Type	Throttle / Lever
Noise Level	85dB

Accessories

Safety Guard for 58mm wheel(Attach to main body)

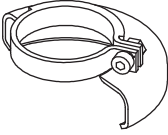

Safety Guard for 75mm wheel

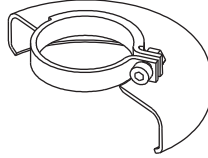

Wheel Nut for 58mm wheel (Attach to main body)



Wheel Washer for 75mm wheel



Wheel Nut for 75mm wheel



Air Plug (For round 1/4 inch)



Hexagon wrench (Opposite side distance 5mm) for wheel nut replacement



Hexagon wrench (Opposite side distance 3mm) for safety guard replacement



Oil



Wheel Nut for 58mm wheel

Grinding Wheel ↓

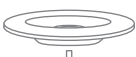

Adapter for 58mm wheel



※ Please attach the adapter as needed, when using the 58mm wheel.

Spindle ↓



※Specifications (including design) may change without notice.

BEFORE USE



**WARNING:READ AND UNDERSTAND ALL INSTRUCTIONS BEFORE USE.
MAKE SURE TO DO THE FOLLOWING 1 TO 5 BEFORE CONNECTING TO AIR HOSE.**

1. Set an operating air pressure.

Set the air pressure against the established operating air pressure marked on the main body. Failure to set the proper operating air pressure can cause a wheel / grinder breakage and an accident.

2. Be sure power switch is in the "OFF" position.

Avoid accidental starting. If the grinder is connected to air hose while the switch is in the "ON" position, the tool will start accidentally and invites accidents.

Always make sure the lever / throttle is in the "OFF" position before connecting air supply.

3. Always use a safety guard.

A safety guard protects operator from broken wheel fragments. Always make sure a safety guard is in place. The angle of safety guard can be adjusted by loosening screw. Tighten the screw properly after adjustment.

Caution: Use a proper safety guard which matches the wheel size.

4. Check a spindle lock.

Make sure that the spindle lock button is disengaged by pushing spindle lock button.

5. Check and Mounting Wheel

Use an authentic wheel. Do visually inspect the wheel before mounting for possible damage, such as cracking or chipping. Make sure the wheel is mounted and tightened properly.

6. Perform a Test Run

The use of cracked or chipped wheel is very dangerous. Always perform a test run in a safe place to make sure there are no problems.

Duration of the test run

When starting daily work	1 minute or more
When grinding wheel is replaced	3 minutes or more

Caution: Always make sure the rotating part does not contact with a workpiece before turning on the power.

When you attach a new grinding wheel and switch on the tool for the first time, please keep your body away from exposure parts of grinding wheel by all means.

Mounting and Removing a Grinding Wheel



WARNING:ALWAYS DISCONNECT THE AIR HOSE FROM THE TOOL BEFORE MOUNTING OR REMOVING A WHEEL.

1. Mounting a Wheel

- Tighten the wheel nut by using the supplied wrench.
- Make sure to use the supplied wheel washer and wheel nut together with 75mm wheel.
- Use a proper safety guard which matches wheel size.

[Mounting 58mm wheel]

- Turn the grinder upside down so that the spindle is facing upward.
- Fit the protuberance of wheel nut onto the wheel and screw the wheel nut onto the spindle.

[Mounting 75mm wheel]

- Turn the grinder upside down so that the spindle is facing upward. Align the wheel washer with the notched parts of the spindle, and then attach them.
- Fit the protuberance of wheel nut onto the wheel and screw the wheel nut onto the spindle.

2. Removing a Wheel

To remove the wheel, simply reverse the above-mentioned procedure.

Caution: Make sure that the spindle lock button is disengaged by pushing spindle lock button.

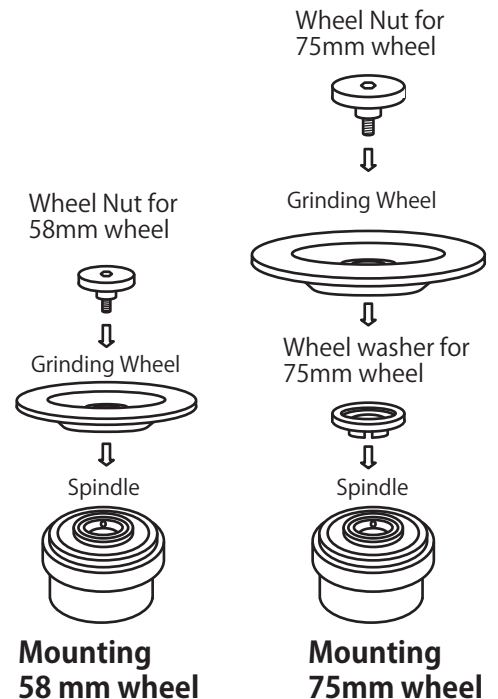

Mounting a Optional Accessory

- Please follow the instructions of each product to mount the optional accessories properly.
- Always make sure to use protective equipment with the optional accessories.
- Always make sure not to exceed the maximum operating speed and maximum allowable rotation.

IMPORTANT SAFETY RULES FOR PROPER USE OF PNEUMATIC TOOL

Pneumatic tool is a safety tool if the tool is used properly. Improper use or careless handling may cause accidents such as fire, electrification and injury. Please follow the rules below for your safety. The following safety rules are based on Japanese "Industrial Safety and Health Standard" and "Grinding Machine



WARNING: IMPROPER USE MAY CAUSE DEATH OR SERIOUS INJURY.

Do's

1. Make sure to drain water from air filter and compressor before and after using the tool. Increase of moisture in the compressed air may result in rotating speed of grinder over rated speed. Moisture control system is required. Be extra careful to use tool in winter. Moisture may freeze in an air passage or exhaust port, and cause capacity degradation.
2. Watch what are you doing, and stay alert when operating the tool.
3. Use safety equipment such as safety helmet, safety glasses, dust mask, ear protection, protective gloves and safety shoes.
4. Always operate a tool in accordance with all standards and regulations (local, state, country, etc.) regarding noise to prevent a trouble to neighborhood. Install sound proof wall as necessary.
5. Make sure there is no one below you when using a tool in a high area.
6. Clean the wheel nut if the surface which contact the wheel are dirty.
7. Replace the wheel nut with new one if the wheel nut cannot contact wheel' s surface properly due to wear or deformation.
8. Perform a visual inspection and a Ring test (hammering test) for checking a crack, chip or damage before use.
9. Observe the instructions for mounting grinding wheel.
10. Make sure there are no fluctuations after mounting wheel. The fluctuations may cause wheel skipping or wheel breakage.
11. Temporary tighten the wheel, check wheel nut surface contact with wheel properly and confirm that the wheel does not wobble, and then tighten wheel nut completely.
12. Use only wheels which meet the specified dimension and RPM capacity of the grinder.
13. Make sure the wheel is attached firmly after mounting.
14. Make sure the lever / throttle is in off position before plugging tool into air hose.
15. Disconnect from the air source immediately and inspect a machine and the air source carefully if the wheel rotates though the switch is in off position.
16. Turn off switch and disconnect air hose from the tool when not in use or servicing a tool, changing the wheels or accessories and other hazardous situations.
17. Perform a test run for at least 1 minute when starting daily work and for at least 3 minutes when grinding wheel is replaced.
18. Use clamp, vice or other practical ways to secure and support the workpiece to a stable platform.
19. Check rotary direction before use.
20. Check for damaged parts and use only parts recommended by manufacturer for your model when servicing a tool .
21. Be carefully checking safety guard or other parts have a damage and determine that it will operate properly and perform its intended function before using the machine.
22. Check for alignment of moving parts, binding of moving parts, breakage of parts, and any other conditions that may affect its operation.
23. Always use the air tool with holding it firmly and provide for a secure stance. Pay special attention to when turning on the switch.
24. Check the rotation speed against established maximum operating speed marked on the wheel at least one time a day.
25. Disconnect the air hose from the tool before mounting, removing or adjusting any accessory on the tool.
26. Store idle tools in a safe, dry location out of reach of children.
27. Maintain the tool with special care.
28. Observe the instructions for lubricating and changing accessories.
29. Inspect the tool periodically, if damaged, have the tool serviced by supplier.
30. Inspect an extension air hose periodically when using it, if damaged, replace it with new one.
31. Keep the grip clean, dry, and free from oil and grease at all time.



WARNING: IMPROPER USE MAY CAUSE DEATH OR SERIOUS INJURY.

Don'ts

1. Do not use the tool in cluttered benches and dark areas it may invite accidents. Keep your work area clean and well lit.
2. Do not use the tool while tired.
3. Do not wear loose clothing or jewelry. Contain long hair. Loose clothes, jewelry or long hair can be caught in moving parts. Secure long hair with nets or caps.
4. Do not use accessories that are not listed in this instruction or our catalog. Using the wrong accessories may cause an accident or injury.
5. Do not use the tool for anything other than its intended use. Use the correct tool for your application.
6. Do not get at bystanders, children and visitors while operating a pneumatic tool. Never allow them to touch a pneumatic tool or air hose.
7. Do not use high pressure gas (such as oxygen or acetylene) as a power source for this tool; it may cause abnormal combustion which can lead to explosion. Use compressed air only.
8. Do not use water or grinding fluid. The machine must be used only for dry cutting / grinding.
9. Do not point the grinder at anyone. Wheels and accessories may fly apart and cause injury.
10. Do not secure the grinder with a fixing tool like vise, it invite a risk of injury caused by wheel breakage.
11. Do not roll, drop or bump the wheel, protect the wheel from impact.
12. Do not use cracked, chipped or damaged wheel. The use of damaged wheel is very dangerous.
13. Do not replace wheel and perform test run except trained personnel.
14. Do not over tighten wheel nut.
15. Do not switch it on with attaching adjustment tools.
16. Do not use the tool if there is abnormality during a test run.
17. Do not use the tool that cannot start or stop by switch.
18. Do not carry the tool by having the lever. It may start the rotation unintentionally.
19. Do not carry the tool by having air hose. Avoid contact of air hose with sharp corner.
20. Do not start the machine until safety guard is in place, failure to use a safety guard invite a risk of injury caused by wheel breakage.
21. Do not run unnecessary no-load operation.
22. Do not use the side of grinding wheel.
23. Do not exceed the tool or accessory' s working capacity to use.
24. Do not force the tool. Do the job at the rate for which it is designed.
25. Do not operate the tool in the rain, wet area and explosive atmospheres.
26. Do not overreach. Keep proper footing and balance at all times.
27. Do not touch moving parts.
28. Do not approach hands and face to tool and rotating wheel during operation.
29. Do not put the tool down before it has come to a complete stop.
30. Do not modify this tool in any way. The tool has complied with safety standards. Consult your supplier for repair.

[Switch Operation]

1. Switch On

Throttle Type: Turn the throttle in the direction of ON slowly.

Lever Type: Press the lever in the direction of main body slowly.

※Caution! Do not rapidly power switch. It invites injury caused by wheel breakage if the wheel has problems such as cracking or chipping.

2. Switch Off

Throttle Type: Turn the throttle in the direction of OFF slowly.

Lever Type: Release the lever slowly.

※Caution! Do not rapidly power off. It invites loosening of wheel nut.

Maintenance and Inspection

1. Inspect screws on the tools

Regularly inspect all screws and ensure that they are fully tightened.

2. Inspect, Maintenance and Store Pneumatic tool

Intrusion of dirt or foreign matter cause malfunction. Turn off the cock and disconnect air hose from the tool after use and store the tool in a clean and dry place to prevent intrusion of foreign matter.

Add 2-3 drops of oil from fill opening before and after operation and run the tool for few seconds, 2-3 times without load. When using the tool for many hours, add the oil during operation.

Make sure to drain water from air filter and compressor before and after using the tool.

The tool must not be modified or disassembled by user. Consult your supplier for repair.

3. Store Machine and Accessories

Do not store the machine and accessories in the places listed below.

- × Easily accessible by children
- × Exposed to the rain or dampness
- × Damp condition is variable
- × Exposed to direct sunlight
- × Store inflammable material
- × Exposed to the risk of dropping

Air Line Connection

1. For best service, filter, oiler and regulator should be incorporated. Failure to use them can result in malfunction caused by intrusion of water or dirt from compressor into main body.

2. When installing the tool or changing air hose for the first time, make sure to install them after removing dirt in the air hose carefully.

3. Refer to the right diagram for installation of air supply line.

