



TUFF STUFF® TRAILHEAD ROOF TOP TENT



Roof Top Tent Owner's Manual

Congratulations on your purchase of an Tuff Stuff Overland Roof Top Tent. We strive to provide the ultimate camping experience for every roof top tent camper. This quality roof top tent mounts directly to your roof rack or aftermarket roof bars and can be fully setup in just a few minutes. It can be left on your vehicle year-round.

Tuff Stuff Overland tents are made with the best materials that stand up to the most extreme conditions. High quality rip stop fabrics provide excellent water and wind protection.

Most of your Tuff Stuff Overland Tent components have been fully assembled at the factory except for attaching the mounting tracks and the ladder to the base of the tent. Installation is composed of unpacking, attaching mounting tracks to the base of the tent, attaching the ladder, attaching the tent cover, and then mounting your Tuff Stuff Overland Tent onto your roof rack or after market roof bars. All the tools and hardware required for installation are included. Should you have any questions, please email support@tuffstuff4x4.com or call Customer Service at 866-220-0171



WARNING

Improper installation or use of your tent may result in serious injury or death. Follow these installation instructions carefully to ensure proper installation on your vehicle and safe use of your tent. Please check with your vehicle manufacturer for specified loading capacity of your roof rack. Not all factory roof racks or after market roof bars can safely accommodate tent models.

Getting Started

This installation manual supports all current Tuff Stuff Overland tents. The installation process varies only slightly between some models and is explained in detail within these pages.

Remove tent from box and place on a clean surface. Undo all the Velcro straps so that you can open the tent enough to unzip the door and remove the contents.



Velcro straps are located on both sides of the tent

1. Undo the Velcro straps
2. Open the tent up and all content will be inside the tent
3. Remove all bags
4. Open up like picture below
5. Make sure you have all the parts required
6. Some tents may have 2 Ladders for a double entry



1. Mounting Bolts & Chanel Sliders Qty 8
2. Steel Mount Plates Qty 4
3. Track End caps Qty 4
4. Additional Rail Support Screws Qty 4 (If required to hold rail in place)
5. Rail Mounting Bolts Qty 4
6. Ladder Mounting Brackets & Hardware Qty 2
7. 13mm/15mm Self ratcheting Qty 1
8. 10mm Wrench Qty 1
9. Tension Rods Qty 8
10. Mounting Rails Qty 2 (ELITE Qty 4)
11. Ladder Qty 1 (ELITE Qty 2)
12. Cables for Stake Qty 2
13. Storage Bag 1
14. Storage Bag for Tension Rods

Tent Orientation on Your Vehicle

There are two mounting options for the orientation of your new Tuff Stuff Overland Tent. Either the tent will open so that the ladder extends off the back of your vehicle, "off the back," or the ladder extends off the side of your vehicle, "off the side." people mostly choose to mount their tents with the ladder extending off the side of the vehicle, in "off the side" orientation.

Both works for larger vehicles, however, most cars or smaller SUV Style are better suited for the off the side option.

What are the **Benefits of "off the back" tent**

1. You can access the rear of your vehicle from inside the annex room if the tent has one
2. Fits into narrow camping spaces

Benefits of a "off the side" tent

1. Allows for bicycle racks and other tow hitch accessories to be installed without interfering with your tent.
2. Closed tent width will fit inside the roof dimensions of most cars and SUV's. i.e. the tent base will not extend beyond the roof line of your vehicle when closed.



Tent Assembly

Attaching the Mounting Rails to the Tuff Stuff Rooftop Tent

1.1. Direction of Opening

Before you fit your new rooftop tent to your vehicle, you will need to decide whether you wish to have the rooftop tent open to the back or to the side of your vehicle.

A. "Off the Back"

For most larger size vehicles opening "off the back" is preferable. The advantages of this orientation are:

The mounting extrusions need to be cut off at both ends up to the second pre-drilled hole, prior to being fitted to the base of the rooftop tent. See Diagram 1.

- leaves extra roof space for additional storage.
- with the tent open you will gain weather protection from the tent above you head when accessing the back of your vehicle.

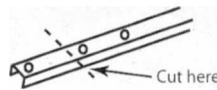

Diagram 1

The mounting extrusions are then bolted to the base of the tent at right angles to the roof rack or roof bars, in the direction of opening (along the length of the tent base).



OR

B. "Off the Side"

For most medium or small vehicles opening "off the side" is preferable. The advantages of this orientation are:

- allows for lift up tailgates to operate normally.
- means the closed tent pack is better balanced on the roof and creates less wind drag as the narrow face of the tent pack is travelling forward.

The mounting extrusions bolt to the base of the tent at right angles to the roof rack or roof bars (across the width of the tent base)



Once you have decided which is best suited to your application, follow the mounting instructions. If you are uncertain of the most appropriate method of mounting your rooftop tent, please contact TUFF STUFF who will be happy to provide advice specific to your circumstances.

Mounting Extrusion - Attachment Instructions





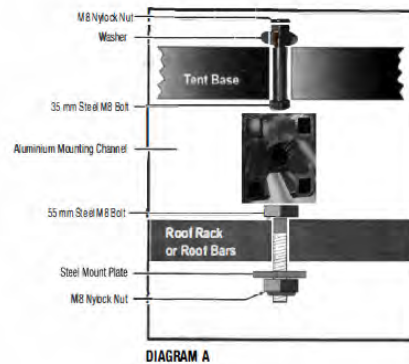



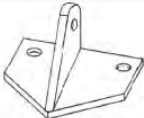
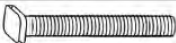

SUMMARY:

1. Remove the Roof Top Tent from the carton and place on a clean surface. Observe the top surface. It has four holes in the center area of the base, then this is the side which will receive the mounting channels. Otherwise you are looking at the surface which will receive the ladder. Open tent to gain entrance to interior and remove contents.
2. After removing the contents, close the Roof Top Tent, so the channel mounting surface is facing upward, then move the cap of holes (side with 4 holes).
3. Using four supplied 35mm Steel MB bolt into the mounting channels, insert it into the predrilled holes.
4. Place mounting channels on exposed bolts. For side mounted orientation, ensure the mounting channels are perpendicular to hinge side. For rear mounted orientation, ensure the mounting channels are parallel to hinge side.
5. Insert the M8 Nylock Nut with washer with 35mm steel MB bolt on the tent base. Tighten the MB Nylock Nut using the supplied 13mm wrench. Fasten mounting channels to base as described above. (Diagram A)



The mounting extrusion fitted to the base of the tent with the slide plate and bolt fitted.



PARTS CHART		
2 pc	Ladder mounting bracket	
8 pc	55 mm steel m8 bolt	
4 pc	35 mm steel m8 bolt	
2 pc	16 mm steel m6 bolt	
4 pc	40mm steel m6 bolt	
4 pc	Stainless Steel Mount Plate	
2 pc	Stainless Steel Washer	
6 pc	M6 Nylock Nut	
12 pc	M8 Nylock Nut	
12 pc	Stainless Steel Washer	
3 pc	10 x 13 mm Metric Wrench	
2 pc	Mounting Channel	

INSTRUCTION 1 PICTURE

1. Slide the 35mm M8 Bolts into the inner slot in the center of the mounting tracks until they are aligned with the holes in the mounting tracks and the base.



INSTRUCTION 3 PICTURE

3. Using the supplied 35mm bolts M8, add steel washer to each bolt. Slide your hand between base and mattress and hold nut in place. The bolts should pass through the holes in the tent base and the mounting tracks. Reach under the mattress and tighten the nuts firmly using the supplied ratcheting 13 mm wrench.

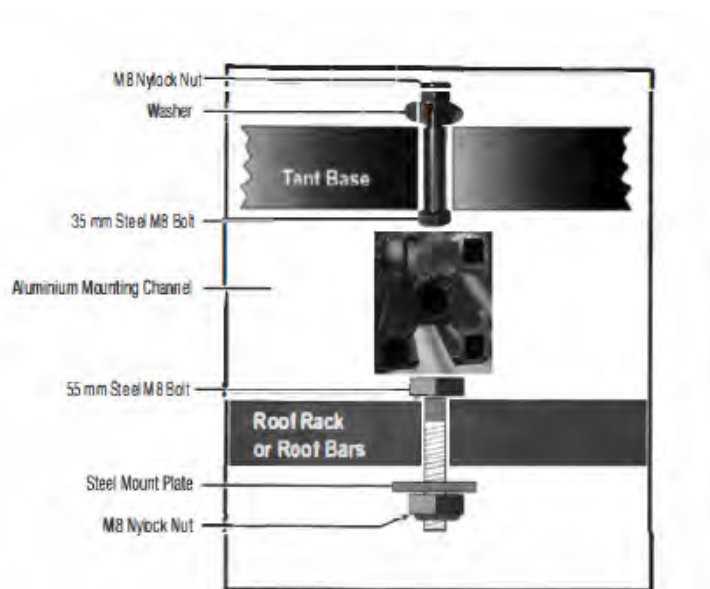

INSTRUCTION 7 PICTURE

4. Attach the brackets to the ladder by threading the 40 mm Steel M6 bolt through a steel washer, the lateral side of the ladder bracket, the rubber washer, and the hole in the ladder, followed by a nylock nut.

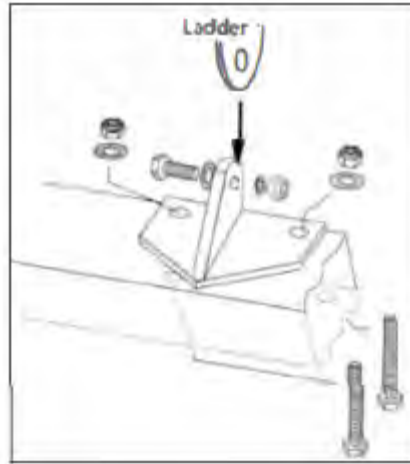

Driving Cover Attachment

1. To attach the travel cover, slide the rounded fabric end of the cover into the rounded C-channel at the hinge side of the tent base. Make sure the cover is oriented, so the exterior side of the cover faces up when you pull the cover over the tent



2. Fasten the Velcro straps on either side of the tent to hold the canopy in place



3. Zip the travel cover to the base along the other three edges, taking care that the tent fabric does not become caught in the zipper. Secure the two long Velcro straps over the top of the travel cover.

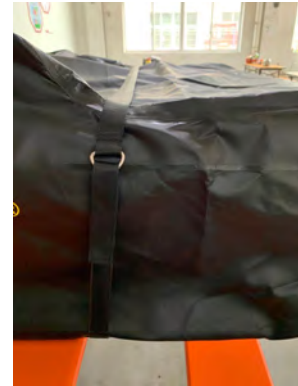

Final Step Attachment to The Roof Rack

1. This will take 2-3 people
2. Place the tent on top of your vehicle rack system, ensuring the mounting tracks are perpendicular to the bars they will mount to, and the tent is centered on the roof rack.
3. Position the hinge so that the tent will open to the desired side.
4. Slide the 8mm bolts and channel sliders into the mounting tracks. Lift one side of the tent to position one set of bolts and channel sliders on the inner side of the roof rack bar and an additional set on the opposite side. Repeat on all four corners.



3. At each of the four corners where the rack bars and mounting tracks cross, using a steel mounting plate and nylock nuts to secure the bolts on either side of the bar. Tighten all eight (8) bolts securely with the included nuts and wrench. Check all the mounting bolts and brackets before you leave for camping.

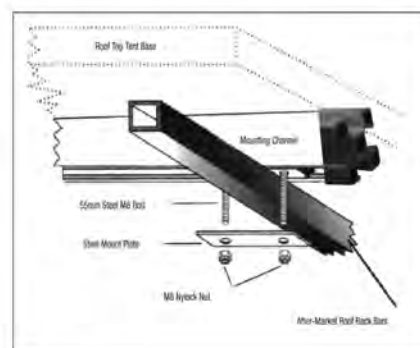
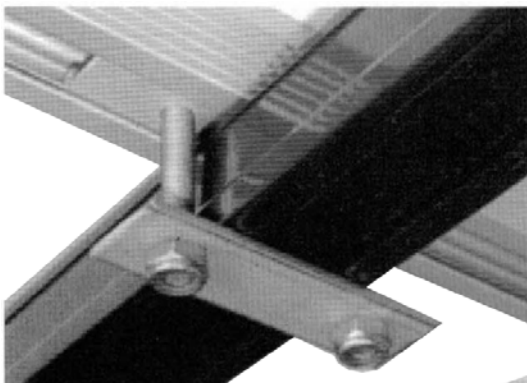

DIAGRAM D

4. After ensuring the tent is positioned correctly and centered and all eight bolts are tightened securely, insert the rubber end caps into the ends of the mounting tracks.



Note: You can lightly tap them in with a rubber mallet.

Tent Set Up

1. Release the straps over the travel cover. There will be two or four straps depending on model.
2. Unzip the travel cover. Most people do not remove it they let it hang off the side of your vehicle or roll up and tuck under the tent.
3. Unbuckle the straps on the sides of the tent and across the ladder.
4. Use the ladder as leverage to open the tent by pulling straight back until the ladder rests firmly on the ground. Assure all the steps on the telescoping ladder are locked. The tent base should be level and the ladder should form a 60° angle with the ground.
5. To adjust the ladder height, pull on the locking pins in front of ladder and adjust to the desired height. Make sure the pins lock at the desired height.
6. Unfasten the grommets on the awning and rainfly. Locate the fabric slits in the tent skirt. Pre-drilled holes are located underneath each slit. Insert the rainfly rod at a 45° angle into the hole and bend slightly to hook the other end through the grommet. Repeat this process for both holes in the awnings and both holes at either end of the rainfly.

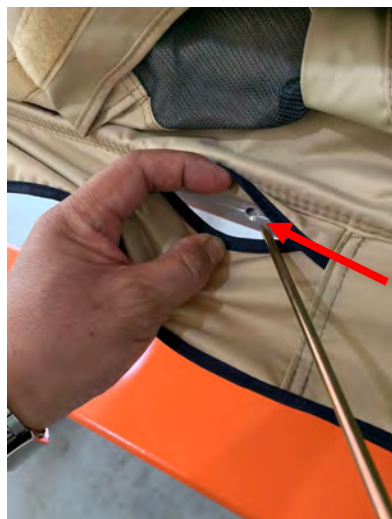

Rain fly Rod Installation



LADDER SETUP:

1. Slide the ladder out, starting at the base of the ladder until the locking pins in each section engage. Use ladder as a lever to open the tent.



2. Allow the ladder to rest firmly on the ground. The tent base should be level with the ground while the ladder sits firmly on the ground making an angle between 70 and 85 degrees with the ground.

3. Assure all the steps on the telescoping ladder are locked. If you need to adjust the height of the telescoping ladder, start with the top section and release the locking levers. Slide the ladder up so the top most section recedes fully into the section below it. Repeat this step for each section you wish to shorten the ladder by. Be sure to maintain an angle between 70 and 85 degrees between the ground and the ladder at all times and ensure that the remaining sections are fully locked if you adjust the ladder height as described above.



Storage and Handling

- 1) Do not pull down on side retaining velcro straps when closing the tent. These straps are designed only to hold the tent base together, and are not designed to be used to pull the bases together. When you are closing the tent, hold down the top folded base to compact the tent, then use the velcro straps to secure the bases in this position. These straps will tear out of the tent if excessive force is applied to the strap.
- 2) Open the tent fully and brush / vacuum inside.
- 3) Clean the fabric as needed using a mild detergent, warm water, and a soft to medium brush. Rinse fabric of all detergent prior to drying.
- 4) Dry tent in the sun with all windows open. The tent must be completely dry before storage, or mildew and mold may occur. This is especially necessary after camping in rain or wet conditions.
- 5) Using a small brush you can remove dirt from the zipper. You can use bees wax or a silicon spray to keep the zipper lubricated
- 6) Wash the mattress pad and hang dry only.
- 7) Always be aware that the addition of a roof top tent will increase the height of the vehicle. Knowing the height will allow you to safely enter garages and carports.
- 8) Before you leave always check the nuts and bolts attaching your rooftop tent to the rack. Make sure they are tight and secure. Check the locks and latches making sure the tent does not open while driving. Check the cover is sipped and strapped.

Limited Manufacturers Warranty

What is covered

Tuff Stuff Overland warrants to the original purchaser that its products are free from manufacturer defects in material and workmanship, for the term described, except as qualified below.

What is not covered

Tuff Stuff Overland is not be responsible for the natural breakdown of materials that occurs with extended use (e.g., Ultra Violet (UV) light damage on tents, extensive use of zippers), or defects caused by accident, abuse, alteration, animal attack, storm damage, misuse or improper care.

THERE ARE NO OTHER EXPRESS WARRANTIES BEYOND THE TERMS OF THIS LIMITED WARRANTY. IN NO EVENT SHALL Tuff Stuff Overland BE LIABLE FOR INCIDENTAL OR CONSEQUENTIAL DAMAGES. Some states do not allow the exclusion or limitation of incidental or consequential damages, so the above limitation or exclusion may not apply to you.

What Tuff Stuff Overland will do.

If after inspection we find that a product failed due to a manufacturing or material defect, we will repair or replace the product, at our option, without charge.

How to obtain warranty service

Return the product, freight prepaid, to Tuff Stuff Overland; or, contact Tuff Stuff Overland Customer Care Department for return authorization: toll free 866-220-0171. Warranty shipments without return authorization cannot be accepted and will be returned at the customers expense. Please provide the RA# on all products.

How state law relates to this warranty

This warranty gives you specific legal rights. You may have other rights that vary from state to state.

Warranty term

Limited 12 Month warranty applies to all tent components including base, aluminum poles, ladder, fabric and seams.

WHAT PEOPLE ARE SAYING ABOUT US

Rated 4.7 out of 5 based on 1,254 reviews on Trustpilot

The image shows a Trustpilot review carousel with four reviews, each with a 5-star rating. The reviews are as follows:

- Review 1:** 5 stars, 2 hours ago. Title: "I thought the service was very ...". Text: "I thought the service was very good, given this Caron's virus panic-demic, yes spelled...". Reviewer: Jerry McPherson.
- Review 2:** 5 stars, 2 days ago. Title: "Great customer service!". Text: "I ordered a bed rack and the very next day got a call that a tent I'd ordered elsewhe...". Reviewer: Jenny J - WA State.
- Review 3:** 5 stars, 2 days ago. Title: "Very happy!". Text: "Very happy with the customer service I have received!". Reviewer: Scott Wilde.
- Review 4:** 5 stars, 3 days ago. Title: "Great Skid Plate!". Text: "Product arrived the next day. Super thick and heavy. Im very happy with the skid plat...". Reviewer: JC.

CUSTOMER CARE

Email:

Support@tuffstuff4x4.com

Telephone:

1-866-220-0171 Monday - Friday 8:30 - 5:00pm California Time

Tuff Stuff USA Headquarters: 2205 South Wright St, Santa Ana California USA

WELCOME TO THE TRIBE



tuffstuffoverland



emmaterres17



trail_benders_overland



sabrinaskiles



tuffstuffoverland naui



tuffstuffoverland



tuffstuffoverland naui



trail_benders_overland



overland_az



emmaterres17



tuffstuffoverland



readyssetgordon