



Overlander Tent Install Instructions/ Manual





WWW.SMITYBILT.COM

Overlander Tent

Note: Actual pictures may vary from specific vehicle/ product.

Std. Parts list:	Qty
Window rod	8
Mounting extrusion	2
Ladder mounting bracket	2
Ladder	1
Slide plate	8
Base plate	4
M8x55 mm bolt	8
M8 flat washer	8
M8 Nylock nut	8
M6x40mm hex bolt	8
M6x18mm hex bolt	2
M6 flat washer	16
M6 Nylock nut	10
M6 plastic washer	4
Shoe Bag	1
Tent cover	1
LED strip	1
Power supply	1
Power Extension	1
USB extension	1
Interior bungee	4

XL Parts list:	Qty
Window rod	6
Mounting extrusion	2
Ladder mounting bracket	2
Ladder	1
Slide plate	8
Base plate	4
M8x55 mm bolt	8
M8 flat washer	8
M8 Nylock nut	8
M6x40mm hex bolt	10
M6x18mm hex bolt	2
M6 flat washer	18
M6 Nylock nut	12
M6 plastic washer	4
Shoe Bag	1
Tent cover	1
LED strip	1
Power supply	1
Power Extension	1
USB extension	1
Tie down rope	3
Stake	3
Interior bungee	4

The Smittybilt Overlander Tents are designed to mount easily on most roof rack systems or on an aftermarket rack/crossbar system. The Smittybilt Overlander Tent weights only 118 lbs/139lbs, so it can be mounted to most rack systems. Generally, most OE roof racks will have a capacity of 150-200 lbs while vehicle is in motion(dynamic rating). However, when the vehicle is parked and you are utilizing your Smittybilt Overlander Tent you are applying a static load which is easier to support and most rack systems can generally handle this static load with ease. **Always check with the manufacturer of your vehicle and your roof rack system to determine the applicable weight limitations as they vary from vehicle to vehicle.** Not all factory roof racks or aftermarket racks can adequately and safely accommodate a roof top tent. Rack not only has to have the proper weight capacity for downward loads, but it must properly support upward and shock loads.

If you need a roof rack system or more carrying capacity you may check with your local supplier for Smittybilt, Thule, Yakima, or a variety of aftermarket racks to suit your needs.

Check local and state laws regarding roof mounted load capacities. Many states have a limit of 165lbs while vehicle is in motion, and therefore most vehicle manufactures will built their roof racks to meet that limit. The Smittybilt Overlander Tent weighs only 118 lbs/139 lbs, so it can be mounted to most rack systems.

XL tents must be supported by a minimum of 3 cross bars to evenly distribute the load.

Read instruction manual entirely before assembling and installing this product.

Product may vary from image.



Overlander Tent

Periodically check torque of all hardware.

Remove tent cover then place tent with tent base with holes face up on a clean, protected surface. Slightly open up tent, open up entrance and remove all parts from the interior of the tent.

Attaching the Mounting Rails to the Smittybilt Rooftop Tent

Direction of Opening

Before you fit your new rooftop tent to your vehicle, you will need to decide whether you wish to have the rooftop tent open to the back or to the side of your vehicle.

A. "Off the Back"

For most larger size (SUV) vehicles opening "off the back" is preferable. The advantages of this orientation are:

- Leaves extra roof space for additional storage.
- With the tent open you will gain weather protection from the tent above you head when accessing the back of your vehicle.
- Tailgate or rear hatch can be accessed from inside the annex(optional)

The mounting extrusions may need to be cut off at both ends up prior to being fitted to the base of the rooftop tent. Use tent bottom as a template and trim mounting extrusions so they fit within the tent base. Trim at the red line.

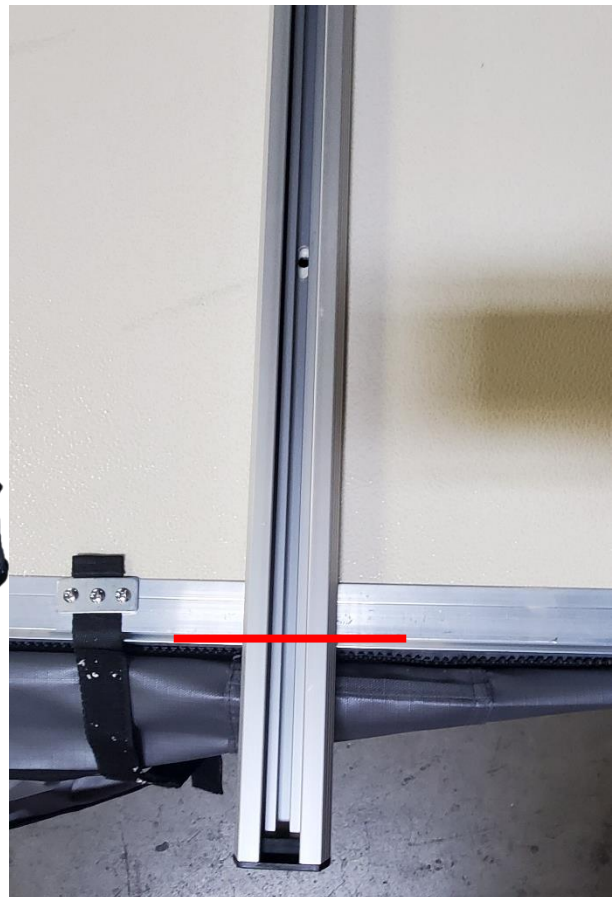



Overlander Tent

Periodically check torque of all hardware.

•“Off the Side”

For most medium (such as Jeep Wrangler) or small vehicles opening “off the side” is preferable. The advantages of this orientation are:

- Allows for tailgates to operate normally.
- Means the closed tent pack is better balanced on the roof and creates less wind drag as the narrow face of the tent pack is travelling forward.
- Allows the use of most hitch mounted accessories and trailers without detaching from vehicle.





Overlander Tent

Periodically check torque of all hardware.

Mounting Extrusion - Attachment Instructions

Step 1: Remove mounting extrusion from the carton (cut as per slide 3 if you intend opening the rooftop tent off the rear of your vehicle.)

Step 2: Place the tent on its side on the ground onto a clean surface.

Step 3: Using the supplied M6 bolts and washers, slide your hand in between the inside of the base and the mattress and insert the bolts into the pre-drilled holes.

Step 4: Place the mounting extrusion into position over the bolts.

Step 5: Slide the 6mm nuts into the mounting extrusions and tighten the bolts from inside the tent. Do not over tighten hardware. **NOTE:** as the tent base conforms and settles over time, you will be required to re-tighten the mounting hardware.

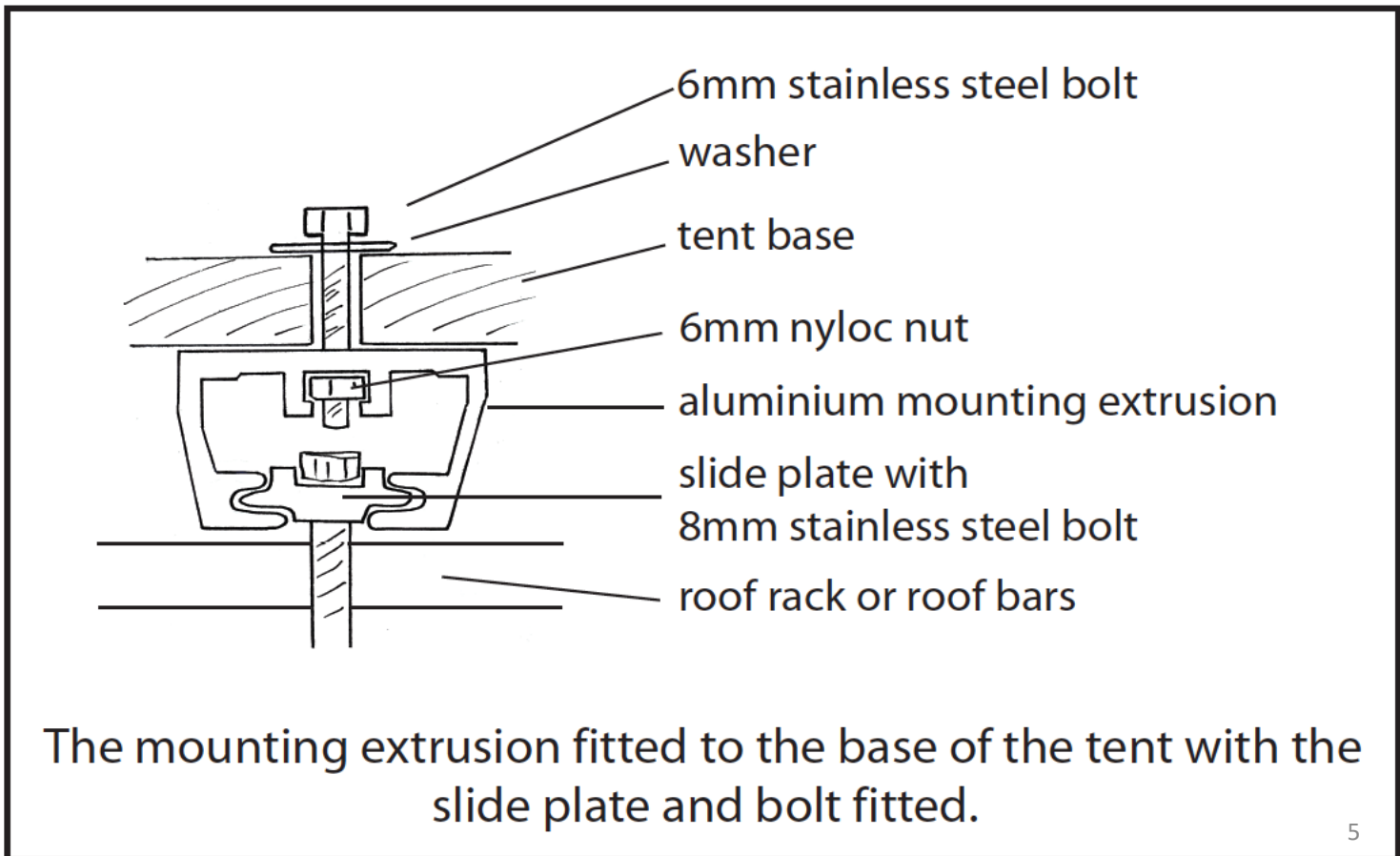

The mounting extrusion fitted to the base of the tent with the slide plate and bolt fitted.



Overlander Tent

Periodically check torque of all hardware.

Ladder - Attachment Instructions

Step 1: Mount the ladder brackets to the base of the tent using M6x40mm bolts. Bolt each ladder bracket to the base of the tent through the pre-drilled holes.

Step 2: Mount the Ladder brackets to the ladder using the supplied M6mm x 20mm bolts, washers, plastic washers, and nut. Plastic washers will go on both sides of the bracket on the ladder.

Note: Thread locker is highly recommended for these bolts as an extra measure for vibration resistance. Do not over tighten bolts, ladder must be able to rotate on ladder mount. Check movement, tighten hardware slightly, check movement and repeat till there is a slight resistance when rotating the ladder.



View from inside the tent



Ladder to ladder bracket attachment



Overlander Tent

Periodically check torque of all hardware.

Fitting the Rooftop Tent to your Roof Rack or Roof Bars

Step 1: With assistance, carefully lift the tent onto the vehicle.

Step 2: Place M8 bolt into the slide plate. Slide the plate and bolt into the mounting extrusion. Orient the bolts so one is on each side of the cross bars you are attaching to.

Step 3: Attach the rooftop tent to your roof rack or roof bars in four places. Use 2 M8 bolts and 2 slide plates with the base plate to hug the bar. 1 set per corner. XL tents do not need to be secured to the center cross bar as long as the mounting extrusions are supported by the center cross bar. Cross bars should be evenly spaced to support the tent base evenly. If cross bars are towards the extreme ends of the tent base, they will not adequately support the center of the tent and may damage tent.

Do not over tighten nuts as this will cause the bolt head to strip the aluminum slide plate.

Periodically check torque of all hardware.

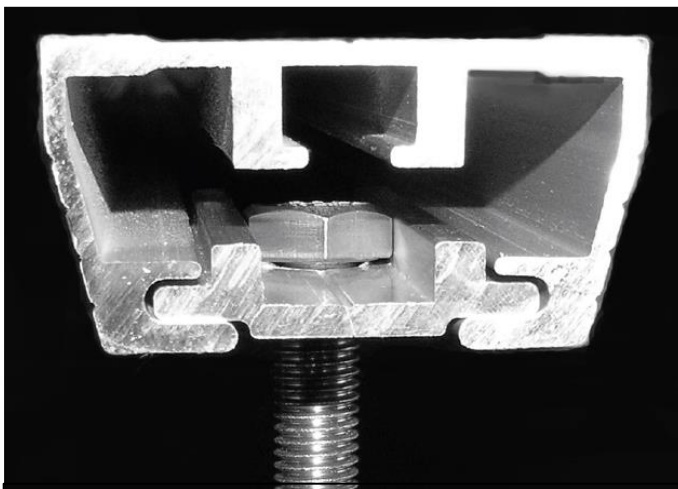

Inside view of mounting extrusion with slide plate and M8 hex bolt.



Base plate secured around crossbar on roof rack.



Overlander Tent

Periodically check torque of all hardware.

Set Up Instructions

Step 1: Unfasten the cover straps and then remove the cover from the tent.

Step 2: Release the hold down Velcro straps on all sides of the tent. Then double check that all are released.



Step 3: Pull out the ladder till it is fully extended.. The ladder can now be used as a lever to help open the tent. Carefully fold open tent. Rest the ladder on the ground. If the ladder is out at an extreme angle, it will need to be adjusted shorter. The ladder should be at a slight angle not to exceed 25° when properly adjusted. The ladder must be of adequate length to support the tent while open. Ensure the tongue and groove of the tent halves are engaged, if center is popped out of the groove, slightly close the tent and apply upward pressure to the center of the tent base near the tongue and groove while opening the tent fully. Once weight is put on the tent, it will help with a strong engagement of the tongue and groove.

See next pages for ladder adjustment and tent opening.

Step 4: Remove the internal bungee straps, save for repacking of the tent. (these straps run left to right and attach to the loops inside the tent. They help pull the fabric inward when closing the tent.



Overlander Tent

Periodically check torque of all hardware.



Fully extend ladder. Excessive force will damage tent base/floor.



Use ladder as leverage to open tent by pushing down slightly while pulling straight back.



Carefully guide ladder to the ground.



**SUPPORTS
CAMPING
& SPORT
ACCESSORIES**



Gen 1 Ladder Adjustment

Periodically check torque of all hardware.

Gen 1 sliding ladder features several adjustment holes for ladder height adjustment. You may drill additional holes if you need to fine tune or shorten the length of the ladder. Do not drill any adjustment holes below the bottom factory pre-drilled hole as damage will occur. Use a 3/8" drill bit to drill new adjustment holes.

If ladder needs to be longer, Ladder extension #2785 is available separately and will add 12" per extension.



Ladder extension part#2785

Gen 1 Ladder Adjustment

Periodically check torque of all hardware.

Spring loaded locking position



Ladder knobs can be pulled up and twisted $\frac{1}{4}$ turn to lock them in the open position. Turn another $\frac{1}{4}$ turn to allow them to go back into the spring loaded locking position.

Unlocked raised position

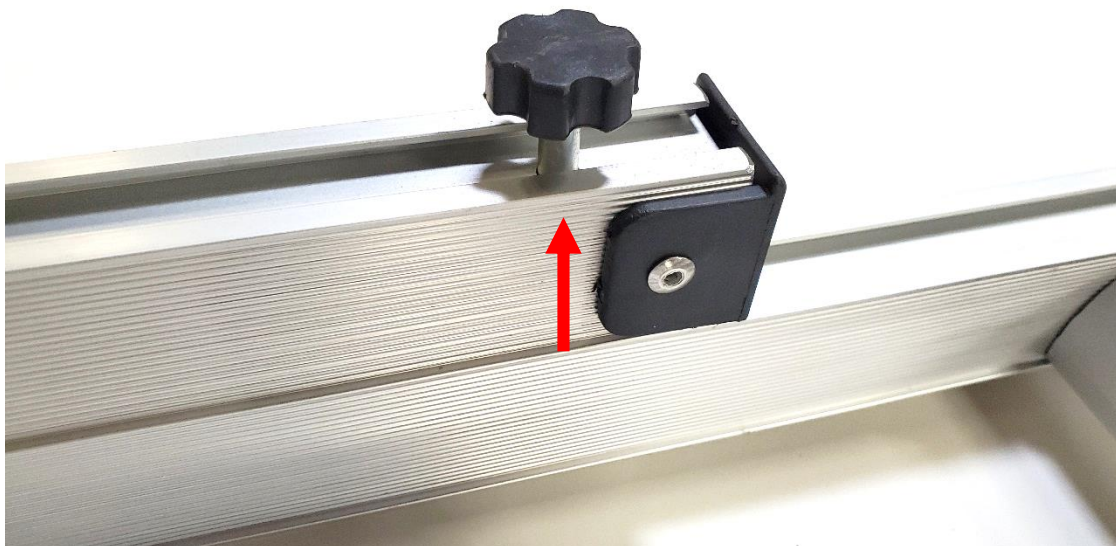



**Gen 2 Ladder Adjustment
Part# 2583&2683**

**Periodically check torque
of all hardware.**

Ladder Adjustment Instructions

For the most adjustment, press in the top most steps buttons and then collapse ladder. If more or less adjustment is needed. The second thru the eighth step can be adjusted in smaller increments. Depress the ladder buttons and collapse the ladder slightly, then release buttons and compress ladder till it stops in the half adjustment position. Ensure that all sections of the ladder are fully locked before use. Ladder should be solid when putting downward pressure on it.

Ensure ladder is level on a flat, non-slip solid surface. Tie down ladder to vehicle if needed to prevent movement.

Ladder is required to be in a locked position to support half of the tent. Failure to properly adjust will cause damage to the tent, ladder, or mounting system.



Second from the top rung shown in the half way locked position.



Top rung fully collapsed, second from the top half way collapsed in the locked position.

Periodically check torque of all hardware.

Floor latch

Step 1: Open tent fully. Locate hinge latch in the center of the tent on the main hinge. Then swing latch arm over the latch post. You may have to pull down on the tent floor to get latch arm and post to line up correctly. Fig 10-12.

Step 2: Release floor latch before folding tent into the closed position.

Note: Periodically lube latch with BreakFree CLP.

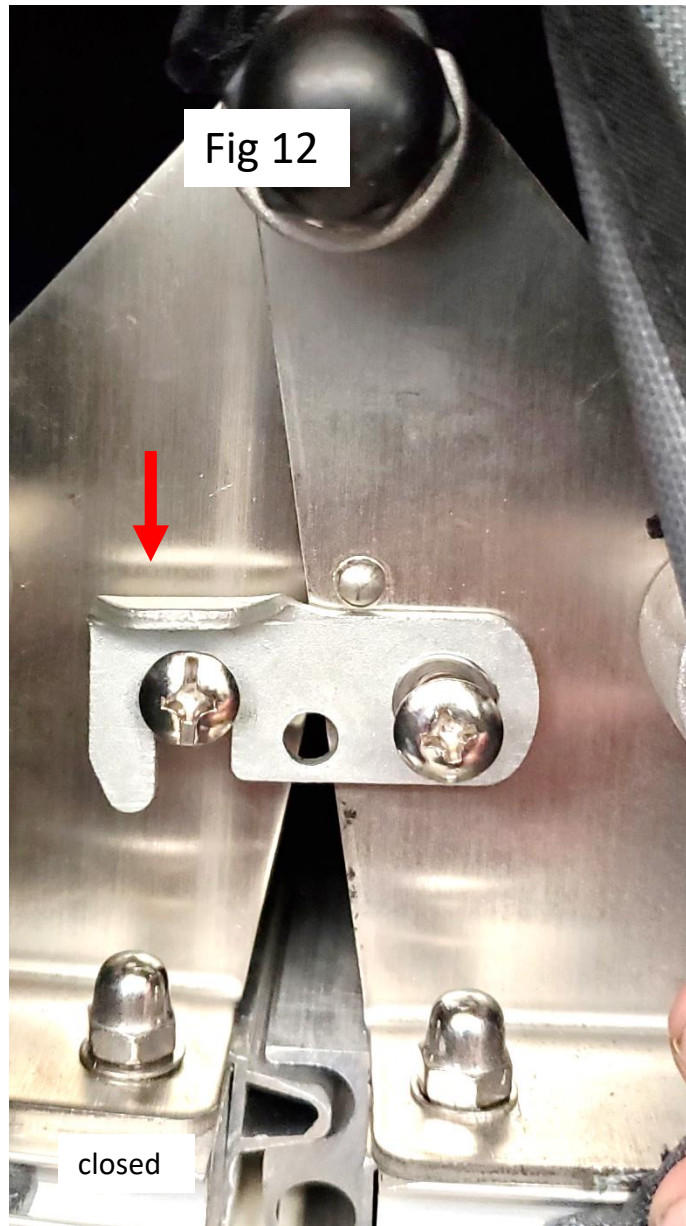
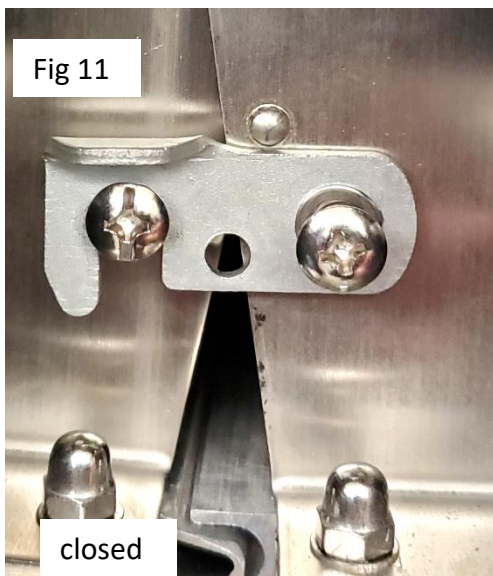



Overlander Tent

Periodically check torque of all hardware.

Window/door Rod Install

Step 1: Line up the slot on the base of the tent with the predrilled hole. Slide base of rod through slot and into base of tent, make sure rod is installed completely.

Note: They are meant to have a “bow” in them when installed. They will be at an angle to the side when installed into the holes.

Step 2: Place the hook end of rod through grommet on rain fly/shade cover with the hook part facing outward and downward.



Note: Side flaps/windows may be strapped down by pulling the bottom toggle through the eyelet on the flap/window. (Depending on model)





Veranda Support XL models

**Periodically check torque
of all hardware.**

NOTE: Carefully read entire instructions thoroughly before attempting to install this part. Photos are for illustration purposes and actual product may vary. Install remains the same

Step 1: Assemble main veranda pole. Short poles will slide onto the main hoop and secure with push pins. Make sure pins line up with the holes in the poles and are completely engaged. Fig 1&2.



Step 2: Position main assembly into the corners of the veranda. Once in position, install the ends of the main assembly into the retaining socket on the inside corner of the tent. Make sure you do not catch the tent fabric inside the tube. DO NOT install assembly into the socket and then try to pull veranda over assembly, damage will occur. Always position assembly inside the fabric and then install into sockets. Fig 3&4.



WWW.SMITTYBILT.COM

Veranda Support XL models

Periodically check torque
of all hardware.

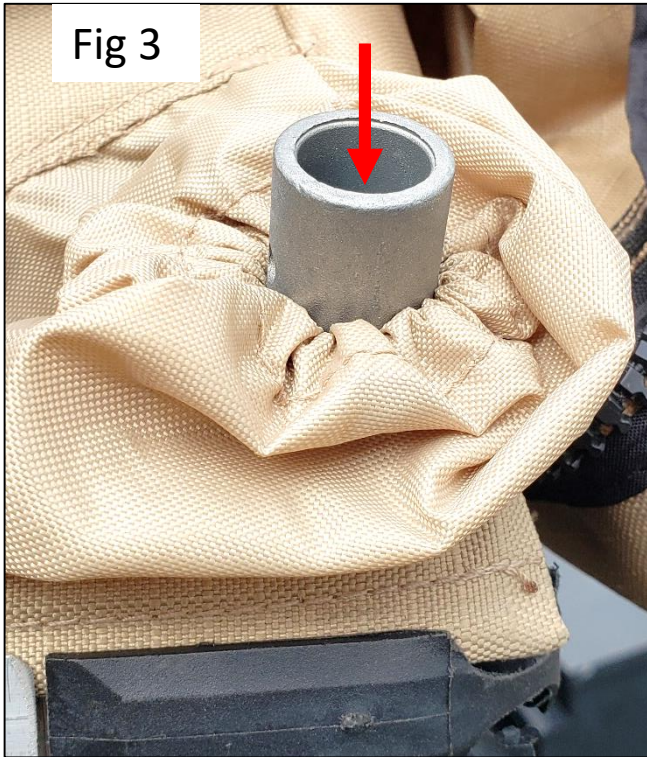

Fig 3



Fig 4

Step 3: Install the 3 short support tubes. First push the tube thru the sleeve openings in the tent body. Then clip onto the interior pole. Clip other end to main veranda pole assembly. Do one pole at a time. Fig 5&6. Once all 3 short poles are in place, install the long pole to the outer short poles in the middle of the veranda. Fig 7 &8.



Fig 5

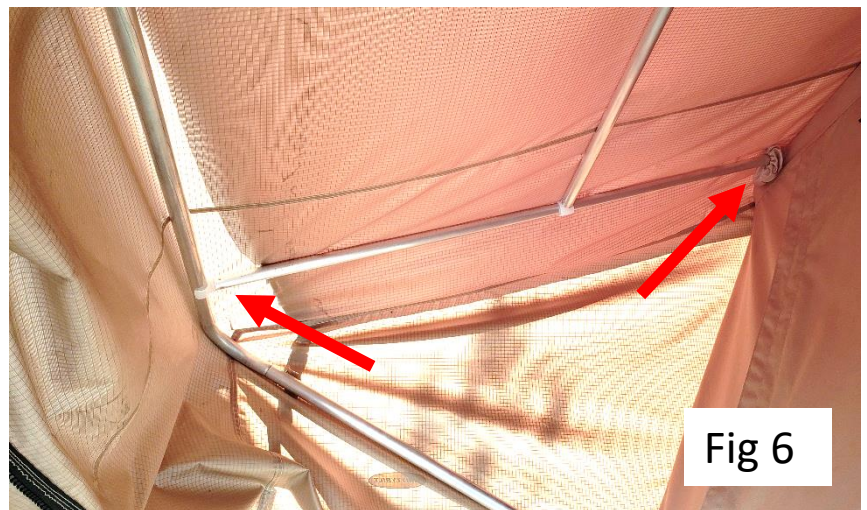

Fig 6



Veranda Support XL models

Periodically check torque
of all hardware.

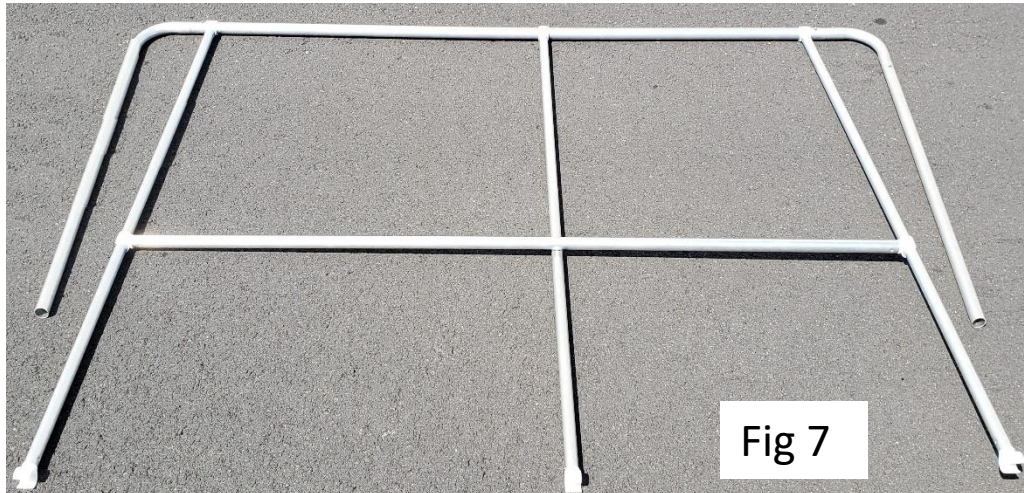

Fig 7 shows the
orientation of the
support poles and
main hoop without
tent skin.



Step 4: Attach guy ropes to veranda and secure with stakes. Fig 9 & 10.



WWW.SMITYBILT.COM

Veranda Support
XL models

Periodically check torque
of all hardware.



Fig 9



Fig 10



XL Gen 2 Tent

Periodically check torque of all hardware.

XL Gen 2 features easy opening main door. Allows the solid door to be opened and closed without having to open the mesh door. The main zipper will close the mesh door. The interior zipper will close the solid door.





XL Gen 2 Veranda

Periodically check torque of all hardware.

Veranda features three tie down points which are needed to properly tension the veranda. Use guy ropes and stakes at all three locations. Ensure guy ropes are tensioned tight enough to prevent movement of veranda. Tie guy ropes to the loops on the veranda and secure with stakes.





XL Gen 2 Tent Rain Fly

Periodically check torque of all hardware.

Gen 2 Rain Fly has multiple tie down points. All tie down points must be used and properly adjusted when rain fly is in use. Five per side plus 3 at the veranda end on XL models.

Adjust the straps so rain fly is evenly tensioned around the entire tent. The 3 center ones above the middle do not need to be very tight, only enough to hold the rain fly and rain fly poles down.





Overlander Tent

Periodically check torque of all hardware.

Storage and Handling Guidelines

Cautions

- **Do not pull down on side retaining Velcro straps when closing the tent.** These straps are designed only to hold the tent base together, and are not designed to be used to pull the bases together. When you are closing the tent, hold down the top folded base to compact the tent, then use the velcro straps to secure the bases in this position. These straps will tear out of the tent if excessive force is applied to the strap.
- **Do not store the tent wet.** If you do have to pack away when the tent is wet, zip closed all canvas doors and windows to protect the inside of the tent, and pack away. As soon as you can, open the tent and let it dry out thoroughly to prevent mold and rot. If the tent is to be closed up for extended periods of time it is very important that the tent is completely dry.
- **Be aware that with a rooftop tent fitted to your vehicle the overall height is increased.** You should measure the overall height of your vehicle with the rooftop tent fitted as you will need this information to decide if the vehicle can enter carparks etc.
- **Centre of gravity.** The attachment of a rooftop tent to your vehicle (similar to any other load on your roof rack) will alter its center of gravity. Adjust your driving accordingly.
- **Pre/ In trip inspections.** Regularly check that all nuts and bolts attaching your rooftop tent to the roof of your vehicle are tight and in good repair. Check all tent hardware, such as mounting extrusion hardware, hinge attachment hardware, ladder mounting hardware, EVERY nut and bolt. It is your responsibility for this maintenance. Improper or lack of maintenance will void tent warranty.
- **Please note:** The roof top tent is not made for extreme conditions, and a fair use policy is required. Excessive rain, wind, snow, and other extreme conditions can affect and/or damage the tent.

Storage of the Tent

1. If storing the tent off the vehicle, ensure the tent is packed away completely dry.
2. Be careful not to drag the tent on the ground. This will damage the cover and allow potential water ingress the next time you use your rooftop tent.
3. Do not store directly on concrete floor.
4. Do not place items on top of the tent as damage can occur.
5. If possible, keep tent elevated off the ground.



Care Instructions

1. Clean only with cold water and a soft brush - do not use soap or detergent, this will remove the waterproofing compounds.
2. Do not expose to petrol, oil or solvents.
3. New poly/cotton fabric will initially experience some weeping through the seams. This will reduce over time as the fabric cures.
4. Well worn products may be re-proofed using a good quality waterproofing solution. This is highly recommended. Generally this is re-applied every 1-2 years depending on how much you use or clean the tent and what environments your tent has been used in. Some waterproofing agents may also contain UV inhibitors. 303 protectant fabric guard, Star Brite, Rain guard, Nikwax and Kiwi all offer polycotton safe waterproofing solutions.
5. It is recommended to season your tent before your first trip. You can season the tent fabric by setting up tent on a level surface before actual use. Do a full set up, use all window rods. Make sure all windows and zippers are completely closed. Do not have the rain fly installed and remove all internal contents. With a hose, wet down the tent lightly. Then focus on all the areas that have been stitched and water log the fabric the best you can. Let tent dry completely on its own, do not use heat or compressed air to dry tent, let it dry naturally, avoid direct sunlight, this may take a day or so. Repeat this process two more times if necessary. This process allows the canvas and threads to shrink and expand as much as they can effectively sealing the seams. Do not be alarmed if the tent leaks for the first or second time you season the canvas as this is normal as the thread and canvas contract and expand together. Liquid seam sealer can be applied after the 3rd seasoning. Season the rain fly by hanging it up and spraying both sides of the fabric with water in the same procedure as the tent.
6. Zippers can be lubed with a silicon spray or bee's wax, this keeps them lubed and helps with water resistance. Clean zippers with a soft brush.
7. If the fabric needs cleaning, use a mild detergent mixture(1 cup Lysol all-purpose cleaner to 1 gallon of warm water) use with a soft brush to clean fabric as needed. Rinse off the tent with a rinse solution of (1 cup lemon juice, 1 cup sea salt to 1 gallon of warm water). Final rinse with cool water. Allow to dry completely before storage. Re-proof tent if needed.
8. Stainless hardware will stain less than zinc coated hardware but it still needs routine maintenance. After you check torque on bolts, wipe down with a cloth and break-free clp.



Overlander Tent

Limited Warranties

Smittybilt's products are covered under various limited warranties only. Note that the duration of the limited warranty differs according to the material and finish of the product purchased. Overland tents carry a 1 year warranty from date of purchase. Subject to the duration and conditions of the limited warranty stated below, Smittybilt warrants to the original retail purchaser that its products are free from defects in material and workmanship. Smittybilt shall not be responsible for the natural wear and breakdown of materials that occurs with extended use, such as UV damage or worn zippers, abuse, misuse, storm damage, or improper care. All other warranties and representations express or implied, are hereby disclaimed, including fitness for merchantability and buyer's intended use or purpose. All parts are sold "AS IS" except for the limited warranties granted herein. Buyer assumes all risks as to the selection, suitability and performance of all goods and products selected. This limited warranty does not cover damage or impairment in any part due to misuse, improper installation, accident or contact with on-road or off-road hazards, product modification, improper or inadequate cleaning and/or maintenance. Smittybilt is not responsible for items damaged during shipping. This warranty is not transferable from the original buyer. For the original Buyer to be eligible for the limited warranty coverage, the Buyer must provide proof of purchase. Smittybilt strongly recommends returning the warranty registration card.

Customer's remedy hereunder shall be limited only to repair or replacement (at Smittybilt's option) of any defective part(s) returned to Smittybilt at customer's expense. The determination of whether or not a returned part is defective or subject to coverage under the limited warranties stated herein shall be made at Smittybilt's sole discretion. Any returns must be made freight pre-paid by consumer.

To assure product quality, Smittybilt reserves the right to change product design, material, specification and finishes without prior notice to customers. This limited warranty gives you specific legal rights and you may also have other rights, which may vary from state to state. Some states do not allow limitations on how long an implied warranty lasts, so the above limitations may not apply as to you. Also, some states do not allow the exclusion or limitation of incidental or consequential damages, so the above limitations or exclusions may not apply to you. Smittybilt reserves the right to discontinue product lines and substitute products, or provide other remedies than those listed in this limited warranty for those discontinued products.

Warning

Rollover and other types of vehicle accidents may result in serious injury or death to you, your passengers and others sharing the road. Smittybilt accessories are decorative and are not intended to reduce or avoid injury or damage in the event of an accident. The weight and location of Smittybilt accessories may affect your vehicles' handling, stability and performance, creating an increased risk of accident or rollover. Before installing any accessory, check state laws and assure that the accessory will not obscure any lights or interfere with proper operation on your vehicle's safety equipment. Consult your owner's manual and the Smittybilt instructions, or additional safety information. Smittybilt products, nor the warnings contained herein, are not a substitute for your safe driving. Don't drink and drive, always use seat belts and don't drive faster than conditions permit.