

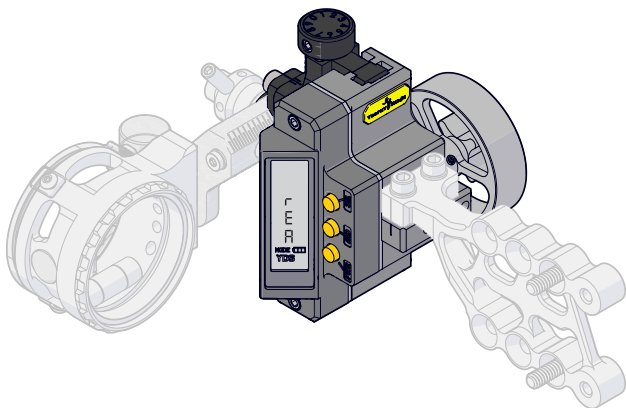

DIGITAL REACT SIGHT MANUAL



2200 Stringtown Rd.
Evansville, IN 47711
800 - 694 - 9494 • fax 812 - 467 - 1245
www.TrophyRidge.com



Visit our youtube
page to find videos
on how to set up.

CONTENTS

Contact Information	_____	1
General Instructions	_____	3
SET UP - Yardage	_____	4
SET UP - Speed	_____	5
Adjusting for Accuracy	_____	6
Settings- Change Precision	_____	7
Settings- Change Colors	_____	8
Settings- Brightness	_____	9
Settings- Units of measure	_____	9
Settings- Orientation & Profiles	_____	10
Warnings	_____	11
Warranty	_____	12
Contact Information	_____	13

GENERAL INSTRUCTIONS

The First step in using your Digital react sight is to charge it for at least 8 hours to have a full charge on the new battery. Use the charger and cable provided with the sight or use a compatible 5.0 V 1.0 A charger. If you charge the sight in your car or with your computer, it will take approximately 48 hours. The battery fully charged will last approximately 48 hours if left on. The back light will go off after 10 seconds to conserve energy. This helps the sight conserve power.

The battery indicator light has 3 bars. The battery at low power will show no bars and will flash. There will be about 2 hours of battery life at this point.

Once your sight is sighted in and on it will go into power save mode while on and can be turned back on by turning the yardage knob and the screen will indicate the yardage location of the pin.

NOTE

When you plug in the sight you can see the battery indicator by pushing the power button (PWR), you will be able to verify your sight is charging. The battery indicator will blink. The sight does charge while off. See Detail A.

NOTE

To avoid damage to the battery, the sight has a battery threshold setting. The screen will go blank, but the sight can be reactivated by turning the main adjustment wheel or any button on the sight. The screen will come on for 20 seconds and go blank. This can be repeated up to 10 times. Your sight must be charged. This will ensure a healthy battery life.

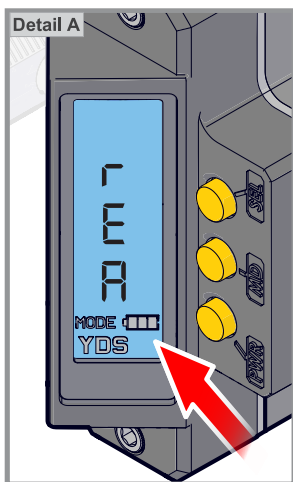

IMPORTANT – When you have finally sighted in your sight for your bow, be sure to add the sight tape with the appropriate markings. If you forget to charge your sight you will be able to use the sight tape markings.

Note - The screen turns blue when you have chosen a certain mode or item. This is an indicator that you can now make changes to that certain mode or item.

There are 2 methods of setting up your sight. The first method is the yardage method inputting 1st and 2nd pin distances. The second method is the speed method entering the 1st pin distance and then the bow speed.

SET UP - YARDAGE

TROPHY RIDGE® DIGITAL REACT SIGHT

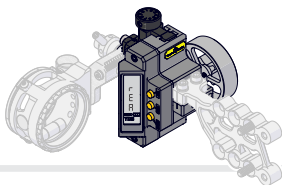

NOTE

For best results before using the sight charge the battery for 8 hours. Leave sight off while charging.

With main adjustment wheel, roll sight to top position. Sight in your pin using the tool-less micro adjust windage and elevation knobs at 20 yards.



PWR = Power on/off button
MD = Mode button
SEL = Select button

BEGIN

- Power on – press power (PWR) once and the screen will flash, sight is powering up.
- Once powered on you will see a number or you will see rEA.
- If you see rEA then press select (SEL). See [Detail A](#).

NOTE

If you see a number press and hold mode (MD) button until you see rEA. If at anytime you wish to start over, press and hold the MD button until you see rEA for React mode.

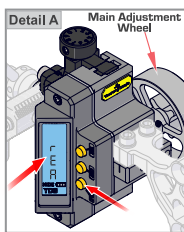

- Screen will show 1ST. See [Detail B](#).
- Press SEL.
- 20 will flash on a blue screen indicating the 20 yard setting. See [Detail C](#).

NOTE

If you do not select within 10 seconds the back light will go off and the number will no longer be flashing. The sight is still awaiting input.

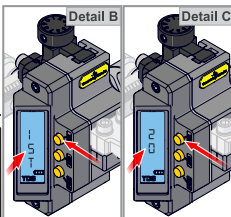

- Press and hold SEL. You will see 1ST. Now you have set your 20 yard pin location.
- Once 1ST distance is set, move to 30 yards.
- Press MD until you see 2ND. See [Detail D](#).
- Press SEL. The screen will then turn purple and display the current distance. See [Detail E](#).
- Turn Main Adjustment wheel to 30 yards showing on the screen.
- At the 30 yard distance shoot your bow. Adjust your sight using the main dial until you are on target at 30 yards. The screen may show a different distance.

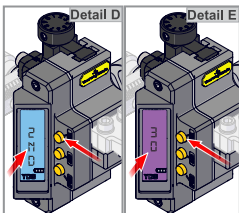

NOTE

Make sure that your pin adjustment is accurately 30 yards. Even if the number on the screen is higher or lower than 30.

- Once your bow is sighted in at 30 yards, press and hold SEL for 2 flashes, release and the screen will turn blue. See [Detail F](#).
- Press SEL to increase the number or MD to decrease the number to adjust the sight reading to 30 yards.
- Press and hold SEL for 2 flashes and the screen will turn grey. See [Detail G](#).
- Your sight is now calibrated for all distances and is ready to use.

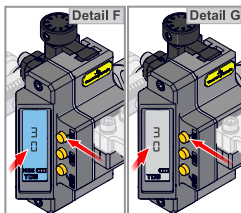

NOTE

If you do not select it within 10 seconds. After 10 seconds it will be a solid number and not color.

Press SEL to increase the number and press MD to decrease the number. Continue to press SEL or MD until you get to the number 20 yards. Stop pressing SEL or MD and then press and hold SEL. The number will flash x2 and you can release the SEL button.

You will then see 1ST. 1ST pin is now set.

If you accidentally change the number from 20 or another number do the following.

Continue to press SEL or MD until you get to the number you need. Stop pressing SEL or MD and then press and hold SEL.

SET UP - SPEED

TROPHY RIDGE DIGITAL REACT SIGHT

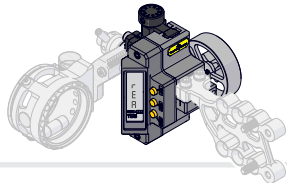

NOTE

Before you begin For best results, be sure to verify your bow and arrow speed by shooting through a calibrated chronograph.

With main adjustment wheel, roll sight to top position. Sight in your pin using the tool-less micro adjust windage and elevation knobs at 20 yards.



PWR = Power on/off button
MD = Mode button
SEL = Select button

BEGIN

- Power on – press power (PWR) once and the screen will flash, sight is powering up.
- Once powered on you will see a number or you will see rEA.
- If you see rEA then press select (SEL). See [Detail A](#).

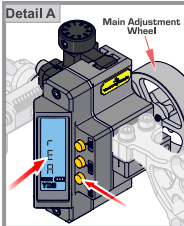

NOTE

If you see a number press and hold mode (MD) button until you see rEA. If at anytime you wish to start over, press and hold the MD button until you see rEA for React mode.

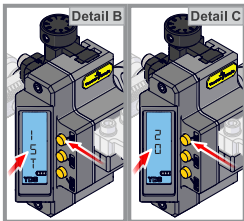

- Press SEL.
- Screen will show 1ST. See [Detail B](#).
- Press SEL.
- 20 will flash on a blue screen indicating the 20 yard setting. See [Detail C](#).

NOTE

If you do not select within 10 seconds the back light will go off and the number will no longer be flashing. The sight is still awaiting input.

- Press and hold SEL. You will see 1ST. now you have set your 20 yard pin location.

- Once 1ST distance is set, you can now enter your bow and arrow speed, that was measured on the chronograph.
- Press MD until you see SPD. See [Detail D](#).
- Press SEL. The number will be in blue and represents the speed of your bow in FPS. See [Detail E](#).
- Adjust the FPS with SEL to increase and MD to decrease the number until you see the correct speed.

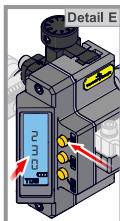
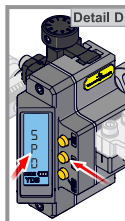

- Press and hold SEL for 2 flashes, the screen will turn grey. See [Detail F](#).
- Your sight is now calibrated for all distances and is ready to use.

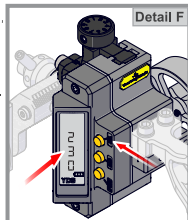

NOTE

If you do not select it within 10 seconds.

After 10 seconds it will be a solid number and not color.

Press SEL to increase the number and press MD to decrease the number. Continue to press SEL or MD until you get to the number 20 yards. Stop pressing SEL or MD and then press and hold SEL. The number will flash x2 and you can release the SEL button.

You will then see 1ST. 1ST pin is now set.

If you accidentally change the number from 20 or another number do the following.

Continue to press SEL or MD until you get to the number you need. Stop pressing SEL or MD and then press and hold SEL.

NOTE

For improved accuracy at longer distances, additional yardage adjustments may be needed. Please see the adjusting for accuracy section.

NOTE

This device complies with part 15 of the FCC Rules. Operation is subject to the following two conditions: (1) This device may not cause harmful interference, and (2) this device must accept any interference received, including interference that may cause undesired operation.

ADJUSTING FOR ACCURACY - YARDAGE SETUP ADJUSTMENTS

If you are shooting at 50 yards and your sight is requiring a higher dialed in number to be accurate, for example 54.

- Leave your sight wheel at the 54 yard position. Do not move it.
- While standing at the 50 yard distance. Press and hold MD until the sight turns blue, rEA will appear on the screen. See [Detail A](#).
- Press Select (SEL), 1St will appear on the screen. See [Detail B](#).
- Press MD for the 2nd pin location.
- Press and hold SEL and select the 2nd pin location. The screen will turn blue. See [Detail C](#).
- Using the MD and SEL buttons adjust this distance to 50. Press and hold SEL to choose this distance. The screen will flash, release SEL. See [Detail D](#).
- PRESS and Hold MD to return to rEA. See [Detail E](#).
- PRESS and Hold MD to Return to Active mode
- Shoot a few arrows to confirm accuracy is at 50 yards and other yards above and below 50 yards

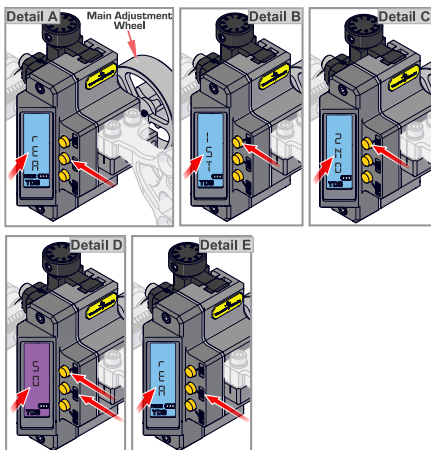

ADJUSTING FOR ACCURACY - SPEED SETUP ADJUSTMENTS

If you are shooting at 50 yards and your sight is requiring a higher dialed in number to be accurate, for example 54.

- While standing at the 50 yard distance. Press and hold MD until the sight turns blue, rEA will appear on the screen. See [Detail A](#).
- Press Select (SEL), 1St will appear on the screen. See [Detail B](#).
- Press MD 2 times to see SPd on the screen. See [Detail C](#).
- Press Select (SEL) for Speed settings.
- The bow speed will now flash on the screen.
- Using the MD and SEL buttons adjust the speed of your bow. See [Detail D](#).

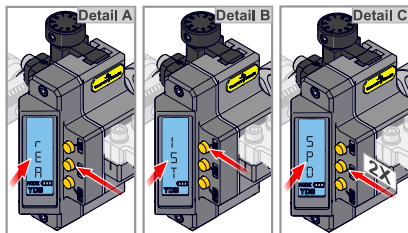

NOTE

If your bow is shooting **HIGH** increase your bow speed.
If your bow is shooting **LOW** decrease your bow speed.

- Press and hold SEL once you have adjusted your speed slightly. The screen will flash, release SEL.
- Press MD 2 times to see SPd on the screen. [Detail E](#).
- Press Select (SEL) for Speed settings. See [Detail F](#).
- The bow speed will now flash on the screen.

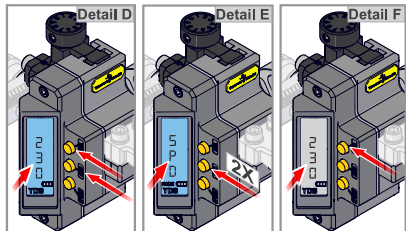

SETTINGS - ADDITIONAL FEATURES

The sight has several settings that can be adjusted. And is found under settings (SEt). To adjust the settings, follow these instructions to get into the settings mode(SEt). PRESS AND HOLD mode(MD), rEA will appear; press mode(MD) a second time and Settings (SEt) will appear in blue. Press the select button(SEL) to choose settings(SEt). The different settings that can be adjusted are whole or half yard increments(Prc), Back light color(cLr), Brightness settings(brg), unit of measure(unt) yards or meters, or additional profiles(Pro). Each of these can be found while quickly pushing the mode (MD) button after selecting settings. If you wish to exit settings press and hold the mode button(MD) for 2 seconds and the screen will flash. You can release the mode button(MD) and you will be back to the settings Menu(SEt). Press the mode button again(MD) and you will be at the rEA or react setting menu. Press and hold Mode(MD) for 2 seconds the screen will begin to flash, release the mode button (MD), and you will then be back in operation mode.

SETTINGS - CHANGE PRECISION (Prc)

BEGIN

- Power on – press power (PWR) once and the screen will flash, sight is powering up. Once powered on you will see a number or you will see rEA.

NOTE

If at anytime you wish to start over press and hold the MD button until you see see rEA or SEt

- If you see rEA press MD, you will then see SEt, if you see a number, press and hold MD until it flashes. Then you will see rEA, press MD to get SEt. See [Detail B](#).
- Press SEL.
- Prc on screen. See [Detail C](#).
- Press SEL.
- 1 on screen. See [Detail D](#).
- Press MD to toggle between 1 and .5. See [Detail E](#).
- With 1 or 0.5 on the screen press and hold SEL to select the yardage precision you require. The Number will stop flashing and return to Prc.
- With Prc on the screen press and hold MD to return to SEt. Press and hold again to return to active mode, with the numbers on the screen

Detail A

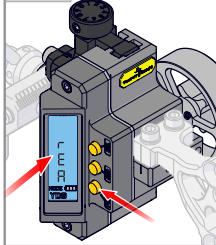

Detail B

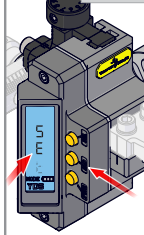

Detail C

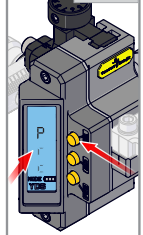

Detail D

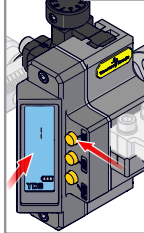

Detail E

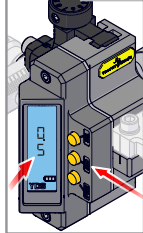

Detail G

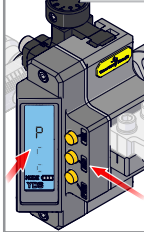

Detail F

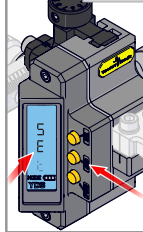

SETTINGS - CHANGE COLOR (cLr)

BEGIN

- Power on – press power (PWR) once and the screen will flash, sight is powering up.

- Once powered on you will see a number or you will see rEA.

NOTE

If at anytime you wish to start over press and hold the MD button until you see see rEA or SET.

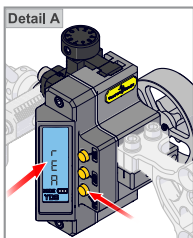

- If you see rEA press MD, you will then see SET, if you see a number, press and hold MD until it flashes. Then you will see rEA, press MD to get SET. See [Detail B](#).

- Press SEL.

- Prc on screen. See [Detail C](#).

- When Prc is on screen press MD once to go to cLr (colors).

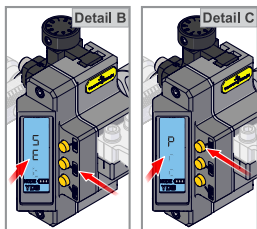

-When SET is on screen press SEL. See [Detail D](#).

-When Prc is on screen press MD once to go to cLr (colors). See [Detail E](#).

-When cLr is on screen press SEL. See [Detail F](#).

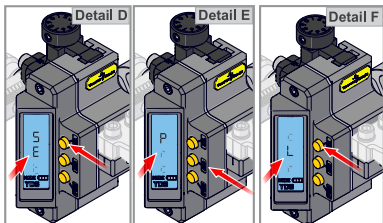

-Press MD or SEL to toggle through 6 colors and to off.

-With the color you would like as a background on the screen press and hold SEL to select the color of your choice. The color name will stop flashing and return to cLr. You have now chosen your back light color.

-The setting screen will remain blue until you return to numbers or active mode.

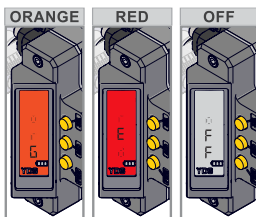
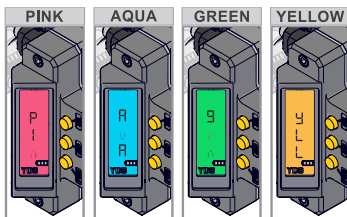

-Press and hold MD cLr will flash release MD and it will return to SET.

-Press and hold MD SET will flash release MD and it will return to the numbers and active mode.

SETTINGS - SCREEN BRIGHTNESS (brg)

-If you see rEA press MD, you will then see SEt, if you see a number, press and hold MD until it flashes. Then you will see rEA, press MD to get SEt.

-With SEt on the screen press SEL, Prc will now be on the screen. See [Detail A.](#)

-With Prc on the screen, press MD twice to go to brightness brg. See [Detail B.](#)

-With brg on the screen press SEL. See [Detail C.](#)

-Use MD and SEL to toggle between the 4 levels of brightness. 3,2,1, 0. 0 = brightness off. See [Detail D.](#)

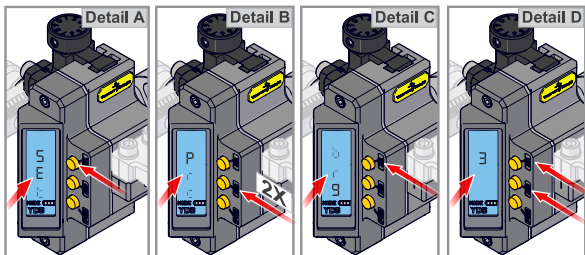

-With the brightness level number on the screen 3,2,1, or 0 press and hold SEL for the desired brightness

- The numbers will stop flashing, release SEL and return to brg.
You have selected your brightness.

- Press and hold MD, brg will flash release MD, SEt will appear.

- Press and hold MD SET will flash, release MD and it will return to the numbers and active mode

SETTINGS - UNITS OF MEASURE (unt)

-If you see rEA or a number, press MD until you see SEt

-With SEt on the screen press SEL, Prc will now be on the screen. See [Detail A.](#)

-With Prc on the screen, press MD three times to go to units of measure unt. See [Detail B.](#)

-With unt on the screen press SEL. See [Detail C.](#)

-Use MD and SEL to toggle between Yards (YDS) and Meters(M). See [Detail D.](#)

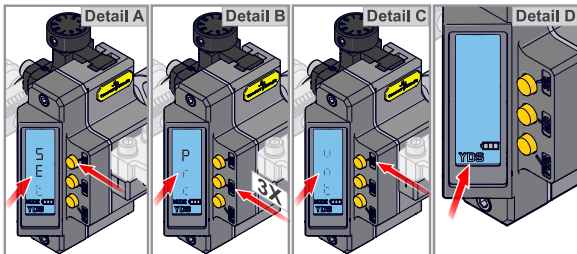

-With the unit of measure on the screen YDS or M hold SEL for the desired type

- The letters will stop flashing, release SEL and return to unt. You have now set the unit of measure

- Press and hold MD, unt will flash release MD SET will appear.

- Press and hold MD SET will flash, release MD and it will return to the numbers and active mode.

NOTE

If at anytime you wish to start over press and hold the MD button until you see rEA or SEt

NOTE

The sight should come set up to be in Right hand or Left hand depending on the sight you purchased. **This section is for troubleshooting only.**

SETTINGS - ORIENTATION Left or Right hand (ori)

- If you see rEA press MD, you will then see SEt, if you see a number, press and hold MD until it flashes. Then you will see rEA, press MD to get SEt.
- With SEt on the screen press SEL, Prc will now be on the screen. See [Detail A](#).
- With Prc on the screen, press MD 4 times to go to units of measure ori. See [Detail B](#).
- With ori on the screen press SEL. See [Detail C](#).
- Use MD and SEL to toggle between right hand (rgt) and left hand (Lft). See [Detail D](#).
- With the unit of measure on the screen rgt or Lft hold SEL for the desired type
 - The letters will stop flashing, release SEL and return to ori. You have now set the left or right hand
 - Press and hold MD, unt will flash release MD SEt will appear.
 - Press and hold MD SET will flash, release MD and it will return to the numbers and active mode

NOTE

If at anytime you wish to start over press and hold the MD button until you see see rEA or SEt

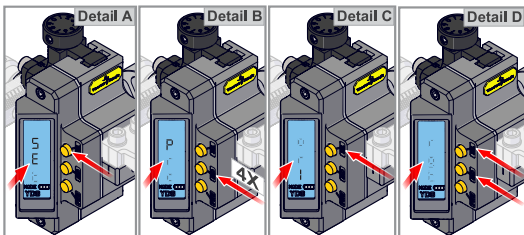

SETTINGS - PROFILES (Pro)

- If you see rEA press MD, you will then see SEt, if you see a number, press and hold MD until it flashes. Then you will see rEA, press MD to get SEt.
- With SEt on the screen press SEL, Prc will now be on the screen. See [Detail A](#)
- With Prc on the screen, press MD five times to go to Profiles Pro See [Detail B](#).
- With Pro on the screen press SEL. See [Detail C](#).
- Use MD and SEL to toggle between 5 different profiles PO1,PO2,PO3,PO4,PO5 See [Detail D](#).
- With the profile on the screen PO1, PO2,PO3,PO4, PO5 hold SEL for the desired profile.
- The letters will stop flashing, release SEL and return to Pro. You have now selected a new profile.
- Press and hold MD, Pro will flash release MD, SEt will appear.
- Press and hold MD SET will flash, release MD and it will return to the rEA mode.
- Once you have chosen a new profile, you MUST return to the beginning steps of Yardage or Speed Set up to set up the new profile. In choosing a new profile you must enter new distances and or a new bow and arrow set up speed.

NOTE

Once you have chosen a new profile, you MUST return to the beginning steps of Yardage or Speed Set up to set up the new profile. In choosing a new profile you must enter new distances and or a new bow and arrow set up speed.

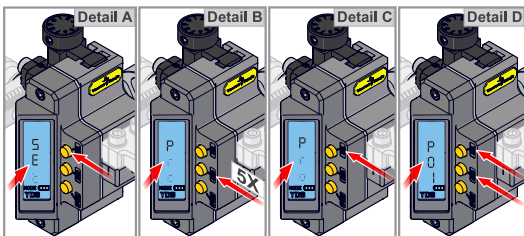

NOTE

Each different profile, has been added to make the sight usable in all hunting seasons or set ups, with different bow speeds due to arrow types or weights.

WARNINGS

CAUTION

Changes or modifications not expressly approved by the party responsible for compliance could void the user's authority to operate the equipment.

Note: This equipment has been tested and found to comply with the limits for a class B digital device, pursuant to part 15 of the FCC Rules. These limits are designed to provide reasonable protection against harmful interference.

This equipment generates, uses and can radiate radio frequency energy and, if not installed and used in accordance with the instructions, may cause harmful interference to radio communications. However, there is no guarantee that interference will not occur in a particular installation. If this equipment does cause harmful interference to radio or television reception, which can be determined by turning the equipment off and on, the user is encouraged to try to correct the interference by one of the following measures:

- Reorient or relocate the receiving antenna.
- Increase the separation between the equipment and receiver.
- Connect the equipment into an outlet on a circuit different from that to which the receiver is connected.
- Consult the dealer or an experienced radio/TV technician for help.

If you need additional assistance, please call our customer service team at 1-800-694-9494.

TROPHY RIDGE WARRANTY

Trophy Ridge™ provides a Limited Lifetime Warranty on its products. All products are covered against breakage due to defects in materials, and workmanship from the date of purchase. Abuse or alteration of the product voids the warranty.

In the event of breakage due to defects in materials or workmanship the liability of Trophy Ridge shall be limited to the lesser of the cost of repairing, or replacing the broken part. In any event, the cost shall never exceed the original retail price of the product. Failure to follow all recommended installation instructions of any Trophy Ridge product may void this warranty.

ORIGINAL OWNER:

Warranty applies only to the original owner, and is not transferable.

ITEMS NOT COVERED:

Fiber optic breakage or modification is never covered under warranty. Some discontinued product models may have a warranty fee attached to rebuild, repair, or modification work done by Trophy Ridge..

DAMAGE NOT COVERED:

Although Trophy Ridge warrants all products are free from defects in materials or manufacturing, however, Trophy Ridge is not responsible for personal/property harm to you, any equipment, or others due to misuse, misapplication, improper installation, or any other form of misuse or abuse of a Trophy Ridge product. It is strongly recommended that any installation of any Trophy Ridge product is done by an experienced, qualified, and competent Pro Shop for the safety of you and your equipment.

WE STAND BY OUR PRODUCTS

In the event an item requires warranty service, please contact Trophy Ridge Customer Support at 1-800-694-9494 for a return authorization (RA) number and return shipping instructions.

Key Contact data

Dealer 800 Number: 800-694-9494

Dealer Fax Number: 812-467-1245

Web: www.TrophyRidge.com

©2022 Trophy Ridge

2L-7990-00