

CROSSBOWS
Bear™

INTENSE
"STRATA" & "STOKE"
Owner's Manual



*Actual model may differ in color and features.

2200 Stringtown Rd.
Evansville, IN 47711
800 - 694 - 9494
fax 812 - 467 - 1245
www.BearArchery.com

SAFETY

Crossbows should only be used if the shooter is properly trained in safety or under the direct supervision of a competent instructor. You **MUST ALWAYS** follow the safety warnings and instructions provided in this manual and any updates at beararchery.com.

The Manual should always accompany your BEAR X Crossbow and must be transferred upon change of ownership or when used by another person.



WARNING

Your New BEAR-X Crossbow is a lethal and deadly weapon that is intended for hunting and target shooting only.

ALWAYS keep your finger off the trigger until you are ready to fire.

ALWAYS know your target, and what is beyond.

ALWAYS keep your hands and fingers out of the bowstring path.

ALWAYS keep the operating manual with your BEAR-X Crossbow.

ALWAYS use the arrows recommended for your model of BEAR-X Crossbow

ALWAYS point your BEAR-X Crossbow in a safe direction.

HAND & FINGER SAFETY

Crossbows designs inherently travel along a path on the rail at an extreme high speed. As a result, the bow string has a large amount of high-energy and will cause significant injury if it contacts any part of the body during release. The shooter must keep all body parts away from the path of the bowstring and cable paths.

Pictures 1-4. Improper Hand Position – with your fore-grip positioned as shown you will have a severed hand or finger amputation



Pic 5. Improper Hand Position – with your fore-grip positioned as shown you will have a severed hand or finger amputation



Pic 6. Proper Hand Position – Proper way to hold the fore-grip on your Bear-X crossbow



INDEX

Section A	General Safety Instructions	pg. 5
Section B	Mounting the Scope & Stirrup.....	pg. 6
Section B	Attaching Quiver Mounting Bracket.....	pg. 7
Section B	Attaching Quiver	pg. 8
Section C	Arrows, Nock, and Inspection.....	pg. 9
Section D	Safety and Trigger operation.....	pg. 10
Section E	Cocking.....	pg. 11
Section E	Loading and Unloading.....	pg. 12
Section F	Shooting your Crossbow.....	pg. 13
Section G	Sighting in the Scope.....	pg. 14
Section H	Maintenance.....	pg. 15

Section A – General Safety Instructions

!!!!CAREFULLY READ THE COMPLETE MANUAL!!!!

Your New BEAR-X Crossbow is a lethal and deadly weapon that is intended for hunting and target shooting. Use for other purposes will cause **serious injury or death**.

It is your responsibility for the safe operation of you Bear- X Crossbow. For your safety and the safety of bystanders you must always remain aware of the inherent danger of handling your BEAR-X Crossbow.

Please register your product! This will allow Bear to send you important updates about your BEAR-X Crossbow. Register online at <https://beararchery.com/registration>

DANGER

Discharging your Bear-X Crossbow with any part of your body in the path of the bowstring will result in amputation or at least a very serious injury. KEEP fingers below the finger guards and NEVER remove finger guards from your Bear-X Crossbow.

WARNING

To minimize risk of death and serious injury:

- NEVER adjust, modify or deactivate any of the safety features of you Bear-X crossbow.
- NEVER use your Bear-X Crossbow for any purpose other than hunting or target shooting.
- Wear safety glasses while shooting your Bear-X Crossbow.
- KEEP your finger below the finger guards at all times.
- Always handle your BEAR-X Crossbow with care, especially when cocked and loaded.
- Store your Bear-X Crossbow in a locked cabinet or safe, beyond the reach of children.
- Never transport your Bear-X Crossbow cocked and loaded.
- Follow the safety advice and instruction in this manual.
- NEVER totally rely on the safety features of the Bear-X Crossbow, which can be inadvertently moved into an unsafe condition.

CAUTION

Follow the safety advice and instruction in this manual, keep this manual with you BEAR-X Crossbow.

Section B – Mounting the Scope & Stirrup

1. Mount Scope as shown in Detail B1.



2. Attach the Stirrup to the riser by using the 2 longer set screws. Make sure the flat of the Stirrup is facing the bottom of the bow and is aligned with the set screw holes on the bottom of the riser. See Detail B2.



Section B – Attaching Quiver Mounting Bracket

3. Screw the Quick Detach **Quiver Mounting Bracket** to the **Mounting Bracket Assembly** using the provided screws. See **Detail B3**.



4. Tighten the Quick Detach **Quiver Mounting Bracket** to the **Mounting Bracket Assembly** using the provided Allen Wrench. See **Detail B4**.



5. Attach the Quick Detach **Quiver Mounting Bracket Assembly** to the underside of the bow in front of the grip. See **Detail B5**.

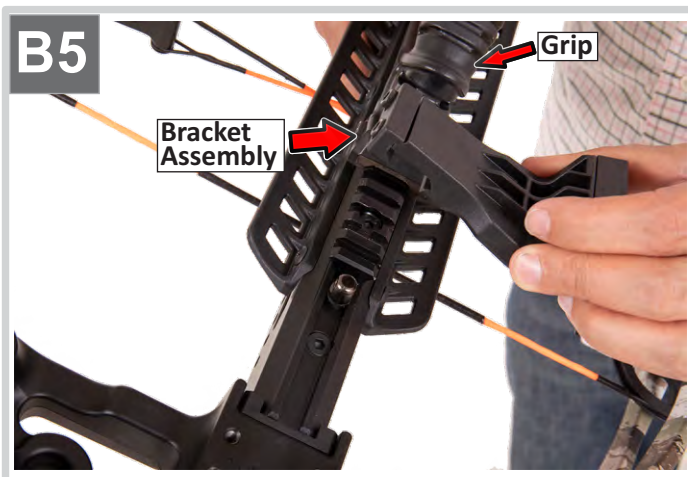

6. Tighten the Quick Detach **Quiver Mounting Bracket Assembly** using the provided screws and Allen Wrench. See **Detail B6**.



Section B – Attaching Quiver

7. Insert the Quiver, by sliding it into the Mounting Bracket until it hits the stop. See **Detail B7 & B8**.

Note: Quiver Hood points towards foot stirrup.



8. Close the latch as shown. This will lock the quiver to the bracket as shown in **Detail B9 & B10**.



Section C – Arrows, Nock, and Inspection

NOTICE

Your Bear-X crossbow was shipped with and require the use of 370-grains True-X arrows. Failure to use TRUE-X nocks and arrows with a weight less than 370-grains will void your warranty and could cause a partial dry-fire that could result in serious personal injury.



WARNING

- Each time inspect arrows for damages before shooting, look for fractures and hairline cracks. Firing damaged arrows can cause serious injury to you or others.
- Only use TRUE X nocks, on narrow axle to axle crossbows. All other nocks will cause a dangerous dry-fire condition that will damage your crossbow or cause serious personal injury.
- Use only standard weight arrows, do not use arrows with a minimum weight of less than 370-grains in your Bear-X crossbow. Using lighter arrows than 370-grains will cause a dry-fire effect that will cause limbs to break resulting in serious personal injury.
- Visually inspect each arrow before use every time, look for nock and vane damage. Inspect for bent and damaged shafts, firing a damaged arrow can cause serious personal injury and will damage your Bear- crossbow.

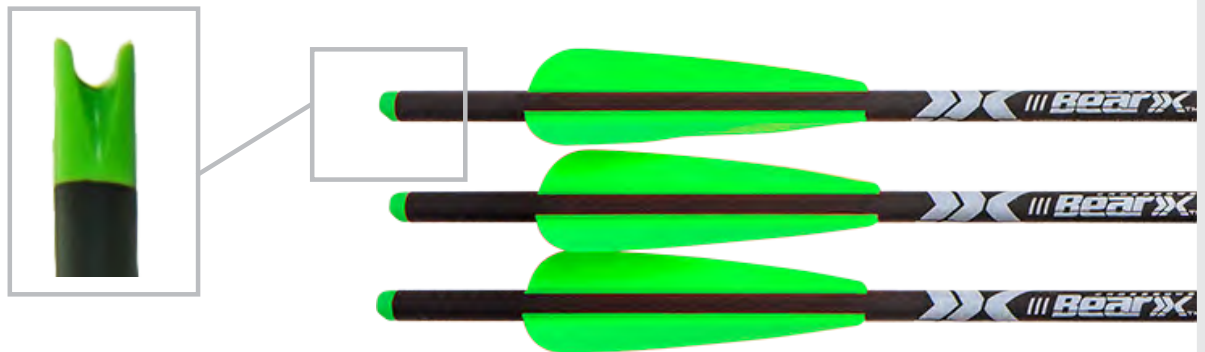

Section D - Safety and Trigger operation

9. Note the location of the safety indicator. F (red dot) = fire and S (green dot) means safety is on. See Picture D1 below and detail D2.

ONCE COCKED:

When cocked the anti-dry fire switch will move from "ON" to "OFF", and the safety catch from "FIRE" to the "SAFE" position.

10. When you receive the crossbow, the dry fire indicator is at "ON" and Safety switch is at "FIRE" position.

11. After cocking, the dry fire indicator will move from "ON" to "OFF", and the safety switch from "FIRE" to "SAFE" position. After loading arrow, dry fire indicator will move from "OFF" to "ON", and the safety switch will remain at "SAFE". When you are ready to shoot, move the safety indicator from "SAFE" to "FIRE" position and pull trigger.



Section E - Cocking

NOTICE

Make sure that you apply rail lube to the rail before cocking. Before use, lubricate the string serving and rail with lubricant. Failure to do so will result in premature string wear, parts should be re-lubricated every 10 to 15 shots. See "Maintenance" section **page 14** for additional information.

- 12.** Place rope cocker in the loop holder See Detail **E1**. Place a foot securely inside the stirrup and grasp both rope cocker handles See Detail **E2**. Reach down and attach the hooks to the string from its underside. As you grasp the Rope cocker handles, press the hooks flush against the sides of the barrel to ensure you will draw the bowstring straight as shown in Detail **E3**.

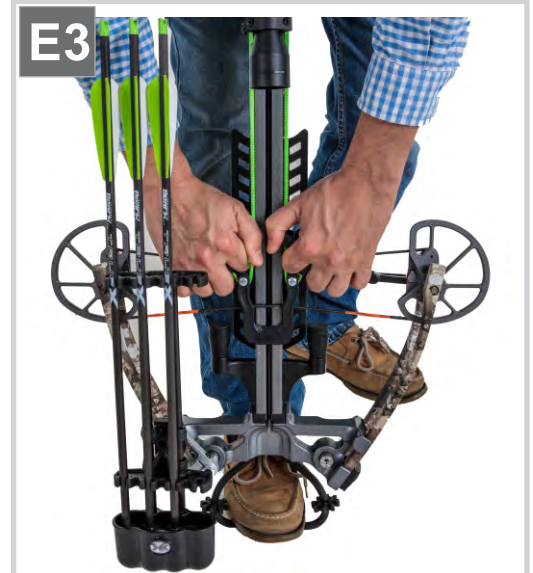
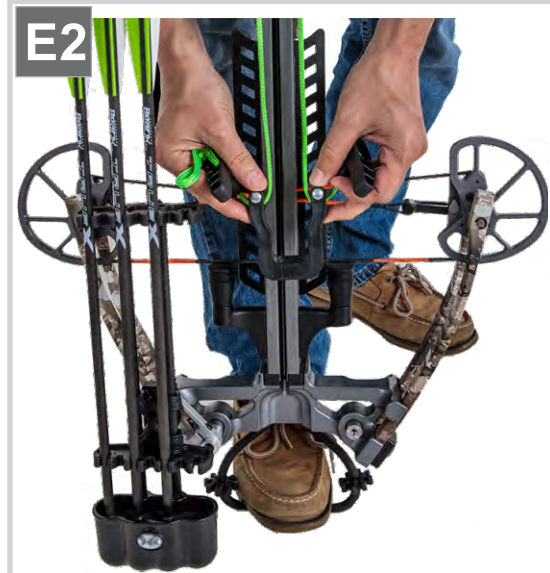

- 13.** At the same time standup and pull up on the rope cocker handles until the bowstring engages the trigger-safety and the string latch engages the bowstring. See Details **E4** & **E5**.

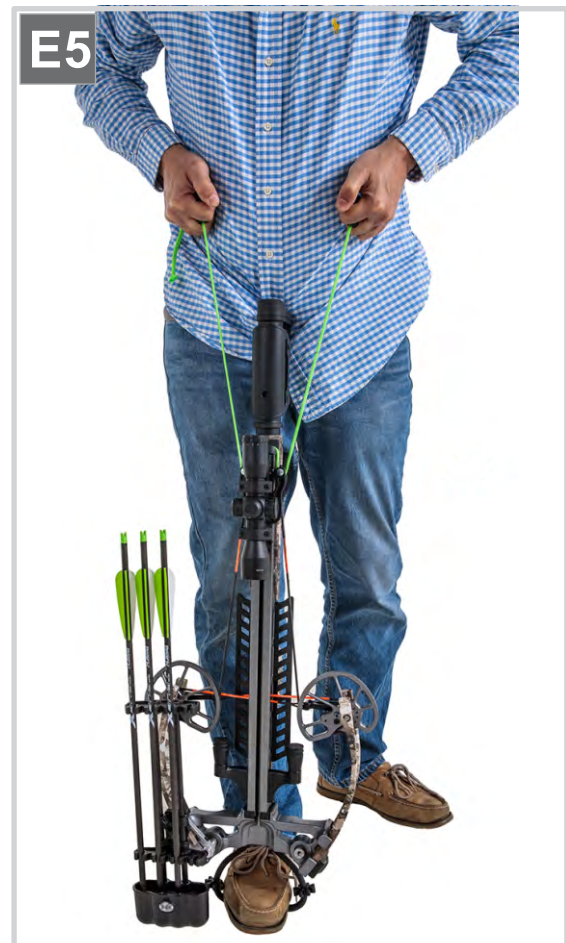
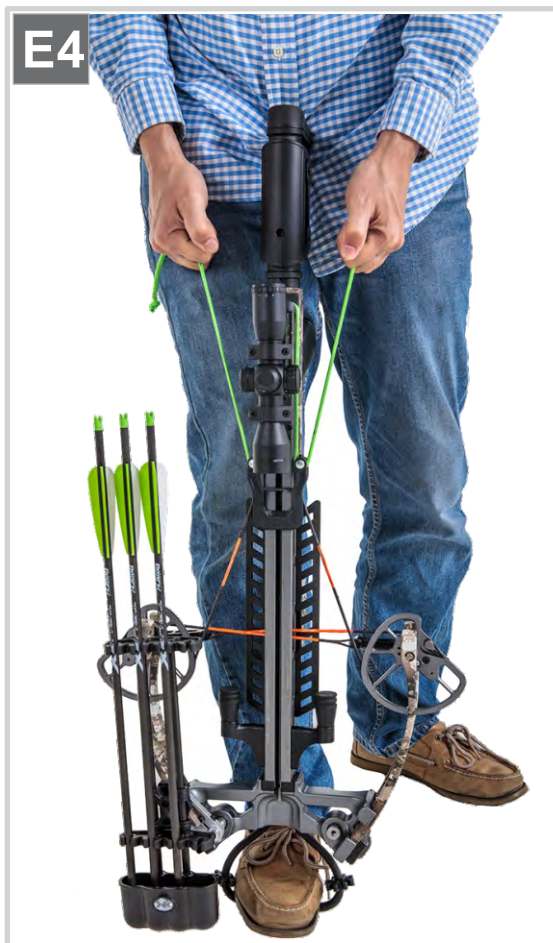

Section E - Loading

14. When loading an arrow, hold it between your index and middle fingers and your thumb, close to center of the arrow. This method keeps your fingers away from the path of the bowstring. Insert the white vane into the barrel's flight groove as shown in Detail E6.
15. Slide the nock end of the arrow under the arrow retention spring/retention brush and lower the front of the arrow into the barrel's flight groove. Continue sliding the arrow shaft into the trigger box's string slot until it stops against the bowstring. At this point, your hand and fingers should be safely in front of the end of the bowstring's release path and out of harm's way. See Detail E6.



Section E - Unloading

WARNING

- DO NOT de-cock crossbow by hand, with cocking rope, crank cocker or by any other means other than shooting an arrow or appropriate discharge arrow.

16. The safest way to unload crossbow is to fire the arrow into suitable target or rock-free ground. If firing into ground, make sure ground is not frozen or hard and shoot at point approximately 4 to 5 feet in front of you at a 45 degree angle. Firing at greater distances may result in lost arrow in dirt or ricochet.

NOTE: Never leave Bear-X crossbow cocked more than 12 hours. See "General Maintenance" section on **page 14** for additional information.

Section F- Shooting your Crossbow

DANGER

To avoid serious personal injury or finger amputation always keep clear of the bowstring path and below the finger guards.

You must read and understand **Section A – General Safety, Section D - Safety and Trigger Operation, and Section E Cocking, Uncocking, Loading and Unloading.**

WARNING

- Follow the safety advice and instruction in this manual.
- Never remove, modify or deactivate the safety features of you Bear-X crossbow.
- Wear safety glasses.
- Do not fire your Bear-X crossbow if it is not in proper working condition, if you have any question contact customer service at 800-694-9494.
- Never move the safety to the fire until you are ready to fire.
- Never allow someone to use your Bear-X crossbow without first reading the manual.
- Inspect your crossbow prior to every use. Never shoot a damaged crossbow.
- Do not consume drugs or alcohol before or while using your crossbow. Your vision and judgement will be seriously impaired, making you unsafe.
- Be Sure of Your Target and What's Beyond It.
- Be certain your backstop will stop the arrow while target shooting.
- Don't Rely on Your crossbow Safety, which can be inadvertently moved into the fire position.

1. Determine the yardage to the target, it should be 10 yards for the first time shooting you Bear-X crossbow.
2. Cock and load your crossbow as described in Section E - Cocking, Loading and Unloading.
3. Point your loaded crossbow toward the intended target with one hand on the fore-grip and the other hand on the stock.
4. Ensure your fingers and hands are not in the bowstring path and are positioned below the safety guards.



Section G - Sighting in the Scope

DANGER

To avoid serious personal injury or finger amputation always keep clear of the bowstring path and below the finger guards.

WARNING

You must read and understand **Section A – General Safety, Section D - Safety and Trigger Operation, and Section E – Shooting Your Crossbow** sections of the manual to avoid serious property damage, personal injury or loss of life.

Sight your crossbow at 10 yards. You will be sighting in the TOP CIRCLE on your scope of the shortest distance. The other circles below the top one will offer you additional yardage sight points, the lower the circle the further the distance. These distances will depend on your initial yardage sighting of the top circle, and depend on your bolt (bolt shaft length, size and weight of tip).

Windage adjustment knob:

Arrow striking right, adjust windage wheel CLOCKWISE

Arrow striking left, adjust windage wheel COUNTER-CLOCKWISE.

Adjustment Scale: 1 Click – $\frac{1}{4}$ " @ 100 yards.

Scope Features:

A: Object End

B: Windage Adjustment

C: Elevation Adjustment

D: Battery Compartment Cap

E: 7 – Position Rheostat Knob (Not available in all packages)

F: Eyepiece

G: Locking Nuts

Replacement Battery:

Bear-X illuminated scope models use a CR2032 coin style lithium battery. Always remember to turn off the scope when you have finished using it. Always carry a replacement battery.

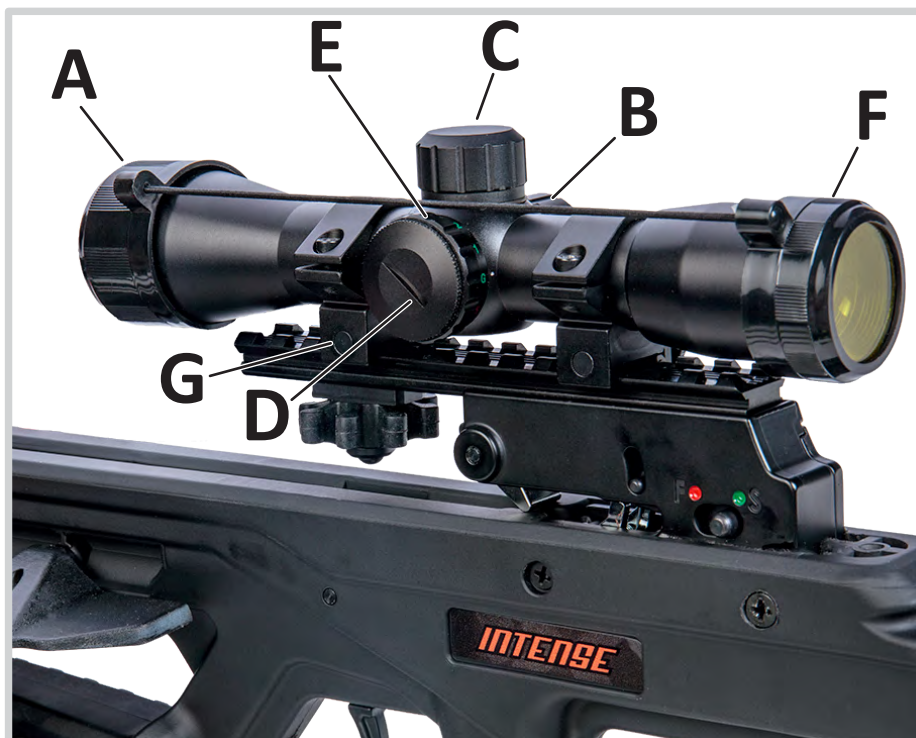

Section H - Maintenance

WARNING

- Wear safety glasses
- Before any maintenance review the finger and hand safety warnings, page 1.
- Never perform maintenance on your Bear-X crossbow in the cocked position, performing maintenance while cocked puts you in extreme danger of serious injury and death.
- Do not modify, make custom adjustment, remove or deactivate safety features. Making modification will void the warranty.
- Do not cock or shot a malfunctioning crossbow, it might cause serious personal injury.
- Do not apply wax to the center serving or trigger because it will collect inside the trigger and might prevent the string from latching properly.
- Never use heavy oil or petroleum grease!

General Maintenance:

1. **General**
 - Check for worn or loose parts
2. **Strings and Cables**
 - Before use, lubricate the string serving and rail with the provided lubricant. Failure to do so will result in premature string wear. Parts should be re-lubricated every 10 to 15 shots. See picture **H1** below.
 - Replace immediately any worn strings, frayed strings, frayed cables and damaged cocking rope.
 - Recommend changing the strings and cables every two years or 450 shots.
3. **Storage**
 - Store your Bear-X crossbow in a locked cabinet or safe location far from the reach of children.
 - Never store your crossbow in a hot area, such as an attic, car truck or next to heat source – long term exposure will damage your crossbow.
 - Never leave Bear-X crossbow cocked inside a vehicle or when stored.
 - Never leave Bear-X crossbow cocked more than 12 hours.
 - Also, storing it in a humid location may cause some parts to rust.
4. **Bolts and Screws**
 - Do not loosen limb bolts to relieve string pressure when not in use.
 - Periodically you might need to tighten scope rings and stock mounts.
5. **Service**
 - To obtain service contact the Customer Service Department at 1-800-694-9494.

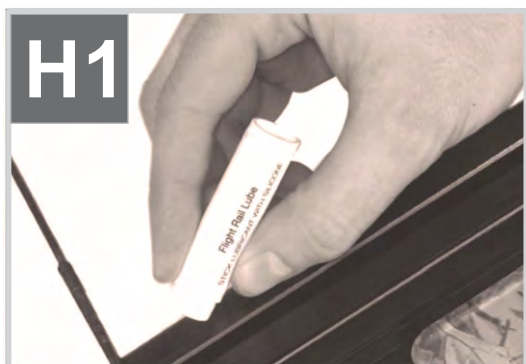

Parts List - Intense Strata / Stoke

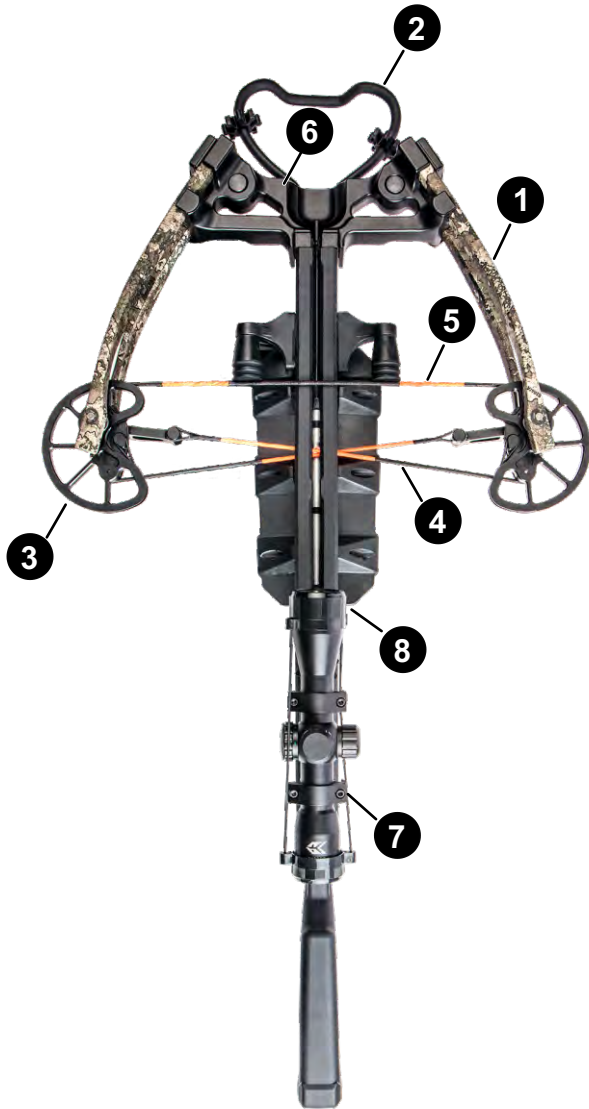

Parts List:

1. Limb
2. Foot Stirrup
3. Cam
4. Cable
5. String
6. Riser
7. Scope
8. Stock

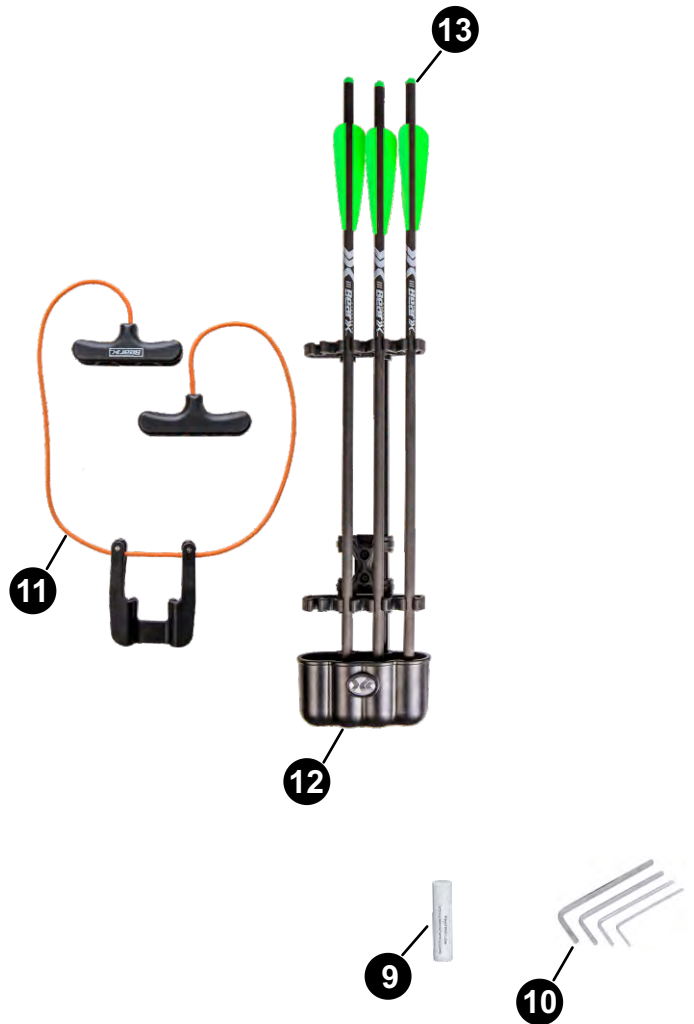

Accessories:

9. Rail Lube
10. Allen Wrenches
11. Rope Cocker
12. Quiver
13. Arrow/Bolt

BEAR ARCHERY WARRANTY STATEMENT

All Bear Archery compound bows are backed with a Limited Lifetime Warranty to the original owner. This warranty applies to limbs, risers, and cams. This warranty consists of the following programs:

Limbs: 100% covered at no charge for the first 5 years, 50% of replacement cost after.

- Risers: Lifetime Warranty.
- Cams: Lifetime Warranty.

Original Owner

Warranty applies only to the original owner and is not transferable. Proof of purchase may be required.

Items Not Covered

Cables, strings, bearings, paint and/or film dipped finishes resulting from normal wear and tear are not included in this warranty.

Damage Not Covered

Damage caused by abuse, mishandling, dry firing, alteration or modification made to original products are not covered under this warranty. The use of any bow press other than those approved by Bear Archery will void this warranty. Additionally, shooting of arrows less than 5 grains per pound of peak draw weight will void this warranty. Bear Archery reserves the right to make parts substitutions on warranty coverage at Bear Archery's sole discretion, for any reason.

Bow Warranty Registration

For this warranty to be in effect, the on-line warranty registration process must be completed at BearArchery.com and submitted within 30 days of purchase.

Traditional Bows

1 year Limited Warranty to the original owner.

Youth Bows

90 Day Limited Warranty to the original owner.

In the event a bow requires warranty service, please contact the Bear Archery Customer Department at 800-694-9494 for a return authorization (RA) number and return shipping instructions. For full warranty details, please log on to BearArcheryProducts.com for further information.