

CROSSBOWS  
**Bear**™

**IMPACT**

**Owner's Manual**



2200 Stringtown Rd.  
Evansville, IN 47711  
800 - 694 - 9494  
fax 812 - 467 - 1245  
[www.BearArchery.com](http://www.BearArchery.com)

## SAFETY

Crossbows should only be used if the shooter is properly trained in safety or under the direct supervision of a competent instructor. You **MUST ALWAYS** follow the safety warnings and instructions provided in this manual and any updates at [beararchery.com](http://beararchery.com).

The Manual should always accompany your BEAR X Crossbow and must be transferred upon change of ownership or when used by another person.



## WARNING

Your New BEAR-X Crossbow is a lethal and deadly weapon that is intended for hunting and target shooting only.

**ALWAYS** keep your finger off the trigger until you are ready to fire.

**ALWAYS** know your target, and what is beyond.

**ALWAYS** keep your hands and fingers out of the bowstring path.

**ALWAYS** keep the operating manual with your BEAR-X Crossbow.

**ALWAYS** use the arrows recommended for your model of BEAR-X Crossbow

**ALWAYS** point your BEAR-X Crossbow in a safe direction.

# HAND & FINGER SAFETY

Crossbows designs inherently travel along a path on the rail at an extreme high speed. As a result, the bow string has a large amount of high-energy and will cause significant injury if it contacts any part of the body during release. The shooter must keep all body parts away from the path of the bowstring and cable paths.

**Pictures 1-4.** Improper Hand Position – with your fore-grip positioned as shown you will have a severed hand or finger amputation

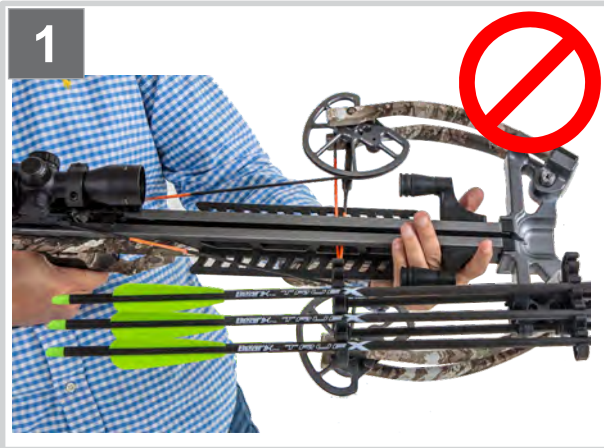

**Pic 5.** Improper Hand Position – with your fore-grip positioned as shown you will have a severed hand or finger amputation



**Pic 6.** Proper Hand Position – Proper way to hold the fore-grip on your Bear-X crossbow



## INDEX

Parts List Bear X-Impact .....	pg. 5
General Safety Instructions .....	pg. 6
Section A Front-end and Stock Assembly.....	pg. 7-8
Section B Mounting the Scope, Quiver & Stirrup.....	pg. 9
Section B Detaching Quiver / Rotating Quiver.....	pg. 10
Section C Arrows, Nock, and Inspection.....	pg. 11
Section D Safety and Trigger operation.....	pg. 12
Section E Attaching Cranking Device & Cocking.....	pg. 13-17
Section E Loading and Unloading.....	pg. 18
Section F Shooting your Crossbow.....	pg. 19
Section G Detailed Scope Instructions.....	pg. 20-21
Section H Maintenance.....	pg. 22
Warranty .....	pg. 23

# Parts List - Impact

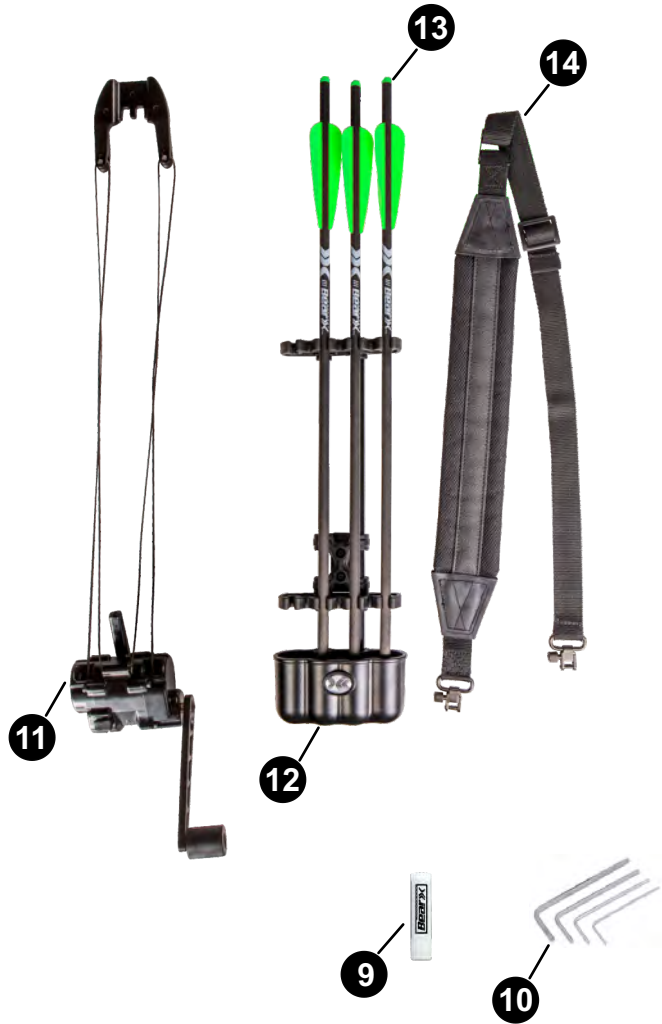
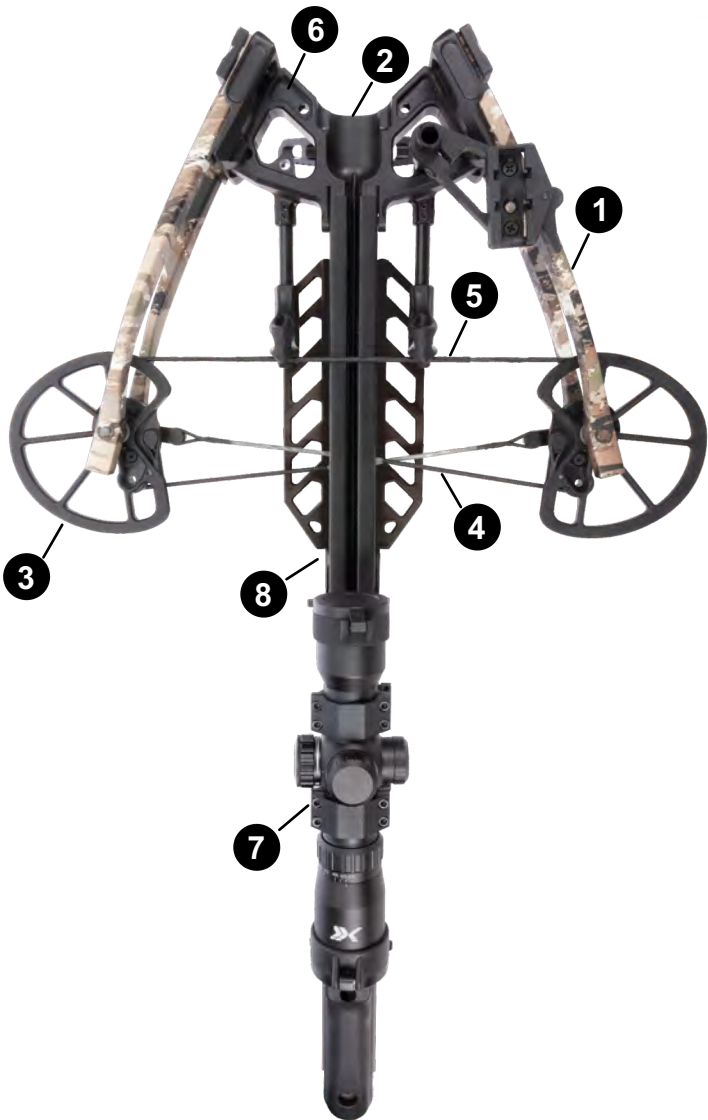

**Parts List:**

- 1. Limb
- 2. Folding Stirrup/Rest
- 3. Cam
- 4. Cable
- 5. String
- 6. Riser
- 7. Scope
- 8. Stock

**Accessories:**

- 9. Rail Lube
- 10. Allen Wrenches
- 11. Silent Crank
- 12. Quiver
- 13. Arrow/Bolt
- 14. Shoulder Sling

# General Safety Instructions

## !!!!CAREFULLY READ THE COMPLETE MANUAL!!!!

Your New BEAR-X Crossbow is a lethal and deadly weapon that is intended for hunting and target shooting. Use for other purposes will cause **serious injury or death**.

It is your responsibility for the safe operation of you Bear- X Crossbow. For your safety and the safety of bystanders you must always remain aware of the inherent danger of handling your BEAR-X Crossbow.

Please register your product! This will allow Bear to send you important updates about your BEAR-X Crossbow. Register online at <https://beararchery.com/registration>

## **DANGER**

**Discharging your Bear-X Crossbow with any part of your body in the path of the bowstring will result in amputation or at least a very serious injury. KEEP fingers below the finger guards and NEVER remove finger guards from your Bear-X Crossbow.**

## **WARNING**

### To minimize risk of death and serious injury:

- NEVER adjust, modify or deactivate any of the safety features of you Bear-X crossbow.
- NEVER use your Bear-X Crossbow for any purpose other than hunting or target shooting.
- Wear safety glasses while shooting your Bear-X Crossbow.
- KEEP your finger below the finger guards at all times.
- Always handle your BEAR-X Crossbow with care, especially when cocked and loaded.
- Store your Bear-X Crossbow in a locked cabinet or safe, beyond the reach of children.
- Never transport your Bear-X Crossbow cocked and loaded.
- Follow the safety advice and instruction in this manual.
- NEVER totally rely on the safety features of the Bear-X Crossbow, which can be inadvertently moved into an unsafe condition.

## **CAUTION**

Follow the safety advice and instruction in this manual, keep this manual with you BEAR-X Crossbow.

## Section A – Front-end and Stock Assembly

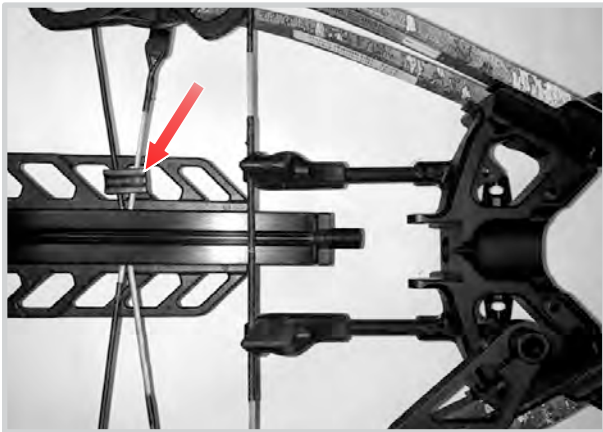

1. Be sure the cable slide is properly attached to the cables and locate as shown.

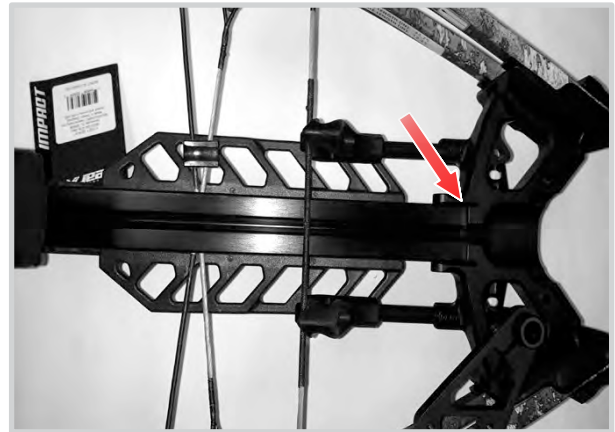

2. Mate the front-end to the stock assembly

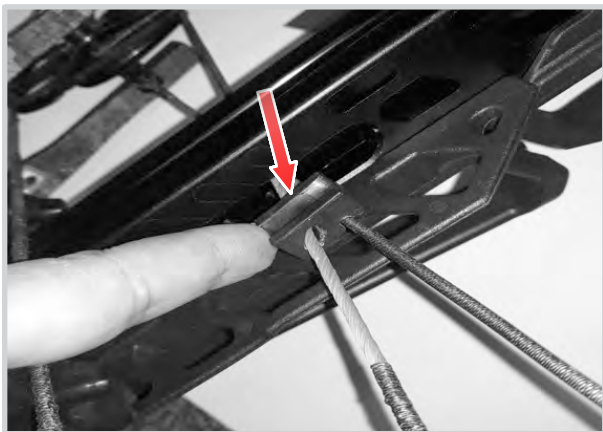

3. Locate the cable slide as shown

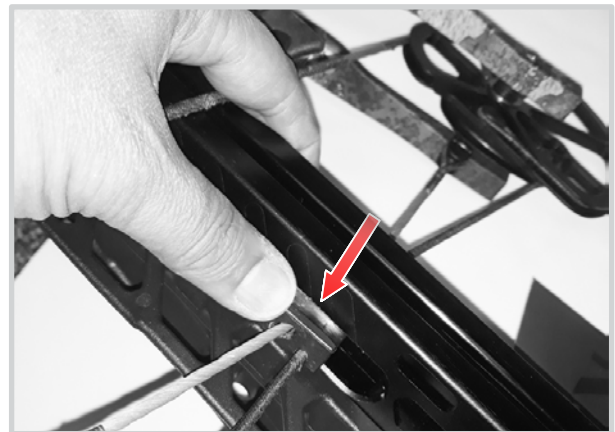

4. Slide the cable slide in to stock assembly. Apply slight downward if needed.



5. Properly install cable slide



6. Install and tighten the Riser bolt firmly.

## Section A – Front-end and Stock Assembly - Continued

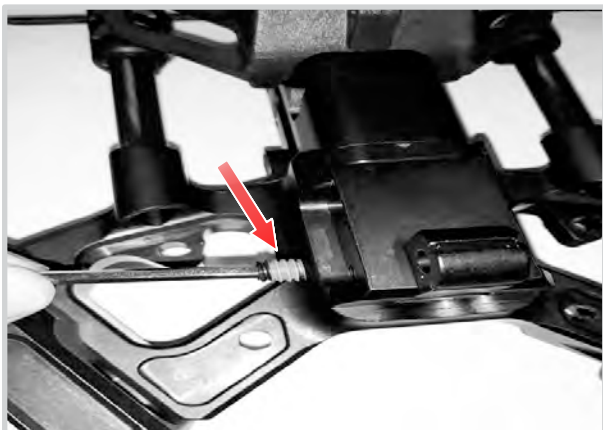

7. Install the 1/4"x1/4" Set Screw (this must be installed, locks the riser bolt in place)



8. Install 2X riser support screws

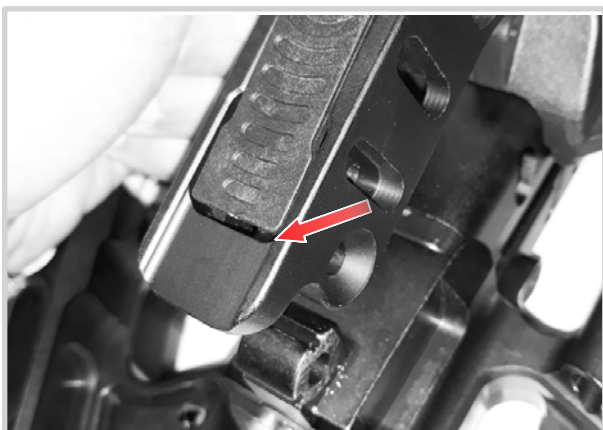

9. Mate the stirrup as shown.

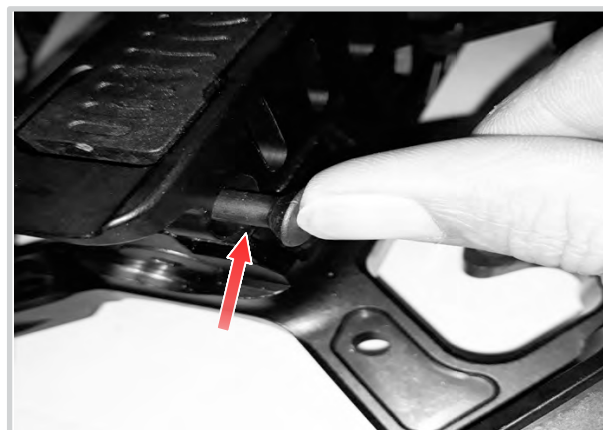

10A. Insert bolts as shown.



10B. Tighten stirrup bolts.



## Section B – Mounting the Scope, Quiver & Stirrup

1. Unfold the Stirrup/Rest as shown in Detail B1.



2. Mount Scope as shown in Detail B2. See page 18 for complete scope guide.



3. Attach Quiver as shown in Detail B3.



## Section B – Detaching Quiver / Rotating Quiver

4. To detach quiver pull up on the quiver release lever (See B4) and detach quiver as shown in Detail B5.

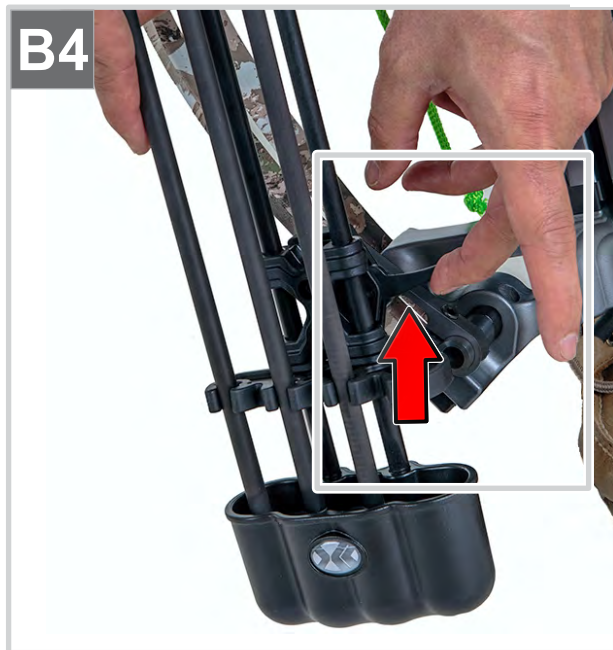

5. To rotate the quiver loosen bracket with an allen wrench (See B6) then rotate quiver as shown in Detail B7.

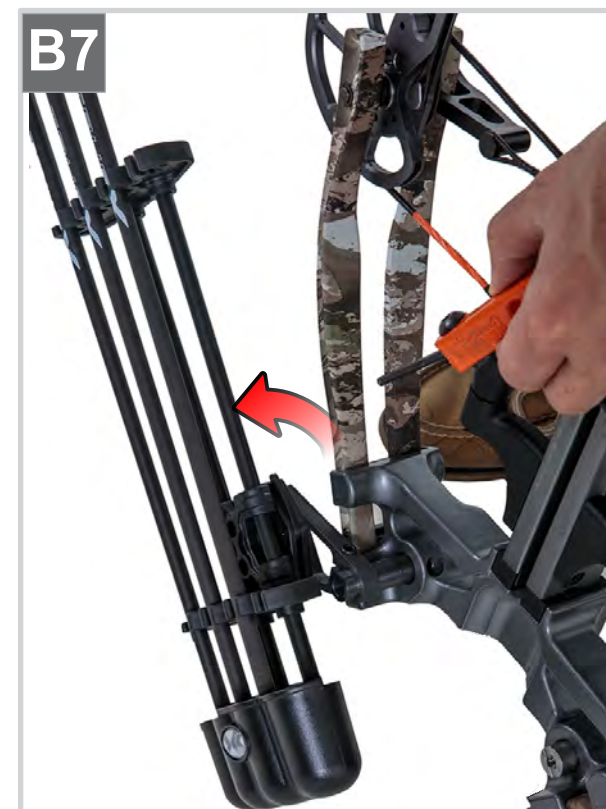
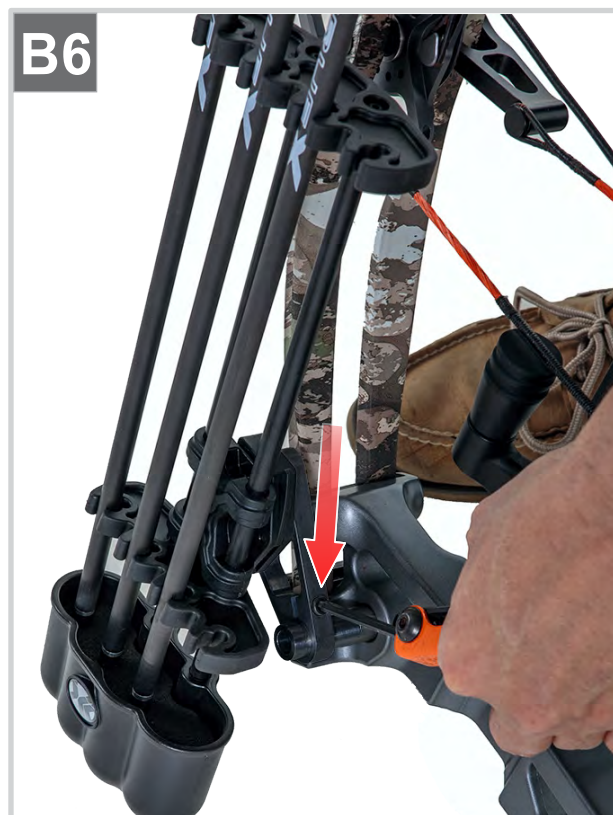

## Section C – Arrows, Nock, and Inspection

### NOTICE

Your Bear-X crossbow was shipped with and require the use of 370-grains True-X arrows. Failure to use TRUE-X nocks and arrows with a weight less than 370-grains will void your warranty and could cause a partial dry-fire that could result in serious personal injury.



### WARNING

- Each time inspect arrows for damages before shooting, look for fractures and hairline cracks. Firing damaged arrows can cause serious injury to you or others.
- Only use TRUE X nocks, on narrow axle to axle crossbows. All other nocks will cause a dangerous dry-fire condition that will damage your crossbow or cause serious personal injury.
- Use only standard weight arrows, do not use arrows with a minimum weight of less than 370-grains in your Bear-X crossbow. Using lighter arrows than 370-grains will cause a dry-fire effect that will cause limbs to break resulting in serious personal injury.
- Visually inspect each arrow before use every time, look for nock and vane damage. Inspect for bent and damaged shafts, firing a damaged arrow can cause serious personal injury and will damage your Bear- crossbow.

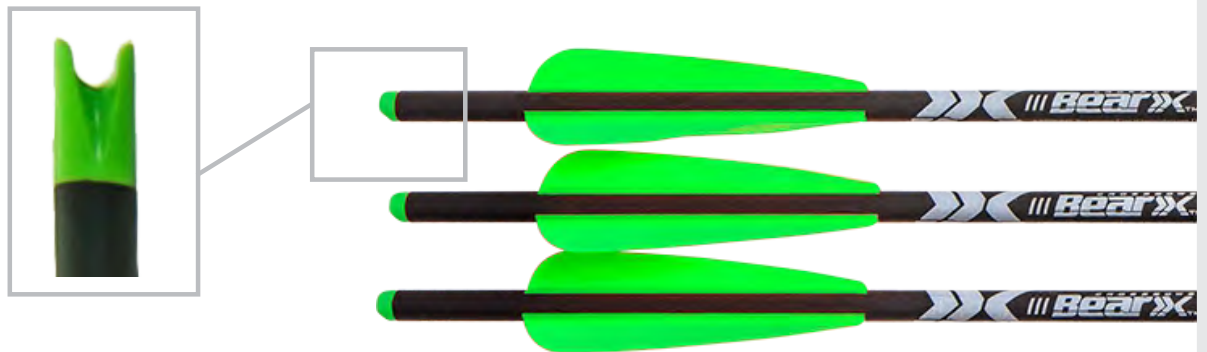

## Section D - Safety and Trigger operation

6. Note the location of the safety indicator. F (red dot) = fire and S (green dot) means safety is on. See Picture D1 below and detail D2.

### ONCE COCKED

When cocked the anti-dry fire switch will move from "ON" to "OFF", and the safety catch from "FIRE" to the "SAFE" position.

7. When you receive the crossbow, the dry fire indicator is at "ON" and Safety switch is at "FIRE" position.
8. After cocking, the dry fire indicator will move from "ON" to "OFF", and the safety switch from "FIRE" to "SAFE" position. After loading arrow, dry fire indicator will move from "OFF" to "ON", and the safety switch will remain at "SAFE". When you are ready to shoot, move the safety indicator from "SAFE" to "FIRE" position and pull trigger.



## Section E- Attaching Cranking Device, Cocking & Decocking

### NOTICE

Make sure that you apply rail lube to the rail before cocking. Before use, lubricate the string serving and rail with lubricant. Failure to do so will result in premature string wear, parts should be re-lubricated every 10 to 15 shots. See "Maintenance" section **page 20** for additional information.

### USAGE OF SILENT COCKING CRANK DEVICE

1. Insert stub in the hole in the back of the stock as shown below:

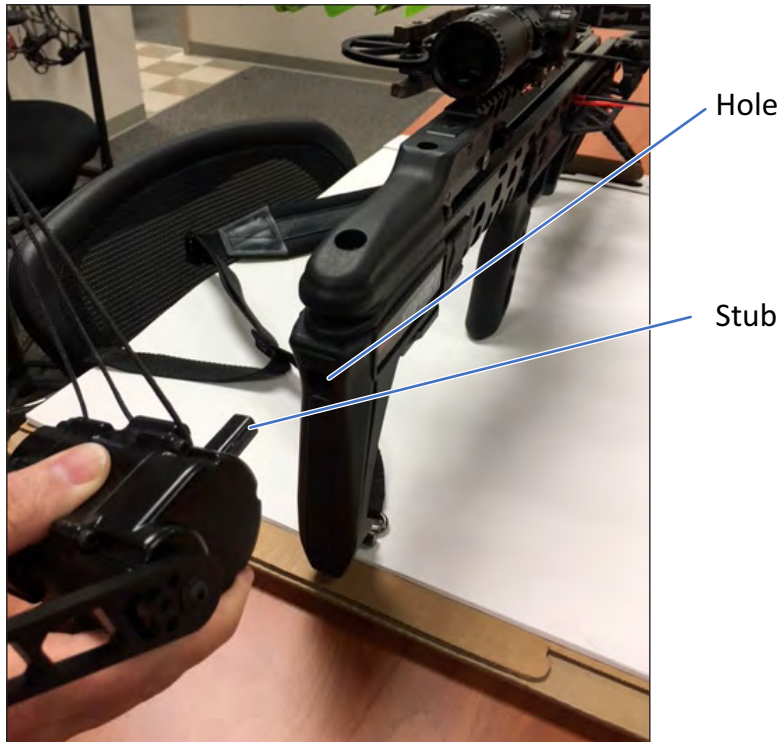

2. Install Silent Cocking Device in the mounting hole.



3. Attach the cocking sled, attach the hooks to the string from its underside – press the sled flush against the rail to ensure the sled is setting square. Note: Ensure that the ropes are positioned correctly and check to make sure the ropes are not twisted or obstructed.

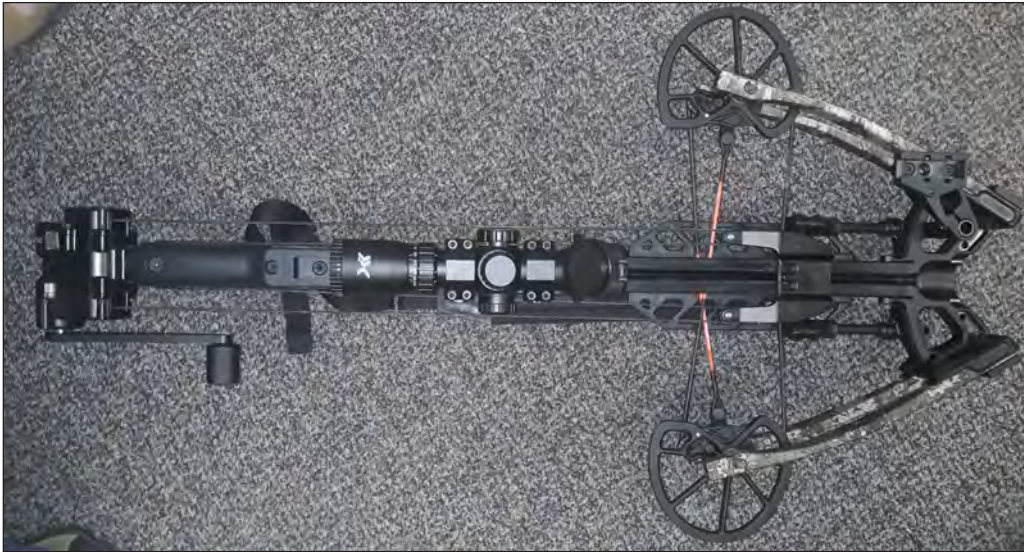

To unspool string on the cocking device, move the thumb trigger to the unlock position and then rotate the handle counterclockwise.



4. Grasp the stock and then turn handle clockwise several times to apply light pressure to secure the cocking sled on the bowstring.



5. With one foot through the foot stirrup, firmly grip the rearward most portion of the crossbow stock with the other hand used to help secure while cocking. Turn the crank handle clockwise until the cocking sled fully pulls the bowstring into the "SAFE" position. Once the safety moves to the "SAFE" position stop turning the handle.

**WARNING: THE CROSSBOW IS NOW FULLY COCKED.**



6. While applying slight pressure on the crank handle in the clockwise position, depress the paw down, unwind the crank a few times to release pressure on the cocking sled.

## **! WARNING**

If the string is not latched on the trigger, the handle will unspool violently and cause serious injury.

Control of the handle must be maintained!



7. Remove the Silent Cocking Device from the mount location. Prior to storage – snug the sled to crank body.





\*\*\*\*\***IMPORTANT**\*\*\*\*\*

You must maintain control of the handle at all times!

To decock with the silent cocking device:

- 1) Ensure the Crossbow does not have an arrow loaded.
- 2) Install Cocker onto crossbow.
- 3) Rotate cocker handle forward to apply load to sled and pull crossbow sled into trigger mechanism. Continue drawing the string until all the draw weight is held by the sled.
- 4) Hold crossbow draw weight with pressure on cocking handle, while switching the free spool toggle forward to the free spool position.
- 5) Draw the crossbow string back to where it just touches the forward position of the trigger safety mechanism and hold the string in this position. You must hold the string in front of the safety mechanism so it can be turned off. If you hold the string too far back in the draw length, the safety will not turn off.
- 6) While holding the string back with the cocking handle, positioned directly in front of the safety mechanism, turn the safety to the fire position.
- 7) Once the safety is in the fire position, the free spool toggle is in the free spool position, and you have the crossbow draw weight being held by the pressure on the cocking handle, pull the trigger with you left hand.
- 8) Rotate the cocking handle in reverse to let the crossbow down while holding the trigger in the fire position.
- 9) Remove cocking device once all pressure is off the sled.



## Section E - Loading

1. When loading an arrow, hold it between your index and middle fingers and your thumb, close to center of the arrow. This method keeps your fingers away from the path of the bowstring. Insert the white vane into the barrel's flight groove as shown in Detail E6.
2. Slide the nock end of the arrow under the arrow retention spring/retention brush and lower the front of the arrow into the barrel's flight groove. Continue sliding the arrow shaft into the trigger box's string slot until it stops against the bowstring. At this point, your hand and fingers should be safely in front of the end of the bowstring's release path and out of harm's way. See Detail E6.



## Section E - Unloading



### WARNING

- DO NOT de-cock crossbow by hand, with cocking rope, crank cocker or by any other means other than shooting an arrow or appropriate discharge arrow.

3. The safest way to unload crossbow is to fire the arrow into suitable target or rock-free ground. If firing into ground, make sure ground is not frozen or hard and shoot at point approximately 4 to 5 feet in front of you at a 45 degree angle. Firing at greater distances may result in lost arrow in dirt or ricochet.

**NOTE:** Never leave Bear-X crossbow cocked more than 12 hours. See "General Maintenance" section on **page 20** for additional information.

## Section F- Shooting your Crossbow

### **DANGER**

To avoid serious personal injury or finger amputation always keep clear of the bowstring path and below the finger guards.

You must read and understand **Section A – General Safety, Section D - Safety and Trigger Operation, and Section E Cocking, Uncocking, Loading and Unloading.**

### **WARNING**

- Follow the safety advice and instruction in this manual.
- Never remove, modify or deactivate the safety features of you Bear-X crossbow.
- Wear safety glasses.
- Do not fire your Bear-X crossbow if it is not in proper working condition, if you have any question contact customer service at 800-694-9494.
- Never move the safety to the fire until you are ready to fire.
- Never allow someone to use your Bear-X crossbow without first reading the manual.
- Inspect your crossbow prior to every use. Never shoot a damaged crossbow.
- Do not consume drugs or alcohol before or while using your crossbow. Your vision and judgement will be seriously impaired, making you unsafe.
- Be Sure of Your Target and What's Beyond It.
- Be certain your backstop will stop the arrow while target shooting.
- Don't Rely on Your crossbow Safety, which can be inadvertently moved into the fire position.

1. Determine the yardage to the target, it should be 10 yards for the first time shooting you Bear-X crossbow.
2. Cock and load your crossbow as described in Section E - Cocking, Loading and Unloading.
3. Point your loaded crossbow toward the intended target with one hand on the fore-grip and the other hand on the stock.
4. Ensure your fingers and hands are not in the bowstring path and are positioned below the safety guards.



# Section G - Scope Instructions

## MOUNTING THE SCOPE

Warning: Be sure that the crossbow is not loaded. Always practice safe handling.

1. Fix the rings to the mounting rail - do not completely tighten.
2. Lay the scope into the rings. Before tightening the rings, look through the scope in your normal shooting position. Adjust the scope (forward or backward) until you find the furthest point forward (to ensure maximum eye relief) that allows you to see a full field of view.
3. Rotate the scope in the rings until the horizontal reticle markings are parallel with the crossbow limbs and the elevation turret is on top.
4. Tighten the screws evenly on each side.

Warning: Avoid over tightening the rings. This can damage the scope affecting performance or rendering it inoperable. (16 in/lbs) (1.33 ft/lbs) (1.8 Nm) for ring cap screws and (30 in/lbs) (2.5 ft/lbs) (3.4 Nm) for ring base screws.

Warning: When installing a scope, always ensure that there is adequate eye relief. This will avoid eye injury.

## OCULAR LENS ADJUSTMENT

All scopes are fitted with an adjustable ocular focus. To focus your eye characteristics to the scope, giving a crystal clear picture of the reticle, carry out the following adjustment.

1. Hold the scope about three or four inches from your eye and look through the eye piece at a blank, flatly lit, bright area such as a wall or open sky.
2. If the reticle is not sharply defined instantly, turn the eyepiece (either direction) a few turns. Quickly glance through the scope again. If the focus has improved, but is still not perfect, continue focusing.
3. If the focus became worse, turn it the opposite direction.

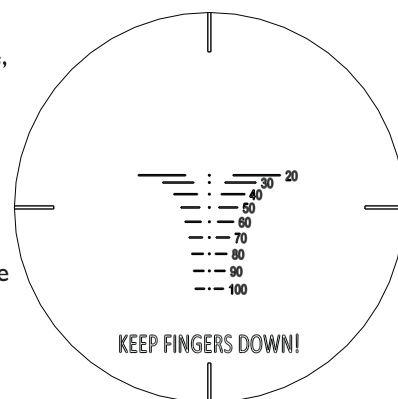

Warning: Never look at the sun with a scope, it may permanently damage your eyes.

## ZEROING YOUR SCOPE

Choose a place to shoot your crossbow with a safe backstop and ensure that no one can step unseen into or in front of the firing line.

Initially, place a target on the backstop at about 10 yards and take a shot at its center. Remove the dust covers from the windage and elevation turrets and make a suitable adjustments to bring the point of impact (POI) closer to the point of aim (POA).

For example - if the bolt has landed lower than required; rotate the elevation turret counter clockwise to raise the point of impact. A high impact point requires a clockwise adjustment.

Both turrets move the POA a 1/2 minute of angle per click – this is equal to 1/2 inch at 100 yards or 1/20th inch at 10 yards.

After achieving an approximate zero at 10 yards, move back to a measured 20 yards and continue adjusting the turrets until the top cross of the reticle and the point of impact are the same. At this range, each click equals 1/10th of an inch (10 clicks to move the impact 1 inch). When you are happy with the 20 yard zero, replace the turret covers.

## Section G - Scope Instructions - continued

### CALIBRATING YOUR SCOPE TO THE CROSSBOW

Adjusting the speed selector also adjusts the magnification. Start by setting it to the manufacturers advertised speed of your crossbow.

Move to a measured 30 yards from the target. Using the 30 yard marker in the scope, (the second crosswire down) shoot the crossbow at the target.

If the bolt impacts the target high, turn the speed selector higher and the next arrow fired will impact the target lower. If the arrow impacts the target lower, turn the speed selector lower and the next arrow fired will impact the target higher.

Once the 30 yard crosswire is sighted in the scope is now calibrated to your crossbow and all of the other aiming points will be correct. At this time, the speed/magnification selector will need to remain in this position to keep the scope and the crossbow calibrated to each other.

Crossbows with speeds over 430 fps and using a lighter bolt combination may require a main crosswire sight-in point of 30 yards instead of the normal 20 yards. This will require calibrating the scope at 40 yards to compensate for the flat trajectory of this combination of components.

### MAGNIFICATION / FPS

SpeedComp: 1.5x = 250, 2x = 285, 2.5x = 315, 3x = 345, 3.5x = 370, 4x = 390, 5x = 430

### ILLUMINATION

The illumination rheostat is located on the side of the saddle.

High brightness settings are recommended for daytime use when ambient light is bright, this will allow the reticle to be visible against dark backgrounds. At times of low light such a dawn or dusk, a lower brightness setting is recommended. The lower settings may not be visible during bright daylight. Reticles are black in the off position or if the battery is defective.

All illuminated scope models use a CR2032 coin style lithium battery. To insert a battery unscrew the battery compartment cap on the top of the rheostat adjustment turret and insert a new battery "+" side up.

**Warning:** Always hold onto the lower half of the rheostat when loosening or tightening the battery compartment cap to ensure no damage is done.

#### Scope Features:

- A: Object End
- B: Windage Adjustment
- C: Elevation Adjustment
- D: Battery Compartment Cap
- E: 7 – Position Rheostat Knob (Not available in all packages)
- F: Eyepiece
- G: Locking Nuts



## Section H - Maintenance

# WARNING

- Wear safety glasses
- Before any maintenance review the finger and hand safety warnings, page 3.
- Never perform maintenance on your Bear-X crossbow in the cocked position, performing maintenance while cocked puts you in extreme danger of serious injury and death.
- Do not modify, make custom adjustment, remove or deactivate safety features. Making modification will void the warranty.
- Do not cock or shot a malfunctioning crossbow, it might cause serious personal injury.
- Do not apply wax to the center serving or trigger because it will collect inside the trigger and might prevent the string from latching properly.
- Never use heavy oil or petroleum grease!

### General Maintenance:

1. **General**
  - Check for worn or loose parts
2. **Strings and Cables**
  - Before use, lubricate the string serving and rail with the provided lubricant. Failure to do so will result in premature string wear. Parts should be re-lubricated every 10 to 15 shots. See picture **H1** below.
  - Replace immediately any worn strings, frayed strings, frayed cables and damaged cocking rope.
  - Recommend changing the strings and cables every two years or 450 shots.
3. **Storage**
  - Store your Bear-X crossbow in a locked cabinet or safe location far from the reach of children.
  - Never store your crossbow in a hot area, such as an attic, car truck or next to heat source – long term exposure will damage your crossbow.
  - Never leave Bear-X crossbow cocked inside a vehicle or when stored.
  - Never leave Bear-X crossbow cocked more than 12 hours.
  - Also, storing it in a humid location may cause some parts to rust.
4. **Bolts and Screws**
  - Do not loosen limb bolts to relieve string pressure when not in use.
  - Periodically you might need to tighten scope rings and stock mounts.
5. **Service**
  - To obtain service contact the Customer Service Department at 1-800-694-9494.

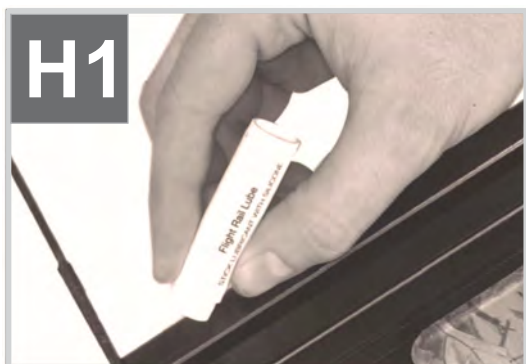

## BEAR ARCHERY WARRANTY STATEMENT

All Bear Archery compound bows are backed with a Limited Lifetime Warranty to the original owner. This warranty applies to limbs, risers, and cams. This warranty consists of the following programs:

Limbs: 100% covered at no charge for the first 5 years, 50% of replacement cost after.

- Risers: Lifetime Warranty.
- Cams: Lifetime Warranty.

### **Original Owner**

Warranty applies only to the original owner and is not transferable. Proof of purchase may be required.

### **Items Not Covered**

Cables, strings, bearings, paint and/or film dipped finishes resulting from normal wear and tear are not included in this warranty.

### **Damage Not Covered**

Damage caused by abuse, mishandling, dry firing, alteration or modification made to original products are not covered under this warranty. The use of any bow press other than those approved by Bear Archery will void this warranty. Additionally, shooting of arrows less than 5 grains per pound of peak draw weight will void this warranty. Bear Archery reserves the right to make parts substitutions on warranty coverage at Bear Archery's sole discretion, for any reason.

### **Bow Warranty Registration**

For this warranty to be in effect, the on-line warranty registration process must be completed at [BearArchery.com](http://BearArchery.com) and submitted within 30 days of purchase.

### **Traditional Bows**

1 year Limited Warranty to the original owner.

### **Youth Bows**

90 Day Limited Warranty to the original owner.

In the event a bow requires warranty service, please contact the Bear Archery Customer Department at 800-694-9494 for a return authorization (RA) number and return shipping instructions. For full warranty details, please log on to [BearArcheryProducts.com](http://BearArcheryProducts.com) for further information.