



BEAR ARCHERY 1978

THE BROTHERHOOD OF THE BOW



If asked to sketch a mental picture of the typical archer I would be hard put. They seem to come in all shapes, sizes, colors, and backgrounds. Inwardly they seem to have in common a love for the outdoors, a reverence for wildlife, and a close tie with history. There is nothing they seem to enjoy more than telling tall tales around a campfire or talking about archery to others. It would be difficult to find a more interesting group of people.

There are currently more than five million active archers in the United States and millions more spread around the world. We are dedicating this catalog to them. And while we can't feature everyone, we would like to show a cross section of today's archers—all related by their love of archery.

Fred Bear

INDEX

Compound Bows:

Tamerlane II (long & short handles) 6,7
 Temujin II 8
 Alaskan 9
 Polar LTD 10
 Kodiak Special 11
 Whitetail Hunter 12
 Blacktail Hunter 13

Recurve and Take-Down Bows:

Grizzly 14
 Bearcat Take-Down Hunter 15
 Tigercat 16
 Black Bear Hunter bow & set 18
 Black Bear Magnum 17
 Bear Take-Down Hunter bow & set 18
 Victor (long & short handles) 20,21
 Bearcat Take-Down 22
 Bear Target Take-Down bow & set 23
 White Bear 24
 Little Bear bow & set 25

Fiberglass Sets:

Red Bear 26
 Golden Bear 26

Bowfishing Equipment:

Bowfishing reels, arrows points and rigs 27

Arrows:

Outfitting tips 28,29
 Hunting & Field arrows 29, 30, 31
 Tournament & Field arrows 32, 33

Quivers:

Belt quivers 34
 Bow quivers 35

Accessories:

Gloves, tabs and armguards 36
 Bowcases 37
 Points and nocks 38
 Bowstrings, bowstringers and bow racks 39
 Bowsights 40
 Stabilizers, arrow rests and release aids 41
 Hunting accessories 42
 Targets, target faces and fletching aids 43
 Books and movies 44
 New products 48

Miscellaneous:

Outfitting tips 19
 State Archery associations 45
 Worldwide Archery organizations 46
 Fred Bear Sports Club 46, 47

We are continually seeking to improve all Bear products for your enjoyment and benefit. Toward that end we reserve the right to change specifications without notice at any time we feel they will be of aid to the archer.

Cover Picture:

A warm fire on a cool autumn day to warm one's soul and lunch. Fred Bear rests during a day of deer stalking and makes ready to toast a cheese sandwich. A scene from the New Bear Archery Film "The Good Earth."



TEAM BEAR

Your chance to get in on all the fun . . .

Our newly introduced Team Bear Program is designed to provide the archer using Bear equipment with a sense of identity and to recognize up-and-coming archers on the local level who are shooting Bear products. The program is a direct result of Fred Bear's and Bear Archery's commitment to promote our sport and to encourage participation in local, regional and national archery shoots.

You can participate in Team Bear and win. Team Bear shoots will be held all over the country and will be advertised in major archery publications and tournament promotions. Registration for Team Bear at any meet where it is being held is in addition to the normal shoot. It costs nothing to sign up and the only requirement is that you shoot a Bear bow. Any shooter registered, except members of Pro-Team Bear will be eligible for the awards.

Local shoots will pay \$100 in silver dollars for the highest scratch score and prizes of \$50 and \$25 will be awarded under the "Lewis System" handicap. Prizes will be awarded in both Men's and Women's Divisions. NFAA Sectional Shoots will be the same except cash awards will be \$200, \$100 and \$50 and Major National Shoots will pay \$400, \$200 and \$100.

In addition to cash awards paid in silver dollars, winners will also receive Team Bear shooting shirts and jackets. And at the end of the year a Team Bear Grand Champion will be chosen on the basis of a points system — one for the Men's division and one for the Women's. The winners will be awarded a specially engraved bow of their choice autographed by Fred Bear.

So practice with your bow, put on your colors, and when attending shoots this year look for the Team Bear Headquarters banner and register. We'll be looking for you.

Team Bear Attire

available from your local Bear dealer or directly from Bear Archery. To order, see the return envelope bound into this catalog.

8710 Team Bear Windbreaker

White nylon windbreaker with blue trim and the distinctive Team Bear logo silkscreened on the back. Good looking and an excellent conversation starter. Available in extra small, small, medium, large & extra large.

8715 Team Bear Shooting Shirt

Cotton/Polyester T-shirt with distinctive Team Bear logo silkscreened on the back. Show your colors on the shooting line. Available in small, medium, large and extra large.

8720 Team Bear Applique

small stick-on patch for shirts, jackets, quivers, bowcases, etc.

WARRANTY & AUTHORIZED SERVICE CENTERS PROGRAM

FULL ONE YEAR WARRANTY

Full One Year Warranty

Your Bear Bow is a quality designed and made product. It is warranted against defects in materials (exclusive of string and cables, if any) and workmanship for a period of one (1) year from date of purchase. If within such one (1) year period, a defect shall occur and such defect shall not result from modification of the bow, misuse or improper stringing, Bear will at its option and without cost to you, repair or replace the bow.

To obtain service on any Bear bow other than a compound bow, return it, shipping pre-paid, to Bear Archery, Attn: Factory Customer Service Department, Rural Route One, Grayling, Michigan 49738.

To obtain service on a Bear compound bow, you may send or take it to the nearest authorized Bear Service Center.

This warranty gives you specific legal rights and you may also have other rights which vary from state to state.

BEAR ARCHERY

Subsidiary of Walter Kidde & Company, Inc.
KIDDE

Rural Route One
Grayling, Michigan 49738

Bows used to be relatively simple and our traditional bows still are. But if you own a compound bow of any kind you know that's no longer true. If for any reason your Bear Compound Bow needs servicing, take it or send it to one of these convenient Bear Archery Service Centers located across the country. They're factory trained, fully equipped and carry a stock of Bear Compound Bow parts to do just about any kind of servicing your Bow might require.

ALABAMA

Beavers Archery Center
Birmingham, AL 35212

ARIZONA

Henderson Archery
Phoenix, AZ 85007
Kachina Archery, Inc.
Phoenix, AZ 85029

ARKANSAS

Archery Center
Little Rock, AR 72205

CALIFORNIA

Bonnie Bowman Archery
San Leandro, CA 94577
Arrow Manufacturing
Costa Mesa, CA 92626
Archery Headquarters
El Monte, CA 91732
Pony Express Spt. Goods
Encino, CA 91316
E. & G. Archery
San Jose, CA 95126

COLORADO

American Spts. Club, Inc.
Denver, CO 80223
Blue Cloud Archery
Fl. Collins, CO 80521

CONNECTICUT

Garrison Firearms
Brookfield, CO 06804
Hall's Arrow, Inc.
Columbia, CO 06237

FLORIDA

Southeast n Archery
Orlando, FL 32806
C & G Sporting Goods
Panama City, FL 32401
Miami Indoor Arch. Lanes
Hialeah, FL 33012
Morree Archery &
Taxidermy
Fl. Walton Beach, FL 32548

GEORGIA

Sports Village
Macon, GA 31204
Georgia Archery & Sport
Athens, GA 30601

ILLINOIS

Nack & Feather
Aurora, IL 60504
Chicago Archery Center
Chicago, IL 60635
Griswold Archery Shop
Cameron, IL 61423

ARCHERY CUSTOM SHOP

Forest Park, IL 60130

Tomahawk Archery
Springfield, IL 62702

INDIANA

Joe Giacometto Goodyear
Clinton, IN 47842

HANSON'S SPORTS

Highland, IN 46322

SULPHINS ARCHERY

Indianapolis, IN 46224

McMILLAN SPORTS

Terre Haute, IN 47807

LITTLE JOHN'S ARCHERY

Fl. Wayne, IN 46804

FALL CREEK BAIT & TACKLE

Indianapolis, IN 46205

PAUL'S ARCHERY CENTER

Muncie, IN 47302

IOWA

Woody's Sport & Marine
Des Moines, IA 50311
Bowhunters Supply
Cedar Falls, IA 50613

KENTUCKY

Pape's Hardware, Inc.
Louisville, KY 40219
Hehman General Merchandise
Melbourne, KY 41059

LOUISIANA

Genes Sporting Goods
Monroe, LA 71201
Sport Shop, Inc.
Baton Rouge, LA 70805

MAINE

Kittery Trading Post
Kittery, ME 03904

MASSACHUSETTS

Forest Orchard Archery
Northboro, MA 01532
Tee Pee Archery Tackle Co.
West Newton, MA 02165

MICHIGAN

Erno's Archery Shop
Bay City, MI 48707

2ND LOCATION AT:

3365 W. Freeland Road
Saginaw, MI 48604

JAY'S GUN SHOP

Clare, MI 47817

ANDERSON ARCHERY SALES

Kendal Lodge, MI 48837

MAR-LON ARCHERY

Dearborn, MI 48126

SPRINGER ARCHERY SUPPLY

Romulus, MI 48174

FRED BEAR MUSEUM

Grayling, MI 49738

SPRING BAIT & TACKLE

Muskegon, MI 49440

STARLIGHT ARCHERY

Warren, MI 48089

2ND LOCATION AT:

Kalamazoo, MI 49002

Phone: 616-327-3285

MINNESOTA

Archery Hut
Robbinsdale, MN 55442

BWANA ARCHERY

St. Paul, MN 55106

MISSOURI

Kansas City Archery Supply
Kansas City, MO 64132

PEMBERTON ARCHERY & SUPPLY

Pacific, MO 63069

MISSISSIPPI

Stinger's Archery Shop
Bay Springs, MS 39422

STRAIGHT-N-ARROWS, INC.

Brandon, MS 39042

NEBRASKA

Al's Archery Center
Omaha, NB 68108

NEW JERSEY

Butts & Bows
Belleville, NJ 07109

THE SPORTSMAN'S CENTER

Bordentown, NJ 08505



Gordon and Miri Bentley at work in Automatic Archery Lanes, Madison, Wis.

Hill's Archery Lanes

Keyport, NJ 07735

Mt. Ephraim Archery

Mt. Ephraim, NJ 08059

NEW MEXICO

4 Corners Archery & Fishing
Farmington, NM 87401

NEW YORK

Lemme's Archery Shop
Albany, NY 12210

Menands Archery Den

Albany, NY 12204

Lou's Archery Center

Bainbridge, NY 13733

Baker Sales & Service

Barneveld, NY 13304

Ed Hart's Gun Supply

Bath, NY 14810

Wildwood Archery Lanes

Memphis, NY 13112

Dave's Bowhunting

Niagara Falls, NY 14302

Solvoy Home and

Outdoor Center
Solvoy, NY 13209

NORTH CAROLINA

Franklin Gun & Rod, Inc.
Asheville, NC 28806

Barefoot Archery

Charlotte, NC 28208

Campbell Archery Sales

N. Wilkesboro, NC 28659

The Sport Shop

Grifton, NC 28530

NORTH DAKOTA

G & G Sporting Goods
Grand Fork, ND 58201

OHIO

John's Sporting Goods
Canton, OH 44706

Flying Feathers Arrows

Fulton, OH 43321

Reiff Sporting Goods

Lima, OH 45801

Primitive Weapons Arena

Milford, OH 45150

Sports Fame, Inc.

Toledo, OH 43623

The Tackle Box

Toledo, OH 43612

Portage Archery

Suffield, OH 44260

Victor Berger

Springfield, OH 45504

Xenia Archery Center

Xenia, OH 45385

OKLAHOMA

Pat's Archery
Okmulgee, OK 74447

Gourley Archery

Sapulpa, OK 74066

OREGON

Oregon Archery
Clackamas, OR 97015

PENNSYLVANIA

Brady's Sport Shop
Millersburg, PA 17061

South East Archery

Glendendon, PA 18036

Faline Archery

Greensburg, PA 15601

Weaknecht Archery

Kutztown, PA 19530

Bucks & Bows Archery Lanes

Pittsburg, PA 15215

Trojan Archery Shop

Waynesboro, PA 17268

Deer Creek Archery

Hadley, PA 16130

SOUTH DAKOTA

Bledsoes Archery Den
Sioux Falls, SD 57103

TENNESSEE

Sportsman's Tackle
Chattanooga, TN 37416

Mahoney's Paradise, Inc.

Johnson City, TN 37601

East Tennessee Outdoor, Inc.

Morrisstown, TN 37814

Bill Dyer Supply Co., Inc.

Paris, TN 38242

TEXAS

Bellows Archery
Dallas, TX 75211

Trophy Archery

Fort Worth, TX 76110

Archery Sports Company

Pasadena, TX 77506

Archery Unlimited

Lubbock, TX 79413

Sportsman's Den

Bryan, TX 77801

Southwestern Bowhunters

Houston, TX 77090

UTAH

Consolidated Field Sports
Salt Lake City, UT 84115

VERMONT

Bill's Wholesale Spig. Goods
Bennington, VT 05201

VIRGINIA

Ammadale Sport & Hobby
Ammadale, VA 22003

Field & Stream Shoppe

Richmond, VA 23225

Shambin Hardware

Richlands, VA 24641

VA Guns & Archery, Inc.

Staunton, VA 24401

Cox Archery Company

Chilhowie, VA 24319

WASHINGTON

Northwest Archery
Seattle, WA 98148

WEST VIRGINIA

Bowhunters Supply
Parkersburg, WV 26101

Mac & Dave's

Huntington, WV 25722

WISCONSIN

Automatic Archery Lanes
Madison, WI 53713

Midway Archery Lanes

Menasha, WI 54952

West Town Archery

Milwaukee, WI 53213

Wally's Shooters Supply

Minacqua, WI 54548

Bob's Archery Lanes

LaCross, WI 54601

The Tackle Box

Wausau, WI 54401

WYOMING

Dean's Sporting Center
Casper, WY 82601

Butler's Archery

Evanston, WY 82930



Bear Compound bows allow you to hold longer at full draw, for the best shot and to shoot for an extended period of time with less muscle fatigue. This is true because, unlike the conventional bow which increases in weight as you draw back the string, the Compound bow reaches it's heaviest draw, or *peak weight*, shortly after you start to pull back the string and then relaxes to much lighter weight to hold at full draw.

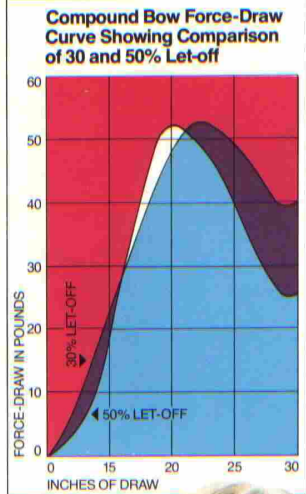
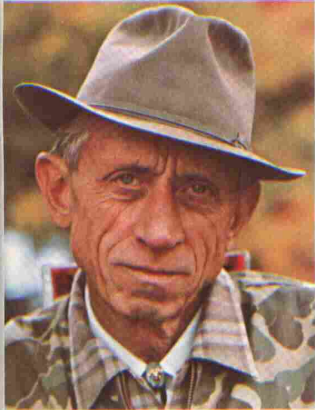

The difference between peak weight of a Compound and the lower weight you hold at full draw, called *relaxed weight*, is a function of the eccentric wheels. Bear uses wheels designed to provide let-off of approximately 30 or 50% less than peak weight. Bows with a smaller degree of let-off store more energy than identical bows with a larger percent of let-off—at the expense of your having to hold more weight at full draw.

Therefore, Bear offers you bow choices—30% let-off for an extra few feet per second in arrow travel or 50% let-off for ease of holding at full draw for a longer period of time.

Bear Compounds come in two and six wheel styles. The two wheeler is the simplest design and requires no tuning or adjustment from the user. The Bear Kodiak Special® and the Bear Blacktail Hunter™ fit into this category. The six wheel design provides for an almost infinite degree of tuning adjustment for your style of shooting and a greater degree of peak

weight adjustment—up to 25 lbs./ 11.25 kg. In general, they also have slightly faster arrow flight than two wheelers. Bear Tamerlane II's®, Alaskan®, Bear Polar LTD®, Temujin II® and Whitetail Hunter® are all of 6 wheel design.

Bear also offers two choices in limb design—Fiberglass® and laminated. Bear's finest bows feature a laminated limb made of Fiberglass® and hardrock maple for the most effective working limbs yet devised. Our thermal bonded Epoxy Resin Fiberglass® limbs are the best in the industry—smooth, fast and long lasting. The choice is yours, and you can't go wrong either way.

All Bear Compounds feature magnesium alloy handles for strength, centralized mass and durability. Many other materials have been tried, but none have matched the all-around durability of the magnesium handle.

The entire design of Fred Bear's Compounds has been carefully engineered and only the best materials are used. Our cables are plastic coated steel aircraft cables and the eccentric wheels on our finest Compounds feature needle roller bearings like those used on automobiles. Our bows are designed to shoot for years. And our Research & Development staff is constantly at work testing and improving our products.

So carefully look over the bows on the following pages and see your local Bear Archery dealer for his aid in helping you choose the bow that is just right for the type of archery you want to do.





BEAR TAMERLANE II™

Catalog Number 4100 (56"/142 cm.)
Catalog Number 4000 (50"/127 cm.)

"The most desired Compound bow on the tournament line today"

- Automatic Fine Tuners—for ease of tuning and smoother let-off
- Infinite tuning adjustments—custom tune to your specifications
- Available in your choice of draw weights and lengths

Standard equipment: Dual needle bearing eccentric wheels, chrome plated idler pulley assembly, weight adjustment assembly, AFT's and micrometer click adjustment assemblies. Springy rest, cover plate for bowsight, lightweight magnesium handle with new handle grip. Converta-accessory insert and Universal Temper Strand bowstring. 56"/142.24 cm. Tamerlane II has stabilizer counterweight hole on face of bow.

Accessory equipment: Bear Easton X-7 Professional arrows, Super Berger button, Killian Chek-It bowsight, Bear Weatherest®, Match 1 arrow rest, new medium and high handle grip, Bear-Easton chrome stabilizer, Omni-Coupler stabilizer, Bear Hunting Stabilizer (to use as a counterbalance), Bear Converta-Bowling, Bear tools, Bear Hot Shot release, Bear-Kalispel Compound bowcase, Bear Assembled Compound bowcase and eccentric wheels—9 sizes for draw lengths from 25 to 34½" (63.50 to 87.63 cm.) on 56"/142 cm. Tamerlane and from 25 to 33¼" (63.50 to 85.09 cm.) on 50"/127 cm. Tamerlane.

Glass color: White

Handle color: "Glacier Vein" Metallic Epoxy

Let-off: 33 to 36% depending on eccentric wheel size

AMO length: 56" (142.24 cm.) or 50" (127 cm.)

Compound bowstring length: 50" (127 cm.) or 44" (111.76 cm.)

Draw weight: Stocked in 30 to 55 lbs. (13.50 to 24.75 kg.). Adjustable downwards over a 10 pound range.

Draw length: 56" (142.24 cm.) Tamerlane II is stocked in 27 to 31" (68.58 to 78.74 cm.) maximum draw lengths in 1" (2.54 cm.) increments. The 50" (127 cm.) Tamerlane II is stocked in 25 to 31" (63.50 to 78.74 cm.) maximum draw lengths in 1" (2.54 cm.) increments. Other weights and draw lengths available on special order.

To order specify:

1. Catalog number 4100 or 4000
2. Draw length desired
3. Draw weight desired
4. Right or left hand

The Bear Tamerlane II is licensed under Allen Patent 3,486,495.

Irvine, California—In a special match race, an arrow from Texan David Hughes, bow-raced and beat Gary Deck's 2,500 horsepower AA/Fuel Dragster from 0 to 60 M.P.H. In general, equal weight arrows fly from a Compound bow about 10% faster than from a conventional recurve bow of the same weight. The Compound's primary advantage is the lower weight at full draw, allowing you to hold longer to take your best shot.

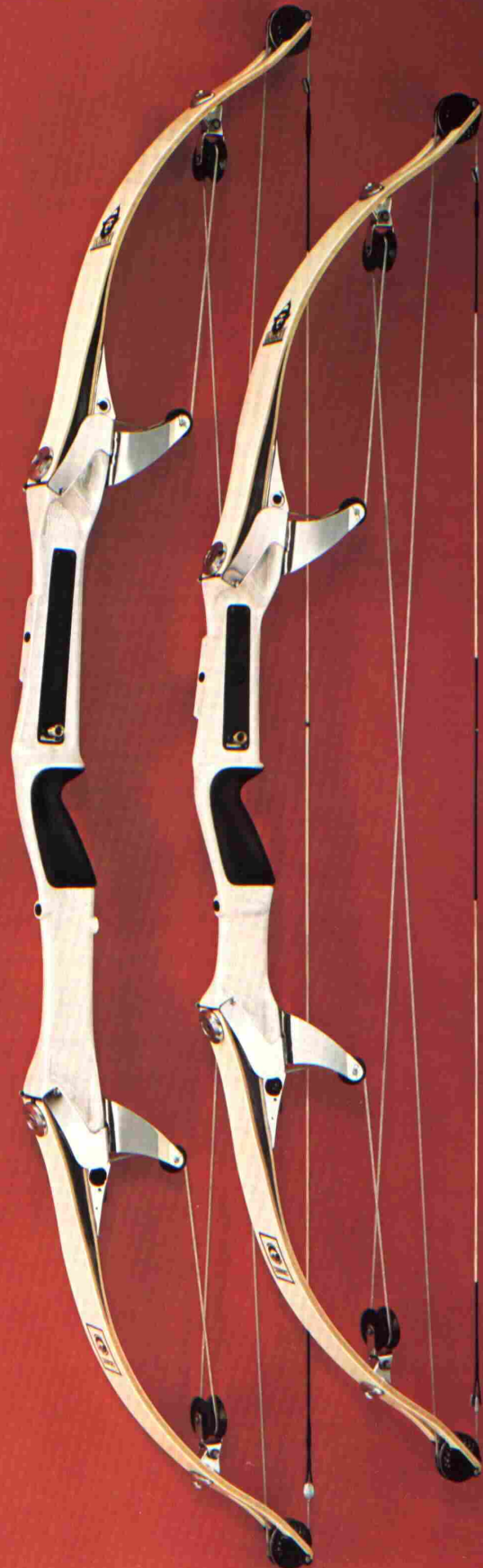



BEAR TEMUJIN II™

Catalog Number 4910 (44"/111.76 cm.)

"Bear's New smooth-shooting tournament bow"

Temujin II features:

- 6-position weight adjustment—change weights to shoot indoors or out
- 30 to 33% let-off eccentric wheels—*with dual needle bearings*
- Available in three draw lengths—pick the one most suitable for you

Standard equipment: Dual needle bearing eccentric wheels, lightweight magnesium handle with Bear Universal Sight Stage, 6-position weight adjustment arms, Bear limb pivot assembly, Bearglas™ and wood laminated limbs, Springy rest, new handle grip, Conventa-accessory insert and Universal Temper strand bowstring.

Accessory equipment: Bear Easton X-7 arrows, Bear-Falcon target arrows, Super Berger button, Killian Chek-It bowsight, Deluxe target and field sight, Bear Weatherest™, Match 1 arrow rest, new medium and high handle grip, Bear-Easton chrome stabilizer, Omni-Coupler stabilizer, Bear Conventa-bowstring, Bear tools, Bear release, Bear Hot Shot release, Bear-Kalispel Compound bowcase, Bear Assembled Compound bowcase and eccentric wheels in 9 sizes for various draw lengths—can be customized at your local Authorized Bear Archery Service Center.

Glass color: White

Handle color: "Glacier Vein" Metallic Epoxy

Let-off: 30 to 33% depending on eccentric wheel size

AMO length: 44" (111.76 cm.) axle to axle, 48" (121.92 cm.) overall

Compound bowstring length: 39" (99.06 cm.)

Draw weights: Adjustable over a 25 lb. (11.25 kg.) range, 35 to 60 lbs. (15.75 to 27 kg.) peak for 32" (81.28 cm.) draw, 30 to 55 lbs. (13.5 to 24.75 kg.) peak for 30" (76.20 cm.) draw and 25 to 50 lbs. (11.25 to 22.5 kg.) peak for 28" (71.12 cm.) draw.

Draw lengths: Stocked in 28" (71.12 cm.) maximum draw, 30" (76.20 cm.) maximum draw and 32" (81.28 cm.) maximum draw.

To order specify:

1. Catalog number 4910
2. Draw length desired
3. Right or left hand

The Bear Temujin II is licensed under Allen Patent 3,486,495.





Salida, Colorado—Ted Grover scans the high plains near his home during a light snowfall. In 1975 Ted was named the Colorado Bowhunter of the Year and was the first person ever to fill a sportsman license in that state using a bow and arrow. A Bear Alaskan has been his constant companion on many hunting trips.

BEAR ALASKAN[™]

Catalog Number 4200 (50"/127 cm.)

"Bear's best—the State of the Art in a Compound Hunting Bow"

Alaskan features:

- 5½" (13.94 cm.) sight window designed for excellent view and proper arrow flight
- Automatic Fine Tuners—for ease of tuning and smoother let-off
- Take-Down Design—small enough to pack in your backpack or suitcase

Standard equipment: Dual needle bearing eccentric wheels, micrometer click adjustment assembly, AFT's, weight adjustment assembly and idler pulley assembly with case hardened and/or stainless steel components in critical assemblies. Long bristle rest, adjustable nylon arrow plate, cover plate for bow sight, lightweight magnesium handle with new handle grip, Converta-Accessory insert and Universal Temper Strand bowstring.

Accessory equipment: Metric Magnum arrows, Metric Hunter arrows, Super Berger Button, Trigger Sight[™], 5" (12.70 cm.) Premier field model hunting sight, Shur-Hit sight, Rain-bow sight, Bear Weatherest[™], Springy rest, Match 1 arrow rest, Bear hunting stabilizer, Converta-bowfishing reel, Fred Bear Kodiak bow quivers, new medium and high handle grips, Bear Converta-bowsling, Bear tools, Compound camo sleeves, Hunter's Compound bowcase, Bear take-down bowcase, Bear assembled Compound bowcase and eccentric wheels—9 sizes for draw lengths from 25" (63.50 cm.) to 34½" (87.63 cm.)

Glass color: Black

Handle color: "Silver Vein" Metallic Epoxy

Let-off: 33 to 36%, depending on eccentric wheel size

AMO length: 50" (127 cm.)

Compound bowstring length: 44" (111.76 cm.)

Draw weight: Stocked in 35 to 70 lbs. (15.75 to 31.50 kg.) peak weights.

Draw length: Stocked in 25 to 33" (63.50 to 83.82 cm.) maximum draw lengths in 1" (2.54 cm.) increments.

To order specify:

1. Catalog number 4200
2. Draw length desired
3. Draw weight desired
4. Right or left hand

Note: Can be ordered with camouflage limbs at no additional charge. The Bear Alaskan is licensed under Allen Patent 3,486,495.



COMPOUND BOW

BEAR POLAR LTD™

Catalog Number 4710 (44"/111.76 cm.)

"The most popular Compound hunting bow sold in the world today"

Bear Polar LTD features:

- 6 Adjustable peak weight settings—use your bow over a range of 25 pounds
- Bow stays in tune throughout entire weight adjustment sequence
- Bearglas and hardrock maple laminated limbs

Standard equipment: Lightweight magnesium handle with Bear universal sight stage, 6-position weight adjustment arms plus platform, Bear limb base pivot assembly, lightweight suspension system, Weatherest®, new handle grip, Converta-accessory insert and Universal Temper Strand bowstring.

Accessory equipment: Metric Magnum arrows, Metric Hunter arrows, Super Berger Button, Bear Converta-bowling, Bear hunting stabilizer, Converta-bowfishing rigs, Fred Bear Kodiak bow quivers, Trigger Sight™, Shur-Hit sight, Rain-bow sight, Springy rest, Match 1 arrow rest, Deluxe target and field sight, eccentric wheels with dual needle bearings, Bear-Kalispel Compound bowcase, Bear assembled Compound bowcase, Hunter's Compound camo bowcase, Compound camo sleeves, Bear tools and new medium high grips.

Glass color: Black

Handle color: "Silver Vein" Metallic Epoxy

Let-off: 50%

AMO length: 44" (111.76 cm.) axle to axle, 48" (121.92 cm.) overall

Compound bowstring length: 39" (99.06 cm.)

Draw weights: Adjustable over a 25 lb. (11.25 kg.) range. 45 to 70 lbs. (20.25 to 31.50 kg.) peak for 32" (81.28 cm.) draw, 40 to 65 lbs. (18 to 29.25 kg.) peak for 30" (76.20 kg.) draw and 35 to 60 lbs. (15.75 to 27 kg.) peak for 28" (71.12 cm.) draw.

Draw lengths: Stocked in 28" (71.12 cm.) maximum draw, 30" (76.20 cm.) maximum draw and 32" (76.20 to 81.28 cm.) maximum draw.

To order specify:

1. Catalog number 4710
2. Draw length desired
3. Right or left hand

The Bear Polar LTD is licensed under Allen Patent 3,486,495.

Whittier Narrows, California—Mel Hughes gets a rise out of his companions in the San Gabriel Valley Bowhunters with his flight shooting. One of California's more active bowhunting clubs, they shoot continuously all year round. Of the twenty-six active members nineteen shoot Bear Compounds.

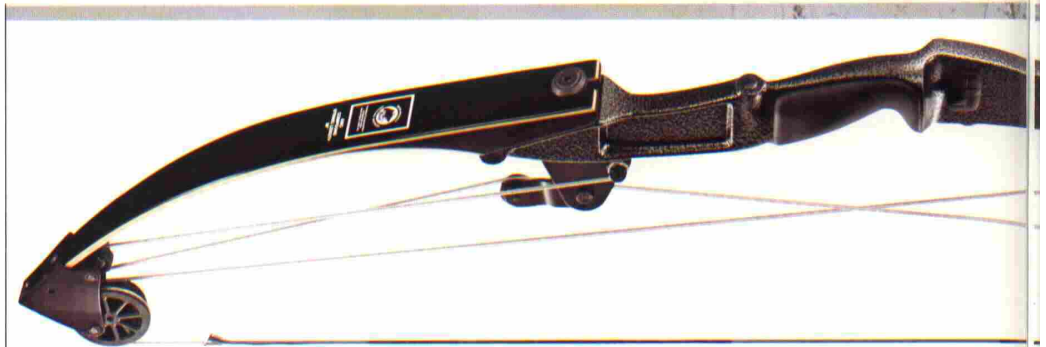



BEAR KODIAK SPECIAL™

Catalog Number 4750 (43"/109.22 cm.)

*"Bear's New 2-Wheeler—
destined to be a favorite"*

Kodiak Special features:

- 2-Wheeler design—factory tuned and set
- 10-pound (4.5 kg.) weight adjustment range
- Laminated limbs—quick and smooth-shooting

Standard equipment: Lightweight magnesium handle with Bear universal sight stage, 10 lb. (4.5 kg.) weight adjustment, Bear limb base pivot assembly, wide offset eccentric wheels, Weatherest®, new pistol handle grip, Converta-accessory insert and Universal Temper Strand bowstring.

Accessory equipment: Metric Magnum arrows, Metric Hunter arrows, Super Berger Button, Bear Converta-Bowsling, Bear hunting stabilizer, Converta-bowfishing rigs, Fred Bear Kodiak bow quivers, Bear Compound bowstringer, Bear-Kalispel Compound bowcase, Bear Assembled Compound bowcase, Hunter's Compound camo bowcase, Compound camo sleeves, Bear tools, Trigger Sight™, Shur-Hit sight, Rain-bow sight, Deluxe target and field sight, Springy rest, Match 1 arrow rest and new medium and high pistol grips.

Glass color: Green

Handle color: "Glade Green" Metallic Epoxy

Let-off: 50%

AMO length: 43" (109.22 cm.) axle to axle, 48½" (123.19 cm.) overall

Compound bowstring length: 37" (93.98 cm.)

Draw weights: Adjustable over a 10 pound (4.5 kg.) range. 55 to 65 lbs. (24.75 to 29.25 kg.) peak for 32" (81.28 cm.) draw, 50 to 60 lbs. (22.5 to 27 kg.) peak for 30" (76.20 cm.) draw and 45 to 55 lbs. (20.25 to 24.75 kg.) peak for 28" (71.12 cm.) draw.

Draw lengths: Stocked in 28" (71.12 cm.) maximum draw, 30" (76.20 cm.) maximum draw and 32" (81.28 cm.) maximum draw.

To order specify:

1. Catalog number 4750
2. Draw length desired
3. Right or left hand

The Bear Kodiak Special is licensed under Allen Patent 3,486,495.



BEAR WHITETAIL HUNTER®

Catalog Number 4500 (44"/111.76 cm.)

"Performance and Economy in a Compound Bow"

Whitetail Hunter features:

- 3-position weight control system—adjustable over 10 pounds (4.5 kg.)
- Power-tapered Bearglas® limbs—smooth, soft and efficient
- New walnut styled Mylar limb finish

Standard equipment: Lightweight magnesium handle with Bear universal sight stage, 3-position weight adjustment arms, double-tapered thermal bonded Bearglas limbs, lightweight eccentric wheels and suspension system, Weatherest®, Converta-accessory insert and Universal Temper Strand bowstring. The Whitetail Hunter has a pre-determined locator for Berger Button and Kilian Chek-It bowsight.

Accessory equipment: Metric Magnum arrows, Metric Hunter arrows, Super Berger Button, Bear Converta-bowstring, Bear hunting stabilizer, Converta-bowfishing rigs, Fred Bear Kodiak bow quivers, Bear Compound bowstringer, Bear Compound cable changer, Bear paw insulated grip, Bear-Kalispel Compound bowcase, Bear Assembled Compound bowcase, Hunter's Compound camo bowcase, Tigger Sight™, Shur-Hit sight, Rain-bow sight, Deluxe target and field sight, dual needle bearing eccentric wheel kit, and 6-position weight adjustment kit.

Limb color: Walnut styled Mylar

Handle color: "Sylvan Brown" Metallic Epoxy

Let-off: 50%

AMO length: 44" (111.76 cm.) axle to axle, 48" (121.92 cm.) overall.

Compound bowstring length: 39" (93.98 cm.)

Draw weights: Adjustable over a 10 pound (4.5 kg.) range. 60 to 70 lbs. (27 to 31.50 kg.) peak for 32" (81.28 cm.) draw, 55 to 65 lbs. (24.75 to 29.25 kg.) peak for 30" (76.20 cm.) draw and 50 to 60 lbs. (22.5 to 27 kg.) peak for 28" (71.12 cm.) draw.

Draw Lengths: Stocked in 28" (71.12 cm.) maximum draw, 30" (76.20 cm.) maximum draw and 32" (81.28 cm.) maximum draw.

To order specify:

1. Catalog number 4500
2. Draw length desired
3. Right or left hand

The Bear Whitetail Hunter is licensed under Allen Patent 3,486,495.

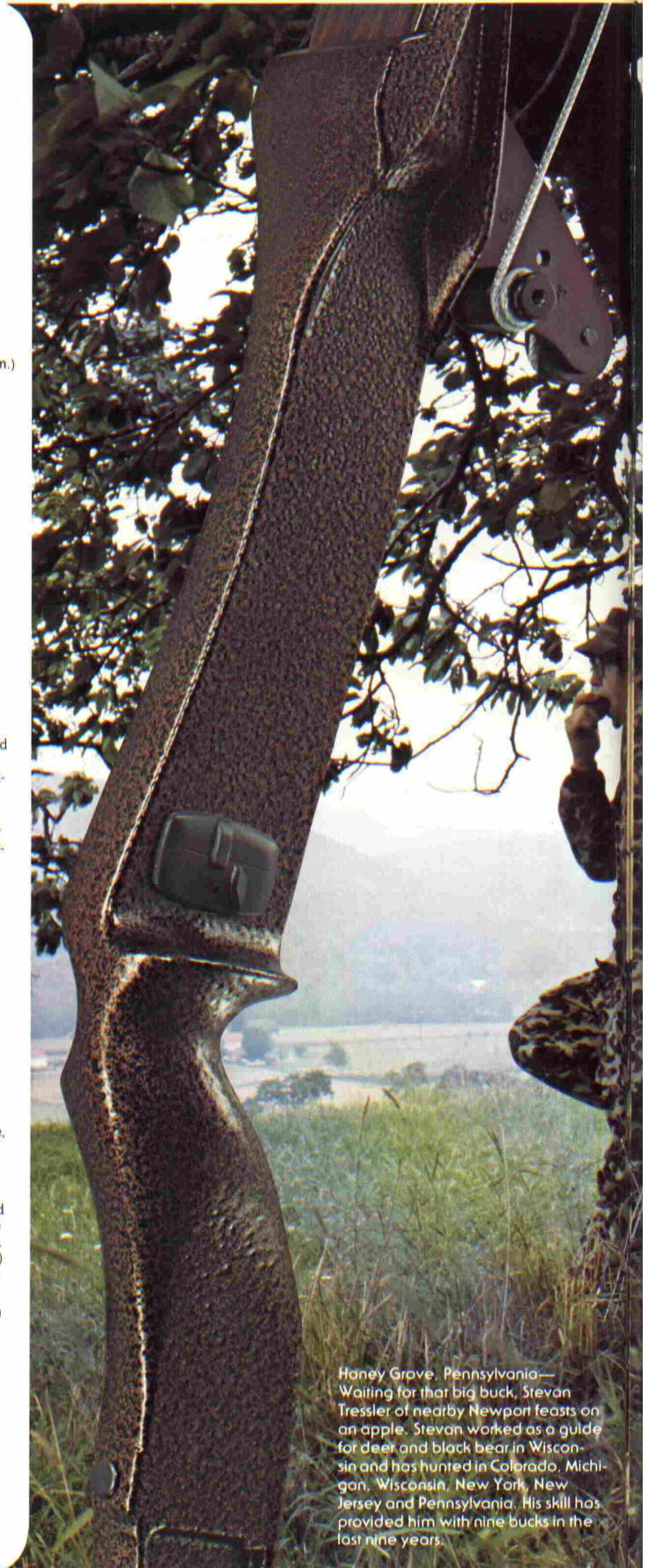

Honey Grove, Pennsylvania—Waiting for that big buck, Stevan Tressler of nearby Newport feasts on an apple. Stevan worked as a guide for deer and black bear in Wisconsin and has hunted in Colorado, Michigan, Wisconsin, New York, New Jersey and Pennsylvania. His skill has provided him with nine bucks in the last nine years.



BEAR BLACKTAIL HUNTER™

Catalog Number 4650 (44"/111.76 cm.)

"The hassle-free Compound with the affordable price"

Blacktail Hunter features:

- Wide eccentric wheels—for good cable clearance and arrow flight
- Factory tuned—no adjustments necessary
- New Mylar limb coating in a Mahogany styled finish

Standard equipment: Lightweight magnesium handle with Bear Universal sight stage, double tapered thermal bonded Bearglas limbs, wide offset eccentric wheels, Weatherest®. Converta-accessory insert and Universal Temper Strand bowstring. The Bear Blacktail Hunter has a predetermined locator for Berger Button and Killian Chek-It bowsight.

Accessory equipment: Metric Magnum arrows, Metric Hunter arrows, Super Berger Button, Bear Converta-bowstring, Bear hunting stabilizer, Converta-bowfishing rigs, Fred Bear Kodiak quiver, Bear Compound bowstringer, Bear Compound cable changer, Bear paw insulated grip, Bear-Kalispel Compound bowcase, Bear Assembled Compound bowcase, Hunter's Compound camo bowcase, Trigger Sight™, Shur-Hit sight, Rain-bow sight and Deluxe target and field sight.

Limb color: Mahogany styled Mylar

Handle color: "Sylvan Brown" Metallic Epoxy

Let-off: 50%

AMO length: 44" (111.76 cm.) axle to axle, 48" (121.92 cm.) overall.

Compound bowstring length: 37" (93.98 cm.)

Draw weights: Peak weight of 50 lbs. (22.50 kg.) on 30" (76.20 cm.)

Draw lengths: Stocked in 30" (76.20 cm.) maximum draw.

To order specify:

1. Catalog number 4650
2. Right or left hand

The Bear Blacktail Hunter is licensed under Allen Patent 3,486,495.



BEAR GRIZZLY[®]

Catalog Number 2161

"An excellent choice for either the experienced or first time bowhunter."

Standard equipment: Weatherest[®], Converta-accessory insert, reinforcing and protective Futurewood[®] overlays on tips, hand-contoured grip, Universal Temper Strand black Dacron[®] bowstring and electrostatically applied Ultra Kote[™] finish.

Accessory equipment: Bear[®] hunting stabilizer, Bear Converta-bow quiver, Bear Converta-bowfishing rigs, Bear Converta-bowsling, Bearhair arrow rest and Silent arrow plate.

AMO length: 58" (142.32 cm.), Hunting length strung 55" (139.70 cm.)

Draw weights: Stocked in 40, 45 and 50 lbs. (18, 20.25, and 22.50 kg.) Special Order Only—35, 55, 60, 65 and 70 lbs. (15.75, 24.75, 27, 29.95 and 31.50 kg.) Weighed at 28" (71.12 cm.) from front of arrow shelf.

Draw length: Unlimited

Glass color: Random dark glass

Handle color: Random color combinations

To order specify:

1. Catalog number 2161
2. Bow weight
3. Right or left hand

Note: Can be ordered camouflage painted at no additional charge.



Fairview, Michigan—As the sun sets over a hunting camp, Fred Bear and Bob Kelly swap bowhunting tales. Scenes similar to this take place all over the U.S. each fall and give bowhunters time to reflect on how good life has been to them. This particular camp was the location for filming "The Good Earth," an outdoor documentary due to be released for television this year.

BEARCAT[®] TAKE-DOWN HUNTER

Catalog Number 2165

"A low-cost take-down hunting bow featuring laminated hardrock maple and Bearglass limbs."

Standard equipment: Weatherest[®], Converta-accessory insert, standard handle Grip, New Bear universal sight platform, drilled and tapped for Kodiak bow quiver.

Accessory equipment: Trigger Sight[™], Shur-Hit Hunting sight, Rain-Bow sight, Deluxe target and field sight, Bear Hunting stabilizer, Bear Converta-bow quiver, Bear Converta-bowfishing rigs, Bear Converta-bowsling, medium and high handle grips, Bearhair arrow rest and Silent arrow plate.

AMO length: 60" (152.40 cm.)

Draw weights: 20, 25, 30, 35, 40, 45, 50 and 55 lbs. (9, 11.25, 13.50, 15.75, 18, 20.25, 22.50 and 24.75 kg.)

Draw length: Unlimited

Glass color: 20 through 35 lbs. (9 kg. through 15.75 kg.)—White Glass laminated composite limbs 40 through 55 lbs. (18 kg. through 24.75 kg.)—Dark Glass laminated composite limbs.

Handle: Space age magnesium

Handle color: "Silver Vein" Metallic Epoxy

To order specify:

1. Catalog number 2165
2. Bow weight
3. Right or left hand

Bearcat[®] Take-Down Limbs Catalog Number 2168

Various weight limbs may be ordered separately, enabling you to have one weight for tournament archery and another for hunting. Available in 15, 20, 25, 30, 35, 40, 45, 50 and 55 lbs. (6.75, 9, 11.25, 13.50, 15.75, 18, 20.25, 22.50 and 24.75 kg.)

Note: Effective draw weight will be two pounds lighter than listed above when used in the 2166 Bearcat Take-Down Handle.

To order specify:

1. Catalog number 2168
2. Whether for use with long or short handle
3. Weight desired.

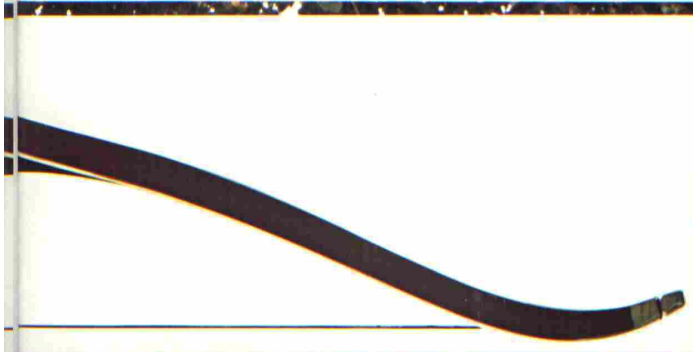
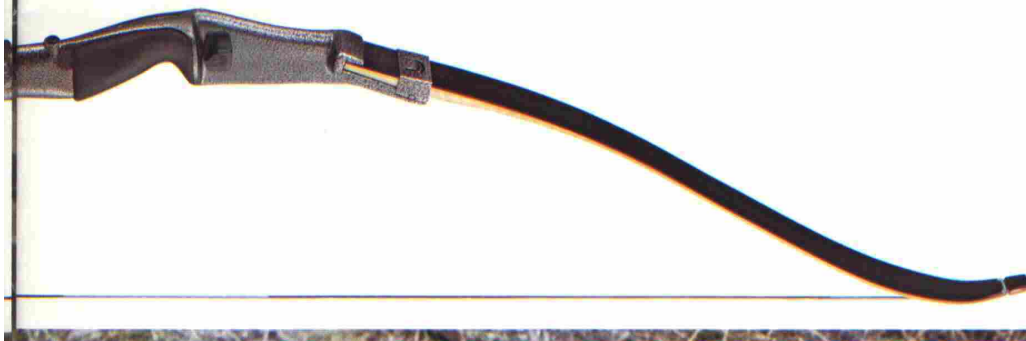



BEAR TIGERCAT™

Catalog Number 2145

"The perfect hunting companion—smooth, quiet and straight shooting."

Standard equipment: Weatherest®, Converta-accessory insert, reinforcing and protective overlays on tips, hand-contoured grip with thumb rest, Universal Temper Strand black Dacron® bowstring and electrostatically applied Ultra Kote™ finish.

Accessory equipment: Bear hunting stabilizer, Bear Converta-bow quiver, Converta-bowfishing rings, Bear Converta-bowsling, Bearhair arrow rest and Silent arrow plate.

AMO length: 56" (142.24 cm.). Hunting length string 52¼" (132.72 cm.)

Draw weights: Stocked in 40, 45, 50 and 55 lbs. (18, 20.25, 22.50 and 24.75 kg.)

Draw length: Unlimited

Glass color: Random dark glass

Handle color: Tundra Gray

To order specify:

1. Catalog number 2145
2. Bow weight
3. Right or left hand

Note: Can be camouflage painted at no additional charge.



Black Bear Hunt Set Catalog Number 2130

58" (147.32 cm.) Black Bear Hunter 45 lbs./20.25 kg.), three 29" (73.66 cm.) matched cedar arrows with Razorheads®, Back quiver, armguard, Bear-Gluv®, Animal target face, ABC's of Archery and Fred Bear's Bowhunting Tips Booklet.

To order specify:

1. Catalog number 2130
2. Right or left hand

Bainbridge, New York—Andrea Slack of nearby Greene gets in some elevated shooting practice before opening day. Andrea is a national caliber trap shooter, races hydroplanes, and is in her second year of fashion design in college. A believer in getting involved in archery, she made her own armguard, glove and fletched and crested her hunting arrows.

BLACK BEAR[™] HUNTER

Catalog Number 2129

"A great all-around bow—use it for bowhunting, bowfishing or field archery."

Standard equipment: Converta-accessory insert, Weatherest[®], Universal Temper Strand black Dacron[®] bowstring and electrostatically applied Ultra Kote[™] finish.

Accessory equipment: Omni-Coupler stabilizer, Hunting stabilizer, Bear Converta-bow quiver, Bear Converta-bowfishing rigs, Bear Converta-bowslings, Bearhair arrow rest and Silent arrow plate.

AMO length: 58" (147.32 cm.), Hunting length strung 55" (139.70 cm.)

Draw weights: 40, 45 and 50 lbs. (18, 20.25 and 22.50 kg.). Weighed at 28" (71.12 cm.) from front of arrow shelf.

Draw length: Unlimited

Glass color: Random dark glass

Handle color: Boreal Brown

To order specify:

1. Catalog number 2129
2. Bow weight
3. Right or left hand

Note: Can be ordered camouflage painted at no additional charge.

BLACK BEAR[™] MAGNUM[™]

Catalog Number 2132

"A 52" hunting bow—perfect for tree stands, ground blinds or heavy cover."

Standard equipment: Converta-accessory insert, Weatherest[®], Universal Temper Strand black Dacron[®] bowstring and electrostatically applied Ultra Kote[™] finish.

Accessory equipment: Hunting stabilizer, Bear Converta-bow quiver, Bear Converta-bowfishing rigs, Converta-bowslings, Bearhair arrow rest and silent arrow plate.

AMO length: 52" (132.08 cm.), Hunting length strung 51" (129.54 cm.)

Draw weights: 40, 45 and 50 lbs. (18, 20.25, and 22.50 kg.). Weighed at 28" (71.12 cm.) from front of arrow shelf.

Draw length: Unlimited

Glass color: Random dark glass

Handle color: Boreal Brown

To order specify:

1. Catalog number 2132
2. Bow weight
3. Right or left hand

Note: Can be ordered camouflage painted at no additional charge.

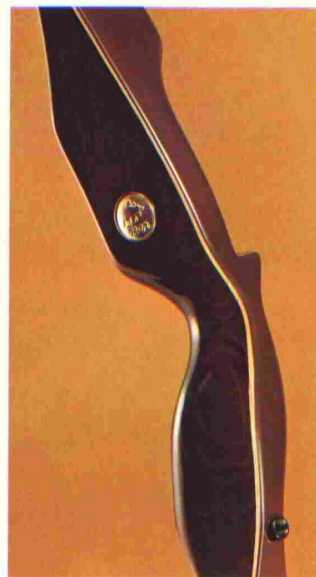
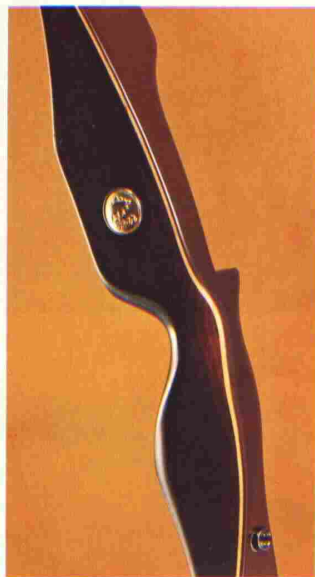

BEAR[®] TAKE-DOWN HUNTER

Catalog Number 2258

"A take-down hunting bow with magnesium handle and interchangeable limbs—all at an economy price."

Standard equipment: Bear universal sight stage, Weatherest[®], Converta-accessory insert, standard handle grip, high impact molded reinforcing and protective overlays on tips and Universal Temper Strand bowstring.

Accessory equipment: Bear hunting stabilizer, Bear Kodiak bow quivers, Converta-bowfishing rigs, Trigger Sight[™], Shur-Hit sight, Deluxe target and field sight, medium and high handle grips, Converta-bowfishing, Bearhair arrow rest and Silent arrow plate.

AMO length: 58" (147.32 cm.)

Draw weights: Light, medium, heavy and extra heavy.

Draw length: Unlimited

Glass color: White on light and medium weight, brown on heavy and extra heavy

Handle: Magnesium

Handle color: "Sylvan Brown" Metallic Epoxy

To order specify:

1. Catalog number 2258
2. Bow weight
3. Right or left hand

Bear Take-Down Hunter Set Catalog Number 2221

"76er Take-Down Hunter Bow with Heavy weight limbs, three cedar Converta-Hunt arrows with Razorheads[®], Bear-Gluv[®], Back Quiver, Armguard, Bowstringer, Handle Grip, Animal Target, Instruction Booklet and Fred Bear's Bowhunting Tips.

To order specify:

1. Catalog number 2221
2. Right or left hand

Bear Take-Down Hunter Limbs Catalog Number 2270

Interchangeable Limbs for Bear Take-Down Hunter Bows.

Buy an extra set of limbs and get more use of your Bear Take-Down. Convert your Target Bow to a Hunting Bow or vice versa. White limbs are available in light & medium. Dark limbs available in heavy & extra heavy.

To order specify:

1. Catalog number 2270
2. Weight desired



OUTFITTING TIPS

The proper match of archery equipment can mean the difference between a discouraged, frustrated shooter and a happy archer. Proper equipment choice is a necessity for good shooting.

If you are just getting started in archery ask for aid in choosing the right equipment. Your local Bear Archery dealer has the experience and interest in getting you started right. Stop by and give him a visit.

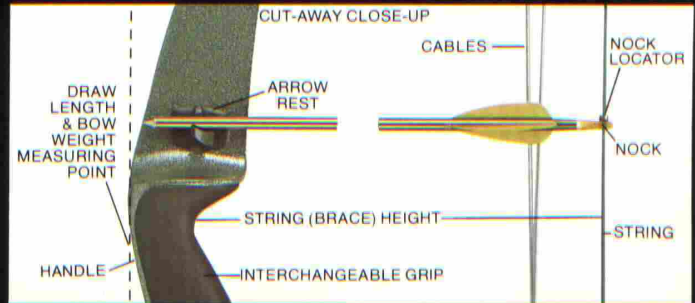

COMPOUND BOW TERMINOLOGY

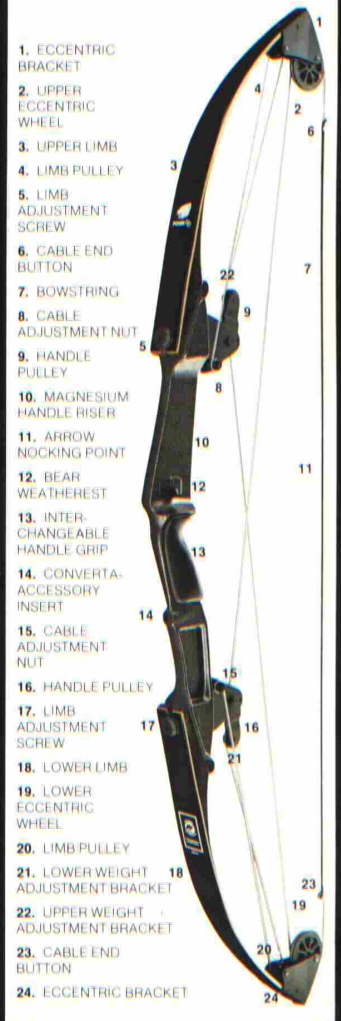

Shreveport, Louisiana—Glen Kelly waits in the southern sun for his first deer. An excellent target archer, Kelly is learning woodlore, tracking and patience in his endeavor to fill the freezer with venison.



Fred dicrates his Field Notes during a recent bear hunt in Saskatchewan.





VICTOR

Long Take-Down Handle
Catalog Number 2180

"This one meets all PAA, NAA and NFAA bow regulations—our finest recurve tournament bow."

Standard equipment: Bristle rest, adjustable nylon arrow plate, sight plate, standard handle grip, chrome yoke and clamp, Converta-accessory insert and three additional stabilizer inserts on face. Will accept Bear Killian Chek-It sight on back or side of bow.

Accessory equipment: Berger Button, magnetic arrow rest, Springy rest, Match 1 arrow rest, Killian Chek-It sight, Bear-Easton chrome stabilizer, Bear hunting stabilizer (used as a counter-balance), Omni-Coupler® stabilizer, medium and high handle grip, Bear release, Bear Hot Shot release, Bear converta-bowling, Bear take-down bowcase and Professional Dacron® bowstring with monofilament serving.

AMO length: 66, 68 and 69" (167.64, 172.75 and 175.26 cm.)

Draw weights: 25 to 50 lbs. (11.25 to 22.50 kg.) Weighed at 28" (71.12 cm.) from front of arrow shelf.

Handle: Space age magnesium

Handle color: "Glacier Vein" Metallic Epoxy

Limb color: White; to order Fascor® limbs, see page 21.

To order specify:

1. Handle section 2180
2. Bow length desired
3. Bow weight desired
4. Right or left hand

VICTOR

Short Take-Down Handle
Catalog Number 2179-308

"The perfect choice for the tournament archer with a shorter draw."

Standard equipment: Bristle rest, adjustable nylon arrow plate, sight plate, standard handle grip, chrome yoke and clamp, and Converta-accessory insert. Will accept Bear Killian Chek-It sight on back or side of bow.

Accessory equipment: Berger Button, magnetic arrow rest, Springy rest, Match 1 arrow rest, Killian Chek-It sight, Bear-Easton chrome stabilizer, Omni-Coupler® stabilizer, medium and high handle grip, Bear release, Bear Hot Shot release, Bear Converta-bowling, Bear take-down bowcase and Professional Dacron® bowstring with monofilament serving.

AMO length: 60, 62 and 64" (152.40, 157.48 and 162.56 cm.)

Draw weights: 25 to 50 lbs. (11.25 to 22.50 kg.) Weighed at 28" (71.12 cm.) from front of arrow shelf.

Handle: Space age magnesium

Handle color: "Glacier Vein" Metallic Epoxy

Limb color: White; order Fascor® limbs separately.

To order specify:

1. Handle section 2179-308
2. Bow length desired
3. Bow weight desired
4. Right or left hand





HOW TO ORDER LIMBS FOR BEAR TAKE-DOWN BOWS

Refer to this chart for the proper match-up of handle section and limbs. To order, please specify the combination Order Number shown in the right hand column. Be sure to mention the bow draw weight you desire along with this Order Number.

Bow Handle	Catalog Number	Length	Limbs	Order Number
Victor long	2180	66" (167.64 cm.)	2107	2180 2107
Victor long	2180	68" (172.72 cm.)	2108	2180 2108
Victor long	2180	70" (175.26 cm.)	2109	2180 2109
Victor short	2179-308	60" (152.40 cm.)	2107	2179-308 2107
Victor short	2179-308	62" (157.48 cm.)	2108	2179-308 2108
Victor short	2179-308	64" (162.56 cm.)	2109	2179-308 2109

Clemson, South Carolina—The Stanislawski family of Portland, Oregon, seems always to be on the move. Mel and Marie both shoot tournament archery as do their six children. Right after this picture was taken at the NFAA National, they packed up their van and drove to Nevada for another shoot and then proceeded to California to do some bowhunting.

BEARCAT[®] TAKE-DOWN

Catalog Number 2166

"A target bow featuring laminated limbs like our finest take-downs, but at a budget price."

Standard equipment: Weatherest[®], Converta-accessory insert, New Bear universal sight stage, handle grip and Universal Temper Strand bowstring.

Accessory equipment: Bear Easton chrome stabilizer, Bear Omni-Coupler[®] stabilizer, Bear hunting stabilizer, Bear Converta-bow quiver, Bear Converta-Bowfishing rigs, Trigger Sight[™], Deluxe target and field sight, Shur-Hit sight, Rainbow sight, medium or high handle grips and Bear Converta-bowsling.

AMO length: 66" (167.64 cm.)

Draw weights: Stocked in 18, 23, 28, 33, 38, 43, 48, and 53 lbs. (8.10, 10.35, 12.60, 14.85, 17.10, 19.35, 21.60 and 23.85 kg.)

Draw length: Unlimited

Glass color: White glass laminated composite limbs, up to 33 lbs. (14.85 kg.) random dark glass laminated composite limbs, 38 to 53 lbs. (17.10 to 23.85 kg.)

Handle: Space age magnesium

Handle color: "Glacier Vein" Metallic Epoxy Finish

To order specify:

1. Catalog number 2166
2. Bow weight
3. Right or left hand

Bearcat[®] Take-Down Limbs Catalog Number 2168

Various weight limbs may be ordered separately, enabling you to have one weight for tournament archery and another for hunting. Available in 15, 20, 25, 30, 35, 40, 45, 50 and 55 lbs. (6.75, 9, 11.25, 13.50, 15.75, 18, 20.25, 22.50 and 24.75 kg.)

Note: Effective draw weight will be two pounds lighter than listed above when used in the 2166 Bearcat Take-Down Handle.

To order specify:

1. Catalog number 2168
2. Whether for use with long or short handle
3. Weight desired.



Madison, Wisconsin—League shooters at The Archery Center take aim during a Fred Bear Sports Club/A.L.O.A. round. The program is designed to provide practice under conditions as close as possible to those encountered in the woods. The Archery Center has over 300 shooters signed up to shoot this 27 session league this fall.

BEAR[®] TARGET TAKE-DOWN

Catalog Number 2264

"A good starter bow for the young archer."

Standard equipment: Bear universal sight stage, Weatherest[®], Converta-accessory insert, handle grip, high impact molded reinforcing and protective overlays on tips and Universal Black Temper Strand Bowstring.

Accessory equipment: Bear Easton chrome stabilizer, Bear Omni-Coupler[®] Stabilizer, Bear Converta-bow quiver, Bear hunting stabilizer, Deluxe target and field sight, Rain-Bow sight, Bear Converta-bowfishing rigs, Silent arrow plate, Bearhair arrow rest, medium and high handle grips and Converta-bowstring.

AMO length: 64" (162.56 cm.)

Draw weights: Light, medium, heavy, and extra heavy. Weighed at 28" (71.12 cm.) from front of arrow shelf.

Draw length: Unlimited

Glass color: White on light and medium weight, brown on heavy and extra heavy.

Handle: Space age magnesium

Handle color: "Glacier Vein" Metallic Epoxy Finish

To order specify:

1. Catalog number 2264
2. Bow length
3. Bow weight
4. Right or left hand



Bear Target Take-Down Set Catalog Number 2222

58" (147.32 cm.) Take-Down Bow with Weatherest[®], Bear Gluv[®], bowsight, instant archery string sight and handle grip. Set also contains three cedar target arrows, bowstringer, armguard, quiver, 16" (40.64 cm.) target and instruction booklet.

To order specify:

1. Catalog number 2222
2. Right or left hand

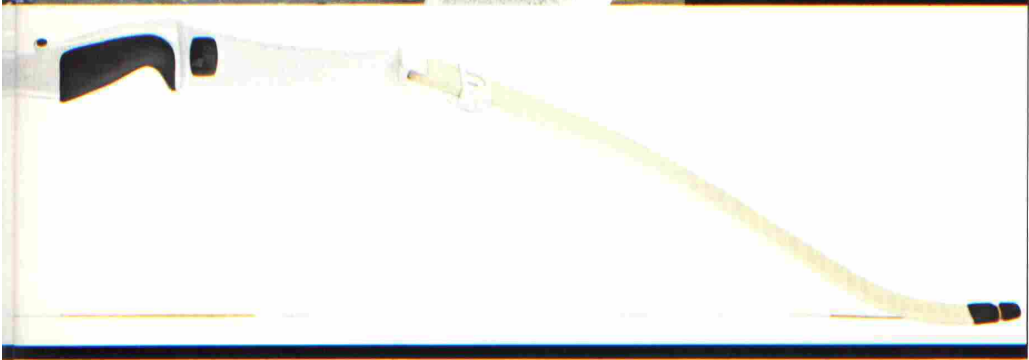
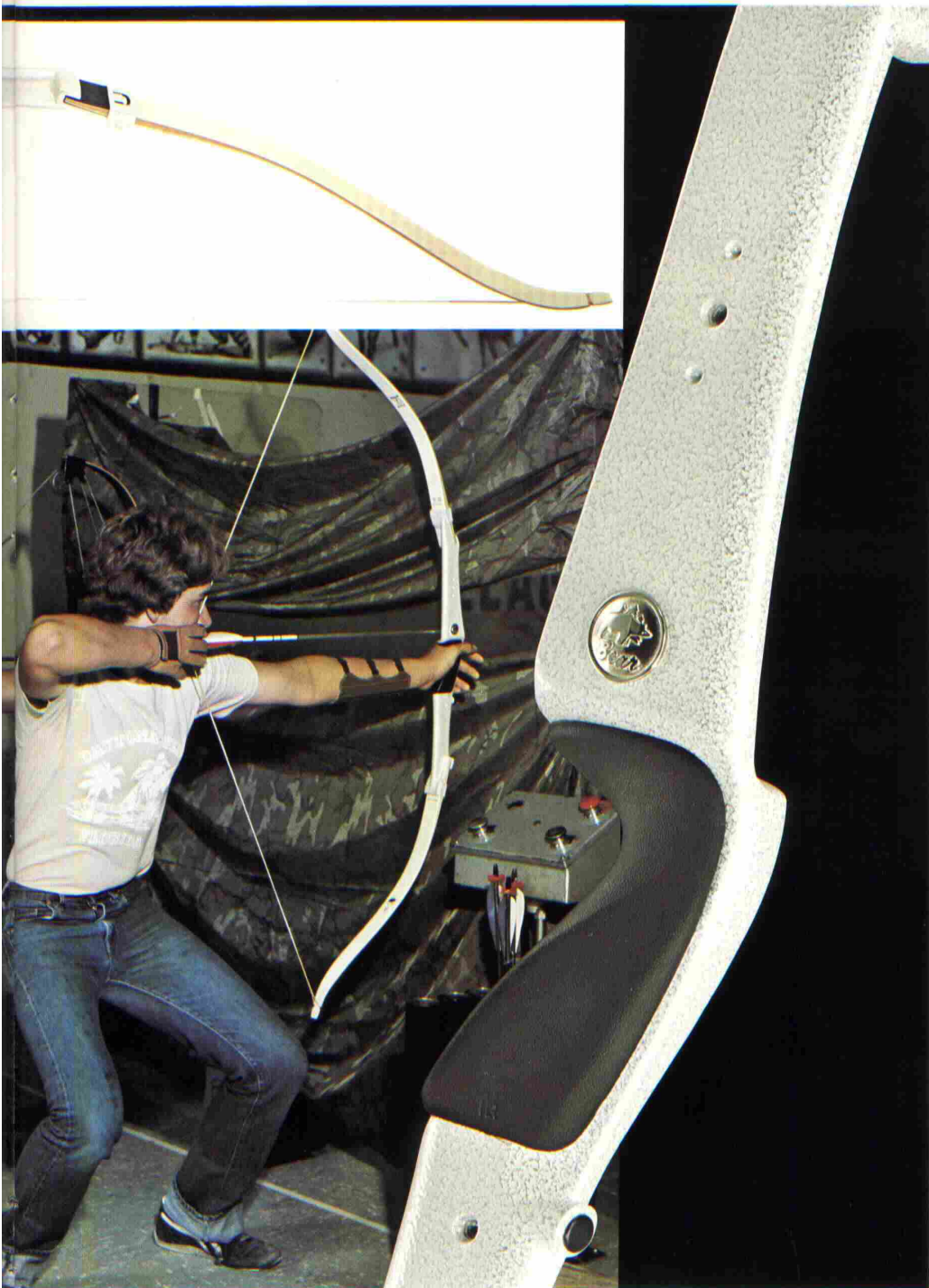

WHITE BEAR™

Catalog Number 2138

"An excellent introduction to the sport of archery."

Standard equipment: Weatherest®, Universal Temper Strand bowstring and electrostatically applied Ultra Kote™ finish.

Accessory equipment: Tape-on bowfishing rig, Bearhair arrow rest and Silent arrow plate, Bear® Bristle rest, Hoyt Pro Rest and Arro-Guide arrow rest.

AMO length: 62" (157.48 cm.)

Draw weights: Stocked in 25/30 and 30/35 lbs. (11.25/13.50 and 13.50/15.75 kg.)

Draw length: Unlimited

Glass color: White

Handle: Selected hardwoods

To order specify:

1. Catalog number 2138
2. Bow weight
3. Right or left hand



Graying Michigan — two 1992 Olympic hopefuls get their archery lessons from their coach and mother. Millions of youngsters take archery instruction in schools, camps and backyards across the United States each year. Archery helps build confidence, eye/hand coordination and teaches self-control and discipline. And it's fun!

45-0028
30R

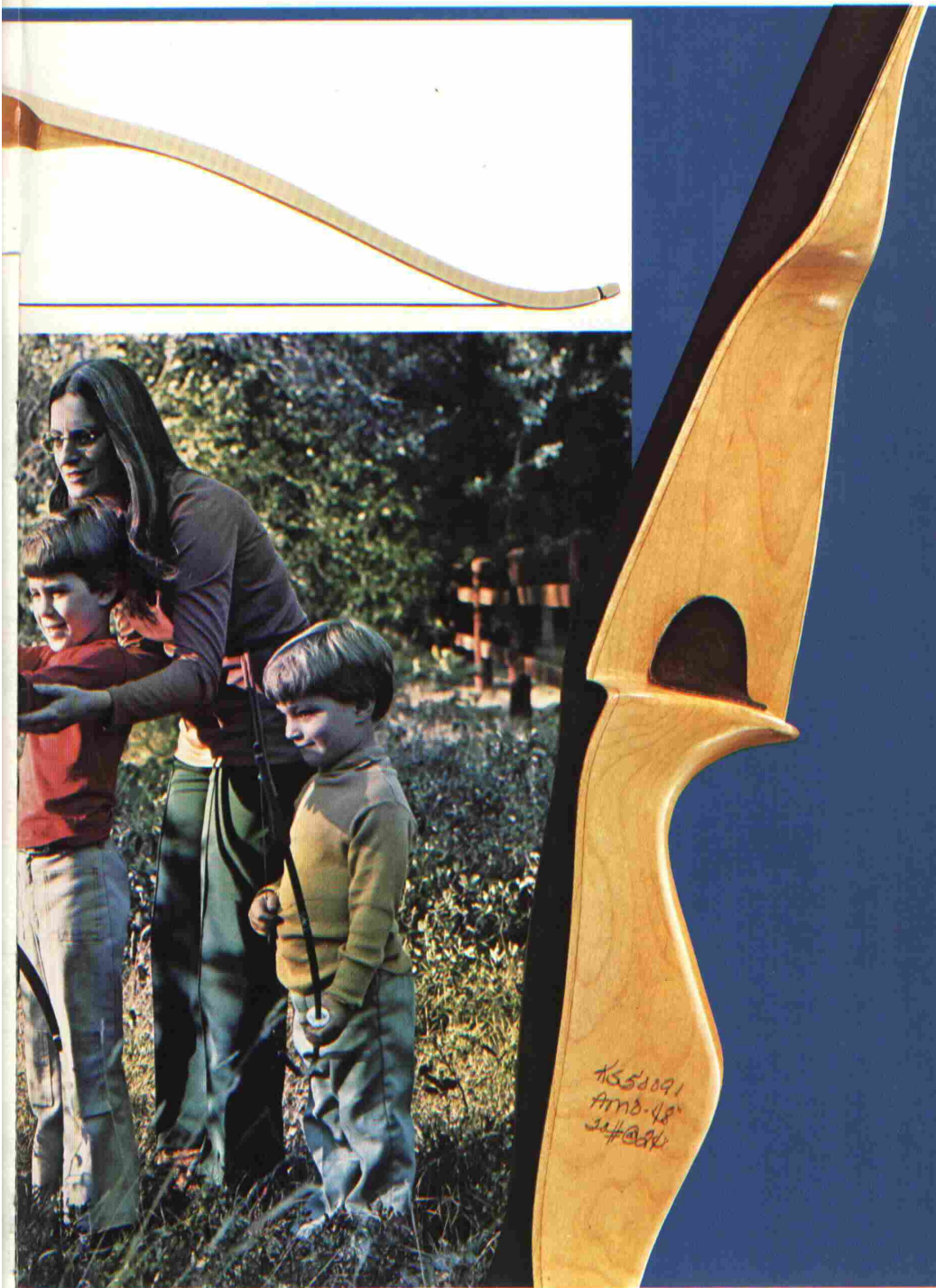

LITTLE BEAR™

Catalog Number 2136

"The perfect choice for the youngster who wants to follow in Dad's footsteps."

AMO length: 48" (121.92 cm.)

Draw weight: 20 lbs. (9 kg.) at 24" (60.96 cm.) draw. Weighed at 24" (60.96 cm.) from front of arrow shelf.

Handle: Hand selected hardwoods.

To order specify:

- 1. Catalog number 2136
- 2. Right or left hand



Little Bear Set Catalog Number 2137

Little Bear Bow (20 lbs./9 kg.), three cedar arrows, Scholar quiver, armguard, Bear-Gluv®, 4-color target and instruction booklet.

To order specify:

- 1. Catalog number 2137
- 2. Right or left hand

All Bearglas® and wood laminated bows are covered by United States patent #2,842,113. Other patents pending.

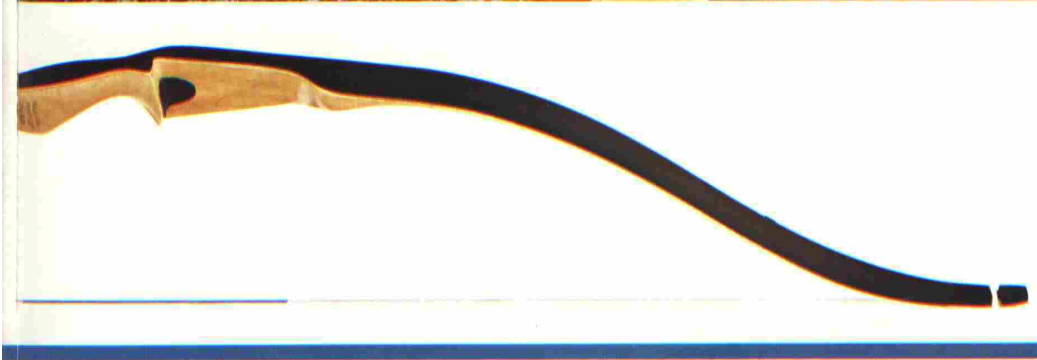

FIBERGLAS SETS



There's a Bear Bow here for everyone. Any age. Boys, girls, men, women. A Fiberglass Bear Bow starts many an archer on his or her way to more fun, to more sport, and even to more sophisticated bows. Start here. For yourself. For the family. For a gift. For target shooting, bowhunting, bowfishing or backyard fun. Each bow shoots left or right handed.

RED BEAR SET

Catalog Number 5506

For older boys and girls. Red Bear 50" (127 cm.) Bow, Bowstring, three 28" (71.12 cm.) cedar arrows with target points, vinyl quiver, target face and instructions. Not a toy.

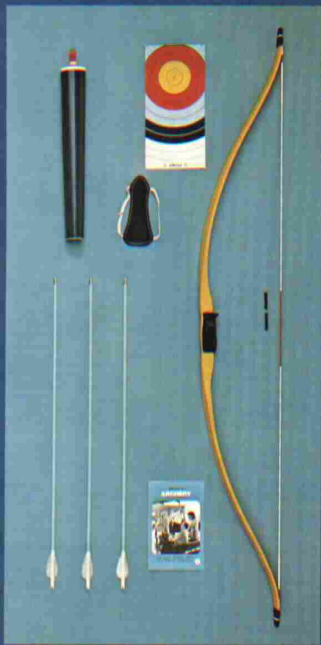

GOLDEN BEAR SET

Catalog Number 5521

Target set. Features 60" (152.40 cm.) recurve Golden Bear bow rated at 30 lbs. (13.50 kg.), with center-served bowstring, three 28" (71.12 cm.) matched cedar target arrows. Belt quiver, armguard, Bear-Gluv. Full-color target. Instruction booklet.

Dealer note: three sets per carton.



Brea, California—Jean Lloyd is an active outdoorswoman, mother, nurse and model. When not working she shoots trap and skeet, target archery, fishes and bowhunts.

BOWFISHING EQUIPMENT

Bowhunting takes on another season with the addition of a Bear Bowfishing Rig. Bowfishing for rough fish in either fresh or salt water is fun and a good way to improve your aim. Carp, Gar, Shark, and many others make for exciting catches. Make this your year to try the challenge of Bow and Arrow Angling.

Bear® Converta-Bowfishing Rig Catalog Number 3005

Almost any Bear bow is ready for fishing whenever you are, with this new reel. It fits right into the accessory insert on all new Bear Compound and Conventional Recurve bows, except White Bear and Little Bear. Complete with reel, 50' (15.24 m.) of 90 lb. (40.50 kg.) test braided nylon line. Fiberglass® arrow with easy-off point, instruction book.

3000 The Bear Converta-Bow-fishing rig with harpoon head.



3010 Tape-on Bowfishing Rig. Tape your rig. Includes reel, 50' (15.24 m.) of 90 lb. (40.50 kg.) test nylon line, Fiberglass arrow with single barb.

3015 Same as 3010. Easy-off point.

3030 Arrow with single barb point.

3035 Arrow with 3060 Easy-off point.

3045 Arrow without point.

3050 Solid Fiberglass shaft only.



3078 Converta Fish reel and line.

3082 Tape-on bracket, reel, line.

3090 Drum for fish reel.

3106 Bracket with screw for 3082.

3110 Extra nylon line, braided, 50' (15.24 m.) of 90 lb. (40.50 kg.) test.

3115 Layfletched, three-vaned, slip-on, plastic fletching for $\frac{9}{32}$ " (3.97 mm.) and $\frac{11}{32}$ " (8.73 mm.) shafts.



3055 Single-barbed harpoon head.

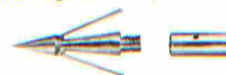

3060 Easy-off fish point, double-barbed harpoon head, screws on.

3065 Extra 3060 head.

3070 Extra 3060 shank.



7905 Al's fish slick retractable point, moving barb loosens fish quickly.

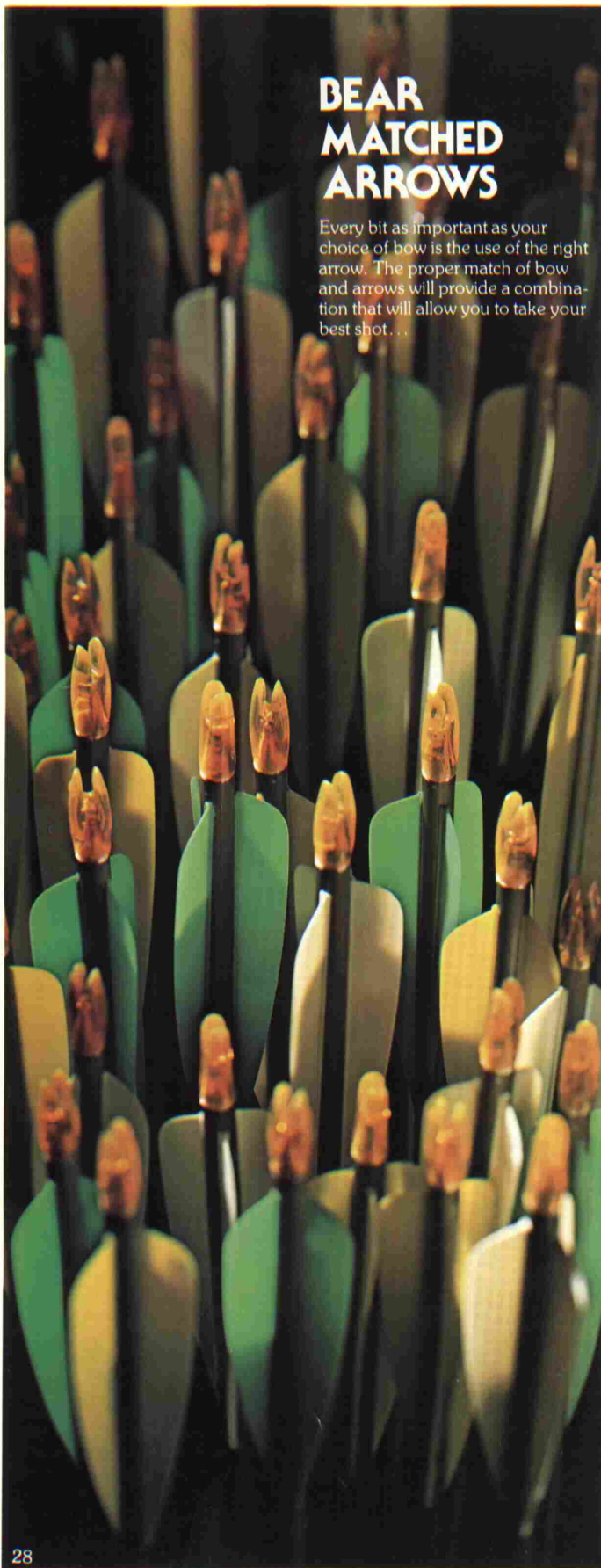

BEAR MATCHED ARROWS

Every bit as important as your choice of bow is the use of the right arrow. The proper match of bow and arrows will provide a combination that will allow you to take your best shot...

Bear sells arrows that are matched in spine and in weight. That means that a package of Bear arrows are arrows extremely closely matched to each other in degree of shaft thickness and overall arrow weight. Our arrows are made of either aluminum, fiberglass or cedar and all of our best arrows feature Weathers™, Bear's exclusive injection molded plastic fletching that is weather-proof, stable and has a rapid recovery rate.

How to select the correct arrow length

Arrow length is marked on each package of arrows and that figure is the length of the arrow measured from the bottom of the nock slot to the back of the head. To find what length arrow you draw, try one of the two methods listed below.



First method. Hold yardstick at center of chest as shown. Your draw is measurement at fingertips.

Second method. Draw a measuring arrow (marked in inches) in your bow. At full draw, your correct arrow length stops at the front of the arrow shelf.

How to match arrows and bow weight on Compound bows

Due to the Compound's release weight, a variety of arrow sizes can be shot out of a Compound. For hunting, Bear recommends that you use your bow's peak weight as the figure with which to match your arrow weight. This weight will provide for the higher degree of energy on delivery. Using peak weight is also a good starting point for target or field shooting, but you may wish to experiment for the perfect spine for your bow, your type of release and your shooting style.

How to match arrows and bow weight on Recurve bows

Match your draw length to your bow weight. For each inch over 28" (71.12 cm.) draw add 2 lbs. (5.08 kg.) to the weight required and for each inch under 28" (71.12 cm.) draw subtract 2 lbs. (5.08 kg.) from the weight required.

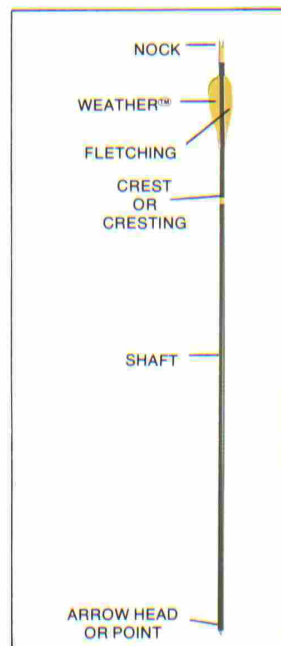

Bear's Converta-Point system

Our finest arrows feature interchangeable points that you can adapt as the situation demands. Practice in the field with blunts or field points and easily change to Super Razorheads for the hunt. Simply screw in the head you need. Blunts and field points are matched to Razorhead weight for best flight. The finest way to go.

For a complete listing of points, see page 38.

THE ALL-NEW BEAR SUPER RAZORHEAD™



Designed by Fred Bear to be the best hunting head available

"The Bear Razorhead is the most widely used hunting head in the world. More game has been taken with it than any other. Yet we felt that there was a need for a head pre-sharpened at the factory. Now we offer the Super Razorhead—a broadhead with all the features of the Razorhead plus more.

The Super Razorhead comes from our factory ready to use, chisel-pointed with edges honed to a razor-like finish. If you prefer this kind of cutting edge use it as it is. If, on the other hand, you want an edge comparable to those used by the butcher or surgeon, several passes with the Cutmaster over the edges of both the main blade and the insert will produce that kind of edge—one that I personally prefer.

The main cutting edges of the Super Razorhead are protected from weather and abrasion by a removable plastic coating. Insert blades are also honed to a fine edge. The Super Razorhead can be resharpened in the field. No extra blades to buy or carry. A few passes with a Bear Cutmaster will quickly bring the edge back.

Design of the Super Razorhead provides for the largest possible cutting surface without wind planing. These heads perform excellently with Weathers™, feathers or vanes and Super Razorheads begin working on impact with no tip to impare penetration. An excellent choice for the experienced bowhunter or for the beginner.

When using the Super Razorhead always use the insert. No hunting arrow with a single blade head should be shot at big game.

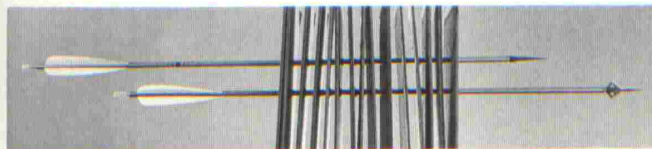

Better penetration is obtained with inserts because it reduces pinch on the shaft.

Experienced bowhunters will not be caught with dull arrows on their bow or in their quiver. We provide Cutmaster for your use resharpening Super Razorheads, but regardless of how you resharpen them—filed, stoned or honed, be sure that they are sharp."

Fred Bear

In the future the Super Razorhead will be the standard against which all other broadheads are measured. They are offered with all Bear Converta-point arrows and are also available in a package of five heads, five inserts and a Cutmaster.

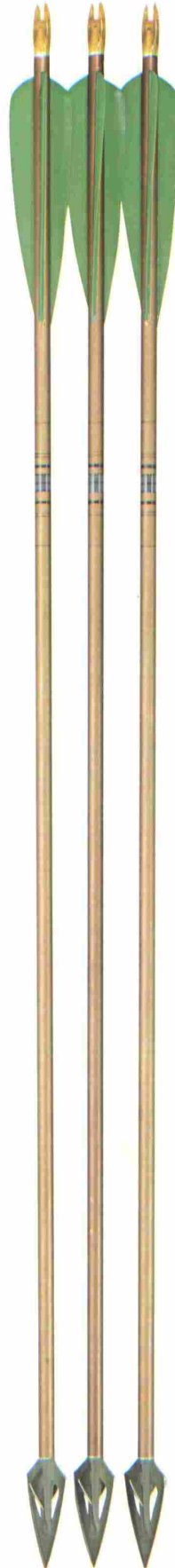

METRIC MAGNUMS™

1654 Series

"Our finest arrows—designed and built for Compound bows"

- X-7 alloy shafts—virtually indestructible
- "Hard Coated" for a longer life—not anodized
- Hand crested—for that extra touch of class

Their name comes from their outside diameter—based on a metric measuring system. They are a Bear exclusive—the first arrow designed for Compound bows and featuring large diameter for increased strength and spine without increased weight. They fly fast, accurately and with the foot pounds of energy necessary in bowhunting. 5" Weathers™ fletching, "Hard Coating" for a durable finish, new Polysulfone Converta-point inserts and hand cresting all add to the magic. Metric Magnums by Bear—the finest hunting arrows available anywhere.

Fred Bear's Metric Magnums are packaged in a set of 8. They are stocked in 30" (76.20 cm.), 31" (78.74 cm.) and full length. Other lengths available on special order. To order, specify bow weight and draw length.

1850 Metric Magnum arrows fitted with high strength inserts (no points).

1851 Full length Metric Magnum arrows with high-strength inserts unattached (no blades).

1852 Metric Magnum arrows with Converta-Field points.

1854 Metric Magnum arrows with Converta-Point four-blade Super Razorheads.

1855 Matched set of Metric Magnum arrows with four four-blade Super Razorheads, four Converta-Field points and four Converta-Blunt points.

Metric Magnum Spine Chart

1654 Series	Shaft size at draw length			
	8.4 mm.	8.5 mm.	8.6 mm.	8.7 mm.
28" (71.12 cm.)	60-70 lbs. (27.31-30 kg.)	70-80 lbs. (31.50-36 kg.)	80-90 lbs. (36.40-5 kg.)	90-100 lbs. (40.5-45 kg.)
29" (73.66 cm.)	50-60 lbs. (22.50-27 kg.)	60-70 lbs. (27.31-30 kg.)	70-80 lbs. (31.50-36 kg.)	80-90 lbs. (36.40-5 kg.)
30" (76.20 cm.)	40-50 lbs. (18.22-22.50 kg.)	50-60 lbs. (22.50-27 kg.)	60-70 lbs. (27.31-30 kg.)	70-80 lbs. (31.50-36 kg.)
31" (78.74 cm.)	30-40 lbs. (13.50-18 kg.)	40-50 lbs. (18.22-22.50 kg.)	50-60 lbs. (22.50-27 kg.)	60-70 lbs. (27.31-30 kg.)
32" (81.28 cm.)	20-30 lbs. (9.13-13.50 kg.)	30-40 lbs. (13.50-18 kg.)	40-50 lbs. (18.22-22.50 kg.)	50-60 lbs. (22.50-27 kg.)

METRIC HUNTERS™

1914 Series

"Bear's New aluminum hunting arrow—designed for performance and economy"

- 24SRT-X alloy shafts—durable and uniform
- Anodized—for beauty and corrosion resistance
- Converta-point design—interchangeable heads for field shooting, small or large game

Metric Hunters are an economical answer to the high cost of aluminum hunting arrows. Designed like the Metric Magnum for Compound bows, they feature large metric diameters for increased spine without excess weight. They have Weathers™ fletch, are anodized for corrosion resistance and have Polysulfone Converta-point inserts. Make them your first choice for practice or utility hunting arrows. Metric Hunters offer quality and uniformity at a price you can afford. Packaged in a set of 8, they are stocked in 30" (76.20 cm.), 31" (78.74 cm.) and full length. Other lengths available on special order. To order, specify bow weight and draw length.

1910 Metric Hunter arrows fitted with high strength inserts (no points).

1911 Full length Metric Hunter arrows with high-strength inserts unattached (no points).

1912 Metric Hunter arrows with Converta-Field points.

1914 Metric Hunter arrows with Converta-point four-blade Super Razorheads®.

1915 Matched set of Metric Magnum arrows with four four-blade Super Razorheads®, four Converta-Field points and four Converta-Blunt points.

Metric Hunter Spine Chart

1914 Series	Shaft size at draw length	
	8.5 mm	8.5 mm
28" (71.12 cm.)	70-80 lbs. (31.50-36 kg.)	80-90 lbs. (36-40.5 kg.)
29" (73.66 cm.)	60-70 lbs. (27.23-31.8 kg.)	70-80 lbs. (31.80-36 kg.)
30" (76.20 cm.)	50-60 lbs. (22.50-27 kg.)	60-70 lbs. (27.31-31.5 kg.)
31" (78.74 cm.)	40-50 lbs. (18.22-22.5 kg.)	50-60 lbs. (22.50-27 kg.)
32" (81.28 cm.)	30-40 lbs. (13.50-18 kg.)	40-50 lbs. (18.22-22.5 kg.)

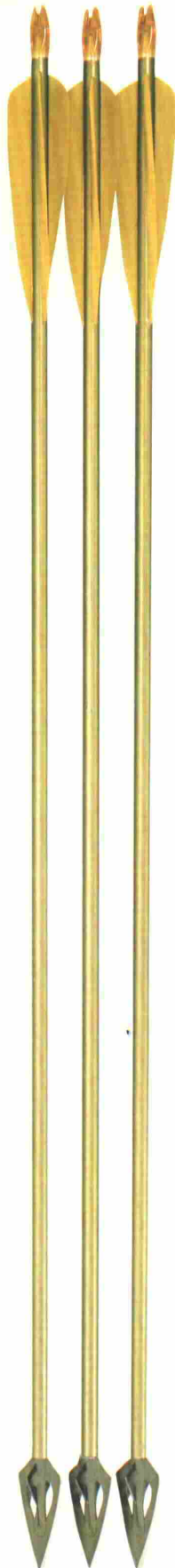

KODIAK® CONVERTA-POINT™

1894 Series

"Moisture and temperature resistant—Fiberglas is a good choice"

- Good concentricity and straightness
- With Tuff-Tips for added strength
- Interchangeable heads—for the type of archery you do

Kodiak fiberglas arrows are good for hunting or practice. Their Converta-point interchangeable head system lets you choose Super Razorheads®, blunt or field points as are called for. Bowhunters like the all-weather qualities of both the shafts and the 5" Weathers™ fletching. Kodiak Converta-points are packaged in a set of 8. They are stocked in 30" (76.20 cm.), 31" (78.74 cm.) and full length. Other lengths available on special order.

To order, specify bow weight and draw length.

1890 Kodiak arrows fitted with high-strength inserts (no points).

1891 Full-length Kodiak arrows with high-strength inserts unattached (no points).

1892 Kodiak arrows with Converta-Field points.

1894 Kodiak arrows with Converta-Field four-blade Razorheads.

1895 Matched set of Kodiak arrows with four four-blade Super Razorheads®, four Converta-Field points and four Converta-Blunt Points.

Kodiak Converta-Point Spine Chart

1894 Series	Shaft size at draw length			
	7	8	9	10
28" (71.66 cm.)	up to 40 lbs. (18 kg.)	40-50 lbs. (18.22-22.5 kg.)	50-60 lbs. (22.50-27 kg.)	60-70 lbs. (27.31-31.5 kg.)
30" (76.20 cm.)	up to 40 lbs. (18 kg.)	40-50 lbs. (18.22-22.5 kg.)	50-60 lbs. (22.50-27 kg.)	
31" (78.74 cm.)	up to 40 lbs. (18 kg.)	40-50 lbs. (18.22-22.5 kg.)	50-60 lbs. (22.50-27 kg.)	

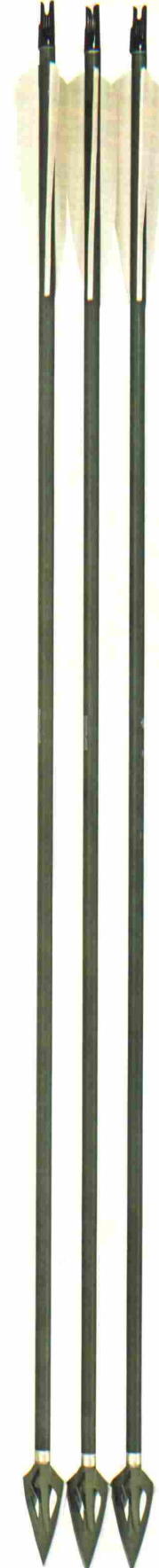

TOP GRADE CEDAR CONVERTA-POINT™

1844 Series

"Interchangeable points add to their usefulness"

- Top Grade Port Orford Cedar
- Spine matched to ± 5 lbs. (2.27 kg.)
- Excellent quality and flight characteristics

Top Grade Cedar Converta-Point arrows are the archer's favorite. They are the closest mass-produced spine matched cedar arrows available. Fitted with 5" (12.70 cm.) Bear Weathers™, they are the perfect choice for either Compound or recurve bows.

Top Grade Cedar Converta-Points are packaged in a set of 8. They are available only in 30" (76.20 cm.), 31" (78.74 cm.) and full length.

Draw weights available are 40/50 lbs. (18/22.50 kg.), 50/60 lbs. (22.50/27 kg.), and 60/70 lbs. (27/31.50 kg.). To order, specify bow weight and draw length.

1840 Cedar Arrows with WACA adapter attached (no points).

1841 Full length cedar arrows with WACA adapters unattached (no points).

1842 Cedar arrows with Converta-Field points.

1844 Cedar arrows with Converta-Point four-blade Super Razorheads®.

1845 Matched set cedar arrows with four four-blade Super Razorheads®, four Converta-Field points and four Converta-Blunt points.



BEAR HIGH GRADE CEDAR

1864 Series

"A good choice for the novice or the expert"

- Colorful cresting on tough cedar shafts
- Spine matched to ± 5 lbs. (2.27 kg.)
- Fletched with Bear Weathers™.

A good choice for either hunting or field shooting. Priced for the beginner, but a good choice for a utility arrow for the more experienced hunter. Can be used with Compound or recurve bows.

Bear High Grade Cedar arrows are packaged 8 to a set. They are available only in 30" (76.20 cm.), 31" (78.74 cm.) or full length. Draw weights available are 30/40 lbs. (13.50/16 kg.), 40/50 lbs. (18/22.50 kg.), 50/60 lbs. (22.50/27 kg.), and 60/70 lbs. (27/31.50 kg.). To order, specify bow weight and draw length.

1861 Cedar Arrows, full length (no points).

1862 Cedar Arrows with field points.

1864 Cedar Arrows with four-blade Razorheads®.

1865 Matched set of Cedar Arrows with four four-blade Razorheads® and four field points.

CEDAR FLU-FLU'S

1849 Series

"Limited action for bird, small game or trap"

- Fast flight with limited distance
- For Compound or recurve bows
- Interchangeable heads

Smart feather design provides fast flight at release, then slows to arc to limit distance. Available in 30" length (76.20 cm.) and weights from 40 to 70 lbs. (18 to 31.50 kg.) in 10 lbs. (5.54 cm.) spine weight tolerance. Cedar Flu-Flu's are packaged 4 to a set.

1847 Cedar Flu-Flu arrows with Converta-Blunt points.

1848 Cedar Flu-Flu arrows with Converta-Field points.

1849 Cedar Flu-Flu arrows with Converta-Point four-blade Super Razorheads®.



BEAR EASTON PROFESSIONAL X-7 TOURNAMENT ARROWS

1810 Series

"Preferred by top tournament archers"

- X-7 alloy—used by the world's top shooters
- Tubing manufactured to exacting tolerances
- Meadow green color with hand crestring

The finest aluminum tournament arrows available. Multi-color hand crestring, helical fletched Weathers™ and the finest tubing available. Bear Easton X-7 Tournament arrows are able to match up to your best performance.

Available in sizes 1516, 1614, 1616, 1714, 1716, 1814, 1816, 1914, 2014. Bjorn nocks. Specify shaft size and length or specify bow weight and draw length and we will select proper shaft size. Packaged in sets of 8.

1810 Cut to length, fitted with insert target points.

1811 Full length with target points unattached.

Bear Easton Component Parts

1305 Full length shafts with points unattached. Dozen pack.

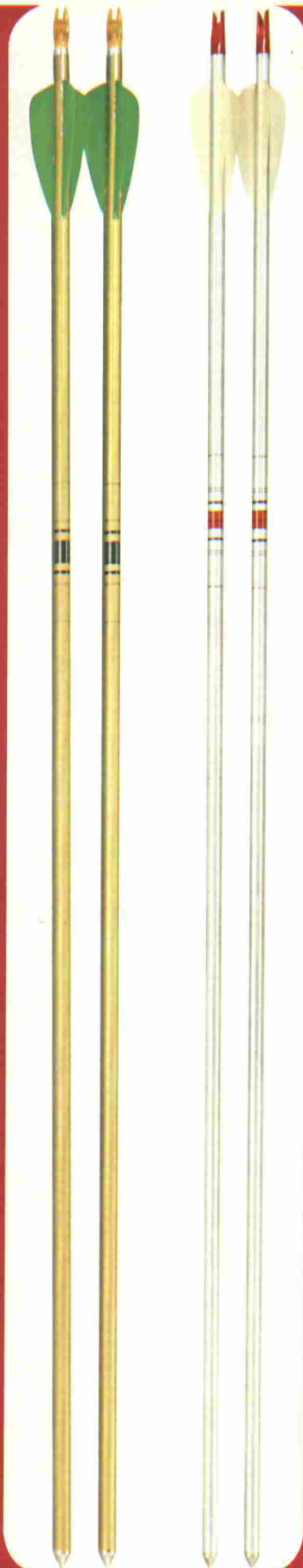

BEAR FALCON® ALUMINUM TARGET ARROWS

1800 Series

"An economical alternative in tournament arrows"

- 24 SRT-X alloy for precision tolerances
- Multi-color hand crestring
- Carefully matched weight and spine

Bear Falcon target arrows are a good choice. They are excellent as economical arrows for the beginning tournament archer and the perfect practice and utility arrow for the expert. Hand crestring and fletched with matched Weathers, they are available in the following sizes and lengths only. Packaged in sets of 8.

Size 1616 20/30 lbs. (9/13.50 kg.) 27" (68.58 cm.) or full length.

Size 1716 30/35 lbs. (13.50/15.57 kg.) 28" (71.12 cm.) or full length.

Size 1816 35/40 lbs. (15.75/18 kg.) 28" (71.12 cm.) or full length.

Size 1916 35/45 lbs. (15.75/20.25 kg.) 29" (73.66 cm.) or full length.

Size 2016 35/45 lbs. (15.75/20.25 kg.) 30" (76.20 cm.) or full length.

1800 Cut to length, target points installed as indicated by sizes above.

1801 Full length with target points unattached.

BEAR KODIAK® TARGET ARROWS

1825 Series

"Moisture resistant fiberglass® for long life"

- All-weather arrows that scorn moisture
- Good concentricity and straightness
- Not bothered by temperature change

Bear Kodiak target arrows are rugged and lightweight. Fletched with Bear Weathers™, they are available in three different sizes—No. 2, No. 4 and No. 6. Specify bow weight and draw length. Stocked in 27, 28, 29 (68.58, 71.12, 73.66 cm.) and full length. Packaged in sets of 8.

1825 Cut to length with insert target points.

BEAR HIGH GRADE CEDAR

1860 Series

"A good choice for the beginner"

- Colorful cresting on tough cedar shafts
- Spine matched to 5 lbs. (2.27 kg.)
- Fletched with Bear Weathers™

A tough Port Orford cedar arrow that can be used with Compound or recurve bows. Available in the following sizes only. Please specify bow weight and draw length. Packaged in sets of 8.

1860 Target arrows in these sizes and weights:
 26" (66.04 cm.)—30/40 lbs. (13.50/18 kg.)
 28" (71.12 cm.)—30/40 lbs. (13.50/18 kg.) and 40/50 lbs. (18/22.50 kg.)
 30" (76.20 cm.)—40/50 lbs. (18/22.50 kg.) and 50/60 lbs. (22.50/27 kg.)

STANDARD GRADE MATCHED CEDAR ARROWS

1882 Series

"Just right for the New archer"

- Port Orford cedar
- Non-skid field point
- Fletched with Bear Weathers™

Economical quality cedar arrows for beginners in weights of 40/50 lbs. (18/27.50 kg.) and 50/60 lbs. (22.50/27 kg.). Assorted color shafts, 29" (73.66 cm.) only. Specify bow weight. Packaged in sets of 8.

1882 Cedar arrows, cut to 29" (73.66 cm.)

INEXPENSIVE CEDAR ARROWS

1230 Series

"For your favorite young archer"

- Port Orford cedar
- Plastic nock and feather combination
- Economical price

Priced right for the beginner. Durable and useful. 28" (71.12 cm.) only, not recommended for bows over 40 lbs. (18 kg.). Packaged 72 to a box.

1230 Cut to length, target points installed.

BEAR QUIVERS

The addition of a quiver to your archery tackle allows you to keep your arrows close at hand for use and, at the same time, helps protect them from wear and tear. Choose a quiver for the type of archery you do. Either a belt quiver for target and field shooting or a belt quiver or one of the very popular bow quivers for hunting.



3735 Tournament Belt Quiver
Looks good on the line. It's in smart black vinyl, scuff-resistant, holds 12 arrows, includes divider, belthook, ring, and a generous zipper pocket for your day's shooting needs. Specify right or left hand.

3736 National Belt Quiver
In random vinyl colors. Holds 12 arrows. Includes divider strap, belt hook, ring, and open accessory pocket. Specify right or left hand.



3250 Mohican Belt Quiver
Low cost, yet of durable vinyl. Contrasting vinyl cuff. Tote 8 to 10 arrows. Includes belt hook and ring. Random colors.

3255 Scholar Belt Quiver
Holds four to six arrows. Handy belt loop. Random vinyl colors.



Quality Bear® Belt
Complement your Bear accessories. Cut to your size. Distinctive Bear medallion on gleaming buckle face.

3275 black lizard, 1½" wide (3.81 cm.)

3280 buckle only, 1½" (3.81 cm.)



3592 Fred Bear® Eight-Arrow Converta-Bow Quiver
Fits Bear Compounds, Take-Downs and Bear laminated bows with a stabilizer bushing. Simple attachment comes with Bowquiver Adapter Kit. Will fit most other make bows 48" — 70" (121.92 — 177.80 cm.) equipped with a stabilizer bushing. Holds eight arrows. Comes complete with instructions. Specify right or left hand.

Safety note: All Bear Bow Quivers share an important benefit; hunting points are held securely in a protective shield for safer handling. Safer for you. Safer for your arrows.

Bear bow quivers are covered by U.S. patent 3,209,740.

3740 The Talisman Belt Quiver
Takes 10 to 12 arrows in the Talisman. Combines the best of side and hip quivers. Arrow separator and hidden belt tunnel. Carry extra string, tools, in the zipper pocket. Specify right or left hand. Tough vinyl, gold trim. Check the Bear belt.



3741 Talisman Hunter Belt Quiver
Split seconds count! Fastens to your belt ready for action. Holds six broadheads safely & quietly with rubber dividers and foam rubber base. Belt tunnel and tie-down thongs. Specify right or left hand. Bear makes a belt.



3745 Huntsman Belt Quiver
The silent one-rubber dividers cut shaft rattle and fletching rub on your six hunting arrows. Foam rubber protects the points. Vinyl. Double belt loop. Use right or left handed.



Slayton, Minnesota — Eldon Larson practices bowhunting and field archery until the winter snows start to cover his house and range. Larson began shooting with a hickory recurve eighteen years ago and has been the Minn. State Field Champion four times. He has four record book Whitetail Deer and one Black Bear to his credit and will go after Elk and Moose in Colorado this fall.



3584 4 Arrow Model

3585 8 Arrow Model

Fred Bear Kodiak Quiver
 Lengthened to better support and silence your arrows. Keep arrows from overhanging the end of the bow. Fits Bear Take-Down Bows manufactured since 1975 and all Bear Compound Bows. Kodiak Quivers feature Fast-Fork brackets top and bottom for easy-on, easy-off attachment.



3079 Screw-in Insert Adapter
 Adapt any 1/4" (6.35 mm) bushing to accept the Bear bowfishing rig, eight arrow Converta-Bow Quiver, Omni-Coupler® Stabilizer and Hunting Stabilizer.



7305 Bear Converta-Accessory Insert
 Holds Omni-Coupler, Fred Bear Hunting Stabilizer, Fred Bear Converta-Fish reel. With it you can mount the Fred Bear Eight-Arrow Converta-Bow Quiver. This insert is now standard on all Bear laminated bows except White Bear and Little Bear.





3380 Master Glove
Soft contour design for comfort. Elastic back, closed-end tips, Velcro® closure. Sizes 6-12. Can be used right or left hand.



Economical R & L Glove
Moderately priced right or left glove, open-end tips. Double-V seam. Sizes: x-sml, sml, med, lge, x-lge.

3430 vinyl **3435** leather



3330 Twin Tab
Black, smooth lining for clean release. Sml, med, lge. Specify right or left.



3315 Single Tab
Same as 3330, in single thickness. Sml, med, lge. Specify right or left.



7795 NEW Kantpinch Tab—now with hair face for smoother release. No more arrow pinch with patented finger separator. Replaceable calf's hide face, smooth back. Specify right or left. Small, medium or large.

7797 Replacement face for new Kantpinch tab.



7805 Wilson Tab
Adjustable finger loop. Smooth, heavy cordovan. Felt back. Sml, med, lge. Specify right or left.



3345 R & L Tab
Fits either hand. Assorted colors. Tough, smooth vinyl. Sml, med, lge.

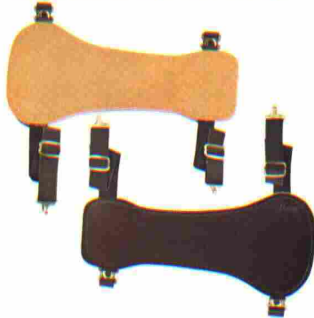

3445 Tartar Armguard
Snug fit, with elastic straps and fast-action hook fasteners. Tough vinyl, fully lined, reinforcing stay.

3450 Same as above, in leather.



3460 Kool Armguard
Concealed spring steel in fully lined vinyl. Adjustable elastic straps, with instant Velcro® fasteners. Cordovan brown.



3465 Ventilated Armguard
Cool comfort, reduces sweating, maximum protection. Velcro® fasteners and adjustable straps. Fully lined over spring steel wires, 6¾" (17.15 cm.) long, brown or white.



3475 Hunter Armguard
Extra wide for full protection. Fully lined leather for hunting. Spring steel stay. Three adjustable elastic straps, with instant Velcro® fasteners. Cordovan brown.

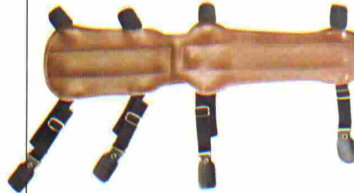

3485 Hunting Armguard
The length holds sleeves tightly in place. Ideal for the beginner, maximum full arm protection. Spring steel stay covered with lined vinyl. Four elastic straps with instant Velcro® fasteners.



3533 Bear Converta-Bowsling
Allows you to hold your bow in a light, natural grip without fear of dropping your bow. Attaches at the bow's Converta-Accessory Insert and is held in place by either a target or hunting stabilizer. For all Bear bows except White Bear and Little Bear.



3540 Bear® Bow Saddle
Soft pad cushions hand for comfortable, non-slip grip. Can be trimmed to fit any hand and bow contour. Adhesive peel-tab backing. Perfect companion to the Whitetail Hunter™.

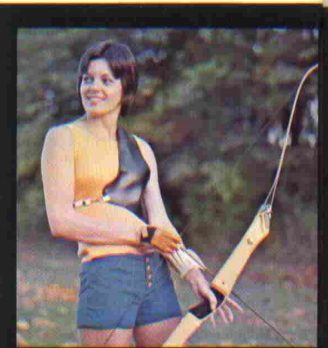

3542 Bear Chest Protector
The gals like the comfort and protection this vinyl covering provides. Keeps arrow and string away from bosom. White or black vinyl with ring fastener and flexible elastic section. Small and regular. Specify color, size, right or left.





2181 NEW Hard handle grips—rigid design for less hand movement. You have the choice of three different style grips—No. 1 is a standard grip, No. 2 medium, and No. 3 a high hand grip. All have a black, textured finish. Specify No. 1, 2 or 3, right or left hand.



4584 NEW Bear Paw Insulated Grip—for Bear Whitetail and Blacktail Hunter bows. Allows you to get a better grip on your bow and keeps that metal handle away from your skin on those cold autumn mornings. Easily installed. Specify right or left hand.



Clinton, Indiana—four members of the Kickapoo Archers of Peoria, Illinois, practice on the range at the Clinton Bowhunters' Nationals. Members of the club shoot bare bow only—no sights—and most members practice every day after work to keep up their proficiency.

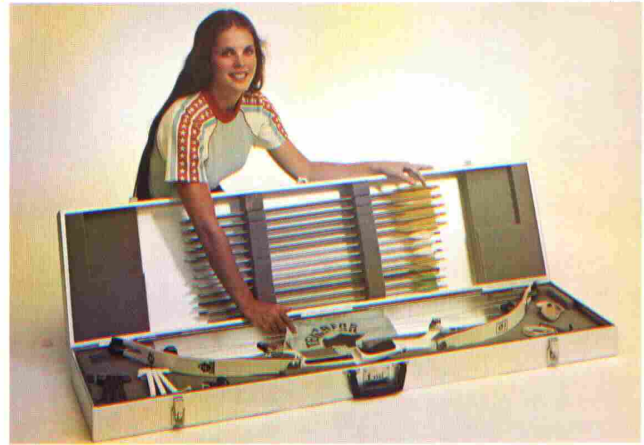

7790 NEW Bear-Kalispel Compound Bowcase—This durable, good-looking aluminum case is made by the Kalispel Indians of Washington State exclusively for Bear Archery. 56 x 14 x 6" (142.24 x 35.56 x 15.24 cm.) in size the case features foam lining and an etched aluminum finish. The case will hold any Bear Compound and most Compounds made by other manufacturers.



7785 Bear Take-Down Bowcase
Designed to hold the Bear Alaskan and Tamerlane II when disassembled or any other Bear Take-Down Bow. Will hold bow, a spare set of limbs, and other accessories. Can be used with bows other than Bear. Specify brown or white.



3495 Bear Assembled Compound Bowcase
For Bear Alaskan, Tamerlane II, Temujin II, Polar LTD, Kodiak Special, Whitetail Hunter, Blacktail Hunter and many other makes of compound bows. Designed to take bow with bow quiver and arrows installed. Available in two sizes: 50" (127 cm.) and 56" (142.24 cm.).



7780 Hunter's Compound Bowcase
Lightweight Camo Case in which to transport your strung compound bow with bow quiver and arrows attached. Protects your bow from scratches as you travel to your blind. Fits Bear Alaskan, Bear Polar LTD, Kodiak Special, Whitetail Hunter, Blacktail Hunter and many other makes of compound bows.

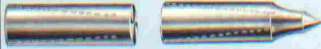

7341 Blunt **7347 Field**
Five Degree Taper-hole Points
 Machined steel standard-tapered field and blunt points for hunting practice. For $1\frac{1}{32}$ " (10.31 mm.) shafts, 125 grain (8.1 g.) weight. 10 pack.

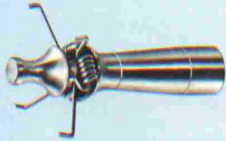

Miracle Converta-Judo Point
 End arrow loss! The magic spring arms dig in to prevent ricochet and burrowing. Stands in tall grass. Available with Converta-Point adapter.

7372 $\frac{5}{16}$ " (7.94 mm.) for aluminum and Fiberglass Converta-Point arrows.

7373 $1\frac{1}{32}$ " (8.73 mm.) for cedar Converta-Point arrows.

7370 $\frac{5}{16}$ " (7.94 mm.) Judo point without adapter.

7371 $1\frac{1}{32}$ " (8.73 mm.) Judo point without adapter.



7361 HTM Blunt Points
 Shoot safely in confined areas, or for small game. Tough rubber point fits over $1\frac{1}{32}$ " (8.73 mm.) squared-off shaft end or over metal blunt point. 125 grains (8.1 g.), half-dozen pack.



1340 NEW WACA high strength
 Wooden Arrow Converta-Point Adapter for $1\frac{1}{32}$ " (8.73 mm.) shafts only. 5 degree tapered magnesium. 10 pack.



1325 NEW Tuff-Tip
 Stop worrying about hitting those stumps. Fits over the end of your arrow between the fiberglass shaft and the Converta-Point. Virtually eliminates arrow splintering. Acts as a shock absorber. Dozen pack.



7865 Potawatomi Bow Square
 Find your correct nocking point and bracing height—the first time. Lightweight, non-corrosive aluminum.



5230 NEW Bear Super Razorhead®
 Factory sharpened Super hunting head ready for use, chisel pointed with edges honed to a razor-like finish. Edges are protected by a removable plastic coating.

Included in the package is a Bear Cut-master. After a shot, when the edge needs to be restored, several strokes with this instrument quickly bring it back. No need to buy new blades.

Insert blades are honed to a fine edge also. They are packaged on a handy pocket card with a slot cleaner.

Bear Razorheads have long been known for their fine flight characteristics. They perform excellently with either vanes or feathers. More game has been taken with these heads than with any other. 5 to a package.

5120 Ten insert blades and a slot cleaner, packaged on a pocket card.



Converta-Point® Components
 matched to Super Razorhead Weight

1332 Metric Magnum
Field Points

For use with Bear Metric Magnums and Metric Hunter arrows. Packaged 10 to a card.

1333 Metric Magnum
Blunt Points

For use with Bear Metric Magnum and Metric Hunter arrows. Packaged 10 to a card.

1332 Converta-Field Points
 for use with Bear Converta-point arrows other than Metric Magnums and Metric Hunters. Packaged 10 to a card.

1333 Converta-Field
Blunt Points

For use with Bear Converta-point arrows other than Metric Magnums and Metric Hunters. Packaged 10 to a card.

7372 Judo-Point $\frac{5}{16}$ " (.79 cm.) for aluminum and Fiberglass Converta-point arrows.

7373 Judo-Point $1\frac{1}{32}$ " (.87 cm.) for cedar Converta-point arrows.

The Fred Bear® Converta-point arrow is covered by U.S. patent 3,401,938.



7335 Razorhead Sheath

A protective cover to help keep your hunting heads Super Sharp. Slips easily over your Razorhead and protects it from dirt, rain, etc. Use Razorhead Sheaths to safely carry a couple of spare pre-sharpened heads in your tackle case or pack. Sold in package of five.



7000 Bjorn Nocks For those who desire a snap-on nock. Designed to grip the string. Translucent colors. Sizes: $\frac{1}{4}$ " (6.35 mm.), $\frac{5}{16}$ " (7.94 mm.) and $1\frac{1}{32}$ " (8.73 mm.).



7005 Fred Bear Speed Nocks

Preferred by bowhunters and target archers alike. Index ridge assures proper placement of the arrow on the rest. Hunters can keep their eye on the game while nocking their arrow. Fast-loading, open throat with reinforced edges. Sizes: $\frac{1}{4}$ " (6.35 mm.), $\frac{9}{32}$ " (7.14 mm.), $\frac{5}{16}$ " (7.94 mm.) and $1\frac{1}{32}$ " (8.73 mm.).



7732

Three Nok-Sets, with pliers.

7733 Nok-Set

Aluminum banded with live plastisol. Slip-proof. Positive, permanent nocking point. Package of five.



7269 Bear® Nocking Points

An instant nocking point. Heat-shrinks onto string. Four points per package.



7273 Bear-Gluv®

Eliminates need for finger protection, yet gives positive nocking point time after time. Special new material will not slip or damage string. Two sets per package.



"Fred Bear Showed Me How"
T-Shirts

Attractive, full color T-Shirt. Sets you apart as an archery expert. A real conversation starter. To order, use the reply envelope bound into this catalog. We pay postage.

Adult Sizes: **Catalog No. 8700**
 Specify size: small, medium, large or extra large.

Youth Sizes: **Catalog No. 8701**
 Specify size: small, medium or large.

Juvenile Sizes: **Catalog No. 8702**
 Specify size: small, medium or large.



7823 Bear® Archery Patch

Identify yourself. Ideal for club shooters, teams. Embossed back patch, official Bear emblem in green, black; 7" (17.78 cm.) diameter for jackets, shirts.

7824 Bear Shoulder Patch
 Same as above in 3" (7.62 cm.) diameter.

7827 "Fred Bear Showed Me How" Shoulder Patch

Answers the obvious question for you when you step back from the line, or return from the woods or field with your game. 3" (7.62 cm.) sew-on patch.

7828 "Bowhunting Spoken Here" Shoulder Patch

A 3" (7.62 cm.) patch that makes points in any conversation. Sew it on your hat or jacket.

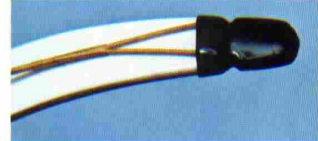

7845 Bow Tip Protector

Holds bowstring in place on lower limb. Protects tips from damage. Wear-resistant plastic. Fits any recurve bow.



7057 Fred Bear® Bowstring Wax

Get more wear from your bowstrings by waxing them frequently. Designed especially for synthetic fibers. In convenient pushout tube.



Single Pack of Bear® Universal Temper Strand Bowstring

Top performance bowstrings for your Compound or Recurve. Available in the following lengths and weights:

Compound bowstrings

7033 Hand-rubbed, double-loop B-50 Dacron® Compound string for Compound bows with peak weights up to 50 lbs. (22.50 kg.). Available in 37", 39", 42", 43", 44" and 50" (93.98, 99.06, 106.68, 109.22, 111.76 and 127 cm.).

7032 Hand-rubbed, double-loop B-50 Dacron® Compound string for Compound bows with peak weights from 51 to 70 lbs. (22.95 to 31.50 kg.). Available in 37", 39", 42", 43", 44" and 50" (93.98, 99.06, 106.68, 109.22, 111.76 and 127 cm.).

Recurve bowstrings

7036 Bowstring for recurve bows up to 50 lbs. (22.50 kg.) draw weight. Hand-rubbed, double-loop B-50 white Dacron® with yellow serving in lengths: 60", 62", 64", 66" and 68" (152.40, 157.48, 162.56, 167.64 and 172.72 cm.).

7051 Bowstring for recurve bow up to 70 lbs. (31.50 kg.) draw weight. Hand-rubbed, double-loop B-50 black Dacron® with green serving in lengths: 48", 52", 54", 56", 60", 62", 63", 64" and 66" (121.92, 132.08, 137.16, 142.24, 147.32, 152.40, 157.48, 160.02, 162.56 and 167.64 cm.).

Note: In accordance with AMO, the Compound bowstring lengths listed are the actual length of the string when under tension. Early Compound bowstrings were measured under a different standard. If you are not sure of the length string required for your bow, measure the old string installed on your bow or look up the length as listed under specifications for your bow model in the front of this catalog.



7101 Single-loop Bowstrings

For all bow lengths and weights to 40 lbs. (18 kg.). Single-loop braided B-50 Dacron® with center serving.



7060 Fred Bear® String Server

With black nylon thread. Hook over string for fast serving. Enough here for 60 servings.

7061 Server with monofilament thread.

7062 Nylon thread only; red, yellow, black.

7063 Monofilament thread only.



4876 Bear High Let-Off Eccentric Wheels with dual needle bearings—

Improve your Polar II, Polar LTD or Whitetail Hunter Compound bow with these slick eccentric wheels with dual needle bearings. 50% let-off, available in either long or short draw lengths. Can be used on Bear Alaskan or Tamerlane II Compounds to provide a higher let-off. Specify small for draw lengths or 26½ to 29" (67.31 to 73.66 cm) or large for draw lengths of 28½ to 31" (72.39 to 78.74 cm). Package of two.



4874 Polar/Whitetail Hunter Weight Adjustment Brackets

Everything you need to customize your Polar II or change your Whitetail Hunter to a Compound with six adjustable peak weight settings just like the new Polar LTD. You can update your own bow at home or have it changed at any of Bear's Authorized Bear Archery Service Centers. Conversion of a Whitetail Hunter will require the use of a compound bowstringer and a 4580 Bear Compound Cable Changer Brackets.

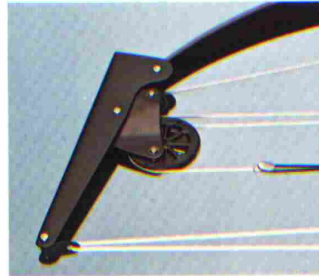

4580 NEW Bear Compound Cable Changer Brackets

Required to change cables on Whitetail Hunter Compounds. Attaches over the limb ends and works in conjunction with the Bear Compound Bowstringer (not provided) to keep tension on your bow while you change cables. Small and compact enough to carry in the field.

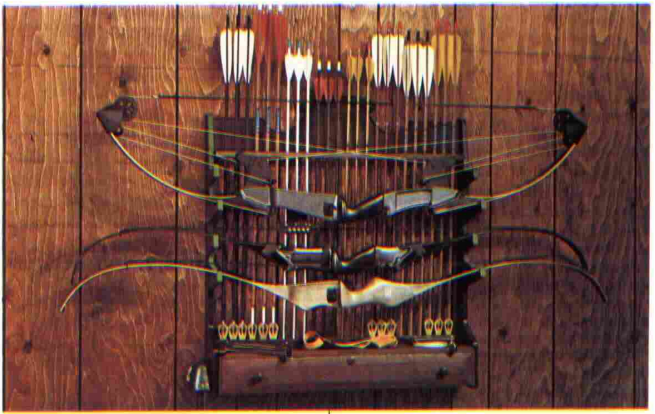

7077 New Fred Bear Archery Rack

Display up to 5 bows and 24 arrows on this wood grained plastic rack. Features built-in bow quiver holders, a place to hang your shooting gloves and a pull-out drawer to store your accessories. A great way to show off your archery tackle. Shipped disassembled.



7071 Wall Bow Rack

This is the bow rack that Fred Bear uses in his office. It's a real space-saver and will fit just about anywhere. Holds 5 bows on 16" (40.64 cm.) of wall space. Comes with screws so you can mount it flush against the wall and it also includes the hardware so you can use it on pegboard. Not for Compound bow.



4575 NEW Bear Compound Bowstringer

A fast and easy method for changing the string on your Compound bow. A tent rope-type stringer that fits all Bear and most other Compound bows.

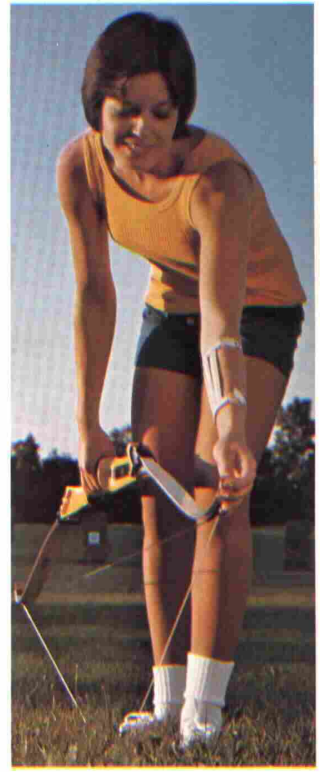

How to String a Bow Safely

You still see archers using the push-pull or step through stringing method. Wrong! You can hurt yourself, and you can damage your favorite bow. Instead, the safe and easy way is with the 7850 Three-Bear Bowstringer. Simply stand on the cord after you attach the bowstringer to bow tips. The tips bend as you pull up, ready for easy, safe stringing. You're in good company; this is the bowstringer used by pros.



7850 Three Bear® Bowstringer

The safest way to string a recurve bow. Imported calthide pockets and nylon cord. Also works on bows with bow tip protectors.

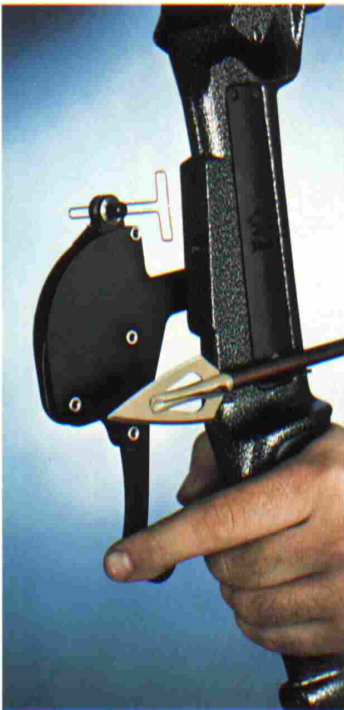

7555 NEW Bear Trigger Sight™

A fantastic new Hunting Bowsight with a built-in rangefinder that automatically compensates for the distance between you and your target. Just place the sight window on your target and squeeze the sight handle with your finger until the target and sight line up. Instantly adjustable for various bow weight changes. Fits all Bear Compound and Take-Down bows with no drilling. Can be adapted to most other bows. Use a Trigger Sight and make your first shot count, every time.

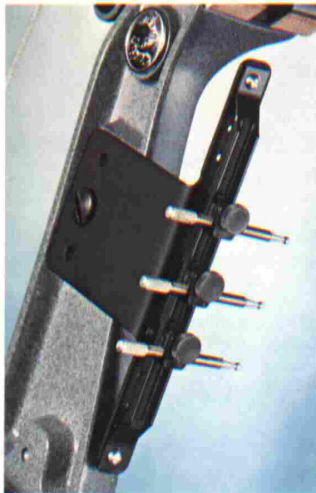

7560 Shur-Hit Hunting Sight with Bracket

The three sighting bars adjust easily to any yardage you preset. Pins lock securely with thumb screws. Fits all Bear bows with Universal Sight Stage, can also be tape or screw mounted.

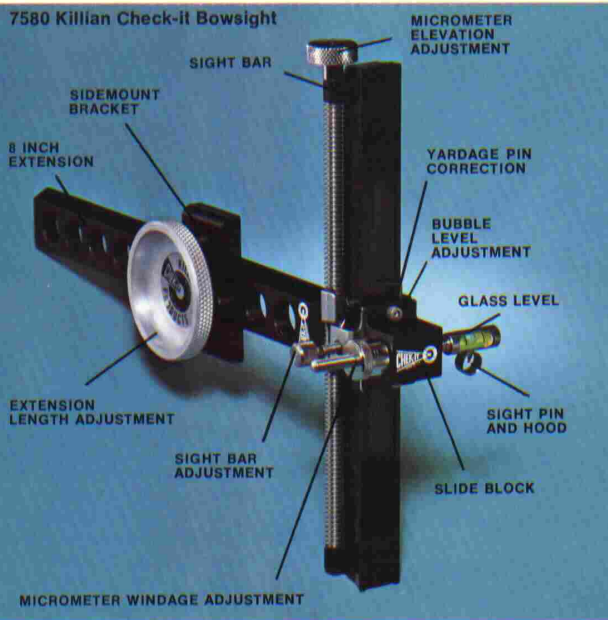

7580 Killian Chek-it Bowsight

The sight used by more of the world's professional archers than any other. Features Micrometer Windage Adjustment, Yardage Pin Corrector, Micro Elevation Adjustment, Bubble Level Adjustment, Accurate Glass Level and more. Works right or left handed. Side mounted on bow for better clearance. Complete mounting instructions and mounting plates included.

7585 Bear Killian Chek-it Sight Base Adapts the Killian Chek-It Bowsight for use on the front of the Bear Victor and Tamerlane II Compound Bows.

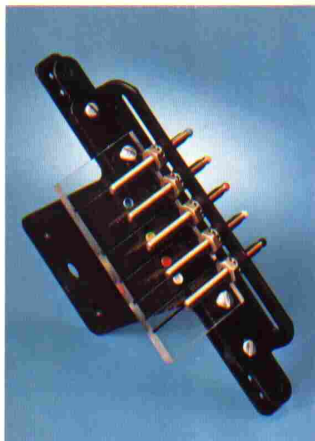

7618 Improved Rain-Bow Hunting Sight

Built-in rangefinder lets you preset five distances. Simply use the clearly visible color-coded pins—blue, yellow, red, white, black. Complete with bracket to fit Bear Universal Sight Stage. Can also be tape or screw mounted.



7670 String Peep Sight

Put this on your string, and you have a rear sight for perfect alignment. Unbreakable vinyl, weatherproof.



6105 Bear Premier Hunting Sight

This fine sight becomes an integral part of your bow. Complete with bristle rest, adjustable nylon arrow plate and three fluorescent sight pins you preset for three yardages.

6100 Field model 3 3/4" (9.53 cm.) hunting sight—fits Victor Magnum® handle section.

6105 Field model 5" (12.70 cm.) hunting sight—fits Victor Kodiak®, Bear Alaskan and 50" (127.00 cm.) Tamerlane II bows.



Bear® Scor-Mor Sight

7558 Deluxe Target and Field Sight with Bracket that has all the features of sights selling for much more. Complete with micro windage and elevation adjustments.

7557 Field sight, with hood and post. Makes smooth sight adjustments with unique design of polyethylene and anodized parts.

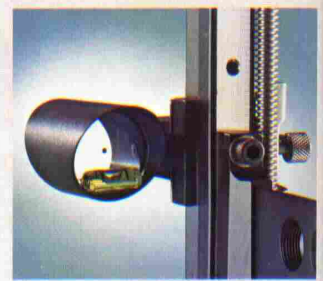

7550 Bear Selector Scope

Sight—a 3-power magnifying scope for your Killian Chek-it, Shur-Hit or Scor-Mor sight. Use it for a clearer and larger picture when you aim. Lightweight black anodized body, specify right or left hand.

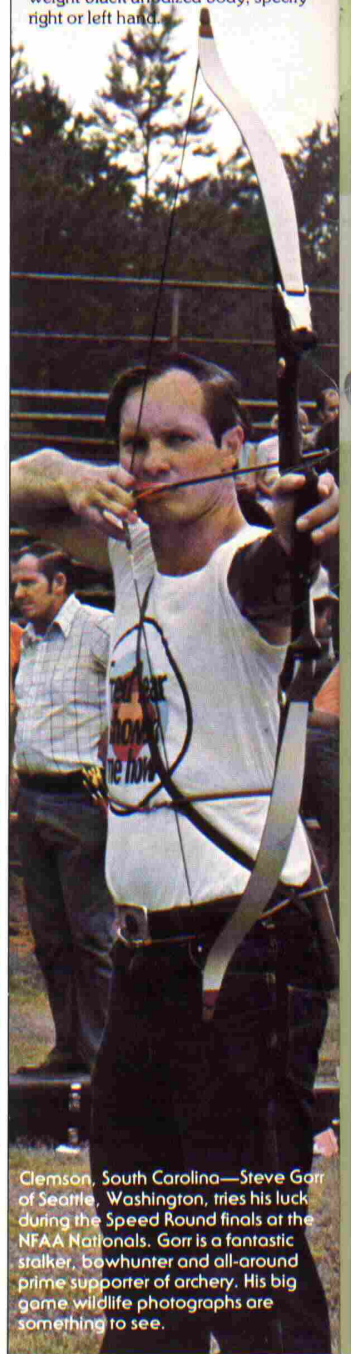

Clemson, South Carolina—Steve Gorr of Seattle, Washington, tries his luck during the Speed Round finals at the NFAA Nationals. Gorr is a fantastic stalker, bowhunter and all-around prime supporter of archery. His big game wildlife photographs are something to see.



7306 Bear Easton Stabilizer

Improve the accuracy of your target shooting. Bear Easton Stabilizers help to balance your bow and absorb the shock of arrow release, therefore, providing a more stable platform from which to shoot. These Stabilizers work very well with compound bows. Chrome plated for good looks, available in three lengths and can be used with a variety of head weights.

7306 Bear Easton Chrome Stabilizer with 3½ oz. (99.22 gm.) weight. Specify 24", 30" or 36" (60.96, 76.20, 91.44 cm.) length.

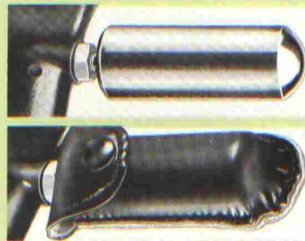

7320 Bear® Hunting Stabilizer

Improve accuracy. Reduce string noise. Cut bow movement. Get better arrow clearance. Improve the feel-all with this compact stabilizer. Chrome-plated weighted head and built-in flexible coupler. Makes an ideal Counter Balance Weight also. Fits any 1975 or later composite Bear bow except White Bear and Little Bear. Complete with camouflaged case for hunting. With the 3079 adapter, you can add the Bear Hunting Stabilizer to other make bows with ¼" (6.35 mm.) stabilizer bushing.



7310, 7311, 7312 Bear Omni-Coupler™

Give your arrow a truer flight; improve your accuracy. The device counteracts the shock and vibration of the limbs after arrow release for a faster dampening action. Select the right combination of color-coded interchangeable compressible bushings, two interchangeable heads, and lightweight tubular rod to complement your own style.

7310 Bear Omni-Coupler with tubular rod and two weighted heads; carrying case.

7311 Bear Omni-Coupler with two interchangeable compressible bushings. Red, soft action; black, stiff action.

7312 Bear Omni-Coupler with two interchangeable compressible bushings with ¼"-20 threaded stud to fit other bushings. Red, soft action; black, stiff action.

The Bear Omni-Coupler is covered by United States patent #3,524,441.



3079 Screw-in Insert Adapter

Adapt any ¼" (6.35 mm.) bushing to accept the Bear Bowfishing Rig, Eight and Four-Arrow Converta-Bow Quivers, Omni-Coupler Stabilizer and Hunting Stabilizer, and Counter Balance Weights.



7302 5/16" (7.94 mm.) Counter-balance Adapter Stud

Permits you to use the 3 or 4½ oz. (85.05 or 127.57 gm.) Bear Stabilizer Weights as counter balances.



7279 Kissar Button

Touches your lips when you've reached full draw. Attach to bowstring for consistent shooting.

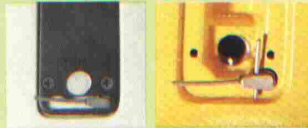

6160 Bear Premier Magnetic Arrow Rest

Eliminates arrow drag. Rest retracts away from arrow at moment of release. Includes cadmium plated flipper, bar pin, magnet and rubber bumper. Fits Victor and long Tamerlane II.



7205 "Match 1" Arrow Rest

To be used in conjunction with a cushion-plunger like the Bear Super Berger Button. "Coil-Spring" design with vertical and horizontal "give". Allows for easy bow tuning and may be used with any type of fletching. Specify right or left.

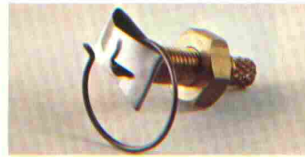

7208 Hughes Arrow Rest—

designed by tournament archer David Hughes. Fits thru the bow and acts as an arrow rest and cushion plunger. Comes complete with heavy and extra heavy support wires so you can tune to your style of shooting. Also included is a self-adhesive pad and plastic tubing for use when bowhunting. Specify right or left hand.



7210 Bear® Premier Flex-rest

Use in combination with Bear Premier sight plate. Specify right or left. Self-adhesive.

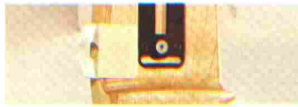

7282 Arro-Guide Arrow Rest

Ideal for all bows not equipped with arrow shelf. Fits all glass or wood bows. Plastic fingers hold arrows with no harm to feathers. Adhesive back, for right or left hand, easily removed.



7283 Hoyt Pro Rest

This rest provides for positive clearance of vanes and feathers. Non-interfering rest with pressure plate. Retaining finger holds arrow in place. No arrow bounce. Self-adhesive. Specify right or left.



3555 Bear® Bristle Rest

For hunting, field. Installs in seconds on any bow, right or left. New 10 degree angle. Longer and stiffer.

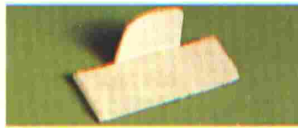

3572 Bearhair® Arrow Rest and Bear® Silent Arrow Plate

The Bearhair Arrow Rest provides a quiet platform on which your arrow rides when you draw your arrow back and the Bear Pre-Furred Arrow plate gives you a smooth, silent wall against which your arrow slides. Self-adhesive, for right or left hand.

3575 Bear® Vinyl Silent Arrow Plate Only

Same as Pre-Furred Silent Arrow Plate, only in leather.



3545 Bear Weatherrest™

This is the rest that was designed to help you get the most out of new Bear Weathers™, feathers and vanes. Great rest for hunting, target or field. Complete with a self-adhesive back, this rest installs in seconds on almost any bow. Very quiet for hunting, holds your arrow with the Bear finger. Specify right or left.



7200 Springy Arrow Rest

Installs through the bow to hold the arrow and act as a shock absorber. Rest is fully adjustable for center shot tuning and has both horizontal and vertical flexing action. Specify right or left.



7180 Bear Release

A quiet, torque-free rope release for use on tournament and hunting bows. Draw by pulling with the index finger and release by squeezing with the second and third fingers. Specify right or left.



Bear Hot Shot Release

Mechanically activated rope releases with fully adjustable travel speed. Aluminum body with all internal working parts made of steel tempered to maximum hardness. For use hunting or tournament shooting. Operate right or left handed.

7195 2-finger pull model

7175 3-finger pull model



6275 Super Berger Button

A spring-tension Teflon® pressure point that works like a shock absorber to minimize the effects of a bad release. Simply dial the correct amount of center shot you want — like focusing a fine camera.



7281 No-Freeze Klicker

You hear the click at full draw, to prevent your freezing and to improve your technique. Chrome-plated spring steel. Adhesive back.



7260 Bowhunter Gloves
Deerskin gloves for warmth, style, action. Leather-tipped shooting fingers (specify right or left). Alderbark brown. Sizes 7, 8, 9, 10, 11.



3130 Fred Bear® Bowhunter's Kit
Compact and ready to use. Includes hunting knife with impact-proof handle, file and stone for sharpening broadheads, extra pocket for bowstrings. High-quality knife blade extends fully into decorated bone handle.



3135 File with handle.



3140 File case; top grade leather with belt loop.

3145 Sharpening stone; best quality for knife and Razorheads.



7255 Fred Bear® "Cutmaster" Knife and Broadhead Sharpener
Get the edge — a real cutting edge — on any knife or broadhead. Weighs ¼ oz. (7.09 gm.). Small enough to slip into your pocket.



7138 Camouflage Bow Cover
Two-piece cover to slip over bow limbs. Conceals without hampering your shot.



7135 Compound Camo Sleeves
Camouflage sleeves with Velcro® fasteners for Bear and other makes of compound bows. Snaps around limbs and conceals without hampering.



7830 Brush Buttons
Prevent snagging on underbrush. Silences string noise, yet does not interfere with bracing or accuracy. Slip two soft rubber buttons onto bowstring. Two sets per pack.



7160 Fred Bear® Camouflage Make-up Cream
Blend in with the woods. Three tubes: Bark Brown, Glade Green, Shadow Black cream, for face, hands, bow. Cold cream base, applies easily.



7015 Bear-Cote®
Protect your bow with this fantastic new polymer coating. Especially good on laminated products such as bows and skis. Prevents deterioration due to ultraviolet rays and protects against the elements. Keeps your bow new looking. Excellent for cleaning and fog-proofing eye glasses. 1¼ oz. (35.44 gm.).



7211 Bear Shooting Glove Powder
Eliminate sticky fingers. Apply to shooting glove or to tab for a friction-free silk-smooth release. Spray on sweaty hands. Squeeze-bottle dispenser, ¾ oz. (21.26 gm.).



7838 "Mity Quiet" String Silencers
Don't spook game when you shoot. Twin rubber-like burs wind into bowstring ends. Ends twang sound. Two sets per pack. For compound or recurve bows.



7723 Kwik-Lok Arrow Holder
Virtually automatic; great for cold hunting days. Kwik-Lok holds arrow nocked in the bow ready for that quick shot. Draw, and it releases automatically. Self-adhesive, for compound or recurve bows.



7222 Cutter Insect Repellent
Three drops of Cutter's cream formula thwarts gnats, mosquitoes, ticks, black flies. Won't rub or sweat off. Economical and long-lasting.



7840 Bear Cable Silencers
The answer to cable twang on Compound bows. Fit these rubber silencers over your cables and fit into place with nock sets or serve with dental floss. Help keep cables from slapping together.



NEW Camo Clothing

After many requests "Grayling Tuxedos" are again available. Bear offers a complete line of Camouflage clothing designed by bowhunters for bowhunters. Fred Bear Camo clothes are warm, comfortable and, most importantly, very quiet in the field. Jacket and pants are heavy cotton with 3.3 oz. (93.55 gm.) Polyester fill. Machine washable and quick drying. Vest is heavy cotton with 9 oz. (255.14 gm.) Dacron II® fill.

7114 Fred Bear Camo Jacket
Available in Small, Medium, Large and Extra Large.

7116 Fred Bear Camo Pants
Available in Small, Medium, Large and Extra Large.

7118 Fred Bear Camo Vest
Available in Small, Medium, Large and Extra Large.



7020 Bear-Epoxy
Bear-epoxy is the glue of the space age. Great for affixing nocks, Broadhead Adapter Inserts, Razorheads®, field or target points to your aluminum, fiberglass or wood arrow shafts. Can also be used for concrete, brick, glass, fabric, cement and rubber. Waterproof, Bonds, Seals, Fills. Multipurpose, non-toxic. 1.5 fl oz. (42.53 gr.).



8710 Team Bear Windbreaker
White nylon windbreaker with blue trim and distinctive Team Bear Logo. Available in extra small, small, medium, large & extra large. Available from your local Bear Archery dealer or through the return envelope bound into this catalog.

8715 Team Bear Shooting Shirt
Red, White and Blue T-shirt with the Team Bear logo. Good looking and long lasting, these shirts are available in small, medium, large and extra large. Available from your local Bear Archery dealer or through the return envelope bound into this catalog.



8720 Team Bear Applique
Team Bear logotype in a small stick-on patch. Just right for shirts, jackets, quivers, bowcases, etc.



7971 "Bowhunting Spoken Here"
Transfer decal, 8" x 3¼" (20.32 x 8.26 cm.), for car window, rec room, trailer, etc.



7870 Bear Tie Tac
Wear the Bear and identify yourself. An excellent conversation starter. Gold or silver colored finishes, may also be worn as a lapel pin. Ideal gift for the archer. Please specify color.

8705 Fred Bear Sports Club Tie Tac
Exact replica of the official FBSC Charter Member Patch. These are in full color and can be worn as a tie tac or lapel pin. These are available to Charter Members of the Fred Bear Sports Club only.

7875 Razorhead Tie Tac
Perfect way to show you're a bowhunter. An interpretation of the famous Bear Razorhead, designed by one of the country's leading jewelers. Gold or silver colored finishes, may also be worn as a lapel pin. Please specify color.

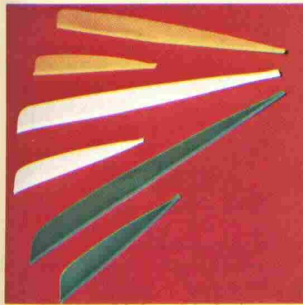

NEW Bear Weathers™
 Bear's Space Age replacement for turkey feathers is now available for the do-it-yourselfer. These injection-moulded plastic vanes are dimensionally stable, moisture-proof and unaffected by moisture.

6700 Bear Weathers™
 2½" (6.35 cm.) fluorescent-colored fletch for use on target arrows. Choose either White, Yellow or Green. 50 to a package.

6710 Bear Weathers™
 5" (12.7 cm.) fluorescent-colored fletch for use on field or hunting arrows. Choose either White, Yellow or Green. 50 to a package.



Bitzenburger Dial-O-Fletch
 Fletch arrows diagonally, straight or with true helical, right or left hand. Precision die-cast, form-fitting, thumb controlled clamps. Graduated scale on side of clamps accurately spaces Weather™, feather or vane from nock—120°, 75°x105°, 90° or 60°. Self-centering nock receiver fits all nocks.

7038 Jig with helical clamp (Specify right or left).

7039 Jig with straight clamp.



7022 Bear-Tite Archery Cement
 Quick-drying cement for fletching Weathers™, feathers or plastic vanes on wood, aluminum or glass arrow shafts. Can also be used for glueing nocks. Waterproof and long lasting. ¼ oz. (21.26 gm.). squeeze tube.



7024 Ferr-L-Tite Cement
 For points and ferrules. Apply with heat. Doesn't get brittle. Squeeze tube, ¼ oz. (21.26 gm.).



7025 Bear Quick Stick Cement
 Apply with heat. Dries quickly without becoming brittle. Approx. 1 oz. (28.34 gm.).



9500 New Bear Lighttarget™
 A fantastic new Archery Target that is long-lasting, lightweight and resists the effects of moisture, insects and small critters. Comes complete with stand, 80 cm. printed target sleeve, sand bags for support and interchangeable target sections for three times the target life. The front of the target is 30" (76.20 cm.) square and the entire target weighs less than 10 lbs (4.54 kg.). Not for use with broadheads.

Replacement kits
9510 Target sleeve, clear sleeve and two target sections.
9515 Target frame (all four pieces).
9520 Target stand (with tie string).

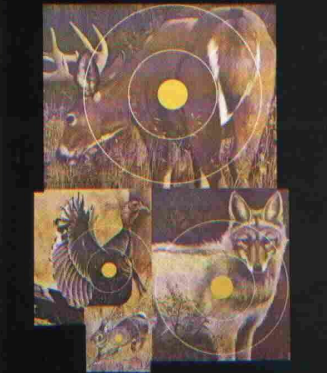

NEW Official NAA and FITA Field and Hunter Faces
 Full-color animals that you have to see to believe. Absolutely beautiful!
7393 60 cm. deer (approx. 24")
7392 45 cm. coyote (approx. 18")
7391 30 cm. turkey (approx. 12")
7390 15 cm. rabbit (approx. 6")

Multi-use Targets
 Full-color animal faces. Lifelike forest creatures on extra-heavy paper. Circled aiming spots.
7501 60 cm. deer 2 per pack
7502 60 cm. target 2 per pack
7503 45 cm. coyote 3 per pack
7504 40 cm target 4 per pack
7505 30 cm. turkey 4 per pack
7506 15 cm. rabbit 4 per pack



Full-color Official FITA and NAA Faces
 Square: **7451** 40 cm. **3660** 60 cm.
7452 60 cm. **3665** 80 cm.
7453 80 cm. **3675** 122 cm.
7455 122 cm.



NEW!
7386 Standing buck, with vital organs and bone structure outlined.



Fred Bear® Life-sized Animal Targets
 Shoot at them, or admire them; for field or den. Artwork in sepia-tone. All 35" x 45" (88.90 x 114.30 cm.).
7380 white tail buck, rear view
7381 white tail buck, eating
7382 standing buck
7383 running buck
7384 white tail doe, running
7385 set of all five

NEW Fun Face Target Sets
 These exciting new targets add a new dimension to archery fun and skill.



7490 English Darts Target and Alphabet Game Target.
 One of each per pack.

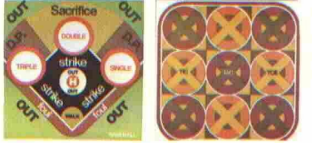

7491 Baseball Target and Tic Tac Toe Target. One of each per pack.



7492 Poker Target and Twenty-One Target. One of each per pack.

7436 Indoor PAA and AIAA Official Face
 20" (50.80 cm.) blue with white bull. Score lines out of sight at line.

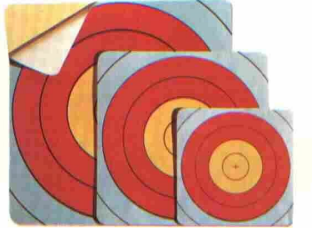

NEW Official NAA and FITA Target Patches
 Full-color patches with peel-off, pressure sensitive adhesive on back. Don't throw your shot-up target faces away. Recycle them with new NAA and FITA Target Patches.
7460 122 cm. **7458** 60 cm.
7459 80 cm. **7457** 40 cm.



7525 Nylon Mesh Backstop
 Stops arrows from popular weight bows. Ideal for clubs, camps, schools, indoors, out. Order by size: 8' by 9' (2.44 x 2.74 m.) or 8' by 15' (2.44 x 4.57 m.) (both include hanging cables).

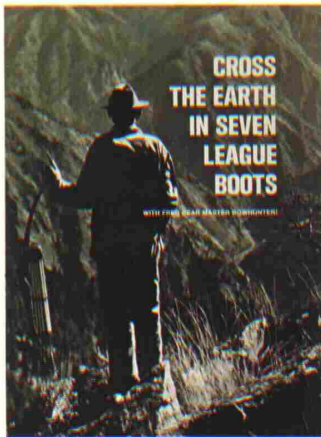

Exciting Archery Films for your viewing enjoyment

Fred Bear has put together one of the very best adventure film libraries in the country and these films are available for your use. You and your friends can rent them for use at:

Sports and Conservation Clubs • Archery Clubs • Service Clubs • Church Groups • Camps • Scouts • Hospitals • Banquets • National Hunting & Fishing Day • and numerous other activities

The average running time of these 16 mm films is 23 minutes. Rental fee: \$10.00 for each film. Allow 30 days lead time. Send check or money order to: Fred Bear Sports Club Film Library, 15921 West Eight Mile Road, Detroit, Michigan 48235 Phone 313-273-2070.

Titles Available:

Archery... Right On! A new film giving the newcomer to archery a brief look at all phases of the sport including a few of the basics of shooting. A good introductory film.

Rural Route One, Grayling, Michigan. Another new film showing how our handcraftsmen make Bear bows and arrows. Narrated by Fred Bear.

Kaibab Bucks First bowhunt season in Arizona's Kaibab Forest and **Grubstake Bowhunt** Stalking Dall sheep in Alaska.

Trophy Elk Bowhunting the Royal elk in the Wyoming Rockies and **Bowhunters Safari** Fred Bear hunts in French Equatorial Africa.

Backcountry Bowhunt North American big game bowhunt.

Prairie Pronghorn An antelope hunt on the Western plains and **B'wana Bowman** In pursuit of the African Congo elephant with bow and arrow.

Badland Bucks North Dakota mule deer hunt and **Arrow for a Grizzly** Fred Bear meets grizzly bear in the Yukon wilds.

North to Adventure Record Stone sheep hunt in Canada.

Bowfishing Fun Archery's off-season sport and **St. Vincent Island** Stalking through Florida Tropical Paradise.

The Oldest Game An exciting white-tail deer hunt.

†**ABC-TV's American Sportsman Grizzly Hunt** Features Fred Bear and grizzly bear.

Land of the Tiger Fred Bear in the land of the Bengal tiger, with bow and arrow.

Kodiak Country Hunting the huge Alaskan Kodiak bear.

Fins, Feathers, and Fur Bowfishing for stingray and alligator gar; bowhunting for bobcat and pheasant.

Mozambique Game Trails Big-game bowhunting in East Africa for nyala, impala, greater kudu, waterbuck, bull elephant.

†**ABC-TV's American Sportsman** Fred Bear's successful Polar bear bowhunt. Part two is of mule deer hunt in New Mexico.

The Year of the Cape Buffalo Fred Bear and Wally Johnson team up to go after the world's meanest game.

25th World Archery Championship International archers competing for coveted world's top prize at Valley Forge, Pa.

Archery Today Bowhunting education and advice for novice and expert. Write us about films for TV use.

†Cannot be used for TV or for paid audiences.

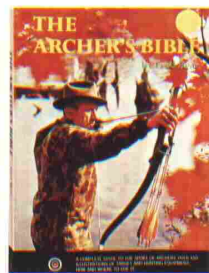

Recommended Reading

7825 The Archer's Bible, by Fred Bear is Fred Bear's complete guide to archery. Covers fundamentals; improving your shot; targetry; small and big game bowhunting; bowfishing; care and safety of equipment; 150 illustrations, including photos of Pope & Young award-winning trophies. For the tyro and pro archer alike. For yourself. As a gift.

7810 Bow & Arrow Big Game Hunting in Wisconsin by Otis Bersing. Fascinating reading for hunters around the country. Contains every imaginable statistic on bowhunting in Wisconsin.

7811 Archery Champions—3rd Edition. Covers sport from 1930 to 1962. Gives the scores and biographies of the champions with photos. — By Robert Rhode.

7812 Archery Champions—4th Edition. Covers sport from 1963 to 1971. — By Robert Rhode.

7813 The Basic Technique of Instinctive Field Shooting, published by NFAA.

7814 Archery Instructor's Guide

7815 The Archer's Handbook. NAA (and FITA) Official Rule Book.

7816 NAA Instructor's Manual An excellent teaching aid compiled by the members of the National Archery Association's Instructional Committee. Covers subjects such as tournament management, problem corrections, equipment maintenance and storage, bow tuning, advanced shooting, archery history, as well as archery instruction. A must for anyone teaching archery.

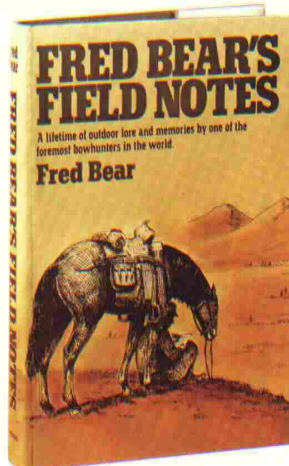

7826 NEW Fred Bear's Field Notes

A Book by Fred Bear from Doubleday. With a bow, camera and notebook, Fred Bear's adventures have taken him to almost all places of the world. The bow to collect an occasional trophy. The camera to record events and his notebook to bring you, in diary form, the day-by-day accounts of fifteen of his most exciting trips.

These notes were written under assorted circumstances. On the blistering hood of an African safari car, snowed under in a tent camp forty miles out on the ice pack, or pampered in a royal palace in India.

Not tales of simply killing but the entire essence of outdoor life. Relive with Fred his harrowing experience while pinned down for six hours by a lion. Read his thoughts as a giant Kodiak bear came within 20 feet of him. Learn what it is like to be the personal guest of the Maharaja of Bundi.

With this narrative of his adventures he invites the outdoorsman in all of us, whether accomplished or armchair, to share his own special world of life on natural terms.

More than a hundred pictures. HARD COVER \$8.95.

At your Bear Archery dealer, book store, or send check or money order for \$8.95 to the Fred Bear Sports Club, Grayling, Michigan 49738.

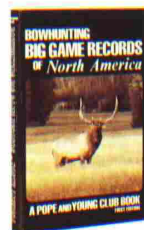

7832 New Pope and Young Club "Bowhunting Big Game Records of North America" Book This New hard cover book features the history of the Pope and Young Club, History of the Awards, a chapter on how to measure and enter trophies, Minimum scores and measurer list, Interesting articles on how to hunt the species, Saxton Pope and Art Young photos, Record tabulations, photographs and the stories behind the world record trophies. This book is a must for the serious bowhunter.

You may purchase this book thru the return envelope bound into this catalog.

7818 Power Archery

7819 "Let's Raise Our Score," by Dick Young

7821 Archer's Digest, edited by Jack Lewis, editor of Bow & Arrow Magazine. This is the encyclopedia for all archers. More than 300 pages of illustrations and informative tips. Just the thing for beginners or pros.

7806 Winner or Loser? by Shig Honda and Ralph W. Newson. A good book to raise the score of a target archer. Not only does the book teach the methods of tournament archery, but it also explains the mental preparation required.

7820 Bowhunter's Digest by C. R. Learn. All the information you need to become a successful bowhunter. 288 pages on the knowledge, skills and equipment needed to bring home your trophy.

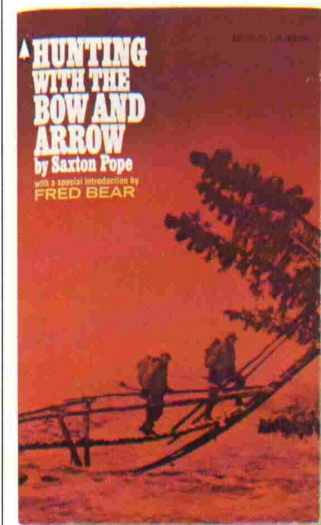

7817 Hunting With The Bow & Arrow by Saxton Pope

This is the book that details the early days of modern bowhunting as done by Saxton Pope and Arthur Young. It is a fascinating journal including sections on Ishi, the last wild Indian who lived in North America, how to make bows and arrows, the principles of hunting, chapters on deer, bear, mountain lion, small game, grizzly bear and the story of Art Young's two trips to Alaska.

This volume belongs on your bookshelf. You may purchase it from your Bear Archery dealer or by sending in \$1.95, check or money order in the return envelope bound into this catalog direct to the Fred Bear Sports Club in Grayling.

Magazines

Archery World
225 E. Michigan
Milwaukee, Wisc. 53202

The Big Sky
% The Fred Bear Sports Club
Rural Route One
Grayling, Michigan 49738

Archery Magazine
Route #2, Box 514
Redlands, California 92373

Bow and Arrow
34249 Camino Capistrano, Box 88
Capistrano Beach, Calif. 92624

Bowhunter Magazine
P.O. Box 5377
Fort Wayne, Ind. 46805

National Archery Organizations



National Archery Association (NAA)

1951 Geraldson Drive
Lancaster, Pennsylvania 17601
The U.S. representative of the Federation International De Tir AL'Arc (FITA). Membership is involved in Olympic, Jr. Olympic programs, and college level programs, teach instructor certification programs and work in all phases of amateur archery.

National Field Archery Association (NFAA)

Route #2, Box 514
Redlands, California 92373
A very active national group with a fine Field Archery Organization and awards program.

Professional Archers Association (PAA)

P.O. Box 7609
Flint, Michigan 48503
Members teach archery, shoot in the annual national archery Pro-Tour, give clinics, maintain standards.

Pope & Young Club

North American Big Game Committee
Route #1, Box 147
Salmon, Idaho 83467

Compiles data, keeps records of North American big game taken with bow and arrow in fair chase, conducts biennial competitions and issues awards.

Bowhunters Who Care

P.O. Box 476
Columbus, Nebraska 68601
Individual program for those who endorse bowhunting sportsmanship, love the outdoors, respect wildlife and have an interest in the future role of bowhunting.

The World Archery Center

Marshalls Creek, Pa. 18301
For 40 years, TWAC has been the nation's most complete archery school.

For information write:
Mrs. Edward B. Miller
67 (B) Old Stone Church Road
Upper Saddle River, N.J. 07458

Fred Bear Sports Club

See page 47.

ARCHERY SAFETY

- Shoot only at the target.
- Never shoot up into the air or in any direction where you might destroy property or endanger life.
- Never draw or shoot your bow when anyone is between you and your target.
- Always be sure that the area back of your target is clear.
- Never allow anyone to retrieve arrows until all arrows have been shot.
- Be sure arrows are of the correct length and stiffness for your bow.
- If an arrow has even a small crack, throw it away immediately.
- An archery set is not a toy! Treat it with respect.



Involvement in an organized archery program can help you to increase both your skill and enjoyment of the sport. Listed below are some of the many archery related programs available.

The Presidential Sports Award in Archery—is earned by shooting a minimum of 3,000 arrows (no more than 60 arrows in one day) at a minimum target distance of 15 yards. The qualifying standards of the Presidential Sports Award are designed to assure regularity of participation and an investment of time and effort conducive to physical fitness for those fifteen years or older. Further information, personal log books and qualifying standards are available free from: The Fred Bear Sports Club, Rural Route One, Grayling, MI 49738.

The Archery Merit Badge—is available to members of the Boy Scouts of America upon completion of an archery program of education and skill training. For further information contact: Boy Scouts of America, New Brunswick, New Jersey 08903.

Hunter Safety Programs—provide instruction on Archery and Firearms Safety, First Aid, Game Identification and Survival. Required in many states before you can obtain a hunting license. Excellent information for any archer, bowhunter or not. For further information, contact your State Fish and Game Department.

4-H Club Archery Programs—are available on local and State levels in many areas, providing education, instruction and competition. For further information contact the County Extension Service Agent in your area.



State Archery Organizations (Includes Canada)

- Alabama Archery Association**
1900 Wooten Drive
Birmingham, Alabama 35241
- Bowhunters of Alabama, Inc.**
Route #2
Holly Pond, Alabama 35083
- Arizona Bowhunters Field Archery Association**
1517 E. Coronado Road
Phoenix, Arizona 85006
- Arizona State Archery Association**
1727 W. Verde Lane
Phoenix, Arizona 85015
- Arkansas Bowhunters Association**
P.O. Box 9922
Little Rock, Arkansas 72209
- Arkansas State Archery Association**
23 Deerfield
North Little Rock, Arkansas 72116
- British Columbia Archery Association**
39 8th Street
New Westminster, B.C. V3M 3N7
- California Bowmen Hunters & State Archery Association**
15601 Justin Village Way, Apt. #4
Tustin, California 92680
- State Archers of California**
445 South Dill Soil Lane
Diamond Bar, California 91765
- Colorado State Archery Association**
Rt. #2, Box 541
Eaton, Colorado 80615
- Colorado Bowhunters Association, Inc.**
2085 Nome Street
Aurora, Colorado 80010
- The Connecticut Archery Association**
19 Farland Drive
Huntington, Connecticut 06484
- Delaware State Archery Association**
500 Linden Street
Seaford, Delaware 19973
- Panhandle Bowhunter's Association**
210 Muscogee Road
Cartersville, Florida 32533
- Florida Archery Association**
3029 Northwest 38th Street
Gainesville, Florida 32601
- Florida Bowhunters Council**
1810 Emerson Avenue
Bartow, Florida 33830
- Georgia Bowhunters Archery Association**
Rt. #1, Box 112
Mansfield, Georgia 30255
- Hawaii State Archery Association**
91-506 Oheua Street
Ewa Beach, Hawaii 96706
- Idaho Field Archery Association, Inc.**
Rt. #3
Jerome, Idaho 83338
- Idaho State Bowhunters**
2053 Evans Ave.
Idaho Falls, Idaho 83401
- Illinois Archery Association**
208 East Locust
Channah, Ill. 62629
- Indiana Bowhunters Association**
Route No. 1
Brownstown, Indiana 47220
- Indiana Field Archery Association**
Box 42
Brownsville, Indiana 47325
- Iowa Bowhunters Association, Inc.**
Box 872
Waterloo, Iowa 50704
- Iowa State Archery Association**
829 17th Street SW
Cedar Rapids, Iowa 52404
- Kansas Bowhunters Association**
628 South 5th Street
Salina, Kansas 76401
- Kansas State Archery Association**
P.O. Box 475
Bonner Springs, Kansas 66012
- Kentucky Bowhunters Association**
1429 Longfield Ave.
Louisville, Kentucky 40215
- Louisiana Bowhunters Association**
P.O. Box 4180
Shreveport, Louisiana 71104
- Louisiana Field Archery Association**
5111 Green Ridge
Baton Rouge, Louisiana 70814
- Manitoba Bowhunters**
30 Normande Drive
Winnipeg, Manitoba
R2Y 1H9, Canada
- Maryland Archery Association**
8706 Richmond Avenue
Baltimore, Maryland 21234
- Maine Bowhunters Association**
13 Sherburne Street
Springvale, Maine 04083
- Massachusetts Field Archery Association, Inc.**
123 Coventry Circle
Brocton, Massachusetts 02401
- Michigan Archers Association**
2440 Rebecca Lane
Niles, Michigan 49120
- Michigan Bowhunters Association**
RR #1, Box 402
Onaway, Michigan 49765
- Minnesota State Archery Association**
6941 Zane Avenue No.
Brooklyn Park, Minnesota 55429
- Mississippi Bowhunters Association**
P.O. Box 28
Indianola, Mississippi 38751
- Mississippi State Archery Association**
Rt. #1, Box 599P
Jackson, Mississippi 39212
- Missouri Bowhunters**
P.O. Box 9517
O Fallon, Missouri 63366
- Montana Bowhunters Association**
P.O. Box 837
Three Forks, Montana 59752
- Montana Bowmen, Inc.**
Box 282
Havre, Montana 59501
- Nebraska Prairie Bowmen State Archery Association**
Walt Hill, Nebraska 68067
- New Jersey Archery Association**
Rt. #1, Box 294
Cape May, New Jersey 08204
- United Bowhunters of New Jersey**
P.O. Box 204C
Midland Park, New Jersey 07432
- New Jersey State Field Archery Association**
503 E. Main Street
Somerville, New Jersey 08876
- New Mexico Bowmen**
P.O. Box 4525
Albuquerque, New Mexico 87106
- New Mexico Bowhunters Association**
1213 Indiana
Alamogordo, New Mexico 88310
- New York Archery Association**
79 Martin Court
Jericho, New York 11753
- New York Field Archery Association**
4533 Ontario St. Ext.
Catskill, New York 14824
- North Carolina Archery Association**
5828 Lehigh Road
Charlotte, North Carolina 28212
- North Carolina Bowhunters Association**
750 Vickery Drive
Charlotte, North Carolina 28215
- North Dakota Bowhunters Association**
Box 503
Bismark, North Dakota 58501
- Ohio Archers**
3677 Watt Road
Gahanna, Ohio 43230
- Oklahoma State Archery Association**
434 Highland Drive
Bartlesville, Oklahoma 74003
- Oklahoma Archers Association**
1500 N. Villas
Guthrie, Oklahoma 74044
- Oregon Bowhunters, Inc.**
P.O. Box 2422
Eugene, Oregon 97402
- Pennsylvania Professional Bowhunters Society**
Rt. #2, Box #89
Middlebury Center, Pa. 16935
- Pennsylvania State Archery Association**
102 Dewey Avenue
Pittsburgh, Pennsylvania 15223
- Saskatchewan Provincial Bowhunters**
6 Lorimer Cres
Regina, Saskatchewan, Canada
- South Carolina Archery Association**
Box 509
Clemson, South Carolina 29631
- South Dakota Archery Association**
720 E. 4th Street
Sioux Falls, South Dakota 57103
- Lone Star Bowhunters Association**
Rt. #1, Box 404
Hempstead, Texas 77445
- Texas Field Archery Association**
5725 Sunset Road
Fort Worth, Texas 76114
- Utah Bowmen's Association**
9959 Aster Lane
Sandy, Utah 84070
- Vermont Bowmen**
28 Highland Street
Brattleboro, Vermont 05301
- Virginia Bowhunters Association**
Rt. #1, Box 215
Strasburg, Virginia 22657
- Washington State Archery Association**
3911 NE 140th St.
Seattle, Washington 98125
- West Virginia Archery Association**
Sandy Height
Pt. Pleasant, West Virginia 25550

WORLDWIDE ARCHERY

The worldwide governing body for the sport of archery is the Federation International De Tir A L'Arc (FITA). This distinguished group oversees all International Competition including the Olympics. The F.I.T.A. representative here in the United States is the National Archery Association. If you live in another country and would like to learn more about the sport of archery, we suggest you contact the F.I.T.A. representative in your country. The members of F.I.T.A. include the following:

ARGENTINA:
Asociacion Argentina De Tiro Con Arco
El Fogon 4422
Buenos Aires
Argentina

AUSTRALIA:
Archery Association of Australia
P.O. Box 33
Melville 6156
W. Australia
Australia

AUSTRIA:
Osterreichische Bogenschuetzenverband
A-4822 Bad Goisern 189
Austria

BELGIUM:
Federation Royale Belge De Tir A L'Arc
Biesmanslaan 15
B-1990 Hoeilaart
Belgium

BRAZIL:
Confederacao Brasileira De Desportos
Rua da Alfandega 70
Edificio J. Havellange
Casa Postal 1078
2000 Rio De Janeiro
7C-00-GB, Brazil

CAMBODIA:
Federation Cambodgienne De Tir A L'Arc
98 Vithei Dekcho
Damdin, Phnom-Penh
Cambodia

CANADA:
Federation of Canadian Archers
2677 Dunlevy St.
Victoria B.C.
Canada

COLOMBIA:
Colombiana De Tiro Y Caza
Diagonal 40
No. 47-75 of 207
Apartado Aereo 80035
Bogota, Columbia, S.A.

COSTA RICA:
Costa Rican National Archers Association
Apartado 1989
San Jose,
Costa Rica

CUBA:
Union Atletica De Amateurs De Cuba
%Hotel Habana Libre
L and 23 Street
Habana, Cuba

CYPRUS:
The Cyprus Archery Federation
P.O. Box 1384
Nicosia, Cyprus

CZECHOSLOVAKIA:
Czechoslovak Archery Association
Na Porici 12
11530 Prague 1
Czechoslovakia

DENMARK:
Dansk Bueskytforbund
Kaalmarken 8
DK-2860 Soborg
Denmark

DOMINICAN REPUBLIC:
Federation Dominicana De Arqueros
P.O. Box 1191
Santo Domingo
Dominican Republic

EGYPT:
Federation De Tir De La Republique Arabe D'Egypte
37 Rue Abou Klakel Sarwat
P.O. Box 290
Cairo, Egypt

IRELAND:
Irish National Archery Federation
103 St. Brendans Ave.
Malahide Road
Dublin 5, Ireland

FINLAND:
Suomen Jousiampujain Liitto
Finnlands Bogskytteforbund
Mannerkatu 2
00170 Helsinki 17
Finland

FRANCE:
Federation Francaise De Tir A L'Arc
14 Boulevard Ornano
75018 Paris, France

GERMANY:
Deutscher Schutzenband e.V.
Klarenthaler Strasse
62 Wiesbaden-Klarenthal,
Germany
Deutscher Bogenschutzen Verband der DDR
Schulzendorferstr. 5
11003 Eschwege Berlin
German D.R. (DDR)

GREAT BRITAIN:
Grand National Archery Society
N.A.C.
Stoneleigh
Kenilworth CV8 2LG
Warwicks, England

HOLLAND:
Nederlandse Handboog Bond
Tetterodesstraat 35
Haren
Holland

HUNGARY:
Magyar Ijasz Szovetsseg
Rosenberg hzp-u 1.
Budapest V, Hungary

INDIA:
Archery Association of India
23 Darya Ganj,
Delhi-6, India

INDONESIA:
Persatuan Panahan Indonesia
Perpanti Koni Building
Pinto 1 Stadium
Utama-Semayan
Jakarta, Indonesia

ISRAEL:
The Israel Amateur Archery Association
P.O. B. 286
Ramat, Gan,
Israel

ITALY:
Federazione Italiana Di Tiro Con L'Arco
Via Visconti Di Modrone 19
20122 Milan
Italy

JAPAN:
All Japan Amateur Archery Association
1-1-1 Ohmei Jinnan
Shibuya-ku,
Tokyo, Japan

JORDAN:
The Royal Archery Association of Jordan
P.O. Box 920
Amman, Jordan

KOREA:
Archery Association of the D.P.R. of Korea
Dongsin 2,
Dongdaewon District
Pyongyang,
D.P.R. Korea

Korean Archery Association
19 Mukyo-Dong
Chung-Ku
Seoul, Korea

LUXEMBOURG:
Federation Luxembourg De Tir A L'Arc
214, Rue de Reckenthal
Luxembourg G.D.

MALAYSIA:
National Archery Association of Malaysia
15 Kenny Pertama
Kuala Lumpur 11-02

MALTA:
The Archery Association of Malta
4, Shalimar Court
Naxos Falcon Street
Msida, Malta

MEXICO:
Federacion Mexicana De Tiro Con Arco
Pradera 85
Jardines del Pedregal
Mexico 20 D.F.

MONACO:
Federation Monegasque De Tir Section Arc
188 Route de St. Pierre de Ferrie
06000 Nice, France

MONGOLIA:
Mongolian Archery Federation
Baga Toirgot 55
Ulan-Bator
Mongolia

MOROCCO:
Federation Marocaine De Tir A L'Arc
7, Zenkat Beyrouth
B.P. 24
Meknes, Morocco

NEW ZEALAND:
New Zealand Archery Association
37 Tenynson Avenue
Lower Hutt,
New Zealand

NORWAY:
Norges Bueskytforbund
Box 30, Holmen,
Oslo 3,
Norway

THE PHILIPPINES:
National Archery Association of the Philippines
P.O. Box E-A-132 Ermita,
Manila, 2801
Philippines

POLAND:
Federation Polonaise De Tir A L'Arc
126a Czerniakowska St
00-454 Warsaw,
Poland

PORTUGAL:
Federacao Portuguesa De Tiro Ao Arco
Rua Do Arco, Do Cego 90-5
Lisbon 1, Portugal

PUERTO RICO:
Federacion De Arqueros De Puerto Rico, Inc.
G.P.O. Box 506
San Juan,
Puerto Rico 00936

RHODESIA:
Rhodesian Archery Association
4 Posselt Road,
North End,
Bulawayo, Rhodesia

SINGAPORE:
Archery Association of Singapore
93B Prince Charles Crescent
Block 69, Singapore, 3

SOUTH AFRICA:
South African National Archery Association
58 Umgeni Road
Farrarmere
Benoni, 1500
Transvaal
South Africa

SPAIN:
Federation Espanola De Tiro Con Arco
Naves de Babos 13,
Madrid 1, Spain

SWEDEN:
Svenska Bogskytteforbundet
P.O. Box 32
196 21 Kingsangen
Sweden

SWITZERLAND:
Association Suisse De Tir A L'Arc
Av. du Tir Federal 38,
1024 Ecublens,
Switzerland

TAIWAN:
Republic of China Amateur Archery Association
Ming Sheng E. Road
Taipei, Taiwan-R.O.C.

THAILAND:
National Archery Association of Thailand
P.O. Box 2/70
Bangkok,
Thailand

TURKEY:
Federation Turcaue De Tir A L'Arc
Ankara, Turkey

UNITED STATES:
National Archery Association
1951 Geraldson Drive,
Lancaster,
Pennsylvania 17601

U.S.S.R.:
U.S.S.R. Archery Federation
Skatertnyi Pereulok 4
Moscow 69, U.S.S.R.

VENEZUELA:
Federation Venezolana De Tiro Con Arco
Av. Ginebra Gta. Los Nikis,
California Sur Petare,
Venezuela

YUGOSLAVIA:
Yugoslavian Archery Association
Klanjec 15,
Zagreb, Yugoslavia

F.I.T.A. WORLD HEADQUARTERS:
Le Siege De La F.I.T.A.
46 The Balm
Wotton, Wakefield
WF2 6JU England

WHY YOU SHOULD JOIN THE FRED BEAR SPORTS CLUB!

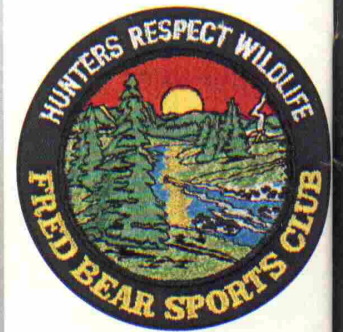

Back the people who are doing more than just talk about the anti-hunters.

Help us Save Hunting And Fishing And At The Same Time Benefit Our Wildlife!

If you want to continue and if you want your children and grandchildren to enjoy fishing, hunting and watching wildlife then you must do more than just talk about it. You must take action today! The Fred Bear Sports Club is an action-oriented group of dedicated people who believe in doing, rather than just talking.

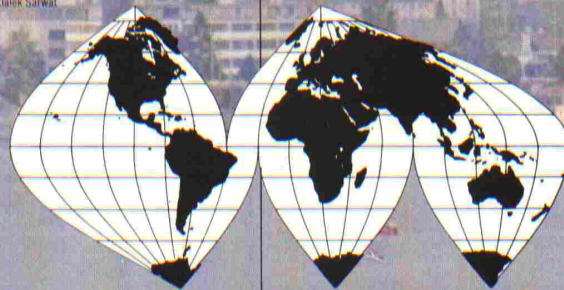

We and the NFAA (National Field Archery Association) are about the same size and are the largest organizations in our sport of archery. We both have in excess of 20,000 members out of a total number of U.S. bowhunters of about 1,200,000. The NFAA was founded in 1939 and is a highly structured state by state organization that is doing excellent work in selected areas such as wildlife education (see posters on this page), bowhunting education and the legal defense of bowhunting. The Fred Bear Sports Club, founded in 1972, complements this work by involving itself on a national basis in our strong suit of movies, television and advertising. Some samples of our current efforts in your behalf are also shown below. In the past 5 years The Fred Bear Sports Club has invested over \$500,000 on special projects such as these to help propagate hunting, fishing and scientific wildlife management and to refute the irresponsible actions and results of the anti-hunting groups. Your \$5 membership goes into this kitty. About \$3.17 of your \$5 goes for your membership kit materials. We are sure you can see that we are investing a considerable amount of money over and above what our limited membership generates. But we need your name and commitment to our cause. Washington and your State Legislature listens to organized groups of people. Join such a group. Join The Fred Bear Sports Club today!

Care About America's Wildlife. We Do.

Send money to the Fred Bear Sports Club for your membership kit materials. We are sure you can see that we are investing a considerable amount of money over and above what our limited membership generates. But we need your name and commitment to our cause. Washington and your State Legislature listens to organized groups of people. Join such a group. Join The Fred Bear Sports Club today!

These two advertisements were created and produced by The Fred Bear Sports Club for the International Association of Fish & Wildlife Agencies (your state DNR is a member). We are placing them nationwide. The first of a continuing series.

Care About America's Wildlife. We Do.

There are only 900 breeding pairs of Bald Eagles in the lower 48 States. Help us protect them.

We have also produced outdoor billboards for the I.A.F.W.A. that are available for national use. Ask your local outdoor billboard company to donate the space as a public service. We can provide them with reproduction materials. Tell them to write or call us here in Grayling, Fred Bear Sports Club, Rural Route One, Grayling, Michigan 49738 Phone 517-348-6011.

Care About America's Wildlife. We Do.

International Association of Fish & Wildlife Agencies

WHITETAIL DEER (Odocoileus virginianus)

RANGE AND HABITAT:

- Most areas of food and shelter for American white-tailed deer.
- In 1970 there were over 100,000 white-tailed deer in the United States.
- The deer is found in most states and is common in the Northeast, Midwest, and South.
- Deer are found in most states and are common in the Northeast, Midwest, and South.
- Deer are found in most states and are common in the Northeast, Midwest, and South.

CHARACTERISTICS:

- Deer are found in most states and are common in the Northeast, Midwest, and South.
- Deer are found in most states and are common in the Northeast, Midwest, and South.
- Deer are found in most states and are common in the Northeast, Midwest, and South.

IDENTIFICATION:

- Deer are found in most states and are common in the Northeast, Midwest, and South.
- Deer are found in most states and are common in the Northeast, Midwest, and South.
- Deer are found in most states and are common in the Northeast, Midwest, and South.

HABITAT IS THE KEY TO WILDLIFE SURVIVAL

This material was prepared by a wildlife biologist and is available for educational purposes. For more information, contact the International Association of Fish & Wildlife Agencies, P.O. Box 2954, Washington, D.C. 20013.

We have donated a considerable amount of money to the NFAA to get this very important Wildlife Education Poster program they have developed off the ground. These are aimed primarily at school children and are superbly done. We urge you to purchase these poster sets with accompanying classroom material and donate them to your local schools. Cost is \$4.00 each. Send check or money order to American Wildlife Education Foundation, Route 2, Box 514, Redlands, California 92373.



We have just completed over two years of filming on "The Good Earth" a half-hour film dealing with hunting, fishing, hiking, nature photography, camping and the like to show man's true relationship in all its facets to the outdoors. The film stars Fred Bear and Astronaut James A. Lovell, Jr. and is tied into The President's Council on Physical Fitness and Sports. It will be televised and distributed nationally.

The "American Outdoors" television series has been financed by your Fred Bear Sports Club, the National Rifle Association and the Archery Manufacturers Organization. It is in the process of being distributed nationally. If you would like it to run in your market, talk to your local television station manager and have him contact Fred Bear Sports Club, Rural Route One, Grayling, Michigan 49738 Phone 517-348-6011.

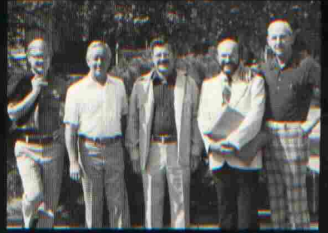

"America's Wildlife" is another television series under development and is being produced in cooperation with the International Association of Fish & Wildlife Agencies. It will air in the near future. Shown during a recent production review session in Washington, D.C. are, left to right: Phil Million, Television Chief, U.S. Fish & Wildlife Service; Francis Satterlee, Virginia Commission of Game & Inland Fisheries; Dick Lattimer, Executive Director, The Fred Bear Sports Club; William Goudy, IAFWA Television Subcommittee Chairman and Dr. John Gottschalk, Executive Director, IAFWA and former Director of the Bureau of Sport Fisheries and Wildlife, Department of Interior, under Presidents Johnson and Nixon. All 50 state DNR's are providing input for this new series and America's top names in wildlife management are intimately involved in its conception and production.

AMERICA'S WILDLIFE NEEDS YOUR HELP

Your contribution to A.W.A.R.E. (America's Wildlife Association for Resource Education) can help us produce and broadcast the truth about North American Wildlife and Fisheries Management. This is a new Foundation just established by our 50 State Fish and Game Agencies, the Canadian Provinces and Mexico to help educate the non-hunting public.

This is the opportunity that all American hunters and fishermen have been waiting for. Send your check or money order immediately to: A.W.A.R.E., P.O. Box 2954, Washington, D.C. 20013

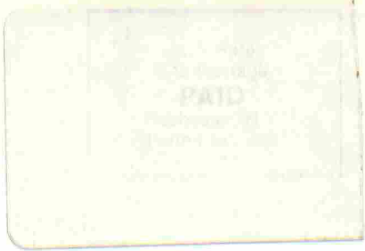

NEW FOR 1978

Featuring the New Bear Temujin II[®] and Kodiak Special[®] Compound Bows, Metric Hunter[™] Arrows and the New Bear Super Razorhead[®].

Super Razorhead—Factory sharpened superior hunting heads, chisel pointed with edges honed to a razor like finish. Edge protected with a plastic coating. Super-sharp and may be resharpened after use. See pages 29 and 38.

Metric Hunters—Our new economy aluminum hunting arrows designed for Compound and Conventional Recurve bows. Good price, with Weathers[™] fletching and Polysulfone Converta-point inserts for non-corrosive point attachment. For the whole story see pages 28 and 30.



Bear Temujin II[®]—Our newest tournament Compound bow, featuring six-position weight adjustment and 30-33% let-off. Weight is adjustable over a range of 25 lbs. (11.25 kg.) for use shooting indoors or out. See it on page 8.



Bear Kodiak Special[®]—Our new super-shooting 2-wheel Compound bow with laminated hard-rock maple and fiberglass[®] limbs. Available in three different draw lengths, this bow features 10 lb. (4.5 kg.) weight adjustment and a 50% let-off. For more, see page 11.



Member Archery
Manufacturers Organization

BEAR ARCHERY

Subsidiary of Walter Kidde & Company, Inc.

KIDDE

Rural Route One
Grayling, Michigan 49738
(517)346-6011

Copyright © 1977 Bear Archery Printed in the United States of America