



# Bear Archery 1974

*Stalking the mighty grizzly,  
British Columbia, 1963, for a  
Life Magazine article.*



## Dedication

This catalog introduces a fresh new look to archery equipment and is dedicated to a small Pennsylvania farm boy, who after learning to hunt with a gun by his father's side in the mountains and fields of Cumberland Valley, went on to become the world's foremost living authority on the bow and arrow. By his life style he has set a high standard of conduct and respect for the great out-of-doors throughout the world for all to emulate. This catalog is dedicated to Fred Bear by the members of The Fred Bear Sports Club.

### Bear 1974

The Fred Bear Sports Club has just been introduced to the American public. This is the culmination of Fred's lifetime attempt to establish a Code of Ethics for all who enjoy the outdoors to follow. There is more on this unique Club on page 46. Briefly, though, members of the Fred Bear Sports Club are pledged to preserve the ecology of our woods, fields and waters and to support proper wildlife management. They must further pledge to uphold the Fish and Game laws to which they are bound, the preservation of our natural resources and the honest fulfillment of the restrictions under which they compete in all outdoor sports. Members must pledge to observe the Rules of Fair Chase in all of their outdoor activities.

As you review the products in the following pages you will be struck with the unusually attractive colors of this new line of bows. Our new 1974 Bear<sup>®</sup> bows reflect this reverence for the nature around us that we are trying to help preserve. You will see the brilliant blues of fresh waters and clear skies, the warm bark browns of the mighty trees of the forest, the rich greens of the fields and ferns and the striking reds of sunset. And, then, in honor of all that this great country has given to Fred Bear and to Bear Archery you will meet the Bear '76er<sup>™</sup> and the Victor Patriot<sup>™</sup> bows, bold blendings of the colors of Old Glory.

12 year old Fred Bear with his dog, Scot.

2



### Fred Bear, the man.

Last summer, during the week of the PAA Nationals the Tournament of Champions and the Olympic Qualifying Tournament the Archery Hall of Fame was introduced. The first inductees for this honor were Howard Hill, Ben Pearson, Ann Weber Hoyt, Maurice Thompson, Russ Hoogerhyde, Karl Palmatier and Fred Bear. Fred's plaque reads "His pioneer work in the art of archery manufacture is matched only by his worldwide contributions to the art of bowhunting."

Behind this one sentence describing the life of a man is a Horatio Alger story worthy of others the likes of Henry Ford, Thomas Edison, George Westinghouse, and other pioneers of the American scene. This is not a biography, it is a commercial catalog, but to understand the quality and craftsmanship built into each and every Bear Archery product, one must first understand the man who insists upon this quality and establishes this craftsmanship. His great devotion to detail has earned Bear products the highest accolades the world over. It was instilled in him by his parents on their farm in Pennsylvania. Even as a youngster running a trap line to earn pocket money Fred would take his hard earned dollars



home to his room and iron them so that they would be neat and in proper order. This same attitude was carried over to the extremely critical eye that patternmaker Fred Bear brought to Detroit in the 20's. He was attracted to the almost virgin hunting territories of northern Michigan as well as the automotive industries of that state. In 1927 he saw a movie made by the late Art Young (of Pope & Young) on bowhunting in Alaska and was immediately intrigued. Fred Bear, the patternmaker turned Fred Bear, the bowyer. His first bow was made of Lemonwood. And he taught

In the Porcupine Mountains, Upper Peninsula, MICHIGAN 1933

George Farling and Fred Bear at age 14. PENNSYLVANIA 1916.

himself to shoot it, so well, in fact that in the 30's he made a name for himself in both indoor and outdoor archery tournaments across the state of Michigan. In 1933 he started making equipment for his friends in his home in Detroit and began his lifelong effort to bring archery back into prominence in the world of sports. Since the 1906 Olympics, it had fallen into hard times

with few participants. Fred was instrumental in having the first bowhunting season established in Michigan in 1937. Along with his love of tournament archery grew his thrill of the challenge of hunting with the bow and arrow. He had taken the biggest buck he had ever downed to that time with a rifle and found it to be too easy. He accepted the challenge of the relatively short range of the bow where most shots are usually less than 40 yards and where great hunting

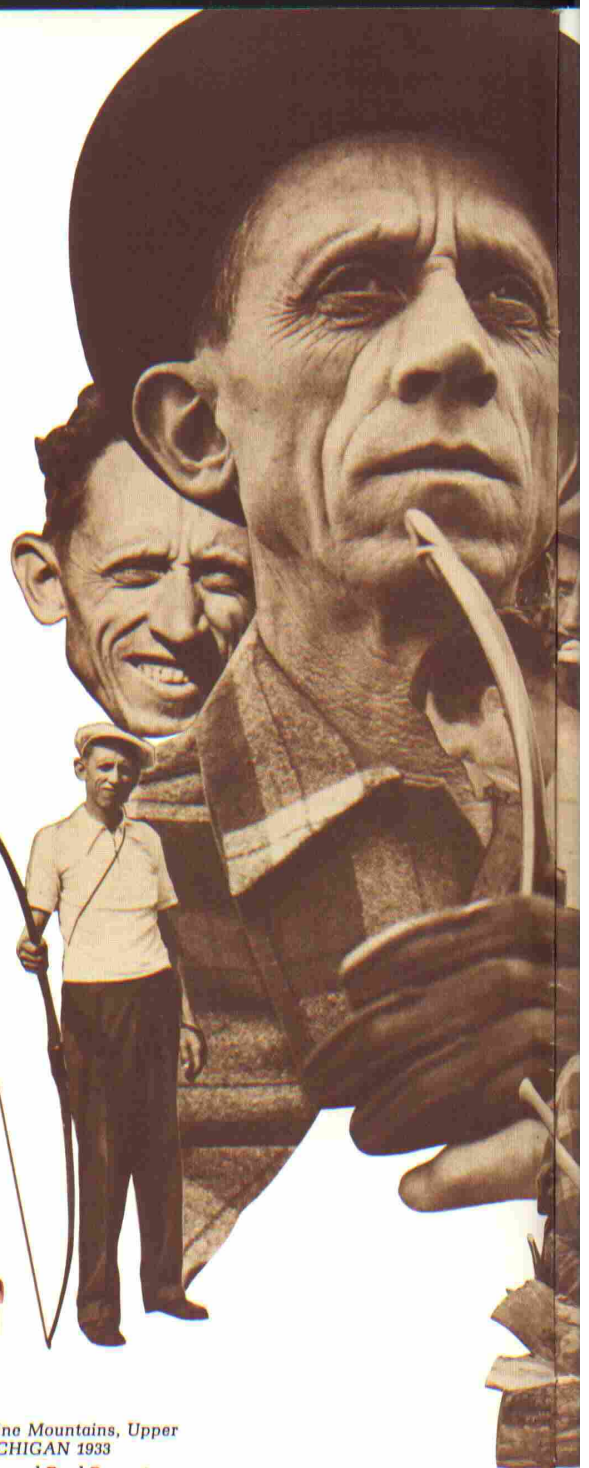





midnight horseback ride mixed in with high spirits and high jinxs, Fred selected the site for his factory on the banks of the beautiful Au Sable river on the edge of the tiny village of Grayling.

Fred Bear is truly a pioneer. He is directly responsible for the development of many of the designs and manufacturing processes utilized by virtually all present-day makers of high quality archery equipment. Moreover, it was his creativity and determination that made possible the mass production of bows and arrows. His patents, covering both methods and materials, have in one way or another benefited almost all of today's bow makers because he has never sought royalties from competing firms. Rather, he has always maintained that what was good for the industry as a whole would be good for his business as well. A dramatic

*Aboard the Valiant Maid, Cordova, ALASKA 1959*

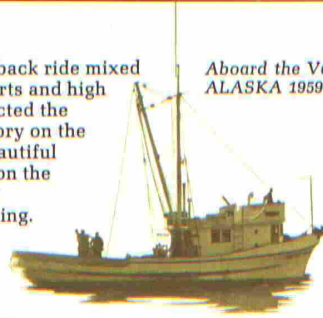

illustration of the meaningful attitude he held toward his patents is the modern composite bow. Fred holds patents covering design, materials, and manufacturing methods relating to this type bow. The fruits of such creative labors have been shared freely. Just a few of Fred Bear's firsts are:

1. First use of high compression materials in bowmaking. Since the middle ages men had searched for materials to duplicate the power and reliability of the ancient Turkish bows whose bowyers had taken their secret to the grave with them. Fred Bear found it by combining fiberglass and exotic hardwoods.
2. First bowsights to become an integral part of a bow's design.
3. First built-in, adjustable arrow plate.

*Fred Bear at various stages of his career from a 1937 target shoot with the Detroit Archers to his 1959 trip to the Little Delta in Alaska.*

skills must be developed to get within that range. Much of Fred's early bow hunting was done in the beautiful Au Sable River valley of the Northern Michigan lower peninsula. And so it was to that area that he decided to move his manufacturing facilities shortly after World War II. He freely admits that it was done to be near the fabulous hunting and fishing found there. After a hilarious





4. Invented the bow quiver as an aid to hunters stalking thru heavy brush. The traditional back or belt quiver is troublesome under normal hunting conditions. Fred discarded his, carrying his arrows first in his hands. Then he struck upon the idea of crafting a groove into the back of his bow handle, a slot into which his spare arrow would fit. Finally he came up with a hand held quiver with which he could maneuver around obstacles. (see page 29). The logical next step was for Fred to attach this quiver directly to the bow with a protective cover for his hunting heads. Thus was born the bow quiver.

5. The Bear Razorhead is the most famous and most used hunting head in the world today. It was developed by Fred to insure bringing the game down as quickly and humanely as possible. Rather than having just two cutting surfaces as have been used since Stone Age man Fred added a replaceable insert into the main blade giving the hunting head four cutting surfaces. This humane effort has been very effective.

6. The truest measure of the creativity brought by a designer to his work is to look at even the simplest item, such as a nail, and be able to improve upon it after careful study of the object, its environment, its limitations and its purpose. Fred studied the arrow. He already had improved the arrowhead but the basic principle of the arrow had remained the same for millenia. The shaft was permanently attached to the arrowhead. The archer needed one arrow for hunting big game, another for field archery and a third for small game and stump shooting. Fred's Answer? The new Converta-Point Arrow. A unique idea permitting the instant removal of one head for the substitution of another. Suddenly one arrow became three arrows. The hunter could use blunts, field points or razorheads all on the same shaft. The 3 in 1 arrow was a reality. A wonder shaft, X-7 aluminum, was added to this revolutionary new head for the resultant ultimate arrow.

7. The way that Fred Bear has helped build the sport of archery from relative obscurity to its current high level of popularity, approximately the same participant level as golf, was by traveling around the world, field testing his many archery inventions and innovations under the most trying and punishing conditions. Fred literally gambled his life many times on his

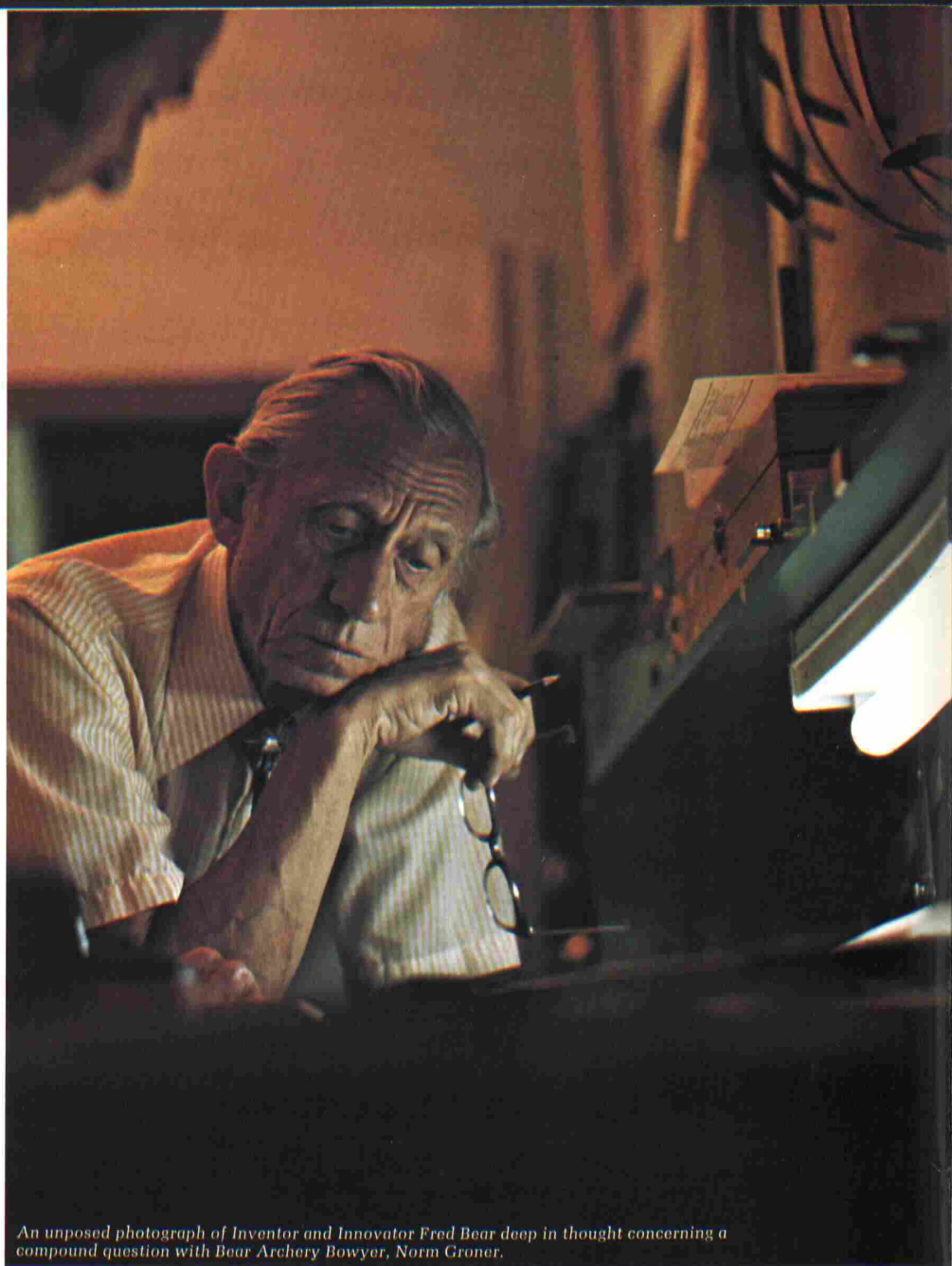

*An unposed photograph of Inventor and Innovator Fred Bear deep in thought concerning a compound question with Bear Archery Bowyer, Norm Groner.*

equipment. He felled a bull elephant with one arrow. He had proven his equipment on all of the major big game animals of the world. But in all of this traveling he had one constant problem. His bow was cumbersome. It was too long and could be easily damaged by careless freight handlers. It is critical to the success of any hunt that the major piece of equipment, the bow, arrive in top shape. So, in 1947, Fred invented a take down bow. But he was not satisfied with it. For while he had invented a solution, he had not perfected it to his extremely high standards. And so, he never put it

on the market. But he continued to fiddle with it. And to study it. His goal was a true take-down bow, one easy to assemble and take apart like a fine gun, not just a take apart bow requiring tools and time. In the meantime his competitors introduced a take-apart bow, seemingly stealing the thunder from Fred. Still he wouldn't bring out his bow. He is a patient man. And he is a man who will not put his name on a product that does not meet his standards. Finally, in 1967, after twenty years of experimenting, Fred Bear found the ultimate answer to the Take-Down bow. A

bow that could be taken apart quickly and hand carried in a briefcase sized protective covering. But, it would be three more years before Fred permitted his bow to be offered for sale to the public. First, he must test it under the most trying of terrain in the high country of Alaska, the jungle growth in the Amazon and in Africa. It proved its mettle on game of all sizes on these three continents. Fred Bear had invented and perfected the ultimate Take Down bow.



## Fred Bear Take-Down Bows

With the Bear Take-Down, you shoot tournaments and trophies with one bow instead of two. Change limbs and you're ready to go from the field to the tournament line.

Just insert perfectly-matched Bear limbs into the handle and they're locked into place for precision shooting. They cannot rattle or move. Machined grooves in the limbs and matching limb microgroove alignment key in the handle's socket hold the limb securely in place for perfect fit and alignment each time. No tools are required. Hardware—latches, yokes, and clamps—is made of steel. Like a fine gun. Shoot trophies in the morning, tournaments in the afternoon—with one bow instead of two. The Bear Take-Down.



### Secure

Close-up of the limb inserted into the handle section. They are held securely together by the clamp latch and release clip.



### Easy

Opened handle socket showing limb alignment key and stop screw.

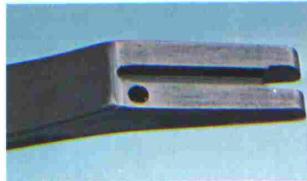

### Perfect fit

The back of each limb is machined with a locator pinhole and limb microgroove alignment keyway.

The locator pin and pinhole match for perfect fit and positive limb alignment.

Upper and lower limbs cannot be reversed, insuring proper designed balance.



### 6100-6105 Hunting Sight

The Bear Field Model Premier hunting sights were designed specifically for the Victor Kodiak and Victor Magnum all-purpose sport bows on this page. By presetting a different yardage into each of three fluorescent rings, you can shoot from three known distances without changing your sight.



### 2200 Kodiak® Adjustable Arrow Plate

The Kodiak® Adjustable Arrow Plate makes tuning this bow easy. Just adjust a simple set screw to increase or decrease your center shot.



### 2182 Chrome Yoke and Latch

Another unique Bear feature is the chrome-plated yoke and latch for your magnesium Take-Down handle. It's available at slight additional cost.

### Take-Down Bow Limbs

Only Bear limbs are Fascor™ powered for speed and stability. They're Fiberglas® laminated on both sides and triple reinforced at the tips with Bearglas®.

Each pair is perfectly balanced and matched to perform as a unit. In three different lengths, interchangeable on all take-down handles.



The Victor magnesium Take-Down bow handles are available in eight colors, ranging from subdued camo colors, perfect for hunting, to brilliant hues to make your bow the most noticeable at any range.

Masai Brown



Arctic White

Bundi Black

Little Delta Green

Yukon Yellow

Kispiox Blue

### 2181 Magnesium Bow Handle Grips

You have a choice of three different handle grips. Made of non-slip vinyl, the grip is simple to install. Standard pistol grip is standard equipment on all magnesium handle Take-Downs.

To order specify grip size, right or left hand.

No. 1 Standard Pistol. Also available in Red, White or Blue, right hand only.  
No. 2 Medium Pistol. Black only.  
No. 3 High Pistol. Black only.



No. 1

No. 2

No. 3

### HOW TO ORDER TAKE-DOWN BOWS

Refer to this chart for the proper match up of the handle section and the color limbs that you want. To order, please specify the combination Order Number shown in the right hand column. Be sure to mention the handle color and draw weight you want along with this Order Number.

Bow Handle	Catalog Number	Length	Limbs	Order Number
Victor Viking	2180	66"	Black-2171	2180-2171
Victor Viking	2180	66"	White-2107	2180-2107
Victor Viking	2180	68"	Black-2172	2180-2172
Victor Viking	2180	68"	White-2108	2180-2108
Victor Viking	2180	69"	Black-2173	2180-2173
Victor Viking	2180	69"	White-2109	2180-2109
Victor Kodiak	2179	60"	Black-2171	2179-2171
Victor Kodiak	2179	60"	White-2107	2179-2107
Victor Kodiak	2179	62"	Black-2172	2179-2172
Victor Kodiak	2179	62"	White-2108	2179-2108
Victor Kodiak	2179	64"	Black-2173	2179-2173
Victor Kodiak	2179	64"	White-2109	2179-2109
Victor Magnum	2178	56"	Black-2171	2178-2171
Victor Magnum	2178	56"	White-2107	2178-2107
Victor Magnum	2178	58"	Black-2172	2178-2172
Victor Magnum	2178	58"	White-2108	2178-2108
Victor Magnum	2178	60"	Black-2173	2178-2173
Victor Magnum	2178	60"	White-2109	2178-2109
Victor Custom Viking	2177	66"	Black-2171	2177-2171
Victor Custom Viking	2177	66"	White-2107	2177-2107
Victor Custom Viking	2177	68"	Black-2172	2177-2172
Victor Custom Viking	2177	68"	White-2108	2177-2108
Victor Custom Viking	2177	69"	Black-2173	2177-2173
Victor Custom Viking	2177	69"	White-2109	2177-2109



## Victor Viking™

### Catalog No. 2180

The finest tournament bow in America today has proven itself under the stiff competition on the Professional Archers Association tour. Early in 1972 Vic Berger equaled his own U.S. Open record by shooting just one point off perfect in his three consecutive rounds, scoring 899 out of a possible 900 in the big Las Vegas tournament. He followed that up in the summer of 1972 by winning the PAA Nationals in Grayling, breaking the previous all time record by better than nine points and becoming only the second man in history to win this National Championship three times. Victor Berger shoots a Victor Viking!

The Victor Viking handle section is made of Space Age Magnesium to Fred Bear's precise specifications. And even though magnesium is more expensive than most other materials, it provides a much lighter and stronger bow and for that reason is the choice of a growing number of tournament shooters.

**Standard equipment** Bristle Rest, Adjustable Nylon Arrow Plate, Sight Plate for 7" Premier Bowsight, Converta-Accessory Insert, three additional stabilizer inserts on face. Will accept Bear-Jeffery Omni-Bowsight on face or back, and the Berger Button. Also includes chrome yoke and latches, Standard Pistol Grip.

**Accessory equipment:** Bear-Jeffery Omni-Bowsight, Berger Button, Magnetic Arrow Rest, 7" Premier Bowsight, Converta-Bowfishing Reel, Bear Hunting Stabilizer, Omni-Coupler® Stabilizer, Bear Take-Down Bow Travel Case,

Medium Pistol Grip, High Pistol Grip. No. 7105 Professional Dacron® String with monofilament serving. See page 5 on how to order Fascor™ powered limbs.

**AMO length:** 66", 68", 69".

**Weights:** 25 to 50 lbs.

**Draw limit:** Unlimited.

**Handle section:** Magnesium.

**Handle color:** Available in Little Delta Green, Bundi Black, Masai Brown, Mozambique Red, Yukon Yellow, Kispiox Blue and Artic White. Weighed at 28" from front of arrow shelf.

**Catalog No. 2180** (Handle section only)

**To order specify:**

1. handle section catalog number
2. handle color
3. right or left hand

"Victor" take down handles are covered by U. S. Patents #2,842,113, #D-204,065, #3,415,241, #3,502,063.

Bear® glass and wood laminated bows are covered by U.S. Patent #2,842,113.

## Victor Kodiak®

### Catalog No. 2179

It's two bows for the price of one! A medium length sight window makes this Magnesium bow equally at home on the shooting line or on the hunt. This is one of the bows Fred Bear hunted with last fall in Alaska. Need we say more?

**Standard equipment** Vinyl Arrow Rest, Kodiak® Adjustable Arrow Plate, Converta-Accessory Insert. Routed for 5" Bear® Field Model Hunting Bowsight, Standard Pistol Grip.

**Accessory equipment:** Bear Hunting Stabilizer, Bear Omni-Coupler® Stabilizer, Bear Converta-Quiver, Bear Converta-Bowfishing Reel, 5" Bear Hunting Sight, Medium Pistol Grip, High Pistol Grip, Bear Master Bowcase. No. 7050 Universal Temper Strand Black Dacron® Bowstring. See page 5 on how to order Fascor™ limbs.





AMO length: 60", 62", 64".

Weights: 25 to 70 lbs.

Draw limit: Unlimited.

Handle section: Magnesium.

Handle color: Available in Little Delta Green, Bundi Black, Masai Brown, Mozambique Red, Yukon Yellow, Kispiox Blue and Artic White. Weighed at 28" from front of arrow shelf.

Catalog No. 2179 (Handle section only)

To order specify:

1. handle section catalog number
2. handle color
3. right or left hand

(Note: Victor Kodiak may be ordered with chrome yoke and latch for slight additional charge.)

## Victor Magnum®

Catalog No. 2178

Tough. Light weight, Magnesium handle. And a real straight shooter. The handle can't warp, crack or check. With a new indestructible Ironwood™ finish — this one can really take it. Take it on your next hunt.

Standard equipment Vinyl Arrow Rest, Kodiak® Adjustable Arrow Plate, Converta-Accessory Insert. Routed for 3/4" Bear® Field Model Hunting Sight, Standard Pistol Grip.

Accessory equipment: Bear Hunting Stabilizer, Bear Converta-Quiver, Bear Converta-Bowfishing Reel, 3/4" Bear Field Model Hunting Sight, Medium Pistol Grip, High Pistol Grip, Bear Master Bowcase. No. 7050 Universal Temper Strand Black Dacron® Bowstring. See page 5 on how to order Fascor™ limbs.

AMO length: 56", 58" 60".

Weights: 25 to 70 lbs.

Draw limit: Unlimited.

Handle section: Magnesium.

Handle color: Available in Little Delta Green, Bundi Black, Masai Brown, Mozambique Red, Yukon Yellow, Kispiox Blue and Artic White. Weighed at 28" from front of arrow shelf.

Catalog No. 2178 (Handle section only)

To order specify:

1. handle section catalog number
2. handle color
3. right or left hand

(Note: Victor Magnum may be ordered with chrome yoke and latch for slight additional charge.)



Victor Viking Catalog No. 2180  
Available at Qualified Bear  
Archery Service Dealerships

Victor Kodiak® Catalog No. 2179  
Available at Qualified Bear  
Archery Service Dealerships

Victor Magnum® Catalog No. 2178  
Available at Qualified Bear  
Archery Service Dealerships

Bringing home a Bobcat, Ogemaw  
County, MICHIGAN 1935



## Victor Custom Viking™

Catalog No. 2177

This is the bow Vic Berger used to score his first back-to-back perfect games, the first ever shot in archery history. It has everything you need to win.

**Standard equipment** Berger Button, Radial-Feathered Sight Window, Magnetic Arrow Rest, Converta-Accessory Insert.

**Accessory equipment:** Bear Omnicoupler® Stabilizer, Bear Converta-Bowfishing Reel, Bear Hunting Stabilizer, Bear Take-Down Bow Travel Case, Bear-Jeffery Omni-Bowsight, No. 7105 Bear® Professional Dacron® String with monofilament serving. See page 5 on how to order Fascor™ limbs.

**AMO length:** 66", 68", 69".

**Weights:** 25 to 50 lbs.

**Draw Limit:** Unlimited.

**Handle section:** Futurewood.™ Weighed at 28" from front of arrow shelf.

**Catalog No. 2177** (Handle section only)

**To order specify:**

1. handle section catalog number
2. right or left hand





## Victor Patriot™

Catalog No. 2117

Dedicated to the 1972 United States Olympic Archery Team. This bow is the one for all future Olympic hopefuls for 1976 and 1980 to learn on. Start on your road to a Gold Medal today. Unique Big Sky Blue Futurewood with distinctive Crusader Red stripe and tips.

**Standard equipment:** Nylon Shelf Rest, Adjustable Nylon Arrow Plate, Converta-Accessory Insert, seven-inch Tournament Sight, Futurewood™ tip overlays for added strength and beauty. No. 7035 Universal Temper Strand White Dacron® Bowstring. Fascor™ powered limbs.

**Accessory equipment:** Berger Button, seven-inch Premier Tournament Sight, Bear-Jeffery Omni-Bowsight, Omni-Coupler® Stabilizer, Magnetic Arrow Rest, Hunting Stabilizer, Converta-Bowfishing Reel, Bowcase.

**AMO length:** 66".

**Weights:** 25, 30, and 35 lbs.

**Draw limit:** Unlimited.

**Handle:** Futurewood.™

**Glass color:** White. Weighed at 28" from front of arrow shelf.

Catalog No. 2117

**To order specify:**

1. catalog number
  2. bow weight
  3. right or left hand
- All Bear® glass and wood laminated bows are covered by United States patent #2,842,113. Other patents pending.

Victor Custom Viking™  
Catalog No. 2177  
Available at Qualified Bear  
Archery Service Dealerships

Victor Patriot™  
Catalog No. 2117  
Available at Qualified Bear  
Archery Service Dealerships

Mule Deer Hunt  
NORTH DAKOTA, 1955



# Victor Super Grizzly®

Catalog No. 2160

Named for one of Fred Bear's most respected and awesome trophies, Super Grizzly is known by its distinctive Team Bear Crusader Red regimental stripe and bow tip.

**Standard equipment:** Bear "Pre-furred" Silent Arrow Plate and Bearhair Arrow Rest, Converta-

Accessory Insert, distinctive Team Bear Crusader Red reinforcing and protective Futurewood™ overlays on tips, hand contoured grip with thumb rest, No. 7050 Universal Temper Strand Black Dacron Bowstring, Fascor™ Powered Limbs.

**Accessory equipment:** Bear Hunting Stabilizer, Bear Converta-Quiver, Bear Converta-Bowfishing Reel.

**AMO length:** 58" (Hunting length strung 55")

**Draw Weights:**  
Right Hand 40-45-50-55 lbs.  
Left Hand 45-50 lbs.

**Draw limits:** Unlimited

**Glass Color:** Black, Green, White

**Handle Wood:** Futurewood™, Random Colors as shown below. Weighed at 28" from front of arrow shelf.

Catalog No. 2160

**To order specify:**

1. Catalog Number
2. Bow Weight
3. Right or left handed

**Note:** Can be camouflage painted at no additional charge.

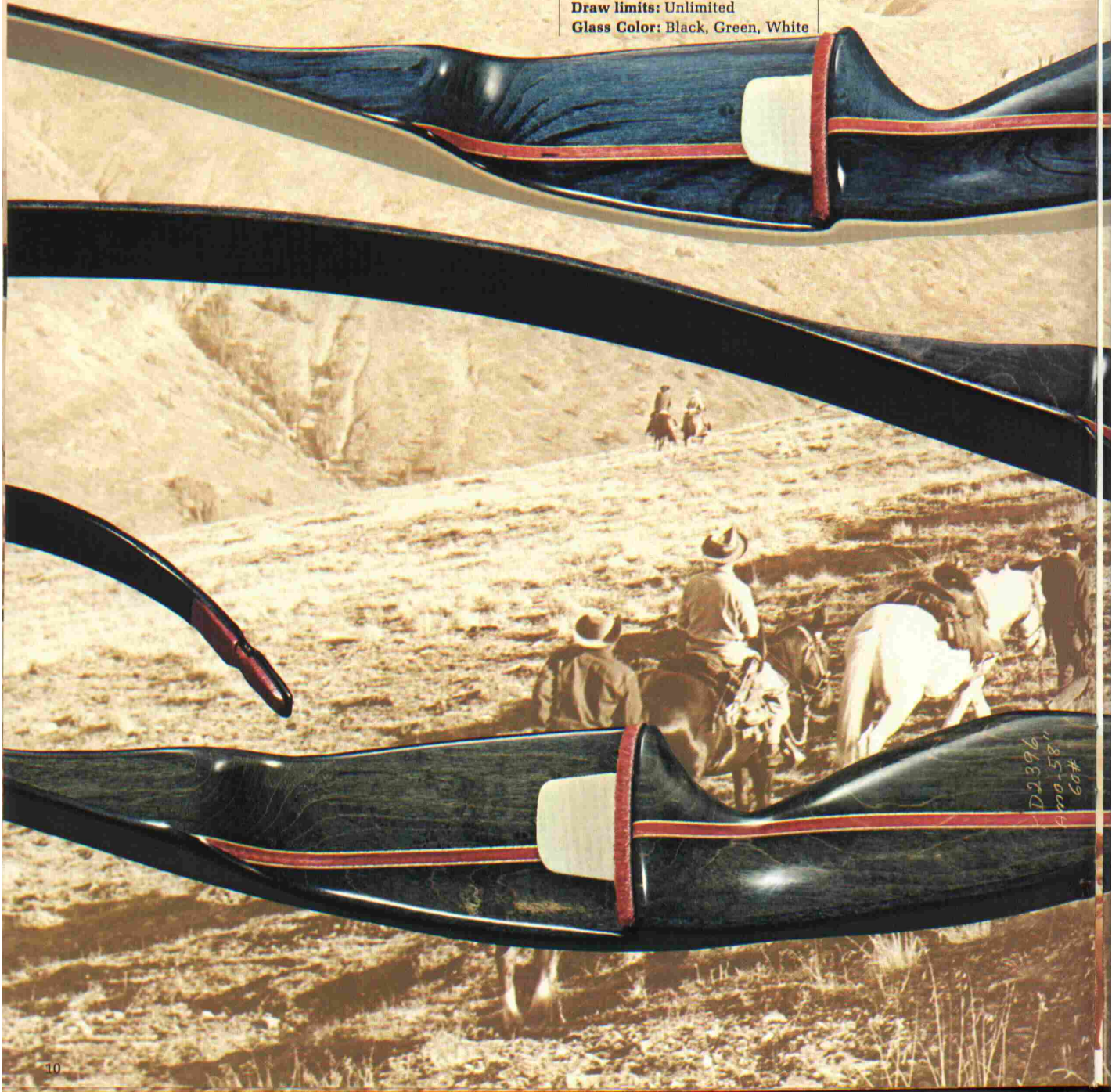

D2396  
AMO 58"  
60#





AD2393  
190-58"  
45#

**Super Grizzly, Catalog No. 2160**  
**Big Sky Blue Futurewood™**  
Available at Qualified Bear  
Archery Service Dealerships

AD2355  
190-58"  
45#

**Super Grizzly, Catalog No. 2160**  
**Midnight Black Futurewood™**  
Available at Qualified Bear  
Archery Service Dealerships

**Super Grizzly, Catalog No. 2160**  
**Forest Green Futurewood™**  
Available at Qualified Bear  
Archery Service Dealerships

On the trail at Coldfish Lake,  
BRITISH COLUMBIA 1967



## Victor Super Kodiak®

Catalog No. 2141

Fred Bear considers the wily North American Whitetail deer to be the most difficult game to bag in the world. This is the perfect bow to do just that. Midnight Black Futurewood with the distinctive Crusader red stripe and tips.

**Standard equipment:** Bear "Pre-furred" Silent Arrow Plate and Bearhair™ Arrow Rest, Converta-Accessory Insert, Fascor™ Powered Limbs, Futurewood™ overlays on tips and three-ply fibre overlays on back of handle. Hand-contoured grip with thumb rest, No. 7050 Universal Temper Strand Black Dacron® Bowstring.

**Accessory equipment:** Bear 5" Premier Hunting Sight (see note below), Bear® Hunting Stabilizer, Bear Converta-Quiver, and Bear Converta-Bowfishing Reel.

**AMO length:** 60" (Hunting length strung 57").

**Weights:** Stocked in 40, 45, 50, 55 lbs. For 35, 60, 65, 70 lbs. allow three weeks for delivery.

**Draw limit:** Unlimited.

**Glass color:** Black.

**Handle:** Futurewood.™ Weighed at 28" from front of arrow shelf.

**Catalog No. 2141**

**To order specify:**

1. catalog number
2. bow weight
3. right or left hand

**Note:** 5" Premier Hunting Sight available factory-installed on Super Kodiak® bows to 50 lbs. weight only.

**(Note:** Can be ordered Bear camouflage-painted at no additional charge.)

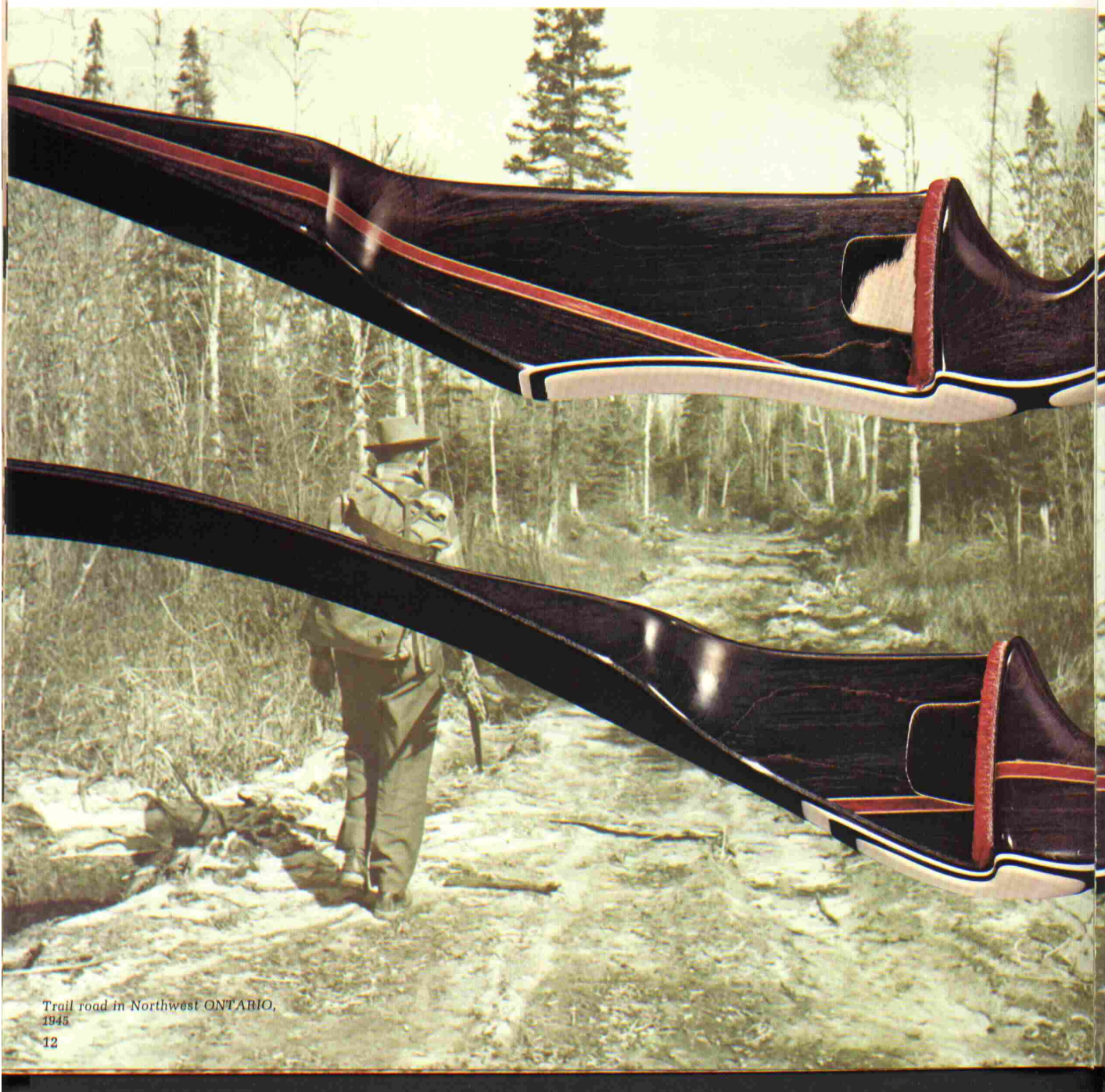

Trail road in Northwest ONTARIO,  
1945



## Victor Super Magnum® "48"

Catalog No. 2146

This is the bow for you if you hunt from tree blinds or in heavy cover. The ultimate in a short hunting bow. Designed by the ultimate in hunters, Fred Bear. Midnight Black Futurewood with the distinctive Crusader Red stripe and tips.

**Standard equipment:** Bear® "Prefurred" Silent Arrow Plate and Bearhair Arrow Rest, Converta-Accessory Insert, Fascor™ Limb Core, Futurewood™ overlays on tips and three-ply Bearglas® overlays on back of handle for added strength and beauty, hand-contoured grip with thumb rest, No. 7050 Universal Temper Strand Black Dacron® Bowstring.

**Accessory equipment:** Bear Hunting Stabilizer, Bear Converta-Quiver, Bear Converta-Bowfishing Reel.

**AMO length:** 48" (Hunting length strung 45").

**Weights:** Stocked in 40, 45, 50, 55 lbs. For 35, 60, 65, 70 lbs. allow three weeks for delivery.

**Draw limit:** Unlimited.

**Glass color:** Black.

**Handle:** Futurewood™ Weighed at 28" from front of arrow shelf.

**Catalog No. 2146**

**To order specify:**

1. catalog number
2. bow weight
3. right or left hand

(Note: Can be ordered Bear camouflage-painted at no additional charge.)



Victor Super Kodiak®  
Catalog No. 2141  
Available at Qualified Bear  
Archery Service Dealerships

Victor Super Magnum® "48"  
Catalog No. 2146  
Available at Qualified Bear  
Archery Service Dealerships

Minutes after this picture was taken  
Fred downed a 250 lb. black bear  
from this tree blind in Northwest  
ONTARIO, 1945.



## Kodiak Hunter®

Catalog No. 2156

A hefty handful of power for the hunter who likes to feel the strength of the bow in his grasp. You can take this bow anywhere, hunt anything. Forest Green Futurewood™ green accent tips.

**Standard equipment:** Silent Arrow Plate, Bear-hair Arrow Rest, Converta-Accessory Insert, Futurewood™ overlays on tips and three-ply Beaglas™ overlays on

back of handle for added strength and beauty, found only on Bear® bows, hand-contoured grip with thumb rest, No. 7050 Universal Temper Strand Black Dacron® Bowstring.

**Accessory equipment:** Bear Hunting Stabilizer, Bear Converta-Quiver, Bear Converta-Bowfishing Reel.

**AMO length:** 60" (Hunting length strung 57").

**Weights:** Stocked in 40, 45, 50, 55 lbs. For 35, 60, 65, 70 lbs. allow three weeks for delivery.

**Draw limit:** Unlimited.

**Glass color:** Forest Green.

**Handle woods:** Futurewood™  
Weighed at 28" from front of arrow shelf.

Catalog No. 2156

**To order specify:**

1. catalog number
2. bow weight
3. right or left hand

**[Note:** Can be ordered camouflage-painted at no additional charge.)





## Kodiak Magnum®

### Catalog No. 2151

For the man who wants a second bow, for hunting in heavy cover, with the same good looks and heft of the Kodiak Hunter. The two Kodiaks also make a terrific Father/Son combo. Start him off right, start him with a Kodiak Magnum. Forest Green Futurewood, green accent tips.

**Standard equipment:** Silent Arrow Plate, Bearhair™ Arrow Rest, Converta-Accessory Insert, Futurewood™ overlays on tips and three-ply Bearglas® overlays on back of handle for added strength, hand-contoured grip with thumb rest, No. 7050 Universal Temper Strand Black Dacron® Bowstring.

**Accessory equipment:** Bear® Hunting Stabilizer, Bear Converta-Quiver, Bear Converta-Bowfishing Reel.

**AMO length:** 52" (Hunting length strung 49").

**Weights:** Stocked in 40, 45, 50, 55 lbs. For 35, 60, 65, 70 lbs. allow two weeks for delivery.

**Draw limit:** Unlimited.

**Glass color:** Forest Green.

**Handle woods:** Futurewood.™ Weighed at 28" from front of arrow shelf.

### Catalog No. 2151

#### To order specify:

1. catalog number
2. bow weight
3. right or left hand

**(Note:** Can be ordered Bear camouflage-painted at no additional charge.)

Kodiak Hunter® Catalog No. 2156  
Forest Green Futurewood

Kodiak Magnum® Catalog No. 2151  
Forest Green Futurewood

Heading back to camp, Jack Albright and Fred Bear, Little Delta, ALASKA, 1958.



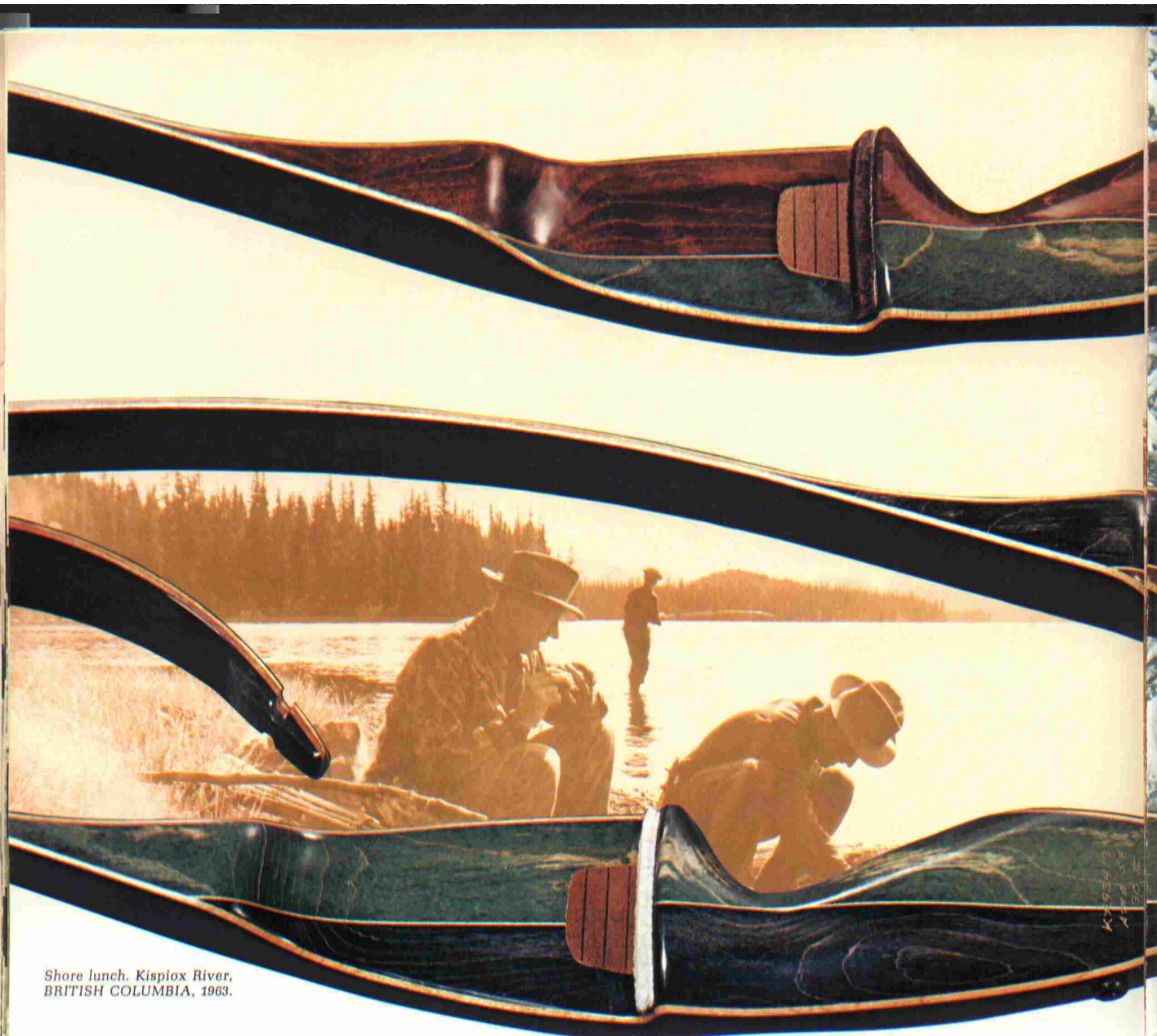

Shore lunch. Kispiox River,  
BRITISH COLUMBIA, 1963.

## Bear Grizzly®

### Catalog No. 2161

We call Grizzly our Two-Season Hunter bow. It's for the gun hunter who wants to try the challenge of the bow, who wants to stalk to within 40 yards for his shot, who wants to double his hunting season by hunting with both his gun and his bow during the separate season for each. Shipped in random color combinations as shown—Midnight Black, Forest Green, Bark Brown.

**Standard equipment:** Leather Arrow Plate, Bearhair Arrow Rest, Converta-Accessory Insert, reinforcing and protective Futurewood™ overlays on tips, hand-contoured grip with thumb rest, No. 7050 Universal Temper Strand Black Dacron® Bowstring.

**Accessory equipment:** Bear® Hunting Stabilizer, Bear Converta-Quiver, Bear Converta-Bowfishing Reel.

**AMO length:** 58" (Hunting length strung 55").

**Weights:** Stocked in 40, 45, 50 lbs. For 35, 55, 60, 65, 70 lbs. allow two weeks for delivery.

**Draw limit:** Unlimited.

**Glass color:** Bark Brown.

**Handle wood:** Futurewood.™ Weighed at 28" from front of arrow shelf.

### Catalog No. 2161

#### To order specify:

1. catalog number
2. bow weight
3. right or left hand

(Note: Can be ordered camouflage-painted at no additional charge.)



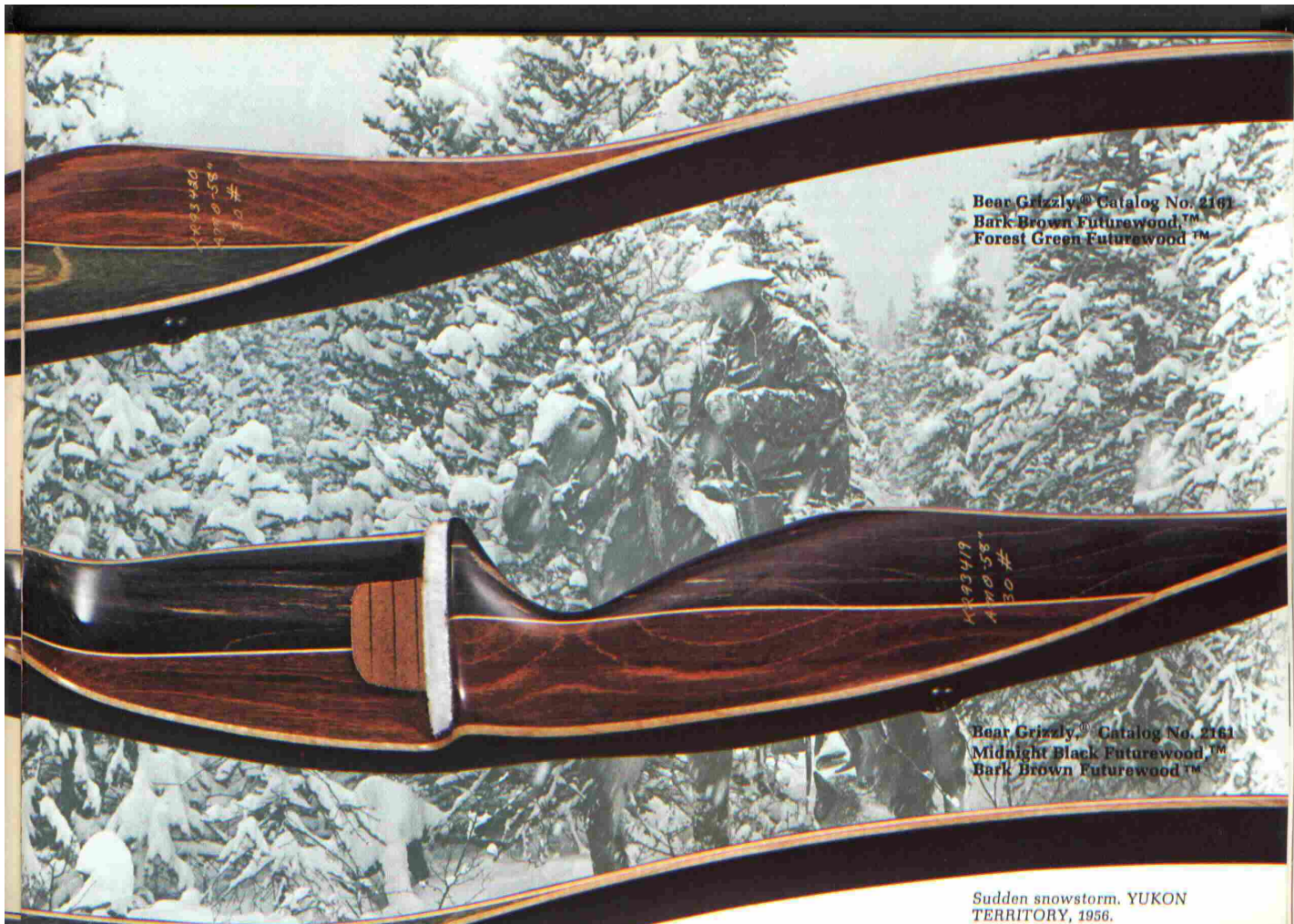

Bear Grizzly,® Catalog No. 2161  
Bark Brown Futurewood,™  
Forest Green Futurewood™

Bear Grizzly,® Catalog No. 2161  
Midnight Black Futurewood,™  
Bark Brown Futurewood™

Sudden snowstorm. YUKON  
TERRITORY, 1956.

Bear Grizzly,® Catalog No. 2161  
Forest Green Futurewood,™  
Midnight Black Futurewood™



**2162 Grizzly® Two-Season  
Hunt Set**  
Grizzly bow (45 lbs.) four 29"  
cedar arrows with Razorheads.  
6 auxiliary blades, armguard,  
Huntsman 6-arrow belt quiver,  
shooting glove, animal target  
face, and instruction book.  
Individually packaged. Specify  
right or left hand.



## Black Bear®

Catalog No. 2126

Named for one of the most sought after trophies in North America. This proven beginner's bow serves double duty at both the target line and the hunter's blind.

**Standard equipment:** Converta-Accessory Insert, Leather Arrow Plate and Bearhair™ Arrow Rest, No. 7050 Universal Temper Strand Black Dacron® Bowstring.

**Accessory equipment:** Omni-Coupler Stabilizer, Hunting Stabilizer, Bear Converta-Quiver, Bear Converta-Bowfishing Reel.

**AMO length:** 60" (Hunting length strung 58").

**Weights:** 25, 30, 35, 40, 45, 50 lbs.

**Draw limit:** Unlimited.

**Glass color:** Assorted light glass on weights 25, 30 and 35 lbs. Dark on weights 40, 45 and 50 lbs.

**Handle wood:** Selected hardwoods. Weighed at 28" from front of arrow shelf.

**Catalog No. 2126**

**To order specify:**

1. catalog number
2. bow weight
3. right or left hand



**2127 Black Bear® Target Set**

Black Bear bow (25 lbs.), 4 28" matched cedar arrows, convertible right or left hand shooting glove, armguard, belt quiver, 16" colorful target face, instruction book. Individually packaged. Specify right or left hand.



**2128 Black Bear® Bowhunter Set**

Black Bear bow (45 lbs.), 4 29" matched cedar arrows with Razorheads, 6 auxiliary blades, armguard, convertible right and left hand shooting glove, bow quiver, 12" animal target face, Fred Bear's bow-hunting tips booklet. Individually packaged. Specify right or left hand.

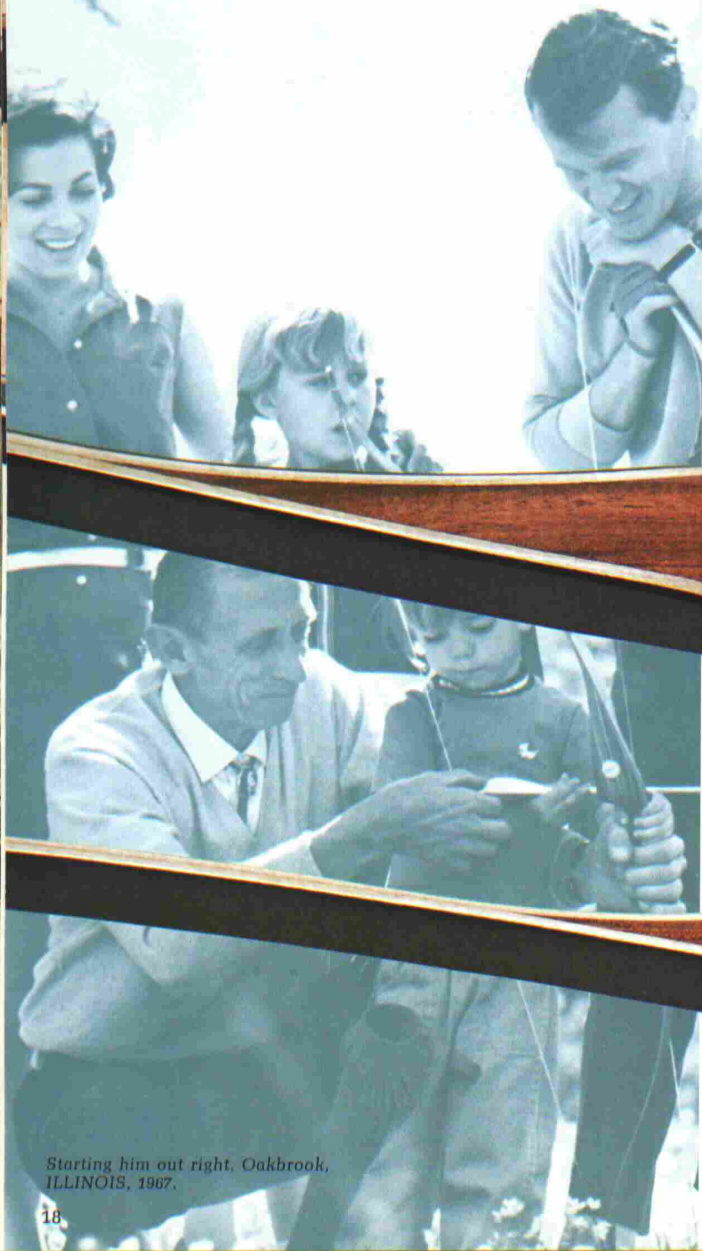

Starting him out right, Oakbrook, ILLINOIS, 1967.



## Little Bear®

Catalog No. 2136

This is the bow the Pro's start their youngsters off with, a full working recurve with a full sight window and great accuracy. The finest bow we make for your young son or daughter. Crafted of selected hardwoods.

**AMO length:** 48".

**Weight:** 20 lbs. at 24" draw.

**Glass color:** Random.

**Handle wood:** Hand-picked selected hardwoods. Weighed at 24" from front of arrow shelf.

Catalog No. 2136

To order specify:

1. catalog number
2. right or left hand



### 2137 Little Bear® Set

Little Bear bow (20 lbs.), four cedar arrows, Bearhide quiver, armguard, convertible right and left hand shooting tab, 16" colorful target face, instruction booklet. Specify right or left hand.

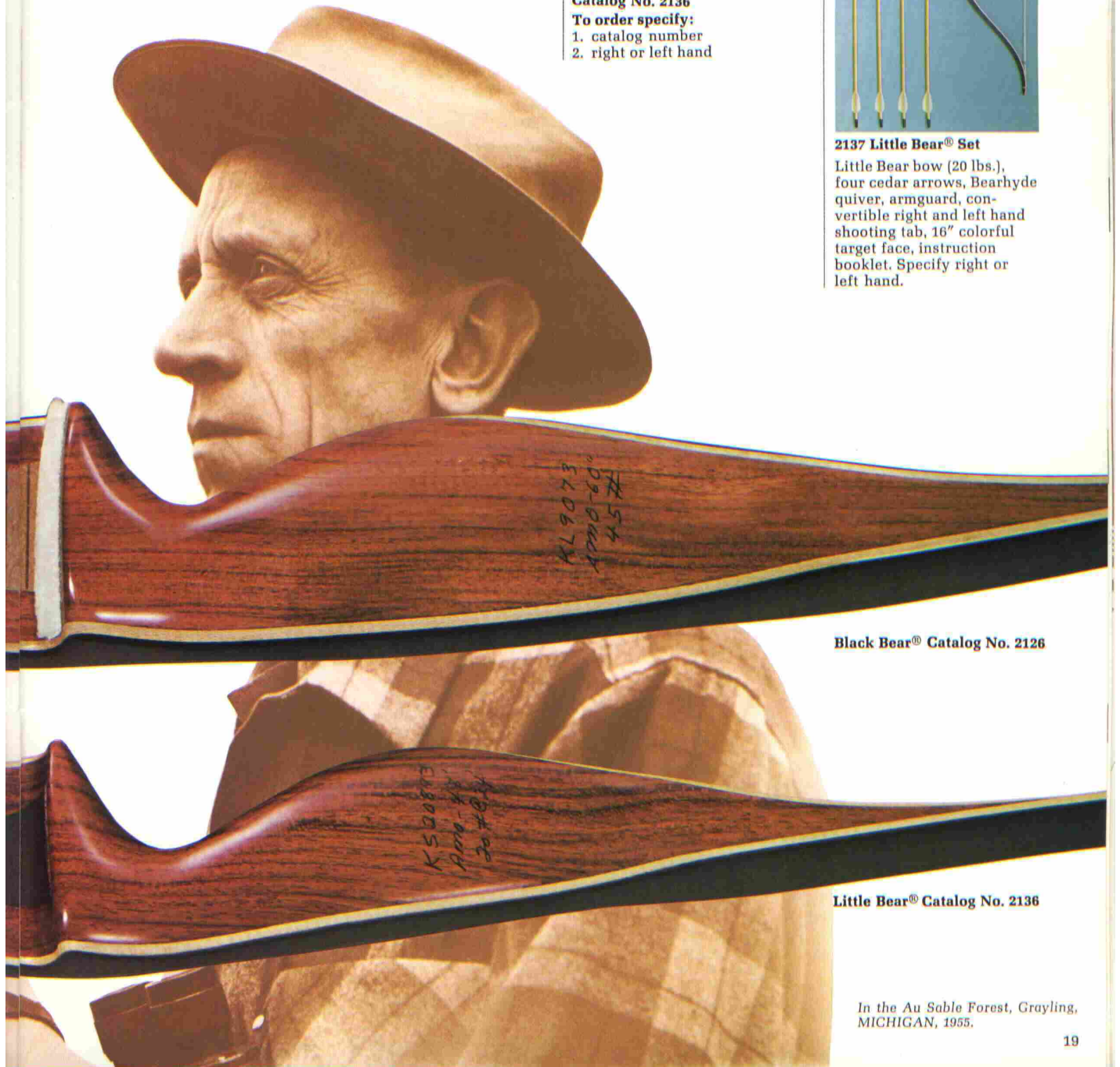

Black Bear® Catalog No. 2126

Little Bear® Catalog No. 2136

In the Au Sable Forest, Grayling, MICHIGAN, 1955.





The bow all America has been waiting for, the bow that will win over both the Archie Bunkers and the Michael Spivaks. The bow that will enable all Americans to get into the challenging sport of archery. Bear '76er. Fred Bear's way of thanking America for helping to fulfill his "impossible dream." Handles, limbs and grips in random reds, whites and blues. Take down design for compact storage and easy travel. "Bear '76er" Take Down Handles are covered by U.S. Patents #2,842,113, #D-204,065, #3,415,241.

## Bear '76er™ Deluxe

Catalog No. 2164

**Standard equipment:** Bearhair Arrow Rest, Silent Arrow Plate, Converta-Accessory Insert, Adjustable Pin Bear '76er Bowsight, Standard Pistol Handle Grip-assorted red, white, blue. High impact molded reinforcing and protective overlays on tips, No. 7050 Universal Black Temper Strand Bowstring.

**Accessory equipment:** Bear Omni-Coupler® Stabilizer, Bear Hunting Stabilizer, Bear Converta-Bow Quiver, Bear Converta-Bowfishing Reel. Assorted Red, White and Blue Standard Pistol Grips.

**AMO length:** 64"

### Draw weights:

Light Weight (25/30 lbs.);  
Medium Weight (30/35 lbs.);  
Heavy Weight (40/45 lbs.);  
Extra Heavy Weight. (45/50 lbs.)

**Draw limit:** Unlimited.

**Glass color:** Random red, white and blue fiberglass limbs.

**Handle material:** Space Age Magnesium.

**Handle color:** Random red, white, and blue handle sections. Weighed at 28" from front of arrow shelf.

Catalog No. 2164



**Bowcase:** Catalog No. 3504.

Handy tote-case of durable vinyl. Holds one handle and two limbs. Fits both '76er Deluxe and Custom models and Minuteman Long and Short models.

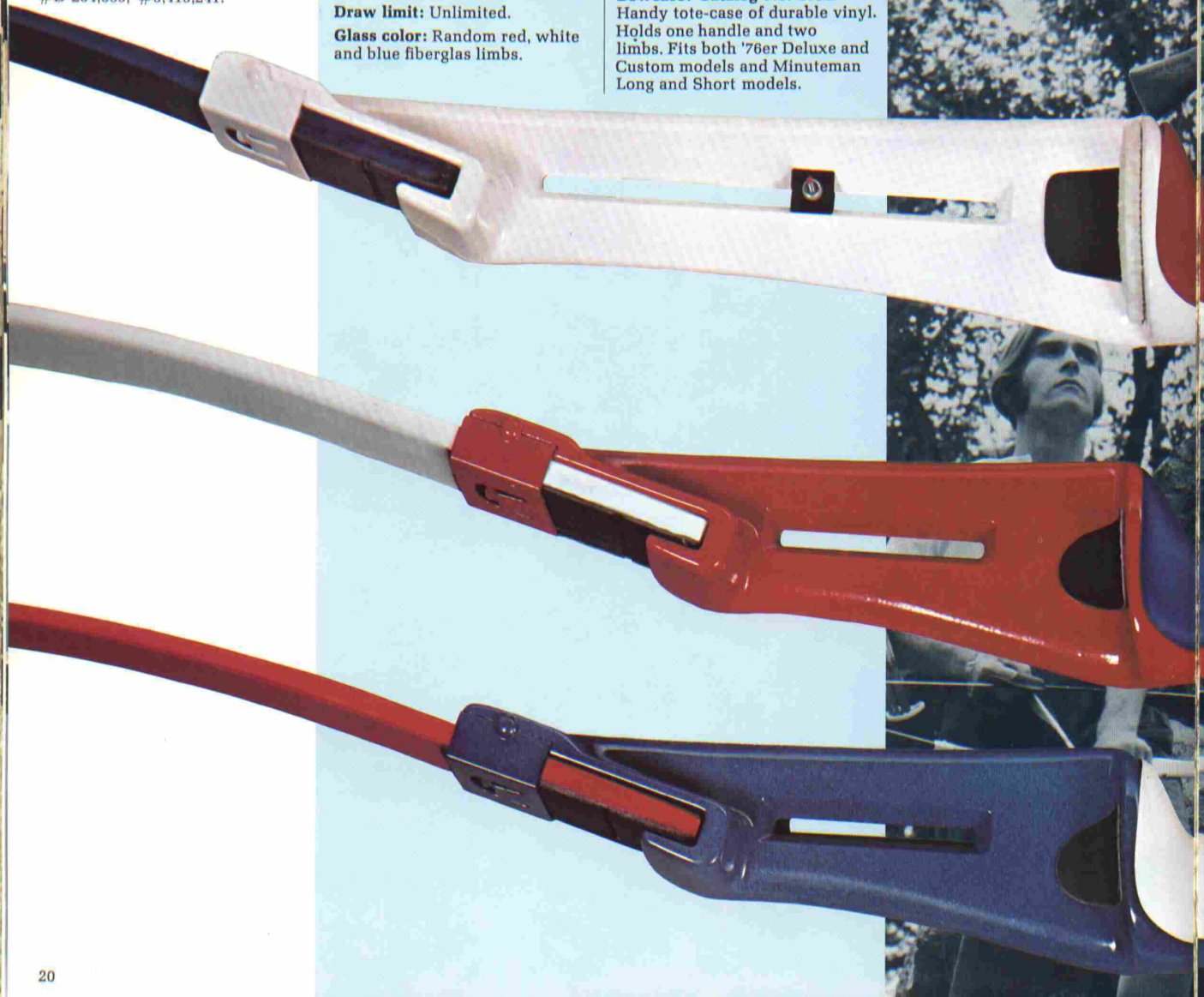



## Bear '76er™ Custom

Catalog No. 2158

**Standard equipment:** Leather Arrow Rest/Plate, High impact molded decorative and reinforcing overlays on tips, No. 7050 Universal Black Temper Strand Bowstring, Converta-Accessory Insert.

**Accessory equipment:** Bear Hunting Stabilizer, Bear Converta-Bow Quiver, Bear Omni-Coupler® Stabilizer, Bear '76er Bowsight, Converta-Bowfishing Reel, Assorted Red, White and Blue Standard Pistol Handle Grips.

**AMO length:** 58".

**Draw weights:**

Light Weight (25/30 lbs.);  
Medium Weight (30/35 lbs.);  
Heavy Weight (40/45 lbs.);  
Extra Heavy Weight. (45/50 lbs.)

**Draw limit:** Unlimited.

**Glass color:** Random red, white and blue limbs.

**Handle material:** Space Age Magnesium.

**Handle color:** Random red, white and blue handle sections. Weighed at 28" from front of arrow shelf.

Catalog No. 2158



**Grips:** Catalog No. 2181. Choice of three different colors. Non-slip vinyl, simple to install. Available only in No. 1 grip model. Standard equipment on '76er Deluxe, optional on '76er Custom. Specify red, white or blue.



**Bowsight:** Catalog No. 6090.

Standard equipment on '76er Deluxe, optional on '76er Custom. Two apertures per package.

**Bear '76er Deluxe™,**  
Catalog No. 2164  
White Handle, Blue Limbs,  
Red Grip.

**Bear '76er Custom™,**  
Catalog No. 2158  
Red Handle, White Limbs.  
Shown with Blue Grip available  
at extra cost.

**Bear '76er Custom™,**  
Catalog No. 2158  
Blue Handle, Red Limbs.  
Shown with White Grip available  
at extra cost.

*Photographed at the statue of Captain John Parker, leader of the Minutemen on the morning of April 19, 1775 at the first battle of the American Revolutionary War at Lexington Green, Lexington, Massachusetts. "If they mean to have a war, let it begin here."*





## New Bear Minuteman

Catalog No. 2115 66"  
Catalog No. 2110 60"

For tournament and hunting. Featuring the same composite limb manufacturing techniques as used on our highest price bows. Minuteman Long Handle and No. 1 Grip in random red, white and blue. Minuteman Short Handle in Little Delta Green with No. 1 Black Grip. Take down design for compact storage and easy travel. Available Right and Left Handed.

**Standard Equipment:** Bearhair Arrow Rest, Silent Arrow Plate, Converta-Accessory Insert, No. 1 Handle Grip—random red, white and blue, High Impact molded reinforcing and protective overlays on tips. Universal Temper Strand Bowstring.

**Accessory equipment:** Bear Omni-Coupler® Stabilizer, Bear Hunting Stabilizer, Bear Converta-Bow Quiver, Bear Converta-Bowfishing Reel, Assorted No. 1 Red, White, Blue and No. 2—No. 3 Black Grips. Bear 6090 Bowsight. 3504 Bowcase.

### AMO length:

Minuteman Long Handle (66")  
Minuteman Short Handle (60")  
Both models feature the same Standard and Accessory equipment.

**Draw weights:** Minuteman Long (66") 25, 30, 35, 40, 45 lbs.  
Minuteman Short (60") 28, 33, 38, 43, 48 lbs.

**Draw Limit:** Unlimited.

**Glass Color:** 25 lbs. through 38 lbs.—white glass, Laminated Composite Limbs. 40 lbs. through 48 lbs.—Random dark glass, Laminated Composite Limbs.

**Handle Material:** Space Age Magnesium.

Photographed at Concord Bridge, Concord, Massachusetts where the Minutemen fired the shot heard around the world during the first day of the American Revolution.

## Instant Archery™ Instant Archery set 5581

It's the instruction book that makes you the instant archer. In eight pages, with crisp text written by a certified instructor of the Professional Archers Association (PAA), and clear photographs, you learn how to hold your bow, your arrow; how to aim, anchor, and shoot. Many archers score consecutive bull's-eyes in their first shots.

But that's only for openers. With your Instant Archery set you get a solid Fiberglas bow, fully 60" long, with adjustable bowsight, Fred Bear® "Arro-Guide" rest, rear sight on the double-looped braided Dacron® bowstring, and comfortable Bear-Gluv finger grips to eliminate the need for shooting glove, and to give you the correct nocking point (arrow to bowstring). More? If you have left-handers and right-handers in your family, simply move the "Arro-Guide" to left or to right, to accommodate.

Arrows? Yes, four 28" cedar arrows with the distinctive Instant Archery crest. And a long armguard to protect your arm from string slap. Plus a safe, easy-to-use bowstringer.

There's even a target: a four-sided box-like arrangement which you stuff with folded newspaper for stability and long life.

Instant Archery. Instant fun. For the family. (Not a toy.) See your Bear® dealer.



### 1775 Instant Archery replacement arrows

High-grade 28" cedar arrows. Spine-matched to match your Instant Archery bow. Half-dozen, boxed.

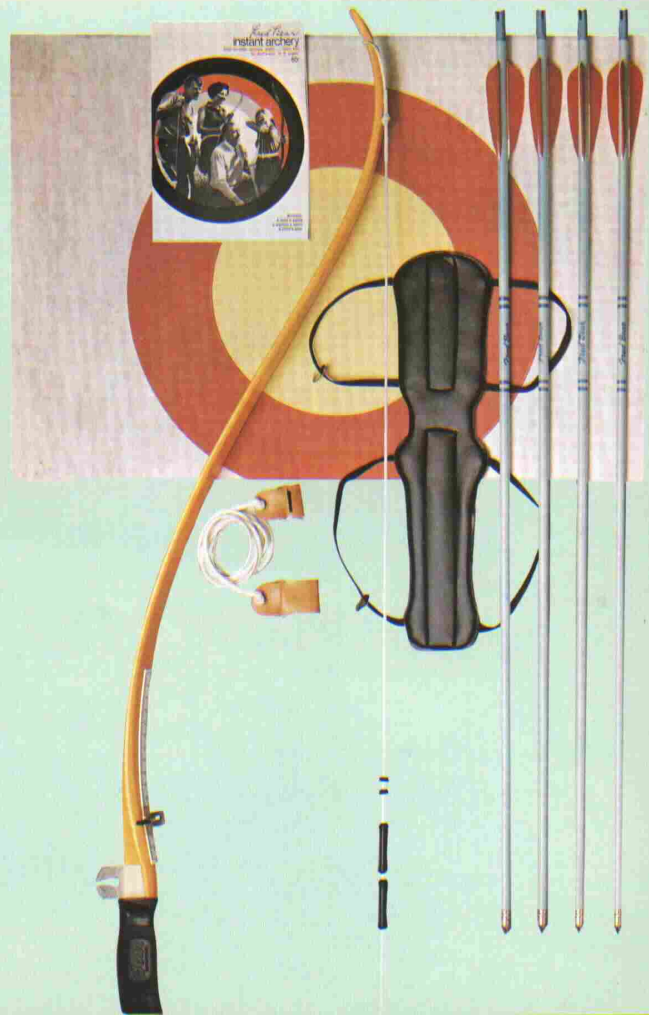



**Handle Color:** Minuteman Long (66") Random red, white and blue. Minuteman Short (60") Little Delta Green. Weighed at 28" from front of arrow shelf.

**Grips: Catalog No. 2181:** Minuteman Long (66") Random red, white and blue No. 1 grip. Minuteman Short (60") Black No. 1 grip. Specify color when ordering additional grips.

**Bowsight: Catalog No. 6090.** Optional equipment accessory, fits both the Minuteman Long and Minuteman Short. Two apertures per package.

**Catalog No. 2115** Minuteman Long 66".

**Catalog No. 2110** Minuteman Short 60".

**Bear Minuteman Limbs:**  
**Catalog No. 2113.**

For Long and Short handles. Various weight limbs may be ordered separately enabling you to have one weight for tournament archery and another for hunting. Available in 25, 28, 30, 33, 35, 38, 40, 43, 45, 48 lbs. weights. Specify weight.

**Bear Minuteman Long:**  
**Catalog No. 2115.**

**Solid Fiberglass®  
Bows and Sets**

There's a Bear bow here for everyone. Any age. Boys, girls, men, women. A Fiberglass Bear bow starts many an archer on his way to more fun, to more sport, and even to more sophisticated bows. Start here. For yourself. For the family. For a gift. For target shooting, bowhunting, bowfishing, backyard fun. Each bow shoots left or right. Complete with braided Dacron® double-loop bowstring.

**5501 Blue Bear® set**  
Start the boy—or girl—with this one. Designed for the beginner, with 40" Blue Bear bow, double-loop braided Dacron® bowstring, three 28" cedar arrows, instruction booklet, target face. Not a toy.

Dealer note: three sets per carton.

**5506 Red Bear® set**  
For older boys and girls. Red Bear 50" bow, double-loop braided Dacron® bowstring, three 28" cedar arrows with pro target points, vinyl quiver, target face, instructions. Not a toy.

Dealer note: three sets per carton.

**5511 Green Bear® target set**  
Backyard family fun included. Also: 56" 25-lb. Green Bear bow, double-loop center-served braided Dacron® bowstring, three 28" cedar arrows, new belt quiver, right or left shooting tab, armguard, championship target, instructions.

Dealer note: three sets per carton.

**5515 Green Bear® bowhunting set**  
Fred Bear, internationally famed big game bowhunter, wrote a booklet, "Fred Bear's Tips on Bowhunting." You'll find it in the set. You'll also find a 56" 45-lb. Green Bear bow, three 29" cedar arrows with single-blade Razorheads®, double-loop center-served braided Dacron® bowstring, bow quiver, armguard, right or left shooting tab, full-color target face. You're loaded, with Bear!

Dealer note: three sets per carton.

**5521 Golden Bear® set**  
Target set. Features 60" recurve Golden Bear bow rated at 30 lbs, with double-loop center-served braided Dacron® bowstring, four 28" matched cedar target arrows. Belt quiver. Armguard. Right or left shooting tab. Full-color target. Instruction booklet.

Dealer note: three sets per carton.

**5526 Brown Bear® bowhunting set**  
The bowhunter or bowfisherman will appreciate this one. 60" 45-lb. recurved Brown Bear hunter bow with center-served braided Dacron® bowstring, three top-of-line Fred Bear 29" cedar hunting arrows with Razorheads®, bow quiver, right and left shooting tab, armguard, full-color animal target face, and "Fred Bear's Tips on Bowhunting" booklet.

Dealer note: three sets per carton.

**5500 Blue Bear bow only**  
Dealer note: six bows per carton.

**5505 Red Bear bow only**  
Dealer note: six bows per carton.

**5510 Green Bear bow only**  
(25, 35, 45 lbs.) Dealer note: four bows per carton.

**5520 Golden Bear bow only**  
(30 lbs.) Dealer note: four bows per carton.

**5525 Brown Bear bow only**  
(45 lbs.) Dealer note: four bows per carton.





## Converta-Point® Arrows

**WACA—Wooden Arrow Converta-Point Adapter**—gives you the ultimate in convenience and economy arrows. Fred Bear "Plus 3" Converta-Point arrows are now available in aluminum, glass, or wood shafts.

**"Plus 3" Converta-Point Aluminum and Glass shafts** are fitted with a unique insert that accepts the threads of the screw-in "Plus 3" Converta-Point arrow. The insert gives your arrow a compressive, shock-resistant fit.

**The "Plus 3" Converta-Point offers:** 1—a special adapter to fit Razorhead® arrows; 2—a blunt point matched to Razorhead weight; 3—a field point matched to Razorhead weight.

Now, a dozen "Plus 3" Converta-Point is all you need for big game hunting, small game hunting field shooting, or hunting practice. No tools required; simply screw in the head you need. To prepare your present 1 1/32" cedar shafts, simply saw off the point and install the WACA with Bear® Quick Stick™ cement. You retain the shaft's original length, and you've increased your dozen arrows into three dozen multi-purpose arrows. And the 40 grains of weight gives you more penetrating power for hunting.



5234 Razorhead®, 1340 WACA, 1332 Field Point, 1333 Blunt.

### 1325 NEW Tuff-Tip

Stop worrying about hitting those stumps. Fits over the end of your arrow between the fiberglass shaft and the Converta-Point. Virtually eliminates arrow splintering. Acts as a shock absorber. Packed in all Bear Microflite arrows. Dozen pack.

## Aluminum

**Fred Bear® "Plus 3" Converta-Point® Magnum Arrows for hunting and field** are made by James D. Easton to Fred Bear's specs. Has to be the toughest arrow you've seen. Made of aluminum alloy, and coated with a hard anodic film for long-wearing, non-corrosive, glareless life.

There's more: a cap-dip finish. Pinstriping. Matched feathers fletched to a proper helical.

Fred Bear® Magnum™ arrows are stocked in full length, 29" and 31" only, and in these tube sizes for all hunting and field arrows: .308 for 40/50 lb bows, .312 for 50/60 lb bows, .316 for 60/70 lb bows, and .320 for 70/80 lb bows. (Magnum arrows in .324 and .328 are available on special order. The 29" .324 arrow weighs 625 grains; the .328 weighs 655 grains. These heavier shafts are recommended for 65 lb bows and up.) Specify bow weight and draw length.

**Dozen**—All arrows stocked in 29" and 31" lengths.

**1030** Magnum arrows fitted with high-strength inserts (no points).

**1031** Full length Magnum arrows with high-strength inserts unattached (no points).

**1032** Magnum arrows with Converta-Field points (125 grain).

**1033** Magnum arrows with Converta-Blunt points (125 grain).

**1034** Magnum arrows with Converta-Point four-blade Razorhead (125 grain).

**1035** Matched set of Magnum arrows with six 125-grain four-blade Razorhead and six 125-grain Converta-Field points.

**Note:** For Magnum arrows in lengths other than 29" or 31" please allow two to four weeks for delivery.

For extra points, inserts, and Razorhead, see "Plus 3 Converta-Point Components," page 25.

## Fiberglas®

**NEW Bear Micro-Flite® Grayling Green "Plus 3" Converta-Point® Arrow for Hunting and Field**

Now manufactured in Grayling to Fred Bear's strictest specifications. The arrow with excellent concentricity and straightness. Impervious to the elements. Unaffected by moisture or temperature. With distinctive new Grayling Green Color. Multi-colored hand-crafted cresting.

Available in 4 different sizes—#7, #8, #9, #10. Premium feathers in proper 5/4" hunting length fletched to a true helical. Specify exact bow weight and draw length.

**Dozen**—Stocked in full length, 29" and 31" lengths.

**1070** Bear Micro-Flite arrows fitted with high-strength inserts (no points).

**1071** Full length Bear Micro-Flite arrows with high-strength inserts unattached (no points).

**1072** Bear Micro-Flite arrows with Converta-Field points (125 grain).

**1073** Bear Micro-Flite arrows with Converta-Blunt points (125 grain).

**1074** Bear Micro-Flite arrows with Converta-Point four blade Razorhead (125 grain).

**1075** Matched set of Bear Micro-Flite arrows with six 125 grain Converta-Field points and six 125 grain four-blade Razorheads.

**1325 NEW Tuff-Tip**

**Note:** For Bear Micro-Flite arrows in lengths other than 29" or 31", please allow two to four weeks for delivery.

For extra points, inserts, and Razorhead, see "Plus 3 Converta-Point Components," page 25.

## Fiberglas®

**NEW Fred Bear Kodiak® "Plus 3" Converta-Point® Fiberglas Arrows for Hunting and Field**

Manufactured of the same fine material used in our New Bear Micro-Flite Grayling Green Arrows. Good concentricity and straightness. Available in 4 different sizes—#7, #8, #9, #10. Uncrested. Premium feathers in proper 5/4" hunting length fletched to a true helical. Specify exact bow weight and draw length.

**Dozen**—Available only in 29" and 31" lengths.

**1090** Kodiak arrows fitted with high-strength inserts (no points).

**1091** Full-length Kodiak arrows with high-strength inserts unattached (no points).

**1092** Kodiak arrows with Converta-Field points (125 grain).

**1093** Kodiak arrows with Converta-Blunt points (125 grain).

**1094** Kodiak arrows with Converta-Point four-blade Razorhead (125 grain).

**1095** Matched set of Kodiak arrows with six 125-grain four-blade Razorhead and six 125-grain Converta-Field points.

For extra points, inserts, and Razorhead, see "Plus 3 Converta-Point Components."

® Registered trademark, Owens-Corning Fiberglas Corp.





## Cedar

**New WACA Bear® Top Grade "Plus 3"™ Converta-Point® Cedar Arrows for hunting and field—with WACA (Wooden Arrow Converta-Point Adapter).** Port Orford cedar is selected for Bear's top grade "Plus 3" Converta-Point cedar arrows. Excellent quality and flight characteristics; archers' favorite. Spine-matched to  $\pm 2\frac{1}{2}$  lbs. in weights 35 to 65 lbs.—the closest mass-produced spine-matched cedar arrows made. Premium feathers; proper  $5\frac{1}{4}$ " helical fletching. Stocked only in full length, 29" and 31". Specify bow weight and draw length.

**Dozen—**All arrows stocked in 29" and 31" lengths.

**1040** Cedar arrows with WACA adapter attached (no points).

**1041** Full-length cedar arrows with WACA adapters unattached (no points).

**1042** Cedar arrows with Converta-Field points (125 grain).

**1043** Cedar arrows with Converta-Blunt points (125 grain).

**1044** Cedar arrows with Converta-Point four-blade Razorhead (125 grain).

**1045** Matched set cedar arrows with six 125-grain four-blade Razorhead and six 125-grain Converta-Field points.

**Note:** For top-grade cedar arrows in lengths other than 29" and 31", please allow two to four weeks for delivery.

### "Plus 3" Converta-Point® components

**1322** Nock inserts for Kodiak® and Bear Micro-Flite® arrows. Dozen pack. Specify shaft size.

**1332** Converta-Field points (125 grain). Matched to Razorhead weight. Dozen pack.

**1333** Converta-Blunt points (125 grain). Matched to Razorhead weight. Dozen pack.

**5234** Converta-four-blade Razorhead with adapters attached. Dozen pack.

**5237** Converta-four-blade Razorhead with adapters attached. Three pack.

**1335** Converta-broadhead adapter for Magnum arrows. Dozen pack.

**1336** Converta-high-strength inserts for Magnum, Kodiak, and Bear Micro-Flite® "Plus 3" Converta-Point shafts. Specify shaft size. Dozen pack.

**1340** WACA-high-strength Wooden Arrow Converta-Point Adapter for  $1\frac{1}{32}$ " shafts only. Dozen pack.

**7372**  $\frac{5}{16}$ " Judo-Point for aluminum and cedar Converta-Point arrows.

**7373**  $1\frac{1}{32}$ " Judo-Point for Fiberglass Converta-Point arrows.

The Fred Bear® "Plus 3" Converta-Point arrow is covered by U.S. patent #3,401,938.



### WACA Bear top-grade cedar "Plus 3" Converta-Point® Flu-Flu™ arrows

Swift and accurate, with limited action for bird shooting, small game, trap. Smart feather design provides fast flight at release, then slows at arc to limit distance. Stocked in 29" length and weights 35 lbs. to 65 lbs. Specify bow weight.

Box of four.

**1047** Cedar Flu-Flu arrows with Converta-Blunt points (125 grain).

**1048** Cedar Flu-Flu arrows with Converta-Field points (125 grain).

**1049** Cedar Flu-Flu arrows with Converta-Point four-blade Razorhead (125 grain).

**Note:** For cedar Flu-Flu arrows in lengths other than 29", allow two to four weeks for delivery.

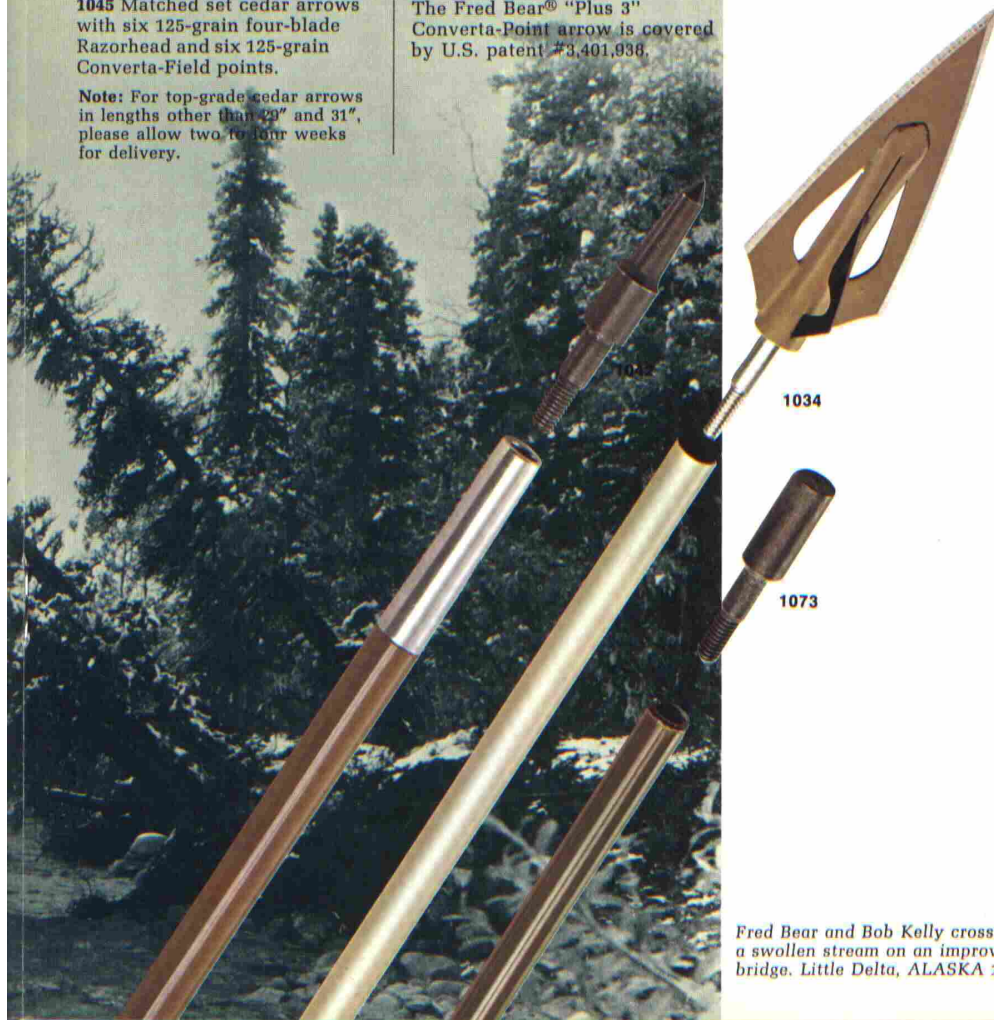

Fred Bear and Bob Kelly crossing a swollen stream on an improvised bridge. Little Delta, ALASKA 1959.



## Arrows

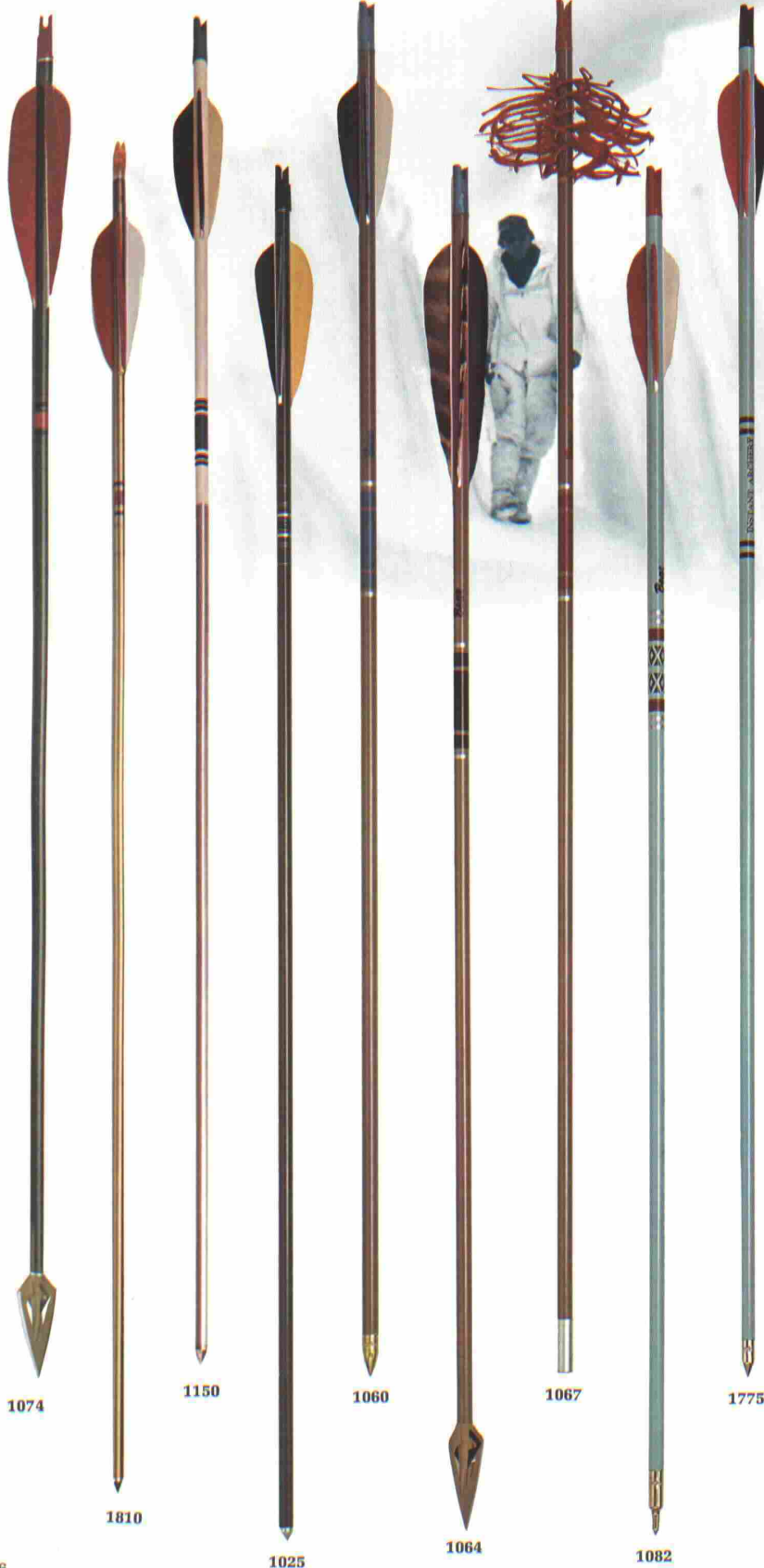

## Aluminum

**Bear®-Easton Professional X-7 tournament arrows** are preferred by top tournament archers. It's the Easton quality tubing manufactured to exacting tolerances that makes the big difference. Beautiful Meadow Green color; multi-color hand crestring, helical fletching of proper length for target shooting. Available in sizes 1516, 1616, 1716, 1814, 1816, 1914. BJORN nocks. Specify shaft size and length or specify bow weight and draw length and we will select proper shaft size.

**Bear®-Easton Professional arrows for precision target shooting X-7.**

**1810** Cut to length, fitted with insert target points and fletching of proper length for target shooting. Set of 8.

**1811** Full length with target points unattached and fletching of proper length for target shooting. Set of 8.

**Bear®-Easton Component Parts**  
Component parts for Bear-Easton Professional X-7 arrows are available in sizes 1516, 1616, 1716, 1814, 1816, 1914.

**1305 X-7** Full length shafts with points unattached. Dozens.

**1312** Insert target points only. Specify shaft size. Dozens.

**SPECIAL NOTE:** Bear-Easton Professional X-7 tournament arrows are available only at Qualified Bear Archery Service Dealers.

*40 Miles out on an ice pack during the filming of Fred's Polar Bear hunt for ABC Television's "The American Sportsman."*

*After 25 days on the Arctic ice Fred downed his Polar Bear 12 miles from camp. Actor Cliff Robertson was also in the party.*



## Aluminum

**Bear<sup>®</sup>-Falcon<sup>®</sup> Aluminum Arrows for target 24SRT-X** The Falcon is the economical arrow for the beginning archer; a practice and utility arrow for the expert. The Falcon offers plenty more quality and uniformity than any other shaft in its price range. James D. Easton makes the Falcon to precision weight and spine tolerances. Available in dozens and in these sizes and lengths only:

**1616** 20/30 lbs. 27" or full length  
**1716** 30/35 lbs. 28" or full length  
**1816** 35/40 lbs. 28" or full length  
**1916** 35/45 lbs. 29" or full length  
**2016** 35/45 lbs. 30" or full length

### Dozen

**1150** Cut to length, target points installed as indicated by sizes above. Proper fletching for target shooting.

**1151** Full length with diagonal fletching for target shooting, in above sizes. Target points unattached.

**1460** Full length shafts only. Target points unattached. Sizes listed above.

**1461** Falcon target points. Specify shaft size from above list.

\*Registered James D. Easton, Inc.

## Fiberglas

### NEW Bear Micro-Flite<sup>®</sup> Grayling Green "Plus 3" Target Arrows

Deliver top performance under all weather conditions. Rugged, lightweight Bear Micro-Flite shafts scorn moisture and temperature changes. Selected feathers are fletched to proper length and true helical for target work. Three different sizes—#2, #4 and #6.

Specify bow weight and draw length. Stocked in 27", 28", 29".  
**1025** Bear Micro-Flite tournament arrows fitted with insert target points. Dozen pack.

Bear Micro-Flite and Kodiak Glass Arrow component parts  
**1322** Nock inserts. Specify shaft size. Sizes #2, #4, #6, #7, #8, #9, #10.

**1323** Target points. Specify shaft size. Sizes #2, #4, #6. Dozen Pack.

**1324** Broadhead adapters. In sizes #7, #8, #9, #10. Dozen Pack.

**9071** Bear Micro-Flite Shafts. No points. Full length 31". Sizes #2, #4, #6, #7, #8, #9, #10.

Specify bow weight. Dozen Pack.

**1325 NEW Tuff-Tip**  
 Stop worrying about hitting those stumps. Fits over the end of your arrow between the fiberglass shaft and the Converta-Point. Virtually eliminates arrow splintering. Acts as a shock absorber. Packed in all Bear Microflite arrows. Dozen pack.

## Cedar

**Bear High-Grade Cedar Arrows** are for the novice and for the expert. Spine-matched to five-pound tolerance. Colorful cresting on tough, Port Orford cedar shaft. Feathers helical fletched in proper length for hunting, field, or target, specify bow weight and draw length.

**1060** Dozen pack. Target arrows in these lengths and weights:

26"—30/35, 35/40 lbs.  
 28"—30/35, 35/40, 40/45 lbs.  
 30"—40/45 lbs.

**1061** Dozen pack. Full length without points. 5¼" proper fletching for hunting and field in these weights: 40/45, 45/50, 50/55, 55/60 lbs.

**1062** Dozen pack. With 125-grain field point. 5¼" proper fletch for hunting, field shooting. In these lengths and weights:

29"—40/45, 45/50, 50/55, 55/60 lbs.

31"—40/45, 45/50, 50/55 lbs.

**1064** Dozen pack. Fred Bear four-blade Razorhead<sup>®</sup> hunting arrows. Specify bow weight and draw lengths. In these weights and lengths:

29"—40/45, 45/50, 50/55, 55/60 lbs.

31"—40/45, 45/50, 50/55 lbs.

**1065** Dozen pack. Matched set of six 125-grain four-blade Razorhead and six 125-grain field points. Same weights and lengths as 1064.

**1067** Flu-Flu<sup>™</sup> wraparound fletch, 125-grain blunt point. Length: 29". Weights: 40/45, 45/50, 50/55, 55/60 lbs. Box of four.

### Standard Grade Matched Cedar Field Arrows

**1082** Economical quality Port Orford cedar arrow for beginners in weights of 40, 45, 50, and 55 lbs. Assorted color shafts. Proper 3½" turkey feather fletching, colorful cresting, non-skid field point. 29" only. Specify bow weight. Dozen pack.

## Cedar

**Instant Archery<sup>™</sup> Arrows 1775** Replacement arrows for Instant Archery. Port Orford cedar colored shafts, Instant Archery crest. 28" length. Half-dozen pack.

### Port Orford Cedar Shafts

Parallel Port Orford cedar shafts, matched for weight and spine; 5/16" diameter for 30/35 lbs. only. 1½/32" diameter in 40/65 lbs. Spined at 28", 31" long. Specify bow weight and draw length.

**1300** 31" Port Orford cedar shafts, spine weight matched. Dozen pack.

**1301** Same as above, but in lots of 100.

### how to select correct arrow length

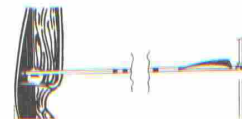

**first method** Draw a measuring arrow (marked in inches) in your bow. At full draw, your correct arrow length stops at the front of the arrow shelf.

**second method** Spread your arms straight to sides from shoulders, have someone measure the distance between your fingertips, then use this formula:



### Spread measurement

#### Drawing Length

spread-arm measurement	arrow length
57"-59"	24"-25"
60"-62"	25"-26"
63"-65"	26"-27"
66"-68"	27"-28"
69"-71"	28"-29"
72"-74"	29"-30"
75"-77"	30"-31"

The length of the arrow measures from bottom of nock slot to back of the head.

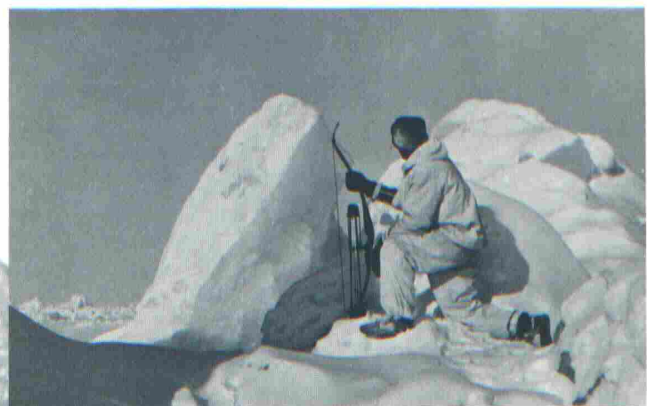
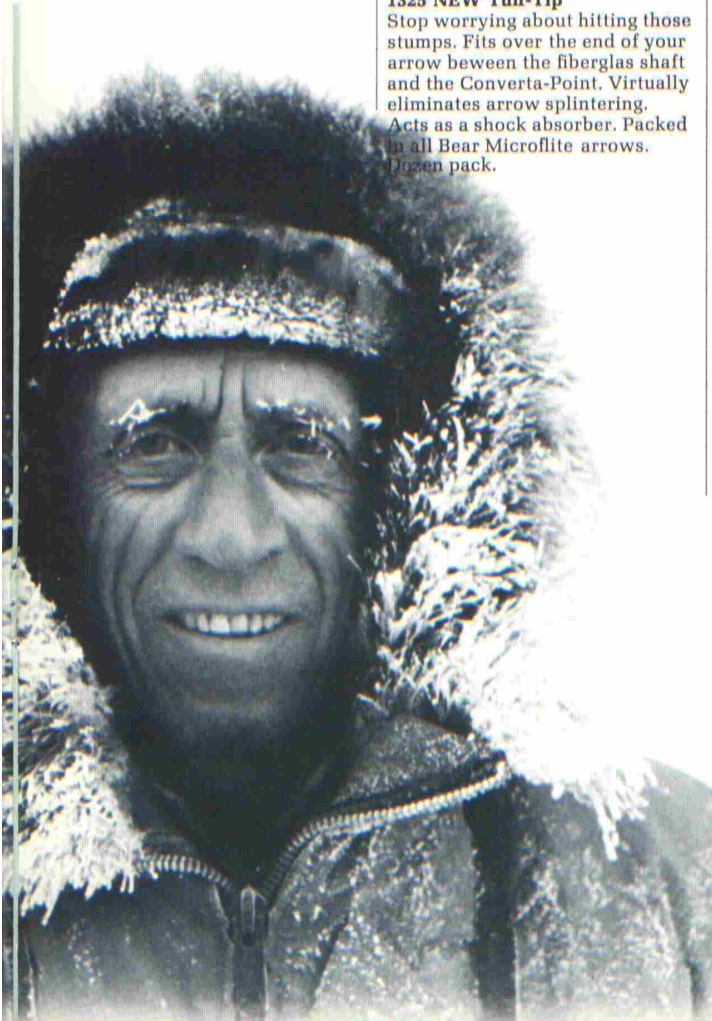

Stalking the Polar Bear from behind a pressure ridge.



## Bear® Quivers All Purpose

You know you have a Bear® quiver—now, and for years of rugged use to come. Skilled Bear craftsmen know what the archer needs—and how he wants it. For tournament, hunting, and field shooting. Take your pick. There's a Bear quiver for you. In top-grade, scuff-resistant vinyl. Handsome, functional designs.



**3726 Champion™ Back Quiver**  
A quiver for anyone in the family—large enough for adults, light enough for the kids. An economy quiver, it holds 12 or so arrows. Water 'n' scuff resistant red, white and blue vinyl. Accent cuff and shoulder strap. Specify right or left hand.



**3725 Big Bear® Back Quiver**  
Big Bear is back—in a rich vinyl with handsome gold trim. Big Bear is the quiver for all archers—in the field, at the line, in the woods. Roomy, and with a divider strap, Big Bear holds 18 to 24 arrows. Big Bear is adjustable, and ready for a big day. Stow your lunch in the accessory pocket, along with your rainjacket, shooting glasses, whatever else. Specify right or left hand.



**3730 Cheyenne™ Centerback Quiver**  
Centerback means it goes left or right handed. Sharp brown vinyl with contrasting cuff and pocket. Adjustable to your fast-action style with pack-type harness. It features a divider strap; holds 14 to 18 arrows for hunting or target. Zipper pocket invites the accessories—extra bowstring, broadheads, cement, camouflage cream—plenty of room.

## Tournament



**3735 Tournament™ Belt Quiver**  
Look good on the line. It's in smart black vinyl, scuff-resistant, holds 12 arrows, includes divider, belthook, ring, and a generous zipper pocket for your day's shooting needs. Specify right or left hand. For matching Bear belt, see page 37.

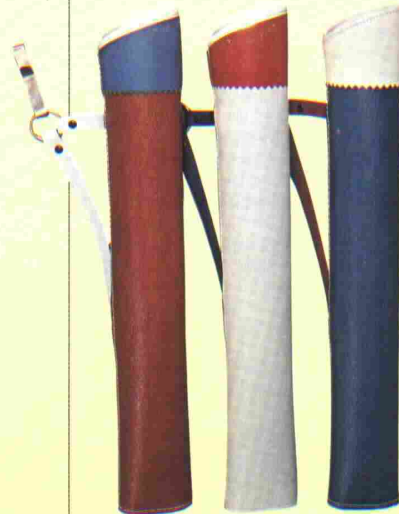

**3250 Mohican™ Belt Quiver**  
Low cost, yet of durable vinyl. Constricting vinyl cuff. Tote 8 to 10 arrows. Includes belt hook and ring. Random colors.

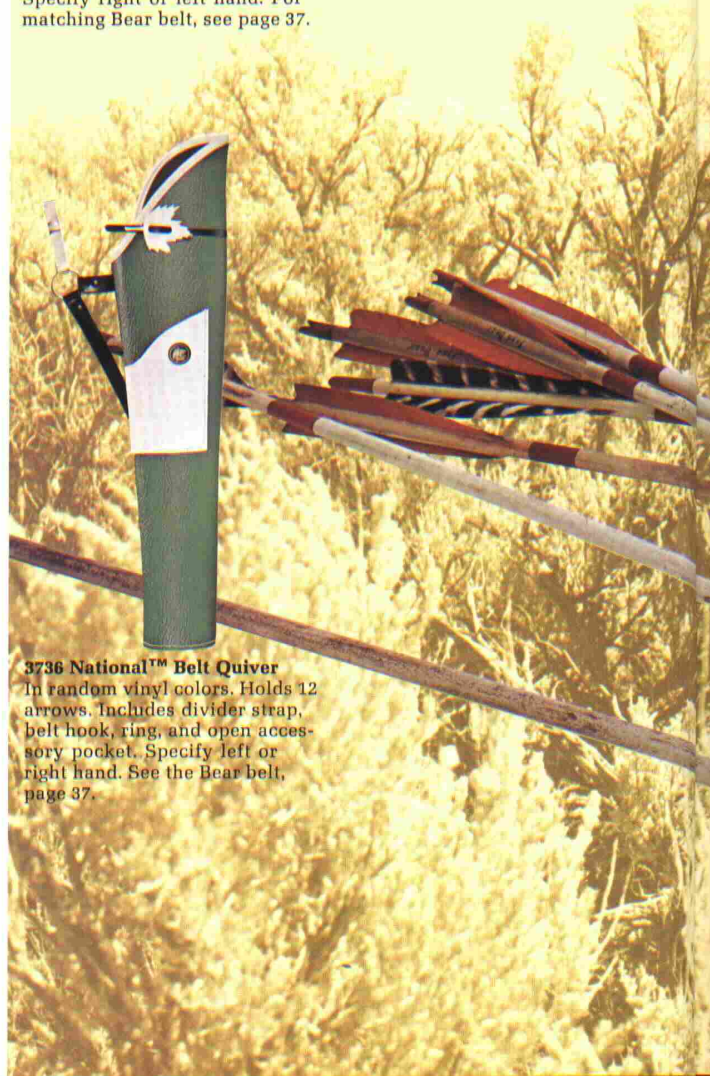

**3736 National™ Belt Quiver**  
In random vinyl colors. Holds 12 arrows. Includes divider strap, belt hook, ring, and open accessory pocket. Specify left or right hand. See the Bear belt, page 37.





**3255 Scholar™ Belt Quiver**  
Lucky beginner! Holds four to six arrows. Handy belt loop. Random vinyl colors.



**3740 The Talisman™ Belt Quiver**  
Take 10 to 12 arrows in the Talisman. Combines the best of side and hip quivers. Arrow separator and hidden belt tunnel. Carry extra string, tools, in the zipper pocket. Specify right or left hand. Tough vinyl, gold trim. Check the Bear belt, page 37.

**Hunting**



**3741 Talisman™ Hunter Belt Quiver**  
Split seconds count! Fastens to your belt ready for action. Holds six broadheads. Rubber dividers; foam rubber base. Belt tunnel and tie-down thongs. Specify left or right hand. Bear makes a belt, page 37.



**3731 St. Charles™ Back Quiver**  
The Bear exclusive left or right hand draw back quiver. Carry 14 broadheads for all-day shooting. Vinyl hood protects fletching; foam rubber base safeguards points. Adjustable chest thong and back harness makes for comfortable back carrying.



**3745 Huntsman™ Belt Quiver**  
The silent one—rubber dividers cut shaft rattle and fletching rub of your six hunting arrows. Foam rubber protects the points. Vinyl. Double belt loop. Use left or right handed. There's a Bear belt, too, page 37.

*Fred's first bow quiver, circa 1944. It was held in the bow hand along the back of the bow. Modern day bow quivers evolved from this first attempt.*

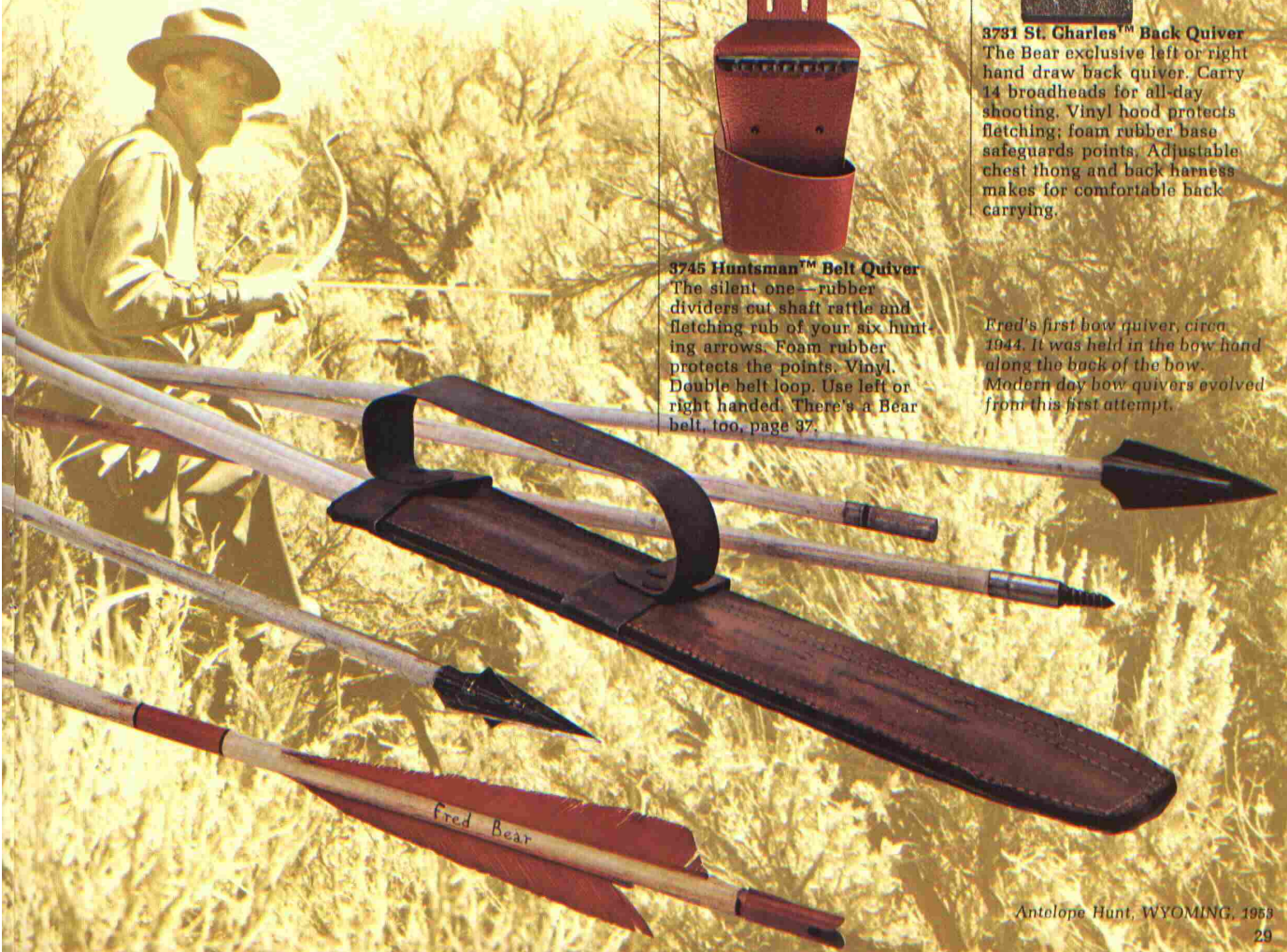



## Bow Quivers

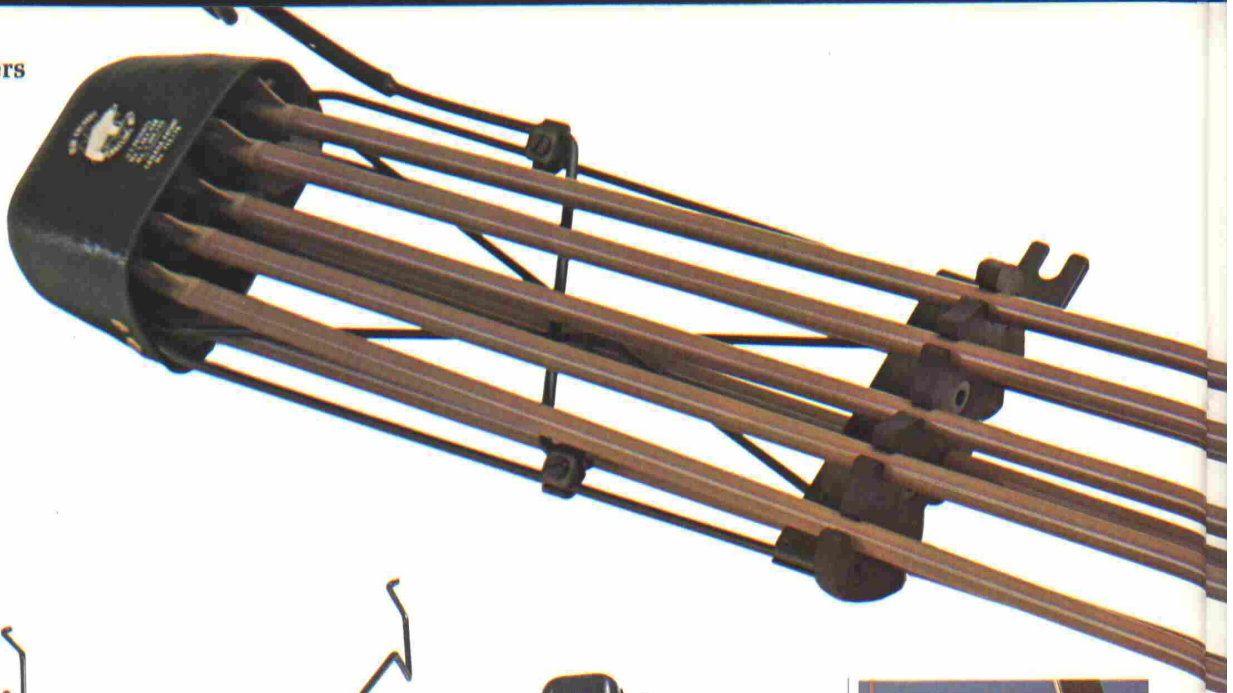

**3592 Fred Bear® Eight-Arrow Converta-Bow Quiver**  
Versatile, this quiver was originally developed for the Fred Bear take-down bow. Now, it fits any new Bear® laminated bow, any older Bear bow, and most other make bows, with a stabilizer bushing. Simple attachment. All you need is the Bow Quiver adapter kit (3593). Fits bows 48"-70". A screwdriver is all you need to fit it to almost any length bow. Eight arrows. Complete with instructions. Adapter kit not needed on any Bear Take-Down bow. Specify right or left hand.

**Safety note:** The Bear® four-arrow Converta-Bow quiver, the tape-on bow quiver, the eight-arrow snap-on bow quiver, and the Fred Bear eight-arrow Converta-Quiver share an important benefit: hunting points are held securely in a protective shield for safer handling. Safer for you. Safer for your arrows.



**3625 Fred Bear Four-Arrow Converta-Bow Quiver**  
Fits any Bear laminated bow with Converta-Accessory insert. Simply add the 3593 adapter kit and you have four arrows always at the ready. Specify left or right hand. Instructions included. Adapter kit not needed on any Bear Take-Down bow.



**7305 Bear Converta-Accessory Insert**  
Holds Omni-Coupler, Fred Bear hunting stabilizer, Fred Bear Converta-Fish reel. When you use the 3593 bow quiver adapter kit, you can mount the Fred Bear eight-arrow Converta-Bow Quiver or the four-arrow Converta-Bow Quiver. This insert is standard on all 1973 Bear laminated bows except Black Bear and Little Bear. To install on older Bear models, write our Custom Department.

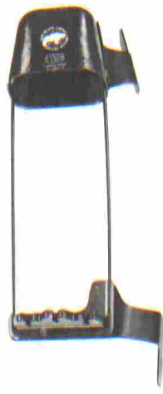

**3620 Tape-on Bow Quiver**  
Use ordinary adhesive or electrician's tape to mount this rigid two-point quiver to your bow riser. Holds four arrows. Simply wax this section of bow before taping. Tape included. Specify left or right hand. Adapt your bow to take the Converta-Bow-fishing rig and Converta-Quiver™. Nothing to it. Let us factory-install the Converta-Accessory insert (7305) at a nominal cost. Fits most Bear composite bows. See your Bear dealer, or write us direct. Bear bow quivers are covered by U.S. patent #3,209,740.



**3593 Bow Quiver Adapter Kit**  
Converts your bow with 1/4" stabilizer bushing or accessory insert to take the eight-arrow Converta-Bow Quiver and the four-arrow Converta-Bow Quiver. Also used with Omni-Coupler or hunting stabilizer. Leather pad protects bow finish.

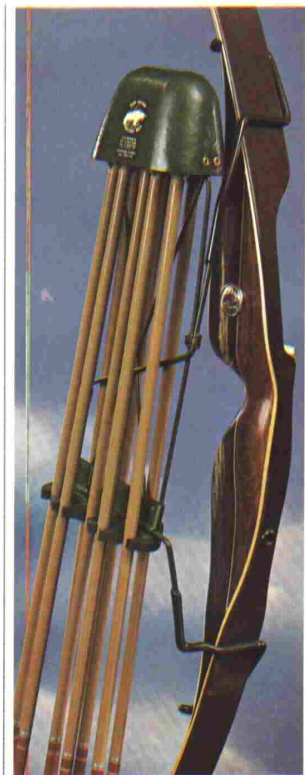

**3590 Eight-arrow Snap-on Bow Quiver**  
Snap-shoot quickly, easily, quietly, in the woods. The arrow is in your hand at a touch—eight arrows at your fingertips all day long. Two sizes:  
**3590S** Short, to fit most hunting bows from 52"-62". Best for short Kodiak Magnum®-type bow. Specify left or right hand.  
**3590R** Regular, to fit bows from 60"-64". Best for bows like medium-length Super Kodiak®. Specify left or right hand.



Kispiox River campsite, Dr. Rex Hancock, Frank Wiseman and Fred Bear. BRITISH COLUMBIA, 1963

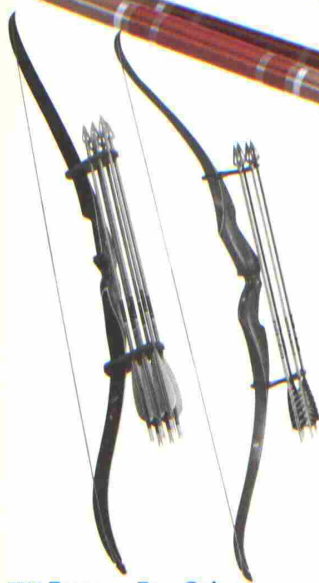
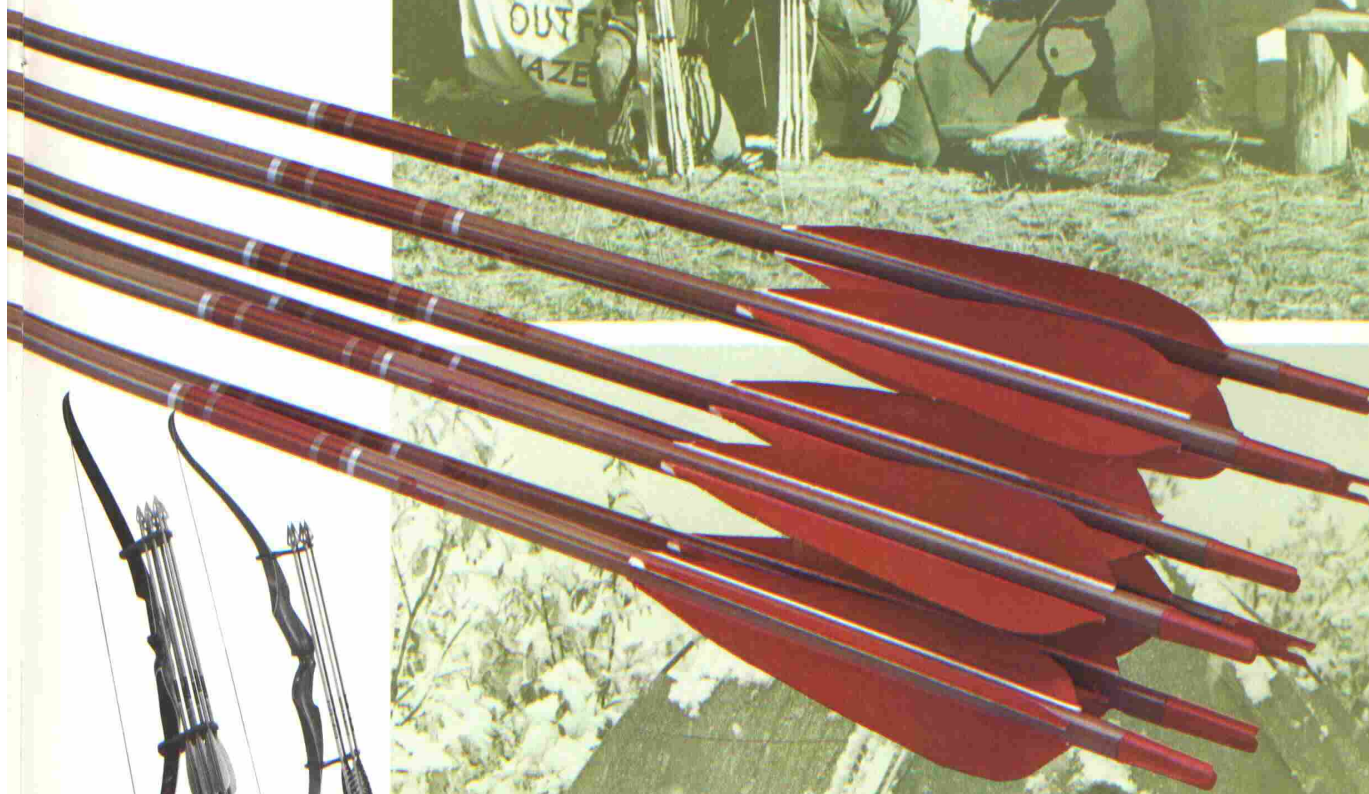

**7714 Economy Bow Quiver**  
Two-piece rubber quiver slips easily over bow limbs to hold six arrows. Weatherproof.

**7715 Deluxe Kwikie Kwiver™**  
Holds four arrows with special clamp that you mount or remove while bow is strung. Molded neoprene rubber mounts for shafts and bow limbs are reinforced with a special frame. One size for all bows. Fast, easy, arrow release.



Overnight snow, Little Delta River. ALASKA 1959.





Bowfishing for Lake Erie Carp, 1941.



Fred's first bowfishing reel, 1941

## Bear Bowfishing Equipment

The Bear bowfishing system is yours with a twist of the wrist. Your Converta-Bowfishing reel fits any Bear bow, and just about any other bow with stabilizer bushing. The spinning-type reel has no moving parts to wear out or to replace. And it's waterproof. The Bear harpoon arrow holds 'em fast.

### 3000 Bear® Converta-Bow-fishing Rig

Almost any Bear bow is ready for fishing whenever you are, with this new reel. It fits right into the accessory insert on all new composite Bear bows, except Black Bear and Little Bear. Complete with reel, 50' 90-lb. test braided nylon line. Fibreglas arrow with harpoon head, instruction book.

3005 The Bear Converta-Bow-fishing rig with 3060 Easy-off point.



3078

### 3010 Tape-on Bowfishing Rig

Fibreglas bow? Tape on your rig. Any other bow, too. Includes reel, 50' 90-lb. test nylon line, Fibreglas arrow with single barb.

3015 Same as 3010; easy-off point.

3030 Layfletched arrow with single barb point.

3035 Layfletched arrow with 3060 easy-off point.

3045 Layfletched arrow without point.

3050 Solid Fibreglas shaft only.

3078 Converta fish reel and line.

3082 Tape-on bracket, reel, line.

3090 Drum for fish reel.

3106 Bracket with screw for 3082.

3110 Extra nylon line, braided, 50' 90-lb. test.

3115 Layfletched, three-vaned, slip-on, molded rubber fletching for 5/32" and 11/32" shafts.



### 7915 Mac's Bowfishing Reel

This 11 1/4" diameter reel lets you aim and shoot with minimum drag, maximum accuracy. Simply tape padded brackets to bow. Clips secure arrow. Includes 70' 80-lb. test nylon line.



3055 Single-barbed harpoon head.



3060 Easy-off fish point, double-barbed harpoon head, screws on.

3065 Extra 3060 head.

3070 Extra 3060 shank.



7905 Al's fish slick retractable point. Moving barb loosens fish quickly.

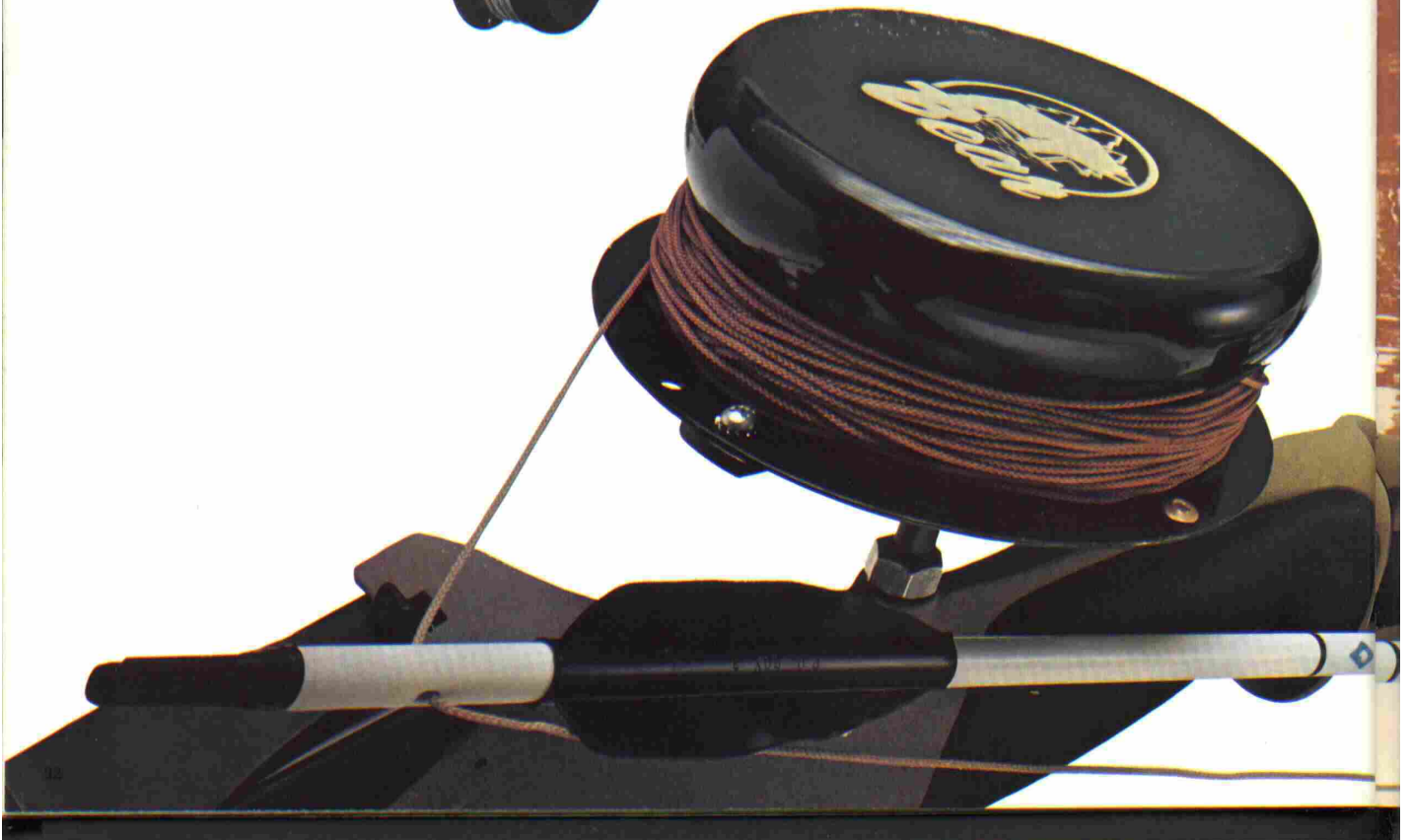





**3079 Screw-in Insert Adapter**

Adapt any 1/4" bushing to accept the Bear bowfishing rig, eight- and four-arrow Convert-a-Bow Quivers, Omni-Coupler® Stabilizer and Hunting Stabilizer.



Kisplox River campfire  
BRITISH COLUMBIA, 1963

The hunter relaxes on quiet water  
in a raft, Kisplox River, BRITISH  
COLUMBIA 1963.





**Gloves—Tabs—  
Armguards**



**3360 Contour-fit Pro™ Glove**  
Adjustable palm strap prevents slipping after release. Corfam®, single-seam design. Velcro® closure. Snug fit. Can be used right or left. Sizes 6-12.

- 6 ladies' small
- 7 ladies' med.
- 8 ladies' lge.
- 8 men's small
- 9 men's med.
- 10 men's lge.
- 11 men's x lge.
- 12 men's xx lge.



**3380 Master™ Glove**  
Soft contour design for comfort. Elastic back, closed-end tips, Velcro® closure. Elk. Sizes 6-12. Can be used right or left hand.



**Economical R & L™ Glove**  
Moderately priced right or left glove, open-end elkskin tips. Double-V seam. Sizes: ex. sml, sml, med, lge, x lge.  
3430 vinyl 3435 elkskin



**3330 Twin Tab™**  
Black Corfam®, smooth leather lining for clean release. Lge, med, sml. Specify right or left.

**3315 Single Tab**  
Same as 3330, in single thickness. Lge, med, sml. Specify right or left.

**3345 R & L™ Tab**  
Fits either hand. Assorted colors. Tough, smooth vinyl. Sml, med, lge. (Not illustrated.)

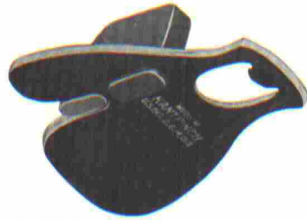

**7800 Kantpinch Tab**  
No more arrow pinch with patented finger separator. Shell cordovan, smooth leather back. Specify right or left. Sml, med, lge.



**7805 Wilson Tab**  
Adjustable finger loop. Smooth, heavy cordovan. Felt back. Sml, med, lge. Specify right or left.



**3490 Pickering™ Aluminum Armguard**  
Keep your cool and comfort. Contoured for a perfect fit. Colorful brushed aluminum. Adjustable straps, hook fasteners, 7" long.



**3445 Tartar™ Armguard**  
Snug fit, with elastic straps and fast-action hook fasteners. Tough vinyl, fully lined, reinforcing stay.

3450 Same as above, in leather.



**3455 Kool™ Armguard**  
Concealed spring steel in fully lined leather. Adjustable elastic straps, quick-action fasteners. Cordovan brown.  
3460 With instant Velcro® fasteners.



**3465 Ventilated Armguard**  
Cool comfort, reduces sweating, maximum protection. Velcro® fasteners and adjustable straps. Fully lined leather over spring steel wires, 6¾" long, brown or white.

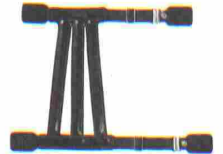

**3468 Mini-vent™ Armguard**  
The short version of 3465, 5½" long, cordovan brown or white.



**3470 Hunter™ Armguard**  
Extra wide for full protection. Fully lined leather for hunting. Spring steel stay. Three adjustable elastic straps, hook fasteners. Cordovan brown.

3475 With instant Velcro® fasteners.



**3480 Hunting Armguard**  
The length holds sleeves tightly in place. Spring steel stay covered with lined vinyl. Four elastic straps.

3485 Hunting armguard with instant Velcro® fasteners.

**Arrows—Caddies—  
Bowstrings—  
Miscellaneous**



**7787 Bear® Jumbo Arrow-Caddy**  
Stow four dozen arrows in foam padding, plus quivers, gloves, armguards—and a separate padded corner for bowsights. High-impact plastic case with handle and lock. Black, measures 33" x 14¾" x 5".



Sleepy early morning chef. ONTARIO, 1945.

Drying a sock. Blaney, MICHIGAN 1942.







**7786 Bear Compact Arrow-Caddy**  
 Holds 24 arrows in foam padding, plus your other gear in three adjustable compartments. Or take 48 arrows alone. Black, measures 32" x 5" x 5"; 4¼ lbs.



**3535 Bear E-Z Finger Sling**  
 Get a light and natural grip on your bow without binding. Slips on and off instantly. Soft leather. Small and large.



**7031 Fred Bear Deluxe Snap-on Bowsling**  
 Expands to fit any bow without adhesives, holes, or screws. Can't mar finish. Snap on and off. Black topgrain cowhide.



**3530 Universal Bowsling**  
 Improve your aim; achieve positive bow control with this soft leather sling. Fits any bow. Brown or black leather.

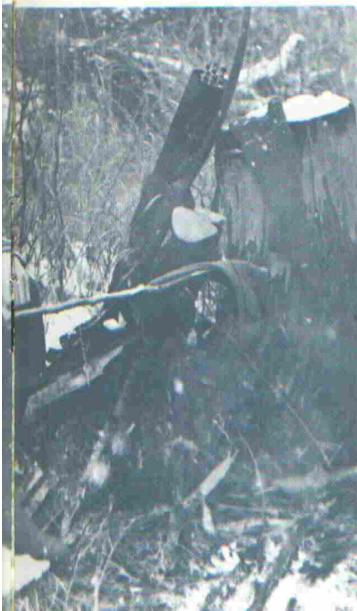

**3540 Bear Bow Saddle**  
 Soft leather pad cushions hand for comfortable, non-slip grip. Can be trimmed to fit any hand and bow contour. Adhesive peel-tab backing.



**3542 Bear Shirt and Blouse Protector**  
 Heavy-duty white or black lined vinyl protector to keep clothing away from arrow or string. Hook, ring fastener, leather strap with flexible elastic section. Small and regular. Specify color, size, right or left.



**Fred Bear Showed Me How T-Shirts**  
 Attractive full color T-Shirt. Sets you apart as an archery expert. A real conversation starter. To order, send check or money order directly to Bear Archery, Rural Route One, Grayling, Michigan 49738 in the amount of \$2.00 for each T-Shirt wanted, we pay postage. Michigan residents add 4% sales tax.  
**Adult Sizes:** Catalog No. 8700, Specify size: small, medium, large or extra large.  
**Youth Sizes:** Catalog No. 8701, Specify size: small, medium or large.  
**Juvenile Sizes:** Catalog No. 8702, Specify size: small, medium or large.  
 Please print your name and address.  
 Allow two weeks for delivery.

## Bowcases



**3501 Fred Bear Master Take-Down Bowcase**  
 Fred Bear designed it; it's the finest Take-Down bowcase available. In briefcase style, it takes the bumps wherever you go. Fits under airplane or car seat. Bow is well-protected on all sides, top, and bottom, in Polyurethane foam. Heavy-duty zipper on three sides. Won't mar or tear, scorns weather, wipes clean with damp cloth. Two gold Bear medallions mark the archer. Measures 24" x 8½" x 2". For all All-Purpose Sport handle sections and one set of limbs.



**3502 Fred Bear Take-Down Bow Travel Case**  
 Black expanded vinyl outside, soft red flannel inside. Top quality throughout. Holds any Take-Down bow handle section and one set of limbs. Three-sided zipper for full openings. Take it traveling, to the tournament, to the woods. Measures 29½" x 12".



**3505 Bowcase**  
 Years of rough use are built into this expanded vinyl case. Reinforcing stitchwork. Fleecy nap double lining. Black leather-grained exterior. Reinforced handle, extra-long zipper closure. Width: 8"; lengths: 48", 52", 60", 66", 72". Bows 48" and under fit into 48" cases; bows 50" to 52" fit into 52" cases; bows 54" to 60" fit into 60" cases; bows 62" to 66" fit into 66" cases; bows 68" to 72" fit into 72" cases.



**3510 Bowcase**  
 Rich-looking leather-grained vinyl—yet at a low price. A quality case with carrying handle, reinforced stitching. Black 6¾" wide, 52", 60", 66", 72" lengths. Bows 48" to 52" fit into 52" cases; bows 54" to 60" fit into 60" cases; bows 62" to 66" fit into 66" cases; bows 68" to 72" fit into 72" cases.



**3515 Bowcase**  
 Bright gold cotton twill. Heavy napped back. Vinyl binding. Lengths 60", 70"; 4¾" wide.



## Points



**7341 Blunt 7347 Field Five-degree Taper-hole Points**  
Machined steel standard-tapered field and blunt points for hunting practice. Interchangeable with broadheads. For  $1\frac{1}{32}$ " shafts, 125 grain. Dozen.



**Miracle Converta-Judo Point**  
End arrow loss! The magic spring arms dig in to prevent ricochet and burrowing. Stands in tall grass. Full speed, straight shooting, explosive impact. Now with Converta-Point® adapter installed.

**7372**  $\frac{5}{16}$ " for aluminum and cedar Converta-Point® arrows  
**7373**  $1\frac{1}{32}$ " for Fiberglass Converta-Point® arrows  
**7370**  $\frac{5}{16}$ " Judo point without adapter  
**7371**  $1\frac{1}{32}$ " Judo point without adapter

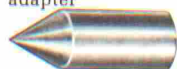

**Parallel-hole Target Points**  
**1500** Steel,  $\frac{5}{16}$ " outside diameter, 15 grains.  
**7353** Brass bullet  $1\frac{1}{32}$ ".



**7361 HTM Blunt Points**  
Shoot safely in confined areas, or for small game. Tough rubber point fits over  $1\frac{1}{32}$ " squared-off shaft end or over metal blunt point. 125 grains, half-dozen pack.



**7379 Bod-Kin Hunting Points**  
Three blade hunting head fits any hunting shaft,  $\frac{21}{64}$ " ferrule size, 125 grains, three to a pack.



**1340 NEW WACA** high strength Wooden Arrow Converta-Point Adapter for  $1\frac{1}{32}$ " shafts only. 5 degree tapered magnesium. Dozen pack.



**1325 NEW Tuff-Tip**  
Stop worrying about hitting those stumps. Fits over the end of your arrow between the fiberglass shaft and the Converta-Point. Virtually eliminates arrow splintering. Acts as a shock absorber. Packed in all Bear Microflite arrows. Dozen pack.



5115



5237

## Bear Razorhead®

Lethal. It's a four-blade razor-sharp broadhead combining two precision-honed blades. The main blade is mill-tempered spring steel, silver-brazed to a one-piece steel ferrule, then honed. The lightweight razor-steel auxiliary blade is easily replaced. Sharp-ening instructions with package, and on page 44.

**5115** Three-pack Fred Bear single-blade Razorhead and three auxiliary blades.  
**5114** One dozen Fred Bear single-blade Razorhead, one dozen razor-auxiliary blades, slot cleaning tool. (Not illustrated.)

**5237** Three-pack "Plus 3" Converta-Point four-blade Razorhead with attached broadhead adapter. 145 grains.

**5234** Dozen pack "Plus 3" Converta-Point Razorhead with attached broadhead adapters, plus one dozen auxiliary blades, and slot cleaning tool. (Not illustrated.)

**5121** Dozen pack auxiliary blades. Extra insert blades for all Razorhead. Weight 10 grains each. (Not illustrated.)

The Fred Bear Razorhead® is covered under United States patent #2,829,894.

## Nocks

**7000 BJORN Nocks** Sizes  $\frac{1}{4}$ ",  $\frac{5}{16}$ "



**7005 Fred Bear® Speed Nocks**  
Fast-loading, deep open-throat speed nocks. Reinforced edges. Injection-molded butyrate in blue, black, yellow, white, red. Sizes  $\frac{1}{4}$ ",  $\frac{5}{32}$ ",  $\frac{5}{16}$ ",  $1\frac{1}{32}$ ".



**7270 Nock Locks**  
Fast guide to position arrow consistently. Pairs.



**7733 Nok-Set**

Aluminum handlined with live plastisol. Slip-proof. Positive, permanent nocking point. Package of five.

**7732**

Three Nok-Sets, with pliers.



**7269 Bear® Nocking Points**  
An instant nocking point. Heat-shrinks onto string. Four points per package.



**7273 New! Bear-Glue™**  
Eliminates need for finger protection, yet gives positive nocking point time after time. Special new material will not slip or damage string. Two sets per package.



**7865 Potawatomi Bow Square**  
Find your correct nocking point and bracing height—the first time. Lightweight, non-corrosive aluminum.

*Fred introduces Dan'l Boone (Fess Parker) to the bow and arrow. The two hunted together for the filming of the ABC American Sportsman television program. Kispiox River, BRITISH COLUMBIA 1965.*





## Bowstrings



**7105 Fred Bear® Professional Bowstrings**  
Extra-strong double-loop black Dacron®, full monofilament serving and loops. Handsome plastic carrying case. Hand-rubbed strands in custom lengths for bow weights 25/35 (10 strands) and 35/45 (12 strands). Lengths: 63", 66", 68", 69", 70", 72".



**7101 Single-loop Bowstrings**  
For all bow lengths and weights to 40 lbs. Single-loop braided Dacron® with center serving.



**7035 New! Bear® Universal Temper Strand Bowstrings**  
Get top performance from your target bow with this improved bowstring for all target bows up to and including 35 lb. Hand-rubbed, double-loop white Dacron®, with yellow serving. Lengths: 60", 62", 63", 64", 66", 68", 69", 70", 72".

**7036**  
Same quality as 7035. White Dacron® with white serving. For 36 lb. to 50 lb. target bows in lengths: 60", 62", 63", 64", 66", 68", 69", 70", 72".

**7050**  
The new, improved bowstring for hunting bows up to and including 50 lb. Black Dacron® with black serving. Lengths: 48", 52", 54", 56", 58", 60", 62", 63", 64", 66".

**7051**  
Same quality as 7050. For hunting bows 51 lb. to 70 lb. Black Dacron® with green serving. Lengths: 48", 52", 54", 56", 58", 60", 62", 63", 64", 66".



**7850 Three Bear® Bowstringer**  
The safest way to string a bow. Simply stand on cord after attaching bowstring to bow tips. The limbs don't twist. So safe and easy. Imported calhide pockets and nylon cord. Also works on bows with bow tip protectors.

*Fred tries on Dan'l Boone's coonskin hat. BRITISH COLUMBIA 1963.*



**7060 Fred Bear® String Server**  
With black nylon thread. Hook over string for fast serving. Enough here for 60 servings.

**7061** Server with monofilament thread.

**7062** Nylon thread only; red, yellow, black.

**7063** Monofilament thread only.



**7052 Super Dacron® Bowstring Thread**

Do your own thing. Make bowstrings from four-ounce spools of super Dacron® thread. B-43 pre-waxed fibre, white only.



**7057 Fred Bear® Bowstring Wax**

Get more wear from your bowstrings by waxing them frequently. Designed especially for synthetic fibers. In convenient pushout tube.



**3580 String Keeper**

Protects string and bow nocks. Bowstring can't twist. Ensures correct brace height. Leather, adjustable elastic strap. For any bow.



**7845 Bow Tip Protector**

Holds bowstring in place on lower limb. Protects tips from damage. Wear-resistant plastic. Fits any bow.



## Storage Aids



**7076 Bow and Arrow Wall Rack**

Put this hardwood beauty together in five minutes. Metal wall hangers, special accessory hooks. Show off three bows, 24 arrows.

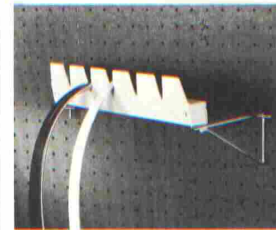

**7071 Wall Bow Rack**

Spacesaver; bow saver. Relieves pressure on bow limbs to prevent warping. Holds five bows on 16" wall space or pegboard. Hardware included to mount flush or at angle on pegboard.



**High Quality Bear® Belt**

Complement your Bear accessories. Top-grain leather; cut to your own size. Distinctive Bear medallion on gleaming buckle face.

**3270** buckle only, 1"

**3275** black lizard, 1½" wide

**3280** buckle only, 1¼"

*Trick shots for the ABC camera crew. BRITISH COLUMBIA 1965.*



## Bowsights Target

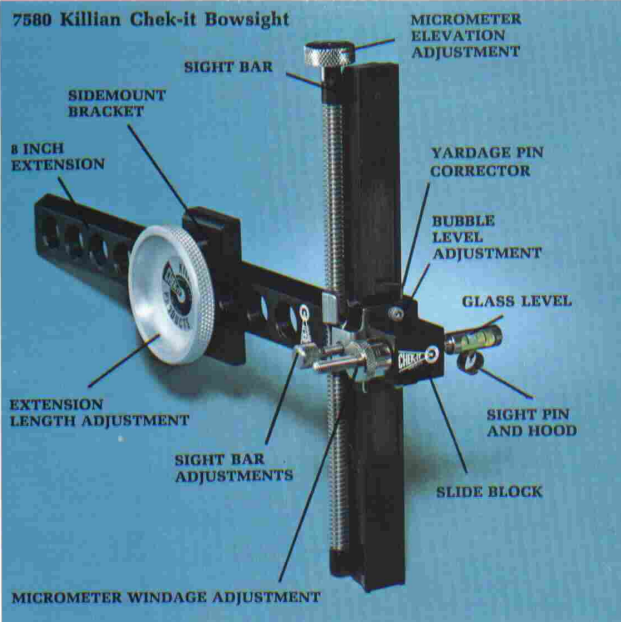

### 7580 Killian Chek-it Bowsight

This is the world's finest bowsight in the opinion of most of the professional archers. More than 1/2 the shooters at the recent PAA Nationals here in Grayling used this sight.

Chek These Features:

- Micrometer Windage Adjustment—allows you to tailor your shooting for local weather conditions.
- Yardage Pin Corrector—Even though the pros preset their sights for given yardages actual shooting conditions often require minute changes.
- Micrometer Elevation Adjustment—This ingenious device permits you to fine tune your bow.
- Bubble Level Adjustment—
- Extension Length Adjustment—shooting conditions, yardages, indoor vs. outdoor targets can require changes in the sight location.
- The sight pin and hood are made of durable stainless steel.
- Accurate glass level.
- Slide Block, Sight Bar and 8 inch extension are made of black anodized aluminum.
- Works right or left handed.
- Side mounted for more sight clearance.

Note: The Killian Chek-It Sight comes with conventional side mount and special Bear mount that will fit most Bear Bows.

- Complete mounting instructions for all bows included with sight.

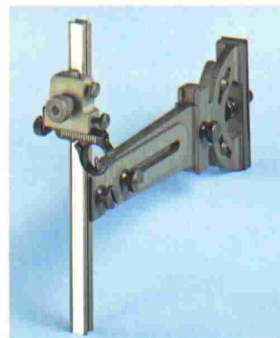

### 6300 Bear-Jeffery Omni-Bowsight™

When Vic Berger shot off three consecutive rounds, he came within one point of a perfect 900 score. This is the bowsight he used. Need more? A standard bowsight with micrometer windage adjustments with friction lock, positive slide elevation adjustment. Elevation compensation adjustment pointer. Coarse elevation—simply move slide bar in base anvil. Adjustable to parallel string in horizontal and vertical planes. Precise, factory-located mounting to attach to most Bear target bows. Install on almost any bow. Follow instructions carefully. Use template with sight, when purchased as an accessory.

For precision competitions, check the adjustable sight extension, an accessory to the Bear-Jeffery Omni-Bowsight.

### 6310 Adjustable Sight Extension

Compensate for your shooting habits, such as excessive torque, inconsistent bow hand pressure, and draw length.

### 6175 Fluorescent Dot Post

The aperture is standard equipment with the Bear-Jeffery Omni-Bowsight.



### 6050 Fred Bear® Premier Bowsight

Now, set for windage and elevation with the only bowsight that's custom-designed to be an integral part of your bow. Right on target every time. With the adjustable nylon arrow plate, you tune your bow to the spine of the different arrows, and to your own shooting style. A wide choice of accessory apertures and arrow rests, too. Available in 5" and 7". The 6175 fluorescent dot post and the 6200 bristle rest are standard.

Replacement and accessory parts for Bear bowsights and Premier arrow rests are available at your local authorized Bear dealer.

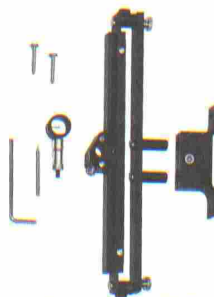

### 7546 Deluxe Pro-Bo-Sight

Fully adjustable sight—that can be removed instantly from stored bow—and remounted without changing calibration or sight alignment. Mounting base remains on bow. Cants right or left on top or bottom. Elevation adjustments always stay in place, yet can be changed without turning a locking screw. The Pro-Bo-Sight extension attaches to the Deluxe in perfect position and alignment every time.



### 7547 Pro-Bo-Sight Extension

Attaches to 7546 Deluxe Pro-Bo-Sight. Compensates for various shooting differences in torque, draw lengths, hand pressures.

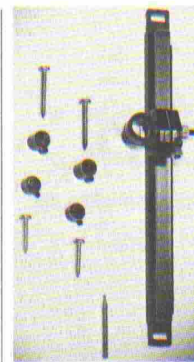

### 7545 Standard Pro-Bo-Sight

Fully adjustable. Cants right or left on top and bottom. Move it straight across right or left. Elevation adjustments stay in place—no need for locking screw to make changes.

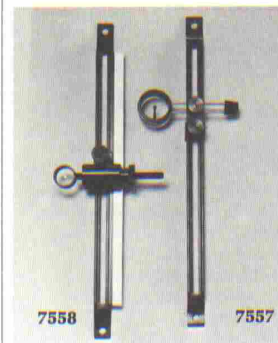

### Bear® Scor-Mor Sight

**7558 Deluxe Target and Field Sight** that has all the features of sights selling for two or three times as much. Micro windage and elevation adjustments.

**7557 Field, with hood and post.** Makes smooth sight adjustments, with unique design of polyethylene and anodized parts.



### 7670 String Peep Sight

Put this on your string, and you have a rear sight for perfect alignment. Unbreakable vinyl, weatherproof.







**Bear® optional accessories**

These accessories are available for Bear bowsights and for Bear Premier Arrow Rest:

- 6165 Peep sight
- 6175 Fluorescent dot post
- 6265 Cross hair aperture
- 6312 Fluorescent Dot Post with Level
- 6200 Bristle rest
- 6210 Nylon rest
- 6205 Feather rest (specify right or left)
- 6125 Slide receiver assembly for 6110
- 6110 Premier aperture slide assembly (regular or short)
- 6245 Hunting aperture and slide assembly
- Bear Premier bowsights, the Premier Arrow Rest, and related sight accessories are covered by U.S. patents 3,318,298 and 3,120,222.
- 6160 Magnetic retractable rest—the finest rest in archery for vanes and feathers.
- 6115 Aperture slide screw

**Hunting**



**6105 Bear Premier Hunting**

Preset your sight for three known distances and you're ready for that critical one-time-only shot. This fine sight becomes an integral part of your bow; it's built in to fit perfectly. In this five-inch sight you get a 6200 bristle rest, an adjustable nylon arrow plate to tune arrows properly, and three fluorescent posts you preset for the three yardages. Besides these, you can choose various accessory apertures, rests, and additional fluorescent post assemblies from the Bear optional accessories selection

**6100** Field model 3¾" hunting sight—fits Victor Magnum® handle section.

**6105** Field model 5" hunting sight—fits Victor Kodiak® handle section.

5" sight may be used on Super Kodiak up to 50 lbs.

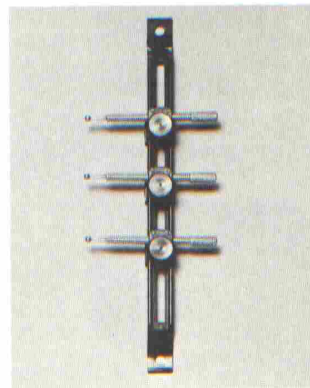

**7560 NEW Shur-hit Hunting Sight**

Preset any yardage; 15, 30, 50, for example. The three sighting bars adjust easily. Locks securely with thumb screws.

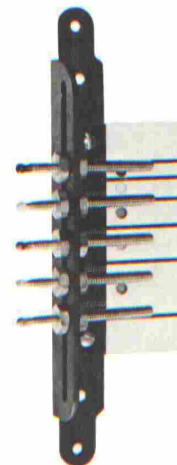

**7618 Rain-Bow Hunting Sight**

The built-in range finder lets you preset five distances. Simply use the clearly visible color-coded pins—blue, yellow, red, white, black. Installs easily on any size bow.

Mozambique respite, Camp Ruark, AFRICA 1964

Television Star Arthur Godfrey and Fred Bear arrive in Mozambique, AFRICA in 1964. It was during this safari that Fred downed a four ton elephant with one arrow from 40 yards.

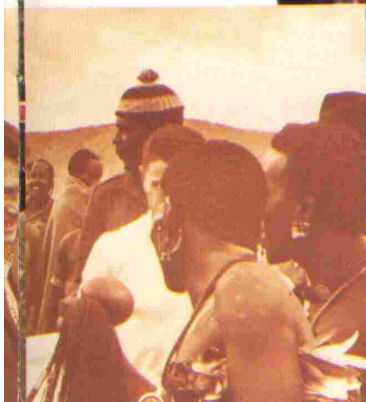



## Omni-coupler Stabilizer



### 7310, 7311, 7312 Bear® Omni-Coupler™

Give your arrow a truer flight; improve your accuracy. This is a dramatic advancement in stabilizers. It permits the bow to move at the "moment of paradox" as you shoot. While your bow moves, the lightweight tube and weighted head of the Omni-Coupler stay put. The device counteracts the shock and vibration of the limbs after arrow release, for a faster dampening action. Select the right combination of color-coded interchangeable compressible bushings, two interchangeable heads, and lightweight tubular rod to complement your own style.

**7310** Bear Omni-Coupler with tubular rod and two weighted heads; carrying case.

**7311** Bear Omni-Coupler with two interchangeable compressible bushings. Red, soft action; black, stiff action.

**7312** Bear Omni-Coupler with two interchangeable compressible bushings with  $\frac{1}{4}$ " stud to fit other bushings. Red, soft action; black, stiff action.

**Also available:**  $\frac{1}{4}$ " stud to fit other bushings and stabilizer rods.

The Bear Omni-Coupler is covered by United States patent #3,524,441.



### 7320 Bear® Hunting Stabilizer

Improve accuracy. Reduce string noise. Cut bow movement. Get a better arrow clearance. Improve the feel—all with this compact stabilizer. Chrome-plated weighted head and built-in flexible coupler. Fits any 1972 composite Bear bow except Black Bear and Little Bear. Just  $3\frac{1}{2}$ " long, with camouflaged case for hunting. With the  $\frac{1}{4}$ " 3079 adapter, you can add the Bear hunting stabilizer to other make bows with  $\frac{1}{4}$ " stabilizer bushing.



### 7624 Adjust-a-level

Fits any place on bow to eliminate accidental canting. Self-adhesive, no drilling.

## Arrow Rests—Aids



**6255 Bear® Premier Arrow Rest**  
Tune your bow to your arrows—and to your own style—with this handsome combination bristle rest and nylon adjustable arrow plate. Fits any bow. Adjusts easily. Complete instructions included.



**6160 Bear Premier Magnetic Arrow Rest.** Eliminates arrow drag. Rest retracts away from arrow at moment of release. Includes cadmium plated flipper, bar pin, magnet and rubber bumper.

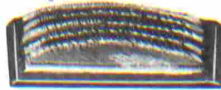

### 1520 Feather Arrow Rest

Protect your arrow crestings; get a friction-free release. Fits any bow with an arrow rest shelf. Five contoured feathers. Measures  $\frac{3}{8}$ " wide,  $1\frac{1}{8}$ " long,  $\frac{1}{4}$ " high. Self-adhesive.

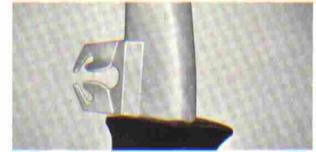

### 7282 Arro-Guide Arrow Rest

Ideal for all bows not equipped with arrow shelf. Fits all glass or wood bows. Plastic fingers hold arrows with no harm to feathers. Adhesive back, for right or left hand, easily removed.



### 7210 Bear® Premier Flex-rest

Use in combination with Bear Premier sight plate or 6255 Premier rest. Specify left or right. Self-adhesive.



### 7283 Hoyt Pro Rest

This rest provides for positive clearance of vanes and feathers. Non-interfering rest with pressure plate. Retaining finger holds arrow in place. No arrow bounce. Self-adhesive. Specify left or right.







**3555 Bear® Bristle Rest**  
For hunting, field. Installs in seconds on any bow, left or right.



**3560 Bear® Feather Shelf Rest**  
For field or target. Specify left or right.



**3565 Bear® Nylon Shelf Rest**  
For left and right hand. Self-adhesive back.

The Kush-Kush Man (witch doctor) tries to console Fred, thinking that he hunts with a bow and arrow because he cannot afford a gun. Mozambique, AFRICA, 1964.

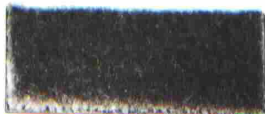

**3572 Bearhair™ Arrow Rest and Bear® Silent Arrow Plate**  
Available in combination only. The Bear Pre-furred adhesive-backed arrow plate deadens the sound of drawing a hunting arrow. And the Bearhair arrow rest helps achieve a smooth, quick, quiet draw and release when you hunt. Self-adhesive back. A dynamic duo.



**3575 Bear® Leather Silent Arrow Plate Only**  
Same as Pre-furred silent arrow plate, only in leather.



**6275 Berger Button**  
Vic Berger is the first archer ever to shoot perfect 300 rounds — back-to-back. He likes this adjustable arrow plate, for now tuning a bow is as simple as turning a set screw. It's a spring-tension Teflon® pressure point that works like a shock absorber to minimize the effects of a bad release. Simply dial the correct amount of center shot you want — like focusing a fine camera. Install it yourself, or have Bear's Custom Service Department do it for you.



**7281 No-Freez Klicker**  
You hear the click at full draw, to prevent your freezing and to improve your technique. Chrome-plated spring steel. Adhesive back.



**7279 Kisser Button**  
This sweetheart touches your lips when you've reached full draw. Attach to bowstring for consistent shooting.

## Powders—Cements



**7015 New Bear-Cote®**  
Protect your bow with this fantastic new polymer coating. Especially good on laminated products such as bows and skis. Prevents deterioration due to ultra-violet rays and protects against the elements. Keeps your bow new looking. 1 1/4 oz.

**7211 Bear Shooting Glove Powder**  
Eliminate sticky fingers. Apply to shooting glove or to tab for a friction-free silk-smooth release. Spray on sweaty hands. Squeeze-bottle dispenser, 3/4 oz.



**3525 Powder Pouch**  
Hook onto your belt. Refillable, clip for score card clear vinyl flap. Custom made.



**7021 Bearfast™ Archery Cement**  
The quick-drying, water-proof, flexible cement for feathers, nocks. Squeeze tube, 1 3/4 oz.



**7023 Fletch Tite**  
Adhesive for feathers. Long-lasting, fast-drying, squeeze tube, 3/4 oz.



**7024 Ferr-L-Tite Cement**  
For points and ferrules. Apply with heat. Doesn't get brittle. Squeeze tube, 3/4 oz.



**7025 Bear Quick Stick™ Cement**  
Apply with heat. Dries quickly without becoming brittle. Approx. 1 oz.



**7028 Point-Fast Adhesive**  
Points stay put with two-stage fast-drying, brittle-free adhesive. Plastic bottles, 1 oz.

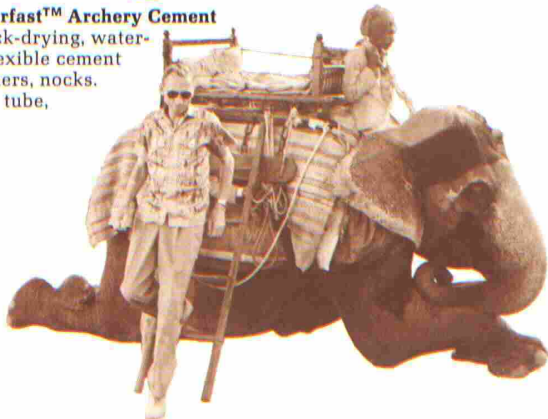

An unusual taxi, Rosie the elephant. Taken in the Palace yards when the guest of the Maharajah of Bundi. Fred downed the mighty Bengal Tiger during this trip. Phoolsagar Palace, Bundi, INDIA, 1963.



Writing his field notes during the heat of the day, Mozambique, AFRICA, 1965

Witch Doctor putting magic on Fred's bow, Mozambique, AFRICA, 1965.





Archers from the Detroit area assemble in White Cloud, Michigan prior to the first archery bowhunting season in Michigan, White Cloud, MICHIGAN 1937.

## Hunting Accessories

### 7260 Bowhunter Gloves

Deerskin gloves for warmth, style, action. Leather-tipped shooting fingers (specify left or right). Alderbark brown. Sizes 7, 8, 9, 10, 11.



### 3130 Fred Bear® Bowhunter's Kit

Compact and ready to use. Includes hunting knife with impact-proof handle, file and stone for sharpening broadheads, extra pocket for bowstrings. High-quality knife blade extends fully into decorated bone handle.

### 3132 knife only

### 3140 file case; top grade leather with belt loop

3145 sharpening stone; best quality for knife and Razorheads

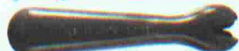

### 7255 Fred Bear® "Cutmaster" Knife and Broadhead Sharpener

Get the edge—a real cutting edge—on any knife or broadhead. Weighs ¼ oz. Small enough to slip into your pocket.



### 7257 Neet Broadhead File

Great for the field. Vinyl carrying case included. About the size and weight of your ballpoint.



### 7138 Camouflage Bow Cover

Two-piece cover to slip over bow limbs. Conceals without hampering your shot.



### 7300 "Compleat" Bowhunter's Accessory Kit

Completely forgetproof hunter's kit. The package has everything: knife and Razorhead sharpener, Bear-Gluv, Bear bow stringer, slip-on camouflage bow cover, Kwik-Lok arrow holder, brush buttons, string silencers, rubber bowtip protector — and complete instructions.



### 7723 Kwik-Lok Arrow Holder

Virtually automatic; great for cold hunting days. Kwik-Lok holds arrow nocked in the bow ready for that quick shot. Draw, and it releases automatically, then springs clear of arrow's flight. Self-adhesive.

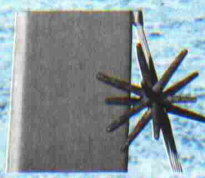

### 7838 New "Mity Quiet" String Silencers

Don't spook game when you shoot. Twin rubber-like burrs wind into bowstring ends. Kills twang sound. Two sets per pack.



### 7830 Brush Buttons

Prevent snagging on underbrush. Kills string noise, yet does not interfere with bracing or accuracy. Slip two soft rubber buttons onto bowstring. Two sets per pack.



### 7160 Fred Bear® Camouflage Make-up Cream

Blend in with the woods. Three colors: Bark Brown, Glade Green, Shadow Black cream, for face, hands, bow. Even has insect repellent. Cold cream base, applies easily.



### 7222 Cutter Insect Repellent

Three drops of Cutter's cream formula thwarts gnats, mosquitoes, ticks, black flies. Won't rub or sweat off. Economical and long-lasting.

### 7238 Rickard's Indian Buck Lure

Hides all human scent from deer, elk, moose, bear—guaranteed. Even downwind. Plastic pocket size squeeze bottle.



### 7823 Bear® Archery Patch

Identify yourself. Ideal for club shooters, teams. Embossed back patch, official Bear emblem in green, black; 7" diameter for jackets, shirts.

### 7824 Shoulder Patch

Same as above in 3" diameter.



### 7827 "Fred Bear Showed Me How" Shoulder Patch

Answers the obvious question for you when you step back from the line, or return from the woods or field with your game. Three-inch sew-on patch.



### 7828 "Bowhunting Spoken Here" Shoulder Patch

A three-inch patch that makes points in any conversation. Sew it on your hat or jacket.

### 7971 "Bowhunting Spoken Here"

Transfer decal, 8" x 3¼", for car window, rec room, trailer, etc. (Not illustrated.)



## Targets



7381



7380



7383



7382



7384

### Fred Bear® Life-sized Animal Targets

Shoot at them, or admire them; for field or den. Artwork in sepia tone. All 35" x 45".

- 7380 white tail buck, rear view
- 7381 white tail buck, eating
- 7382 standing buck
- 7383 running buck
- 7384 white tail doe, running
- 7385 set of all five



### New!

7386 standing buck, with vital organs and bone structure outlined



7502



7504



7503



7505



7506

### Multi-use Targets

Full-color animal faces. Lifelike forest creatures on extra-heavy paper. Circled aiming spots.

- 7501 24" deer two per pack
- 7502 24" target two per pack
- 7503 18" fox three per pack
- 7504 16" target four per pack
- 7505 12" pheasant four per pack
- 7506 12" bobcat four per pack

### Full-color Official FITA NFAA Faces.

- Square:
- 7451 40 cm.
- 7452 60 cm.
- 7453 80 cm.
- 7455 122 cm.
- Skirted round:
- 3660 60 cm.
- 3665 80 cm.
- 3675 122 cm.

### 7436 Indoor PAA and AIAA Official Face

Twenty-inch blue with white bull. Score lines out of sight at line.

### Circular Black and White Target on tag:

- 7401 6" 7404 18"
- 7403 12" 7405 24"

### 7520 Nylon Mesh Backstop

Stops arrows from popular weight bows. Ideal for clubs, schools, indoors, out. Order by square foot, 9' wide by desired length.

### New! Fun Face Target Sets

These exciting new targets add a new dimension to archery fun and skill.



7490 English Darts Target and Alphabet Game Target. One of each per pack.



7491 Baseball Target and Tic Tac Toe Target. One of each per pack.

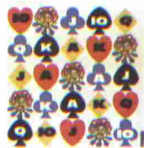

7492 Poker Target and Twenty One Target. One of each per pack.

## Books—Films

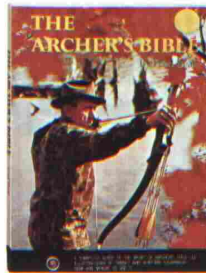

### Recommended Reading

7825

**The Archer's Bible**, by Fred Bear is Fred Bear's complete guide to archery. Covers fundamentals; improving your shot; targetry; small and big game bowhunting; bowfishing; care and safety of equipment; 150 illustrations, including photos of Pope & Young award-winning trophies. For the tyro and pro archer alike. For yourself. As a gift.

### 7810 Bow & Arrow Big Game

**Hunting in Wisconsin** by Otis Bersing. Fascinating reading for hunters around the country. Contains every imaginable statistic on bowhunting in Wisconsin.

### 7811 Archery Champions—2nd

Edition. Covers sport from 1930 to 1962. Gives the scores and biographies of the champions with photos.

### 7812 Archery Champions—4th

Edition. Covers sport from 1963 to 1971.

7813 **The Basic Technique of Instinctive Field Shooting**, published by NFAA

7815 **NAA (and FITA) Official Rule Book**

7817 **Archery Instructor's Guide**

7818 **Power Archery**

7819 "Let's Raise Our Score," Dick Young

7821

**Archer's Digest**, edited by Jack Lewis, editor of Bow & Arrow Magazine. This is the encyclopedia for all archers. More than 300 pages of illustrations and informative tips. Just the thing for beginners or pros.

### Archery Films in Color and Sound

You don't have to be your group's program chairman to recommend these rare and exclusive sound color films. Suggest them for showing at:

- sport and conservation clubs • archery clubs • service clubs • lodges • church groups • Scouts • camps • schools • Y-Indian Guides • banquets

The average running time of these 16mm films is 15 minutes. Rental fee: \$5.00 each 15 minute film \$10.00 for longer films. Send check or money order with reservation to: Grayling Film Service, RR 1, Grayling, Mich. 49738.

### Titles Available:

**Archery . . . Right On!** A new film produced this year giving the newcomer to archery a brief look at all phases of the sport including a few of the basics of shooting. A good introductory film.

**Rural Route One, Grayling, Michigan.** Another NEW film showing how our handcraftsmen make Bear bows and arrows. Narrated by Fred Bear.

**Kaibab Bucks** First bowhunt season in Arizona's Kaibab Forest.

**Trophy Elk** Bowhunting the Royal elk in the Wyoming Rockies.

\***Backcountry Bowhunt** North American big game bowhunt.

**Prairie Pronghorn** An antelope hunt on the Western plains.

**Badland Bucks** North Dakota mule deer hunt.

\***North to Adventure** Record Stone sheep hunt in Canada.

**Bowhunter's Safari** Fred Bear hunts in French Equatorial Africa.

**Bowfishing Fun** Archery's off-season sport.

\***The Oldest Game** An exciting white-tail deer hunt.

**B'wana Bowman** In pursuit of the African Congo elephant with bow and arrow.

**Arrow for a Grizzly** Fred Bear meets grizzly bear in the Yukon wilds.

**Grubstake Bowhunt** Stalking Dall sheep in Alaska.

†**ABC-TV's American Sportsman Grizzly Hunt** Features Fred Bear and grizzly bear.

\***Land of the Tiger** Fred Bear in the land of the Bengal tiger, with bow and arrow.

\***Kodiak Country** Hunting the huge Alaskan Kodiak bear.

\***Fins, Feathers, and Fur** Bowfishing for stingray and alligator gar; bowhunting for bobcat and pheasant.

\***Mozambique Game Trails** Big-game bowhunting in East Africa for nyala, impala, greater kudu, waterbuck, bull elephant.

†**ABC-TV's American Sportsman** Fred Bear's successful Polar bear bowhunt. Part two is of mule deer hunt in New Mexico.

\***The Year of the Cape Buffalo** Fred Bear and Wally Johnson team up to go after the world's meanest game.

\***25th World Archery Championship** International archers competing for coveted world's top prize at Valley Forge, Pa.

\***Archery Today** Bowhunting safety and advice for novice and expert.

\* 22 to 25 minutes each. Rental: \$10.00. Write us about films for TV use.

†Cannot be used for TV or for paid audiences.



## Buying Aids

How to buy what equipment and which accessories? Depends upon what aspect of the sport you're interested in. The items recommended here have been selected personally by Fred Bear. It's good advice.

**Arrows:** Your arrow must match your bow weight and draw length. The weight is marked on the bow. It's easy to determine draw length (see page 27). Select the best quality arrow you can afford, such as the Bear Converta-Point; the heads are interchangeable.

**Aluminum:** 1032—field; 1033—blunt

**Fiberglass:** 1092—field; 1093—blunt

1072—field; 1073—blunt

**Cedar:** 1042—field; 1043—blunt

**Quivers:** Most hunters prefer the Cheyenne 3175 for field and hunting practice. Targeteers prefer the 3725 Big Bear back quiver to hold 24 arrows, and it has a roomy zipper pocket. Tournament shooters favor the Tournament belt quiver, 3735, with divider strap and accessory pocket.

**Gloves:** For field shooting, choose the Master (3380) or the Corfam® Pro-glove (3360). For target and tournament, take the Bear twin tab (3330).

**Armguards:** An armguard protects your arm from string slap and keeps your sleeves from deflecting your shot. The popular choice of all archers is the ventilated armguard, 3465. Another favorite is the 3490 Pickering, of brushed aluminum, because it's cool and comfortable. If you like a longer armguard to protect above and below the elbow, consider the Hunting Armguard, 3480.

**Sights:** The best available is the Bear-Jeffery Omni-Bowsight, 6300, for tournament work. The Tournament Handle Sections of the Victor Vikings and the Victor Tartar® bow are factory-drilled to receive this sight. Another good choice is the Bear® Premier sight, 6050. Write our Custom Service Department for installation details on other bows.

**Targets:** See the wide choice to suit your style, on page 43. Framed, some of them make handsome den wall hangings.

**Additional equipment:** These accessories make your archery more fun, safer, easier.

**7733** Nok-Set nocking points.

**7005** Extra arrow nocks; match shaft size and type.

**7021** Bearfast cement.

**7850** Bowstringer for safety and to prevent bow damage.

**7865** Potawatomi bowsquare; locates your correct nocking point and brace height.

### Custom Bow Department

Customize your Bear® bow to your own style. Allow us four to six weeks, and we'll deliver your personal bow that's as unique as you are. See your Bear dealer for advice and assistance. We'll modify your bow any way you like, as long as it doesn't change the basic design. For example:

1. Radial feathered sight window—you get a deeper, more tunable center shot.
2. Custom grip—to match your special grip.
3. Custom tillering—a special balancing of upper and lower limbs for any shooting style.
4. Physical weight balancing—stabilizer and bushings installed to reapportion the mass static weight balance.
5. Berger Button—to dial your shot; arrow plates.
6. Installation of any bowsight in this catalog.
7. Installation of Bear Premier arrow rests (6255 or 6260).
8. Reduction of your present bow's pull weight.

Fred Bear and Owen Jeffery personally supervise all customizing work. For details, see your Bear dealer, or write Department R & D, Bear Archery, RR 1, Grayling, Mich. 49738.

### How to Order a Bear® Bow

See your Bear dealer. Tell him your height, weight, age, what hand you use and that you want your bow for hunting, target, or both. If there is no dealer near you, write us.



Johnny Negonapinee, Ojibway guide, Western Ontario, CANADA 1946.

Passing the time of day with Them Kjar, Game Commissioner, YUKON TERRITORY, 1956.

### How to Tune Your Bow

Two things make you a good archer: your bow and your arrow. Simple, yes, and important, yes. The idea is to match bow and arrow to you. Then you're ready for fun, sport, game.

#### The Bow

Don't select a bow that requires too much pull for you. Everyone has his limits. Pull your bow, hold it for 10 seconds. If you quiver, that may not be your bow. Don't make it too easy for yourself, either—meaning, too light a pull.

#### The Bowstring

To measure proper brace height, measure at right angles to the string from the deepest cut in the handle on the bow's face below arrow shelf.

#### The Arrow

It's easy to select your proper arrow length. Take up your full draw on a special measuring arrow (marked off in inches). Your arrow length stops at that point of the arrow in relation to the front of arrow shelf (illustrated, page 27).

Now match your draw length to your bow weight. For each inch difference in draw length, add or subtract about two pounds of bow weight from the weight marked on your bow (most bows are weighed at 28"). Example: you have a 30" draw. You're shooting with a 36 lb. bow. Your bow weight is actually 40 lbs. Similarly, if yours is a 27" draw, your 36 lb. bow is drawing only 34 lbs.

Now that you know your actual bow weight at draw length, see your Bear dealer and ask to see a top-quality aluminum arrow. Like the Bear-Easton arrow. Select the arrow according to the weight for your sport—indoor, field, hunting.

The spine is the stiffness of the arrow. An improper spine can put your arrow right or left of target.

Your Bear® dealer can provide you with the best arrow because every box of Bear arrows is factory-marked to indicate spine and length. Correct spine and weight determine arrow speed and trajectory.

Your arrow, then, must match your bow weight and actual draw length. Now you have a matched arrow.

Each Bear shaft is accurately weighted, with the proper wall thickness, and correct spine. In high-quality arrows, the tolerances are precise.

The serious tournament shooter uses the 1010 Bear-Easton aluminum arrow. Intermediate and beginners choose the 1150 Bear Falcon or 1060 cedar arrow.

### How to String a Bow Safely

You still see archers using the push-pull or step-through stringing method. Wrong! You can hurt yourself, and you can damage your favorite bow. Instead, the safe and easy way is with the 7850 Three-Bear Bowstringer. Simply stand on the cord after you attach the bowstringer to bow tips. The tips bend as you pull up, ready for easy, safe stringing. You're in good company; this is the bowstringer used by pros. See page 37.

### How to sharpen Bear Razorhead®

Razorhead are sharpened before they leave the factory, but be sure to sharpen yours before you hunt. Instructions are included in the package. Use a mill file (3135) or the file in the 3130 Fred Bear Bowhunter's Kit for best results. File toward the point and at the original bevel. Finish by holding file flat on bevel at 90° to arrow shaft. Take five or six light strokes on both sides of the edge to remove the burr. File a rounded chisel point, not a long, slender point, or the arrow will curl if it hits bone.





### The Bear Guarantee

When you purchase your bow from an authorized Bear dealer, your purchase is protected. Every Bear bow is numbered and the registration card is yours when you buy it. Fill out and mail within 10 days of purchase.

If the registered bow fails within nine months after date of purchase, Bear Archery repairs it at no cost to you, or replaces the bow if unable to repair. The exceptions are misuse, improper handling, or limb damage caused by improper stringing.

After nine months, and up to 18 months after purchase date, repair or replacement will be made for 1/3 of the purchase price.

After 18 months, and up to 36 months following purchase date, repair or replacement will be at 2/3 of the purchase price.

You must return the bow to us for our inspection. Replacement will be made with a bow of the same model and weight, as closely as possible.

To repeat, the guarantee is valid only when the bow is purchased at an authorized Bear dealer. Dealers are not authorized to make adjustments. **REPLACEMENT IS MADE ONLY BY FACTORY CUSTOMER SERVICE DEPARTMENT.**

This warranty is transferable from one owner to another, provided bow is registered at time of purchase by original owner.

The handle sections of the Bear Take-Down bows are so superior that they carry a full replacement or repair warranty for three years, providing the normal requirements of the Bear guarantee are met.

Take-Down limbs carry the same three-year guarantee as on all Bear bows. Limb replacements must be made in pairs, as each pair is a matched set. Single limbs cannot be supplied.



Calling, AuSable Forest, 1944  
YUKON TERRITORY, 1956  
Fred and Indian Guide, Robert Quock, Coldfish Lake, BRITISH COLUMBIA, 1957.

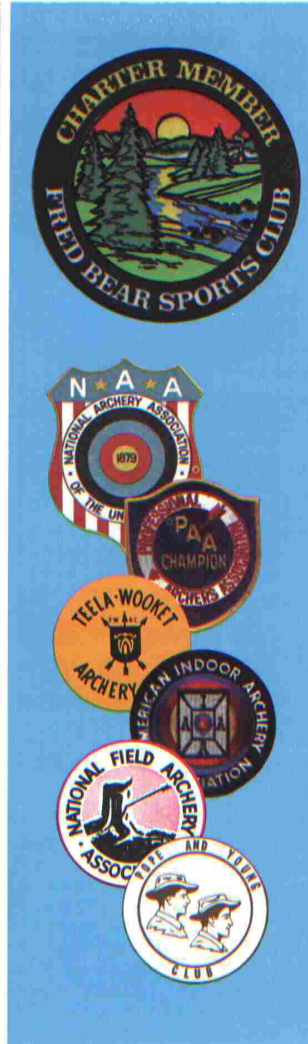

### Organizations

Get more fun out of your shooting. Pick up tips. Go competitive. Join a local archery or bowhunter's club. Or join a national organization that promotes archery. Take your pick:

#### Fred Bear Sports Club

Rural Route One  
Grayling, Michigan 49738

Send for application. Earn Animal Awards, be eligible to shoot the new ALOA/FBSC Indoor Bowhunter Round. And by your support of the Club you will be helping to save the sport of hunting from the Anti-Hunting Groups. Complete information on the following page.

**National Field Archery Association (NFAA)**  
Rte 2, Box 514  
Redlands, Calif. 92373

**National Archery Association (NAA)**  
2833 Lincoln Highway East  
Ronks, Pa. 17572

**American Indoor Archery Association (AIAA)**  
P.O. Box 174  
Grayling, Mich. 49738

**Archery Lane Operators Association (ALOA)**  
729 Frederick Road  
Baltimore, Md. 21228

**Archery Manufacturers Association (AMO)**  
618 Chalmers  
Flint, Mich. 48503

**American Archery Council**  
618 Chalmers  
Flint, Mich. 48503

**Professional Archers Association (PAA)**  
1500 N. Chatsworth St.  
St. Paul, Minn. 55117

**Teela-Wooket Archery Camp**  
Roxbury, Vt. 05669

For more than 30 years, TWAC has been the nation's most complete archery school. For information write: Mrs. Edward B. Miller, 67 (F) Old Stone Church Road, Upper Saddle River, N.J. 07458.

#### The Pope and Young Club

North American Big Game Committee  
P.O. Box 1  
Squaw Valley, California 93646  
Compiles data, keeps records of North American big game taken with bow and arrow in fair chase, conducts biennial competitions, and issues awards.

#### Magazines

Recommended reading for the archer:

#### The Big Sky

% The Fred Bear Sports Club  
Rural Route One  
Grayling, Michigan 49738

The Official Publication of  
The Fred Bear Sports Club.

#### Archery Digest

534 North Broadway  
Milwaukee, Wisc. 53202

#### Archery World

534 North Broadway  
Milwaukee, Wisc. 53202

#### Archery Magazine

(Official publication of NFAA)  
Route 2, Box 514  
Redlands, California 92373

#### Bow and Arrow

130 Olinda Place  
P.O. Box 305  
Brea, Calif. 92621

#### Bowhunter Magazine

9715 King James Court  
Ft. Wayne, Ind. 46804



Sharpening a Razorhead,  
Little Delta, ALASKA 1959.



# If you're not helping to save you are helping to outlaw it!

While just one year old, the Fred Bear Sports Club already has members in all 50 states and 8 foreign countries. State organizations, such as the Alabama Bowhunters, are affiliating with us on the local Chapter level at the suggestion of their state officers and other local Chapter Charters are being set up across the country. The Club is working daily to help save the sport of hunting, and bowhunting in particular, from the anti-hunting groups such as the Friends of Animals, and the Humane Society of the United States. State conservation departments are ordering copies of the Bear Facts cards by the thousands for dissemination to their staff members to help fight the anti-hunters. (see the Bear Facts on the inside mailing cover of this catalog.) We need **your** membership now as well as those of all of the outdoorsmen and outdoorswomen you know to help us in this fight.

## Fred Bear Sports Club Objectives

The Fred Bear Sports Club has as its goals those of saving the sport of hunting from being outlawed, the protection of our outdoor ecology and the proper wildlife management of the woods, fields and waters of this great land. The members are pledged to uphold the Rules of Fair Chase, the state fish and game laws to which they are bound, the preservation of our natural resources and the honest fulfillment of the restrictions under which they compete in all outdoor sports.

## "The Fred Bear Sports Club" Creed

We believe that man has a right to use our natural resources, but that he has a duty to use them wisely, carefully and with reverence.

We believe that wildlife of all sorts must be intelligently managed in a natural environment, and we will work to make it happen.

We believe that clean, pure water is essential to the well-being of all creatures, and we will not pollute it.

We believe that clean air is vital to the survival of all and we will constantly be alert to those who would have it otherwise.

We believe that litter and waste are spoiling our heritage and we will not tolerate it.

We dedicate ourselves to those goals for our own generation and for the generations to come. For we believe this to be the fulfillment of the American Dream.

## Charter Member's Kit

As a Charter Member of The Fred Bear Sports Club you will have the right to compete for and to wear these attractive patches. Only members of The Fred Bear Sports Club will have this right. When accepted for membership you will receive the Charter Member's patch *at no additional charge* along with the Charter Membership items shown (Membership Patch, Bowcase Decal, Bow Decal, Certificate, Credentials and a one year subscription to The Big Sky), the initial Award Patch in each game category (i.e., your first deer) is *free of charge*. Additional copies of this patch may be obtained at \$1.50 each, by members only, check or money order made out to Fred Bear Sports Club. Additional copies of the repeat award chevrons may be obtained at \$.75 each.

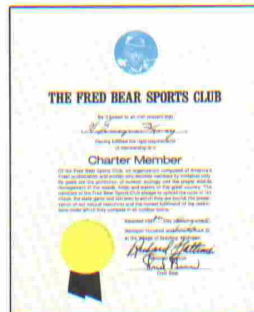

## Member's Certificate

As a Charter Member you will also receive this attractive Certificate suitable for framing for your home, office, or shop.



## Charter Member's Patch

As a Charter Member you will receive this unique Dimension Weld 7 color patch when approved for membership. Additional copies are \$1.50 each.

## Car/Window Decal

A beautiful full color reproduction of the membership patch suitable for use on your automobile window identifying you as a Charter Member can also be yours. Members receive one copy, additional copies are available for 75¢ each.

## Bow Decal

You will also receive a smaller version of the colorful member's seal for use on your bow or other archery equipment. Additional copies are available to registered Charter Members for 25¢ each.





# hunting

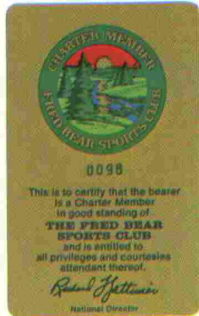

## Membership Card

Your Membership Credential made of durable lifetime plastic will carry your individual Charter Member's Registration number.



## The Big Sky

Members also receive a one year's subscription to The Big Sky, Official Publication of The Fred Bear Sports Club, featuring news of national, state and local anti-hunting activity and alerting Club members to things that would adversely affect our wildlife, ecological balance and natural resources.

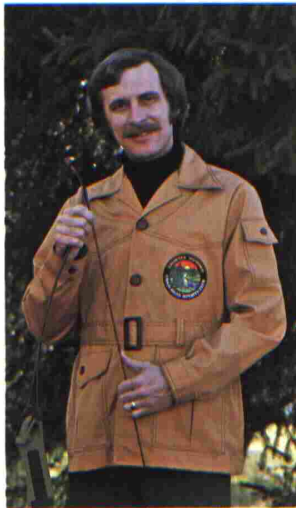

## 8704 Fred Bear Sports Club Jacket

This attractive jacket was designed exclusively for the members of the Fred Bear Sports Club and is available only by ordering direct from Grayling. \$15.00 to members only. Michigan residents add 4% sales tax.

It is tailored of high-quality permanent press material. Available in sizes Extra Large, Large, Medium, Small, Extra Small for the guys. Ladies note: The Extra Small through Medium are designed to fit the Small through Large for the gals. When ordering be sure to specify size, print your name and address and include your Fred Bear Sports Club Charter Membership Number. Enclose check or money order for \$15.00 made out to The Fred Bear Sports Club. We pay postage. Mail to: Jacket, Fred Bear Sports Club, Rural Route One, Grayling, Michigan 49738.



## 8703 Fred Bear Sports Club Zippo Lighter.

Members only. \$4.95 plus 50¢ postage. Available only by ordering direct to The Fred Bear Sports Club, Rural Route One, Grayling, Michigan 49738. You must include your Charter Membership Number when ordering. Enclose check or money order in the amount of \$5.45 made out to The Fred Bear Sports Club. Michigan residents add 4% sales tax.

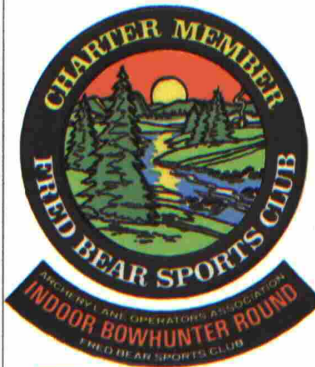

When you join the Fred Bear Sports Club you are eligible to earn the first award free in each award category for not only the Bowhunting awards shown in the next column but also the awards shown above for the new ALO (Archery Lane Operators Association) Fred Bear Sports Club Indoor Bowhunter Round. The Round may be shot only at an official ALO Lanes. For the name and address of the ALO Lanes nearest you, write to Sam Fudenberg, ALO Executive Secretary, 1500 North Chatsworth St., St. Paul, Minn. 55117, area code 612-488-9888. Archery lanes interested in finding out about ALO affiliation may also contact Mr. Fudenberg.

## How you can join the Fred Bear Sports Club

Pick up an application at any Bear Archery dealer's store or if you live in a remote area, you may write for one to: Membership Review Committee, The Fred Bear Sports Club, Grayling, Michigan 49738. The initial membership fee is \$5 with a renewal of \$2 per year thereafter or a renewal of \$5 for three years.



Elk Award (Yellowstone, Roosevelt)



Wild Boar Award (Wild Boar, Javelina, Collared Peccary)



Deer Award (Whitetail, Mule, Columbian, Blacktail, Coues Deer)



Moose Award (Wyoming, Canada, Alaska)



Bear Award (Black, Grizzly, Alaskan Brown)



Antelope Award



Ram Award (Dall, Stone, Desert, Bighorn, Rocky Mountain Goat)



## You May Already Have Earned One or More of These Animal Award Patches

Registered Charter Members of The Fred Bear Sports Club, in good standing, are eligible to win awards in the Bowhunting Division of the Club for game taken under the Rules of Fair Chase during the hunting seasons beginning January 1, 1967 up to and including the current season if taken legally under the laws of the state or territory in which they were hunted. The Award Applications are available at your Bear Archery dealer and must be certified by him before you submit it to the Award Approval Committee in Grayling. The first award patch you earn in each category (i.e., your first deer, your first bear, etc.) is FREE. Additional copies of that particular award are available for \$1.50 each. Additional chevron patches for game taken in each class are \$.75.





**BEAR ARCHERY**

DIVISION  VICTOR COMPTOMETER CORPORATION

Bear Archery, Rural Route One, Grayling, Michigan 49738  
Phone (517) 348-6011

Canadian Bear Archery Distributors  
703 Lebeau Blvd.  
St. Laurent, Montreal 379, Quebec  
Phone 514-331-2510

World Export: Pan Pacific Company  
913 Mission St.  
San Francisco, California 94105  
Phone (415) 433-4741

We reserve the right  
to change specifications  
without notice.

Member Archery  
Manufacturers Organization

**AMO**

Please see your local authorized Bear dealer for  
fair and competitive prices on items offered in this catalog.  
© Bear Archery, 1974 Printed in U.S.A.

*Jotting down notes on the day's  
grizzly hunt for his field notes.  
British Columbia, 1963.*