

# Tianli 天立电机

Tianli Electrical Machinery (Ningbo) Co., Ltd

ISO9001

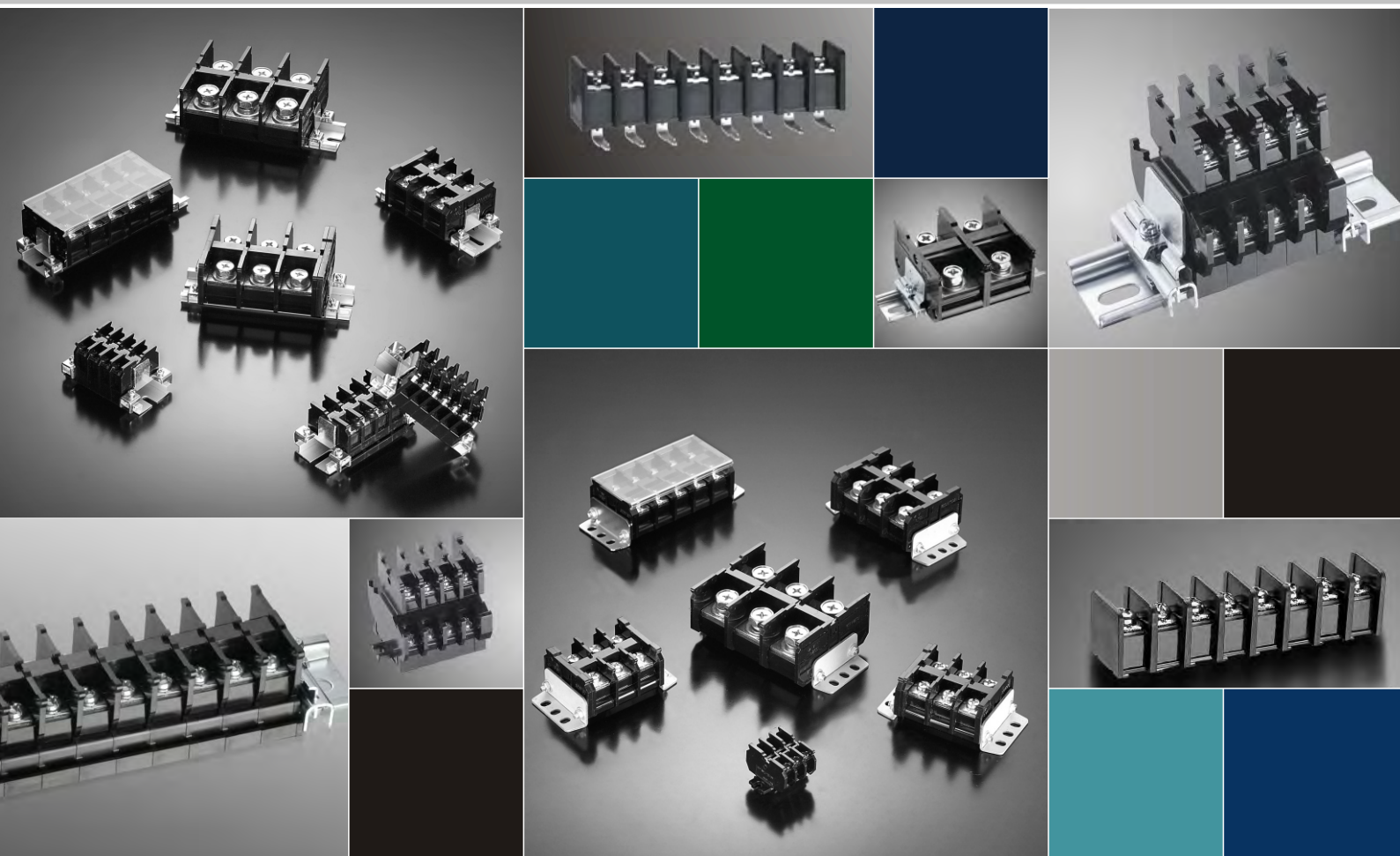



## 企业简介 >>

天立电机（宁波）有限公司是一家接线端子台的专业生产商，本公司生产的端子台用途广泛，适用于防盗器材、电力电气、灯具镇流器、仪器仪表、工业控制及自动化。

公司已通过ISO9001-2008质量体系认证。为了能给客户百分之百的满意，公司对模具开发设备、产品注塑冲压设备、全体员工的技能培训有很大的投入。值得庆幸和自豪的是，我们的努力赢得了国内外客户的信赖，我们的产品通过了UL和VDE认证，产品远销欧美、亚洲各国。天立公司以建成一流企业为宗旨，会一如既往的为客户提供高品质的产品。对客户认真负责，共创繁荣。

## Company profile >>

Tianli Electrical Machinery (Ningbo) Co., Ltd established in 1998 at Cixi City, which specialize in terminal blocks developing and manufacturing. The products are suitable for Security system, Lighting, Automation control, Home appliance and so on, which covered both of electronic and electrical application.

With geographical advantages as it is located at the central region of the Hangzhou Bay Rim economic circle among Shanghai, Hangzhou and Ningbo. All these three cities can access just within one or two hours drive.

The completed processed capability, this is the one of major strength from CAD design, tooling making, injection molding, stamping and assembling all carried out in house.

Regarding the quality management, we granted ISO 9001:2008, and have good will and capable to improving the quality management system continually. All products are certificated by UL, CSA, VDE, CE, CQC, and RoHS and so on. That is reason why our products have been adopted by branded vendors over the world.

Furthermore, we also concerned the lead-time, in order to eliminate your inventory. We work with our valuable customer with forecast in past years, if possible.

Our advantages are not just the best quality and lead time but the most competitive price. We have stable supplier who doing long term cooperation and supplies high quality parts. Meanwhile, Tianli's automation assembly system has been set up and passed the run-in, so that we can offer the competitive price with the high price efficiency to our customers.

03-06

BARRIER SERIES 栅栏式

---

07-12

MODULAR TERMINAL BLOCKS 面板式

---

13-20

RAIL-MOUNTED TERMINAL BLOCKS 导轨式

---

21-22

MODULAR DUAL ROW 双层面板式

---

23-24

RALL-MOUNTEND DUAL ROW 双层导轨式

---

25-26

REFERENCE LIST 配比表

---

27-30

ACCESSORIES FOR MODULAR AND RAIL-MOUNTED SERIES 配件

---

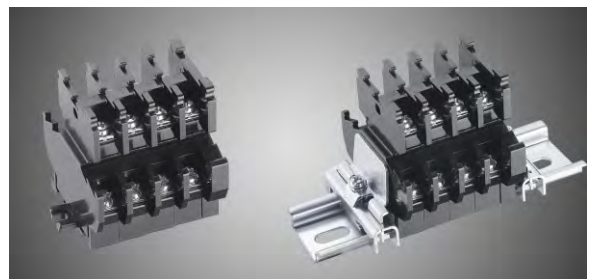
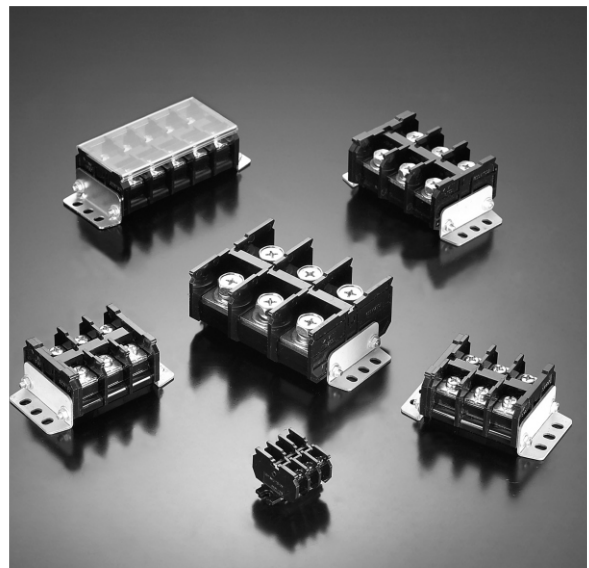
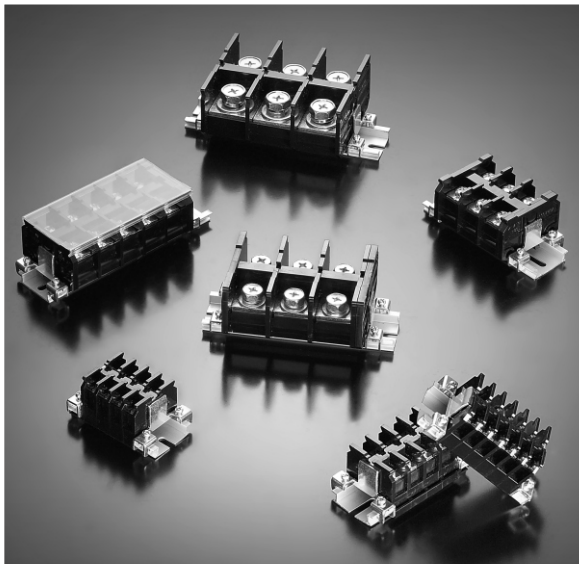
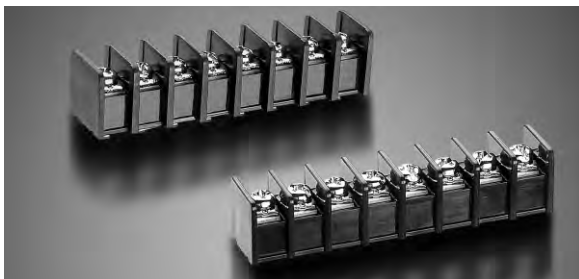

# BARRIER SERIES 栅栏式



如何选型:

HOW TO ORDER:

B/T□□□-□□-□□ PC

- 附盖子, 不写时为无盖子 With Cover, Default: without cover
- 成品P数 Poles
- 规格 Pin Type
- 间距 Pitch : 7.62、8.25、9.50、10.00
- 区分号 Part Number

## B762-01

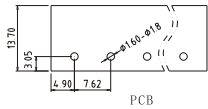
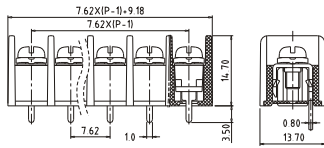

### 技术数据 Technical data

间距	Pitch	7.62
认证	Approval	
电压	Rated voltage	300V 450V
电流	Rated current	15A
线径	Applicable wire	22-14AWG 1.5mm <sup>2</sup>
PCB直径	PCB hole Dia	Φ1.6-1.8mm
螺丝	Screw	M3

### 料号 Part Number

极数(Poles)	型号(Part Number)
02	B762-01-02P
:	:
12	B762-01-12P

## B762-02

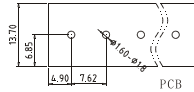
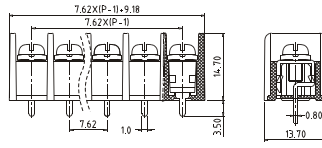

### 技术数据 Technical data

间距	Pitch	7.62
认证	Approval	
电压	Rated voltage	300V 450V
电流	Rated current	15A
线径	Applicable wire	22-14AWG 1.5mm <sup>2</sup>
PCB直径	PCB hole Dia	Φ1.6-1.8mm
螺丝	Screw	M3

### 料号 Part Number

极数(Poles)	型号(Part Number)
02	B762-02-02P
:	:
12	B762-02-12P

## B762-03

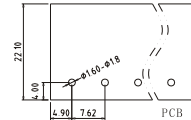
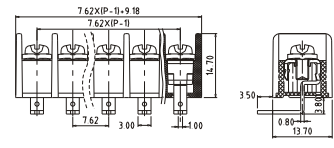

### 技术数据 Technical data

间距	Pitch	7.62
认证	Approval	
电压	Rated voltage	300V 450V
电流	Rated current	15A
线径	Applicable wire	22-14AWG 1.5mm <sup>2</sup>
PCB直径	PCB hole Dia	Φ1.6-1.8mm
螺丝	Screw	M3

### 料号 Part Number

极数(Poles)	型号(Part Number)
02	B762-03-02P
:	:
12	B762-03-12P

## B825-01

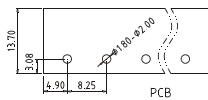
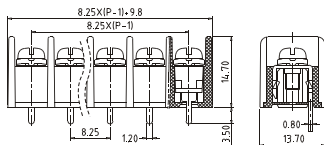

### 技术数据 Technical data

间距	Pitch	8.25
认证	Approval	
电压	Rated voltage	300V 450V
电流	Rated current	20A
线径	Applicable wire	22-12AWG 1.5mm <sup>2</sup>
PCB直径	PCB hole Dia	Φ1.8-2.0mm
螺丝	Screw	M3

### 料号 Part Number

极数(Poles)	型号(Part Number)
02	B825-01-02P
:	:
12	B825-01-12P

## B825-02

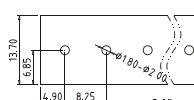
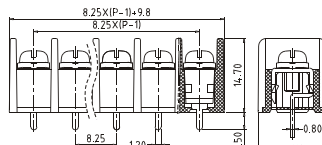

### 技术数据 Technical data

间距	Pitch	8.25
认证	Approval	
电压	Rated voltage	300V 450V
电流	Rated current	20A
线径	Applicable wire	22-12AWG 1.5mm <sup>2</sup>
PCB直径	PCB hole Dia	Φ1.8-2.0mm
螺丝	Screw	M3

### 料号 Part Number

极数(Poles)	型号(Part Number)
02	B825-02-02P
:	:
12	B825-02-12P

## B825-03

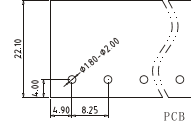
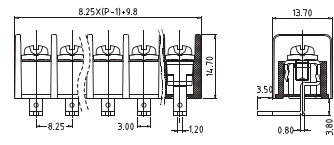

### 技术数据 Technical data

间距	Pitch	8.25
认证	Approval	
电压	Rated voltage	300V 450V
电流	Rated current	20A
线径	Applicable wire	22-12AWG 1.5mm <sup>2</sup>
PCB直径	PCB hole Dia	Φ1.8-2.0mm
螺丝	Screw	M3

### 料号 Part Number

极数(Poles)	型号(Part Number)
02	B825-03-02P
:	:
12	B825-03-12P

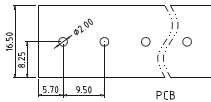
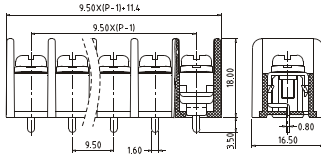
**B950-01**

**技术数据 Technical data**

间距	Pitch	9.50
认证	Approval	
电压	Rated voltage	300V 450V
电流	Rated current	25A
线径	Applicable wire	22-12AWG 2.5mm <sup>2</sup>
PCB直径	PCB hole Dia	Φ2.0mm
螺丝	Screw	M3.5

**料号 Part Number**

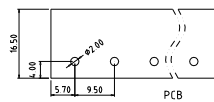
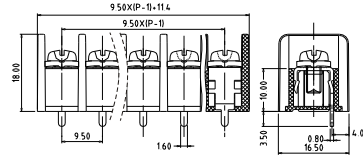
极数(Poles)	型号(Part Number)
02	B950-01-02P
:	:
12	B950-01-12P

**B950-02**

**技术数据 Technical data**

间距	Pitch	9.50
认证	Approval	
电压	Rated voltage	300V 450V
电流	Rated current	25A
线径	Applicable wire	22-12AWG 2.5mm <sup>2</sup>
PCB直径	PCB hole Dia	Φ2.0mm
螺丝	Screw	M3.5

**料号 Part Number**

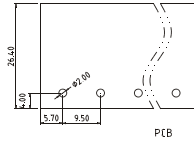
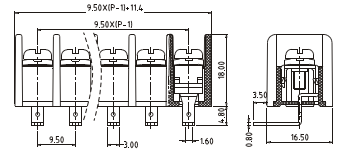
极数(Poles)	型号(Part Number)
02	B950-02-02P
:	:
12	B950-02-12P

**B950-03**

**技术数据 Technical data**

间距	Pitch	9.50
认证	Approval	
电压	Rated voltage	300V 450V
电流	Rated current	25A
线径	Applicable wire	22-12AWG 2.5mm <sup>2</sup>
PCB直径	PCB hole Dia	Φ2.0mm
螺丝	Screw	M3.5

**料号 Part Number**

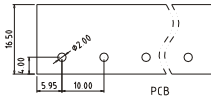
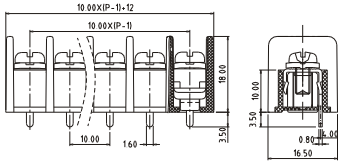
极数(Poles)	型号(Part Number)
02	B950-03-02P
:	:
12	B950-03-12P

**B100-01**

**技术数据 Technical data**

间距	Pitch	10.0
认证	Approval	
电压	Rated voltage	300V 450V
电流	Rated current	25A
线径	Applicable wire	22-12AWG 2.5mm <sup>2</sup>
PCB直径	PCB hole Dia	Φ2.0mm
螺丝	Screw	M3.5

**料号 Part Number**

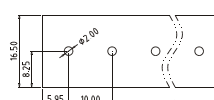
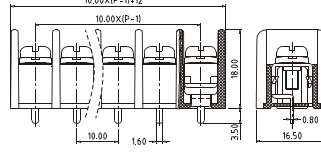
极数(Poles)	型号(Part Number)
02	B100-01-02P
:	:
12	B100-01-12P

**B100-02**

**技术数据 Technical data**

间距	Pitch	10.0
认证	Approval	
电压	Rated voltage	300V 450V
电流	Rated current	25A
线径	Applicable wire	22-12AWG 2.5mm <sup>2</sup>
PCB直径	PCB hole Dia	Φ2.0mm
螺丝	Screw	M3.5

**料号 Part Number**

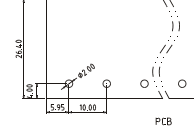
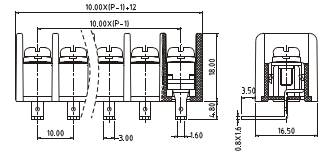
极数(Poles)	型号(Part Number)
02	B100-02-02P
:	:
12	B100-02-12P

**B100-03**

**技术数据 Technical data**

间距	Pitch	10.0
认证	Approval	
电压	Rated voltage	300V 450V
电流	Rated current	25A
线径	Applicable wire	22-12AWG 2.5mm <sup>2</sup>
PCB直径	PCB hole Dia	Φ2.0mm
螺丝	Screw	M3.5

**料号 Part Number**

极数(Poles)	型号(Part Number)
02	B100-03-02P
:	:
12	B100-03-12P

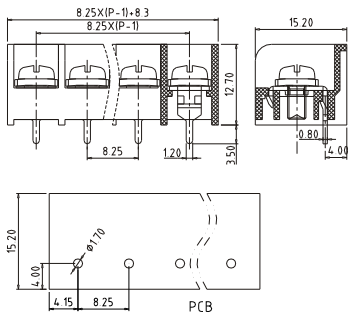
## T825-01



### 技术数据 Technical data

间距	Pitch	8.25
认证	Approval	Applying 
电压	Rated voltage	300V 450V
电流	Rated current	20A
线径	Applicable wire	22-12AWG 1.5mm <sup>2</sup>
PCB直径	PCB hole Dia	Φ 1.7mm
螺丝	Screw	M3.5



### 料号 Part Number

极数(Poles)	型号(Part Number)
02	T825-01-02P
:	:
12	T825-01-12P

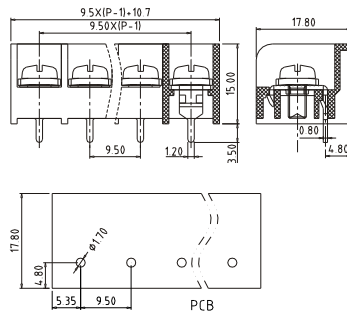
## T950-01



### 技术数据 Technical data

间距	Pitch	9.50
认证	Approval	 
电压	Rated voltage	300V 450V
电流	Rated current	25A
线径	Applicable wire	22-12AWG 2.5mm <sup>2</sup>
PCB直径	PCB hole Dia	Φ 1.7mm
螺丝	Screw	M3.5

### 料号 Part Number

极数(Poles)	型号(Part Number)
02	T950-01-02P
:	:
12	T950-01-12P

# MODULAR TERMINAL BLOCKS 面板式

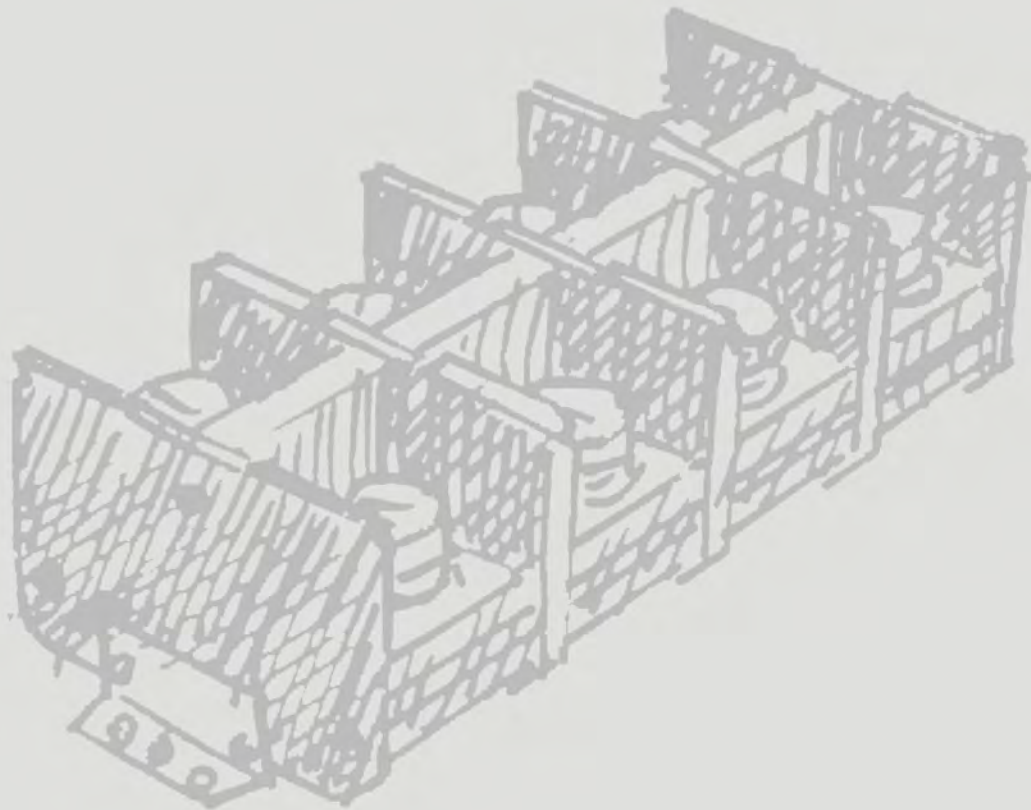

如何选型：

HOW TO ORDER:

TB/TBD□□□CK-□□P

- 成品P数 Poles
- 标示条，不写时为无标示条 With marking label, Default: without marking label
- 附盖子，不写时为无盖子 With Cover, Default: without cover
- 区分号 Part Number



## TBD10-XXP

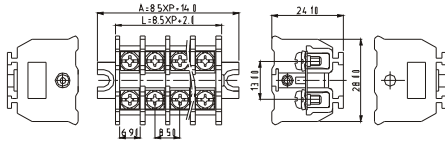

### 技术数据 Technical data

间距	Pitch	8.5mm
认证	Approval	
电压	Rated Voltage	300V
电流	Rated Current	10A
线径	Applicable wire	1.5mm <sup>2</sup>
螺丝	Screw	M3
本体材质	Housing Material	PC

### 料号 Part Number

极数(Poles)	型号(Part Number)
02	TBD10-02P
:	:
12	TBD10-12P

### 尺寸 Size reference

DIM	P	2	3	4	5	6	7	8	9	10	11	12
A		31	39.5	48	56.5	65	73.5	82	90.5	99	107.5	116
L		19	27.5	36	44.5	53	61.5	70	78.5	87	95.5	104

## TBD20-XXP

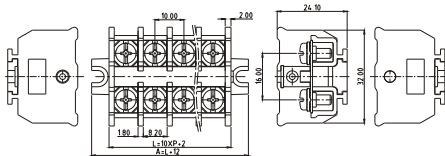

### 技术数据 Technical data

间距	Pitch	10mm
认证	Approval	
电压	Rated Voltage	300V
电流	Rated Current	20A
线径	Applicable wire	2.5mm <sup>2</sup>
螺丝	Screw	M3.5
本体材质	Housing Material	PC

### 料号 Part Number

极数(Poles)	型号(Part Number)
02	TBD20-02P
:	:
12	TBD20-12P

### 尺寸 Size reference

DIM	P	2	3	4	5	6	7	8	9	10	11	12
A		34	44	54	64	74	84	94	104	114	124	134
L		22	32	42	52	62	72	82	92	102	112	122

## TBD10-A

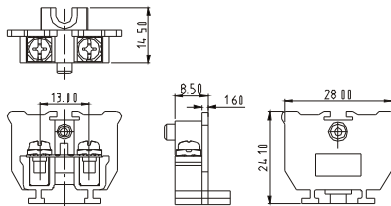

### 技术数据 Technical data

间距	Pitch	8.5mm
认证	Approval	
电压	Rated Voltage	300V
电流	Rated Current	10A
线径	Applicable wire	1.5mm <sup>2</sup>
螺丝	Screw	M3
本体材质	Housing Material	PC

### 料号 Part Number

TBD10-A
---------

单片最小包装：200片/盒  
MPQ: 200PCS/BOX

## TBD20-A

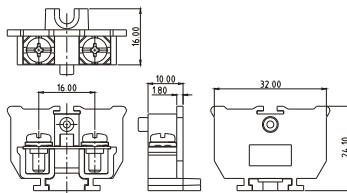

### 技术数据 Technical data

间距	Pitch	10mm
认证	Approval	
电压	Rated Voltage	300V
电流	Rated Current	20A
线径	Applicable wire	2.5mm <sup>2</sup>
螺丝	Screw	M3.5
本体材质	Housing Material	PC

### 料号 Part Number

TBD20-A
---------

单片最小包装：200片/盒  
MPQ: 200PCS/BOX

## TBD10M

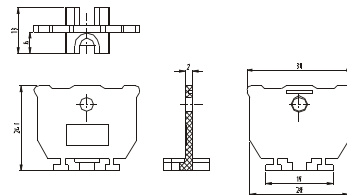

单片最小包装：100片/袋  
MPQ: 100PCS/BAG

## TBD20M

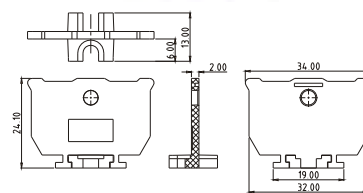

单片最小包装：100片/袋  
MPQ: 100PCS/BAG

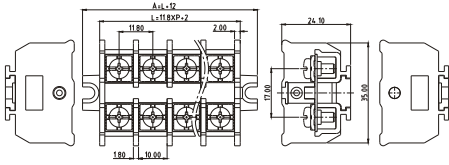
**TBD30-XXP**

**技术数据 Technical data**

间距	Pitch	11.8mm
认证	Approval	
电压	Rated Voltage	300V
电流	Rated Current	30A
线径	Applicable wire	4.0mm <sup>2</sup>
螺丝	Screw	M3.5
本体材质	Housing Material	PC

**料号 Part Number**

极数(Poles)	型号(Part Number)
02	TBD30-02P
:	:
12	TBD30-12P

**尺寸 Size reference**

DIM	P	2	3	4	5	6	7	8	9	10	11	12
A		37.6	49.4	61.2	73	84.8	96.6	108.4	120.2	132	143.8	155.6
L		25.6	37.4	49.2	61	72.8	84.6	96.4	108.2	120	131.8	143.6

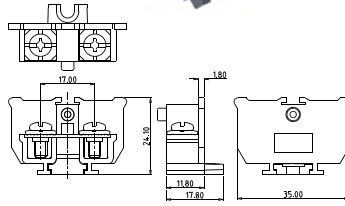
**TBD30-A**

**技术数据 Technical data**

间距	Pitch	11.8mm
认证	Approval	
电压	Rated Voltage	300V
电流	Rated Current	30A
线径	Applicable wire	4.0mm <sup>2</sup>
螺丝	Screw	M3.5
本体材质	Housing Material	PC

**料号 Part Number**

TBD30-A
---------

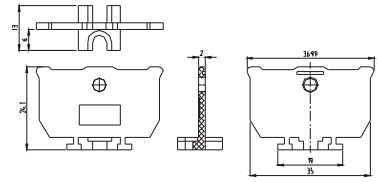
 单片最小包装: 200片/盒  
 MPQ: 200PCS/BOX

**TBD30M**

 单片最小包装: 100片/袋  
 MPQ: 100PCS/BAG

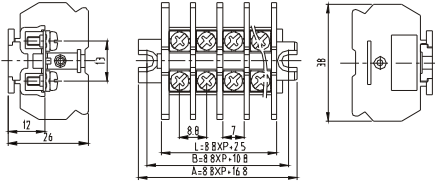
## TB10-XXP



### 技术数据 Technical data

间距	Pitch	8.8mm	
认证	Approval		
电压	Rated Voltage	600V	600V
电流	Rated Current	15A	
线径	Applicable wire	22-14AWG 1.5mm <sup>2</sup>	
螺丝	Screw	M3	
本体材质	Housing Material	PC	

### 料号 Part Number

极数(Poles)	型号(Part Number)
02	TB10-02P
:	:
12	TB10-12P

### 尺寸 Size reference

P	2	3	4	5	6	7	8	9	10	11	12
L	20.1	28.9	37.7	46.5	55.3	64.2	72.9	81.7	90.5	99.3	108.1
A	34.4	43.2	52	60.8	69.6	78.4	87.2	96	104.8	113.6	122.4
B	28.4	37.2	46	54.8	63.6	72.4	81.2	90	98.8	107.6	116.4

## TB20-XXP

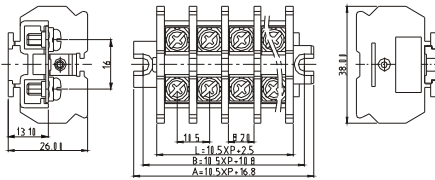

### 技术数据 Technical data

间距	Pitch	10.5mm	
认证	Approval		
电压	Rated Voltage	600V	600V
电流	Rated Current	20A	
线径	Applicable wire	22-12AWG 4.0mm <sup>2</sup>	
螺丝	Screw	M3.5	
本体材质	Housing Material	PC	

### 料号 Part Number

极数(Poles)	型号(Part Number)
02	TB20-02P
:	:
12	TB20-12P

### 尺寸 Size reference

P	2	3	4	5	6	7	8	9	10	11	12
L	23.5	34	44.5	55	65.5	76	86.5	97	107.5	118	128.5
A	37.8	48.3	58.8	69.3	79.8	90.3	100.8	111.3	121.8	132.3	142.8
B	31.8	42.3	52.8	63.3	73.8	84.3	94.8	105.3	115.8	126.3	136.8

## TB10-A

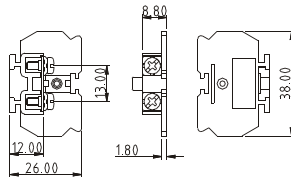

### 技术数据 Technical data

间距	Pitch	8.8mm	
认证	Approval		
电压	Rated Voltage	600V	600V
电流	Rated Current	15A	
线径	Applicable wire	22-14AWG 1.5mm <sup>2</sup>	
螺丝	Screw	M3	
本体材质	Housing Material	PC	

### 料号 Part Number

TB10-A
--------

单片最小包装：100片/袋  
MPQ: 100PCS/BAG

## TB10M

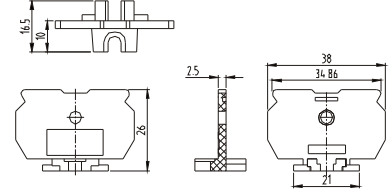

单片最小包装：100片/袋  
MPQ: 100PCS/BAG

## TB20-A

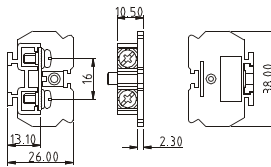

### 技术数据 Technical data

间距	Pitch	10.5mm	
认证	Approval		
电压	Rated Voltage	600V	600V
电流	Rated Current	20A	
线径	Applicable wire	22-12AWG 4.0mm <sup>2</sup>	
螺丝	Screw	M3.5	
本体材质	Housing Material	PC	

### 料号 Part Number

TB20-A
--------

单片最小包装：100片/袋  
MPQ: 100PCS/BAG

## TB20M

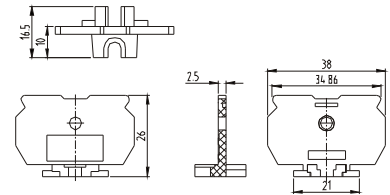

单片最小包装：100片/袋  
MPQ: 100PCS/BAG

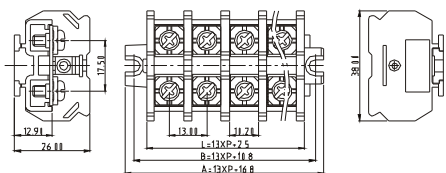
**TB30-XXP**

**技术数据 Technical data**

间距	Pitch	13mm	
认证	Approval		
电压	Rated Voltage	600V	600V
电流	Rated Current	30A	
线径	Applicable wire	22-10AWG 6.0mm <sup>2</sup>	
螺丝	Screw	M4	
本体材质	Housing Material	PC	

**料号 Part Number**

极数(Poles)	型号(Part Number)
02	TB30-02P
:	:
12	TB30-12P

**尺寸 Size reference**

P	2	3	4	5	6	7	8	9	10	11	12
L	28.5	41.5	54.5	67.5	80.5	93.5	106.5	119.5	132.5	145.5	158.5
A	42.8	55.8	68.8	81.8	94.8	107.8	120.8	133.8	146.8	159.8	172.8
B	36.8	49.8	62.8	75.8	88.8	101.8	114.8	127.8	140.8	153.8	166.8

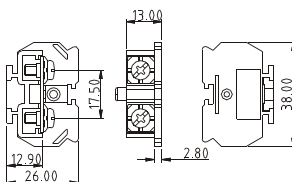
**TB30-A**

**技术数据 Technical data**

间距	Pitch	13mm	
认证	Approval		
电压	Rated Voltage	600V	600V
电流	Rated Current	30A	
线径	Applicable wire	22-10AWG 6.0mm <sup>2</sup>	
螺丝	Screw	M4	
本体材质	Housing Material	PC	

**料号 Part Number**

TB30-A
--------

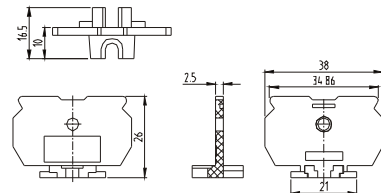
 单片最小包装: 100片/袋  
 MPQ: 100PCS/BAG

**TB30M**

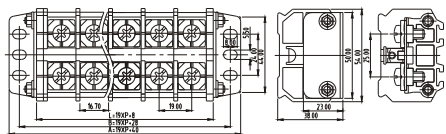
 单片最小包装: 100片/袋  
 MPQ: 100PCS/BAG

**TB60-XXP**

**技术数据 Technical data**

间距	Pitch	19mm	
认证	Approval		
电压	Rated Voltage	600V	600V
电流	Rated Current	65A	
线径	Applicable wire	18-6AWG 16mm <sup>2</sup>	
螺丝	Screw	M6	
本体材质	Housing Material	PC	

**料号 Part Number**

极数(Poles)	型号(Part Number)
02	TB60-02P
:	:
12	TB60-12P

**尺寸 Size reference**

P	2	3	4	5	6	7	8	9	10	11	12
A	78	97	116	135	154	173	192	211	230	249	268
B	66	85	104	123	142	161	180	199	218	237	256
L	46	65	84	103	122	141	160	179	198	217	236

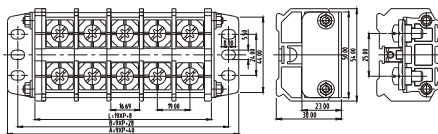
**TB80-XXP**

**技术数据 Technical data**

间距	Pitch	19mm	
认证	Approval		
电压	Rated Voltage	600V	600V
电流	Rated Current	85A	
线径	Applicable wire	18-4AWG 25mm <sup>2</sup>	
螺丝	Screw	M6	
本体材质	Housing Material	PC	

**料号 Part Number**

极数(Poles)	型号(Part Number)
02	TB80-02P
:	:
12	TB80-12P

**尺寸 Size reference**

P	2	3	4	5	6	7	8	9	10	11	12
A	78	97	116	135	154	173	192	211	230	249	268
B	66	85	104	123	142	161	180	199	218	237	256
L	46	65	84	103	122	141	160	179	198	217	236

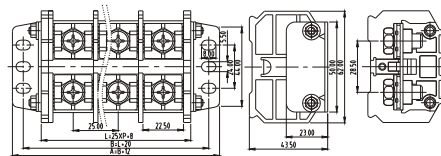
**TB100-XXP**

**技术数据 Technical data**

间距	Pitch	25mm	
认证	Approval		
电压	Rated Voltage	600V	
电流	Rated Current	115/150A	
线径	Applicable wire	8-1/0AWG	
螺丝	Screw	M8	
本体材质	Housing Material	PC	

**料号 Part Number**

极数(Poles)	型号(Part Number)
02	TB100-02P
:	:
12	TB100-12P

**尺寸 Size reference**

P	2	3	4	5	6	7	8	9	10	11	12
A	90	115	140	165	190	215	240	265	290	315	340
B	78	103	125	153	178	203	228	253	278	303	328
L	58	83	108	133	158	183	208	233	258	283	308

## TB150-XXP

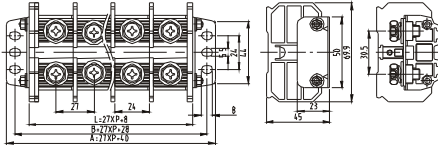

### 技术数据 Technical data

间距	Pitch	27mm
认证	Approval	
电压	Rated Voltage	600V
电流	Rated Current	190A
线径	Applicable wire	8-3/0AWG
螺丝	Screw	M8
本体材质	Housing Material	PC

### 料号 Part Number

极数(Poles)	型号(Part Number)
02	TB150-02P
:	:
12	TB150-12P

### 尺寸 Size reference

P	2	3	4	5	6	7	8	9	10	11	12
A	94	121	148	175	202	229	256	283	310	337	361
B	82	109	139	163	190	217	244	271	298	325	352
L	62	89	116	143	170	197	224	251	278	305	332

## TB200-XXP

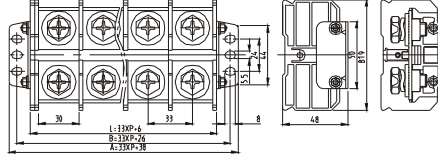

### 技术数据 Technical data

间距	Pitch	27mm
认证	Approval	
电压	Rated Voltage	600V
电流	Rated Current	230A
线径	Applicable wire	8-4/0AWG
螺丝	Screw	M10
本体材质	Housing Material	PC

### 料号 Part Number

极数(Poles)	型号(Part Number)
02	TB200-02P
:	:
12	TB200-12P

### 尺寸 Size reference

DIM	P	2	3	4	5	6	7	8	9	10	11	12
L	72	105	138	171	204	237	270	303	336	369	402	
A	104	137	170	203	236	269	302	335	368	401	434	
B	92	125	158	191	224	257	290	323	356	389	422	

## TB300-XXP

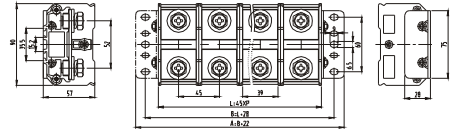

### 技术数据 Technical data

间距	Pitch	45mm
认证	Approval	
电压	Rated Voltage	600V
电流	Rated Current	380A
线径	Applicable wire	3/0-500Kcmil
螺丝	Screw	M10
本体材质	Housing Material	PC

### 料号 Part Number

极数(Poles)	型号(Part Number)
02	TB300-02P
:	:
12	TB300-12P

### 尺寸 Size reference

DIM	P	2	3	4	5	6
A	128	173	218	263	308	
B	112	157	202	247	292	
L	90	135	180	225	270	

## TB500-XXP

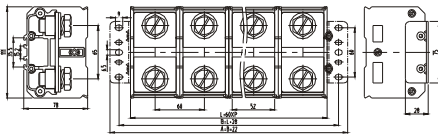

### 技术数据 Technical data

间距	Pitch	60mm
认证	Approval	
电压	Rated Voltage	1000V
电流	Rated Current	475/620A
线径	Applicable wire	750/2 x 250-350Kcmil
螺丝	Screw	M16
本体材质	Housing Material	PC

### 料号 Part Number

极数(Poles)	型号(Part Number)
02	TB500-02P
:	:
12	TB500-12P

### 尺寸 Size reference

DIM	P	2	3	4	5	6
A	170	230	290	350	410	
B	148	208	268	328	388	
L	120	180	240	300	360	

# RAIL-MOUNTED TERMINAL BLOCKS 导轨式

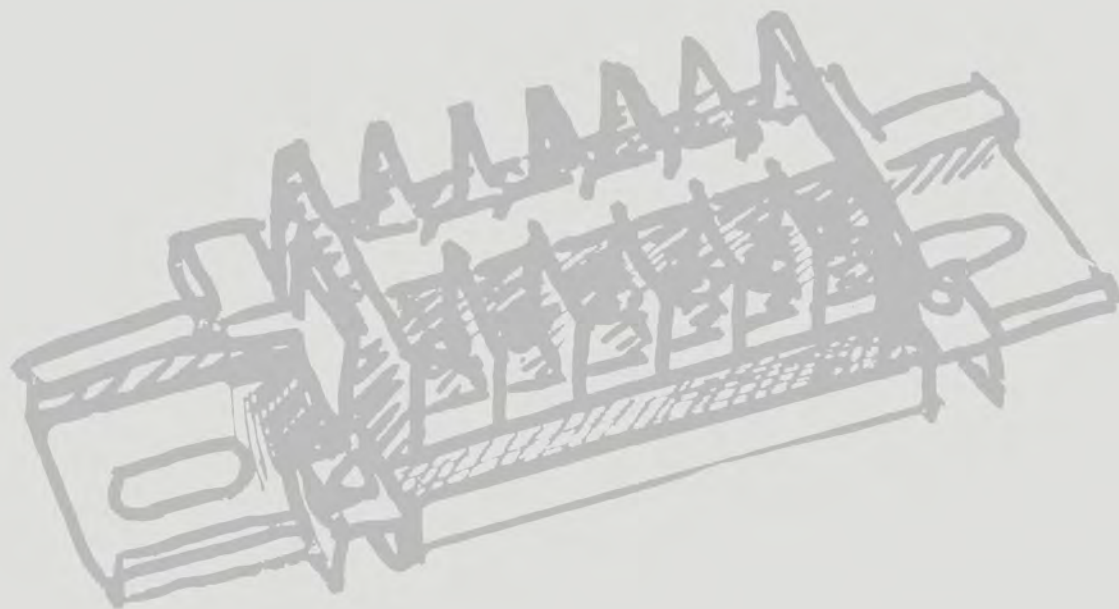

如何选型：

HOW TO ORDER:

TB/TBD□□□DCK-□□P

- 成品P数 Poles
- 标示条，不写时为无标示条 With marking label, Default: without marking label
- 附盖子，不写时为无盖子 With Cover, Default: without cover
- 导轨式 Rail-Mounted
- 区分号 Part Number

## TBD10D-XXP

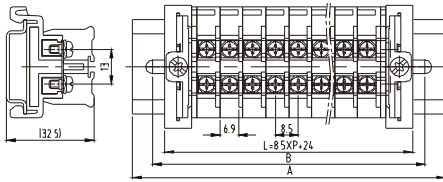

### 技术数据 Technical data

间距	Pitch	8.5mm
认证	Approval	
电压	Rated Voltage	300V
电流	Rated Current	10A
线径	Applicable wire	1.5mm <sup>2</sup>
螺丝	Screw	M3
本体材质	Housing Material	PC

### 料号 Part Number

极数(Poles)	型号(Part Number)
02	TBD10D-02P
:	:
12	TBD10D-12P

### 尺寸 Size reference

DIM	P	2	3	4	5	6	7	8	9	10	11	12
L	41	49.5	58	66.5	75	83.5	92	100.5	109	117.5	126	
A	75	75	100	100	100	125	125	125	150	150	150	
B	59	59	84	84	84	109	109	109	134	134	134	

## TBD20D-XXP

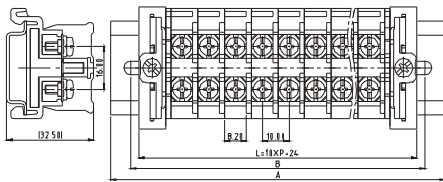

### 技术数据 Technical data

间距	Pitch	10mm
认证	Approval	
电压	Rated Voltage	300V
电流	Rated Current	20A
线径	Applicable wire	2.5mm <sup>2</sup>
螺丝	Screw	M3.5
本体材质	Housing Material	PC

### 料号 Part Number

极数(Poles)	型号(Part Number)
02	TBD20D-02P
:	:
12	TBD20D-12P

### 尺寸 Size reference

DIM	P	2	3	4	5	6	7	8	9	10	11	12
L	44	54	64	74	84	94	104	114	124	134	144	
A	75	100	100	125	125	125	150	150	175	175	175	
B	59	84	84	109	109	109	134	134	159	159	159	

## TBD10

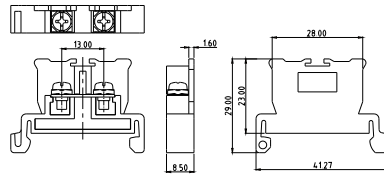

### 技术数据 Technical data

间距	Pitch	8.5mm
认证	Approval	
电压	Rated Voltage	300V
电流	Rated Current	10A
线径	Applicable wire	1.5mm <sup>2</sup>
螺丝	Screw	M3
本体材质	Housing Material	PC

### 料号 Part Number

TBD10
-------

单片最小包装：200片/盒  
MPQ: 200PCS/BOX

## TBD20

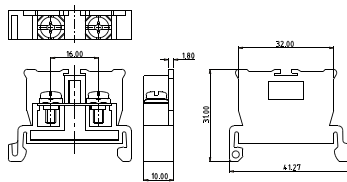

### 技术数据 Technical data

间距	Pitch	10mm
认证	Approval	
电压	Rated Voltage	300V
电流	Rated Current	20A
线径	Applicable wire	2.5mm <sup>2</sup>
螺丝	Screw	M3.5
本体材质	Housing Material	PC

### 料号 Part Number

TBD20
-------

单片最小包装：200片/盒  
MPQ: 200PCS/BOX

## TBD10E

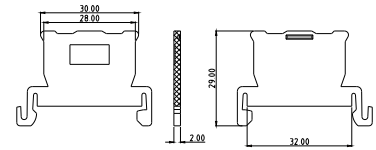

单片最小包装：100片/袋  
MPQ: 100PCS/BAG

## TBD20E

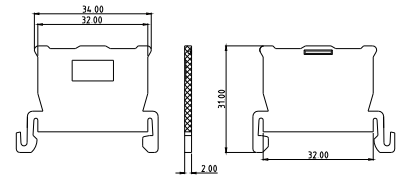

单片最小包装：100片/袋  
MPQ: 100PCS/BAG

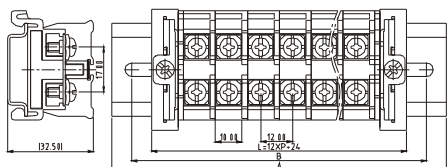
**TBD30D-XXP**

**技术数据 Technical data**

间距	Pitch	12mm
认证	Approval	
电压	Rated Voltage	300V
电流	Rated Current	30A
线径	Applicable wire	4.0mm <sup>2</sup>
螺丝	Screw	M3.5
本体材质	Housing Material	PC

**料号 Part Number**

极数(Poles)	型号(Part Number)
02	TBD30D-02P
:	:
12	TBD30D-12P

**尺寸 Size reference**

DIM	P	2	3	4	5	6	7	8	9	10	11	12
L		48	60	72	84	96	108	120	132	144	156	168
A		100	100	125	125	125	150	150	175	175	200	200
B		84	84	109	109	109	134	134	159	159	184	184

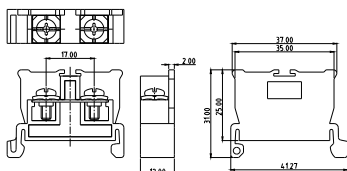
**TBD30**

**技术数据 Technical data**

间距	Pitch	12mm
认证	Approval	
电压	Rated Voltage	300V
电流	Rated Current	30A
线径	Applicable wire	4.0mm <sup>2</sup>
螺丝	Screw	M3.5
本体材质	Housing Material	PC

**料号 Part Number**

TBD30
-------

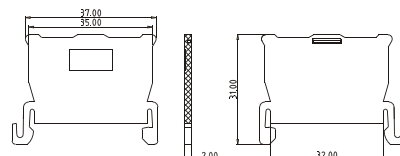
 单片最小包装: 200片/盒  
 MPQ: 200PCS/BOX

**TBD30E**

 单片最小包装: 100片/袋  
 MPQ: 100PCS/BAG

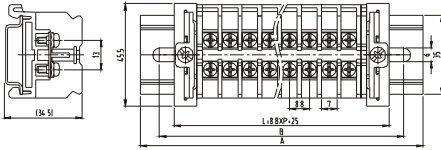

## TB10D-XXP



### 技术数据 Technical data

间距	Pitch	8.8mm	
认证	Approval		
电压	Rated Voltage	600V	600V
电流	Rated Current	15A	
线径	Applicable wire	22-14AWG 1.5mm <sup>2</sup>	
螺丝	Screw	M3	
本体材质	Housing Material	PC	

### 料号 Part Number

极数(Poles)	型号(Part Number)
02	TB10D-02P
:	:
12	TB10D-12P

### 尺寸 Size reference

DIM	P	2	3	4	5	6	7	8	9	10	11	12
L		42.6	51.4	60.2	69	77.8	86.6	95.4	104.2	113	121.8	130
A		75	100	100	125	125	150	150	150	150	175	175
B		59	84	84	84	109	109	134	134	134	159	159

## TB10

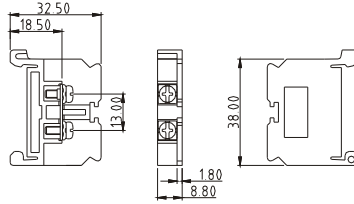

### 技术数据 Technical data

间距	Pitch	8.8mm	
认证	Approval		
电压	Rated Voltage	600V	600V
电流	Rated Current	15A	
线径	Applicable wire	22-14AWG 1.5mm <sup>2</sup>	
螺丝	Screw	M3	
本体材质	Housing Material	PC	

### 料号 Part Number

TB10
------

单片最小包装：270片/盒  
MPQ: 270PCS/BOX

## TB10E

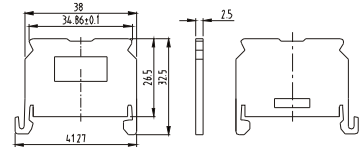

单片最小包装：100片/袋  
MPQ: 100PCS/BAG

## TB20D-XXP

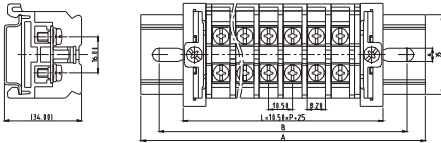

### 技术数据 Technical data

间距	Pitch	10.5mm	
认证	Approval		
电压	Rated Voltage	600V	600V
电流	Rated Current	20A	
线径	Applicable wire	22-12AWG 4.0mm <sup>2</sup>	
螺丝	Screw	M3.5	
本体材质	Housing Material	PC	

### 料号 Part Number

极数(Poles)	型号(Part Number)
02	TB20D-02P
:	:
12	TB20D-12P

### 尺寸 Size reference

DIM	P	2	3	4	5	6	7	8	9	10	11	12
L		46	56.5	67	77.5	88	98.5	109	119.5	130	140.5	151
A		75	100	100	125	125	150	150	150	175	175	200
B		59	84	84	109	109	134	134	134	159	159	184

单片最小包装：220片/盒  
MPQ: 220PCS/BOX

## TB20

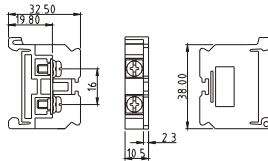

### 技术数据 Technical data

间距	Pitch	10.5mm	
认证	Approval		
电压	Rated Voltage	600V	600V
电流	Rated Current	20A	
线径	Applicable wire	22-12AWG 4.0mm <sup>2</sup>	
螺丝	Screw	M3.5	
本体材质	Housing Material	PC	

### 料号 Part Number

TB20
------

## TB20E

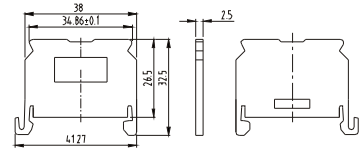

单片最小包装：100片/袋  
MPQ: 100PCS/BAG

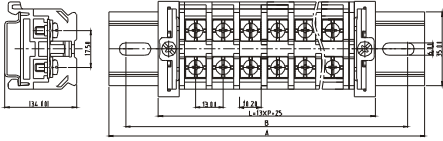
**TB30D-XXP**

**技术数据 Technical data**

间距	Pitch	13mm	
认证	Approval		
电压	Rated Voltage	600V	600V
电流	Rated Current	20A	
线径	Applicable wire	22-10AWG 6.0mm <sup>2</sup>	
螺丝	Screw	M4	
本体材质	Housing Material	PC	

**料号 Part Number**

极数(Poles)	型号(Part Number)
02	TB30D-02P
:	:
12	TB30D-12P

**尺寸 Size reference**

DIM	P	2	3	4	5	6	7	8	9	10	11	12
L		51	64	77	90	103	116	129	142	155	168	181
A		100	100	125	125	150	150	175	175	200	200	225
B		84	84	109	109	134	134	159	159	184	184	209

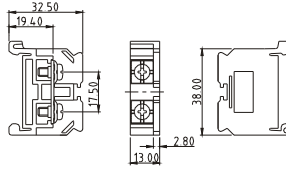
**TB30**

**技术数据 Technical data**

间距	Pitch	13mm	
认证	Approval		
电压	Rated Voltage	600V	600V
电流	Rated Current	20A	
线径	Applicable wire	22-10AWG 6.0mm <sup>2</sup>	
螺丝	Screw	M4	
本体材质	Housing Material	PC	

**料号 Part Number**

TB30
------

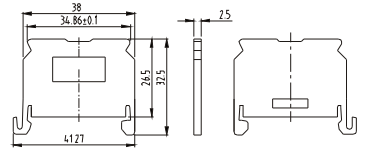
 单片最小包装: 180片/盒  
 MPQ: 180PCS/BOX

**TB30E**

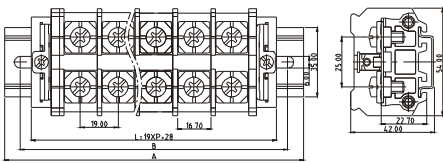
 单片最小包装: 100片/袋  
 MPQ: 100PCS/BAG

**TB60D-XXP**

**技术数据 Technical data**

间距	Pitch	19mm	
认证	Approval		
电压	Rated Voltage	600V	600V
电流	Rated Current	65A	
线径	Applicable wire	18-6AWG 16mm <sup>2</sup>	
螺丝	Screw	M6	
本体材质	Housing Material	PC	

**料号 Part Number**

极数(Poles)	型号(Part Number)
02	TB60D-02P
:	:
12	TB60D-12P

**尺寸 Size reference**

DIM	P	2	3	4	5	6	7	8	9	10	11	12
L		66	85	104	123	142	161	180	199	218	237	256
A		100	125	150	175	175	200	225	250	250	275	300
B		84	109	134	159	159	184	209	234	234	259	284

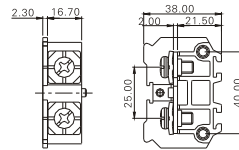
**TB60**

**技术数据 Technical data**

间距	Pitch	19mm	
认证	Approval		
电压	Rated Voltage	600V	600V
电流	Rated Current	65A	
线径	Applicable wire	18-6AWG 16mm <sup>2</sup>	
螺丝	Screw	M6	
本体材质	Housing Material	PC	

**料号 Part Number**

TB60
------

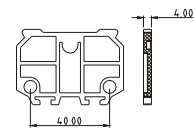
 单片最小包装: 100片/盒  
 MPQ: 100PCS/BOX

**TB60E**

 单片最小包装: 100片/袋  
 MPQ: 100PCS/BAG

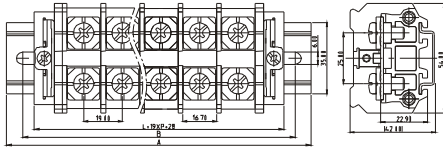
## TB80D-XXP



### 技术数据 Technical data

间距	Pitch	19mm	
认证	Approval		
电压	Rated Voltage	600V	600V
电流	Rated Current	85A	
线径	Applicable wire	18-4AWG	25mm <sup>2</sup>
螺丝	Screw	M6	
本体材质	Housing Material	PC	

### 料号 Part Number

极数(Poles)	型号(Part Number)
02	TB80D-02P
:	:
12	TB80D-12P

### 尺寸 Size reference

DIM	P	2	3	4	5	6	7	8	9	10	11	12
L		66	85	104	123	142	161	180	199	218	237	256
A		100	125	150	175	175	200	225	250	250	275	300
B		84	109	134	159	159	184	209	234	234	259	284

## TB80

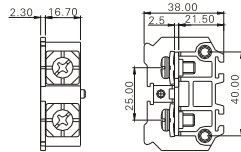

### 技术数据 Technical data

间距	Pitch	19mm	
认证	Approval		
电压	Rated Voltage	600V	600V
电流	Rated Current	85A	
线径	Applicable wire	18-4AWG	25mm <sup>2</sup>
螺丝	Screw	M6	
本体材质	Housing Material	PC	

### 料号 Part Number

TB80
------

单片最小包装: 100片/盒  
MPQ: 100PCS/BOX

## TB80E

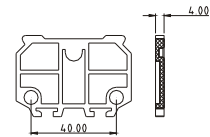

单片最小包装: 100片/袋  
MPQ: 100PCS/BAG

## TB100D-XXP

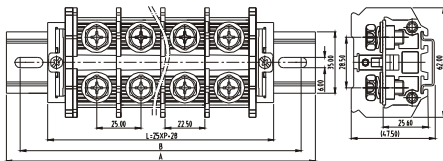

### 技术数据 Technical data

间距	Pitch	25mm
认证	Approval	
电压	Rated Voltage	600V
电流	Rated Current	115/150A
线径	Applicable wire	8-1/0AWG
螺丝	Screw	M8
本体材质	Housing Material	PC

### 料号 Part Number

极数(Poles)	型号(Part Number)
02	TB100D-02P
:	:
12	TB100D-12P

### 尺寸 Size reference

DIM	P	2	3	4	5	6	7	8	9	10	11	12
L		78	103	178	153	178	203	228	253	278	303	328
A		125	150	175	200	225	250	275	300	325	350	378
B		109	134	159	184	209	234	259	284	309	334	359

## TB100

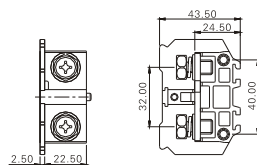

### 技术数据 Technical data

间距	Pitch	25mm
认证	Approval	
电压	Rated Voltage	600V
电流	Rated Current	115/150A
线径	Applicable wire	8-1/0AWG
螺丝	Screw	M8
本体材质	Housing Material	PC

### 料号 Part Number

TB100
-------

单片最小包装: 64片/盒  
MPQ: 64PCS/BOX

## TB100E

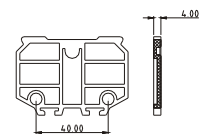

单片最小包装: 50片/袋  
MPQ: 50PCS/BAG

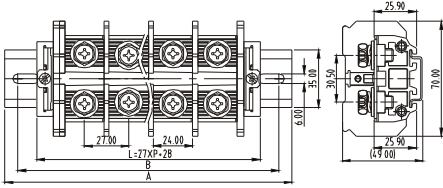
**TB150D-XXP**

**技术数据 Technical data**

间距	Pitch	27mm
认证	Approval	
电压	Rated Voltage	600V
电流	Rated Current	190A
线径	Applicable wire	8-3/0AWG
螺丝	Screw	M8
本体材质	Housing Material	PC

**料号 Part Number**

极数(Poles)	型号(Part Number)
02	TB150D-02P
:	:
12	TB150D-12P

**尺寸 Size reference**

DIM	P	2	3	4	5	6	7	8	9	10	11	12
L	82	109	136	163	190	217	244	271	298	325	352	379
A	125	150	175	200	225	250	275	300	325	350	375	400
B	109	134	159	184	209	234	259	284	309	334	359	384

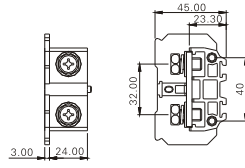
**TB150**

**技术数据 Technical data**

间距	Pitch	27mm
认证	Approval	
电压	Rated Voltage	600V
电流	Rated Current	190A
线径	Applicable wire	8-3/0AWG
螺丝	Screw	M8
本体材质	Housing Material	PC

**料号 Part Number**

TB150
-------

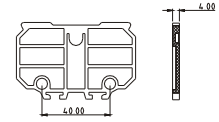
 单片最小包装: 56片/盒  
 MPQ: 56PCS/BOX

**TB150E**

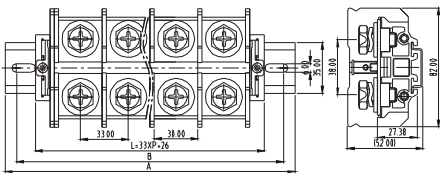
 单片最小包装: 50片/袋  
 MPQ: 50PCS/BAG

**TB200D-XXP**

**技术数据 Technical data**

间距	Pitch	27mm
认证	Approval	
电压	Rated Voltage	600V
电流	Rated Current	230A
线径	Applicable wire	8-4/0AWG
螺丝	Screw	M10
本体材质	Housing Material	PC

**料号 Part Number**

极数(Poles)	型号(Part Number)
02	TB200D-02P
:	:
12	TB200D-12P

**尺寸 Size reference**

DIM	P	2	3	4	5	6	7	8	9	10	11	12
L	92	125	158	191	224	257	290	323	356	389	422	455
A	125	175	200	225	275	300	325	375	400	425	475	500
B	109	159	184	209	259	284	309	359	384	409	459	484

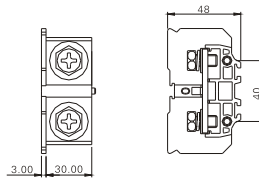
**TB200**

**技术数据 Technical data**

间距	Pitch	27mm
认证	Approval	
电压	Rated Voltage	600V
电流	Rated Current	230A
线径	Applicable wire	8-4/0AWG
螺丝	Screw	M10
本体材质	Housing Material	PC

**料号 Part Number**

TB200
-------

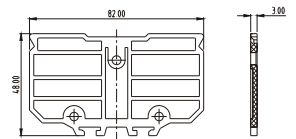
 单片最小包装: 36片/盒  
 MPQ: 36PCS/BOX

**TB200E**

 单片最小包装: 50片/袋  
 MPQ: 50PCS/BAG

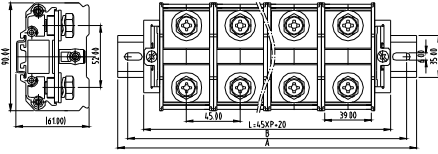
## TB300D-XXP



### 技术数据 Technical data

间距	Pitch	45mm
认证	Approval	
电压	Rated Voltage	600V
电流	Rated Current	380A
线径	Applicable wire	3/0-500Kcmil
螺丝	Screw	M10
本体材质	Housing Material	PC

### 料号 Part Number

极数(Poles)	型号(Part Number)
02	TB300D-02P
:	:
12	TB300D-12P

### 尺寸 Size reference

DIM	P	2	3	4	5	6
L		110	155	200	245	290
A		150	200	250	300	350
B		134	184	234	284	334

## TB300

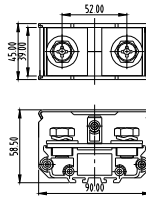

### 技术数据 Technical data

间距	Pitch	45mm
认证	Approval	
电压	Rated Voltage	600V
电流	Rated Current	380A
线径	Applicable wire	3/0-500Kcmil
螺丝	Screw	M10
本体材质	Housing Material	PC

### 料号 Part Number

TB300
-------

单片最小包装：10片/盒  
MPQ: 10PCS/BOX

## TB500D-XXP

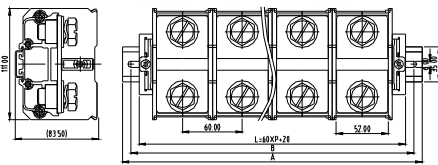

### 技术数据 Technical data

间距	Pitch	60mm
认证	Approval	
电压	Rated Voltage	1000V
电流	Rated Current	475/620A
线径	Applicable wire	750/2 x 250-350Kcmil
螺丝	Screw	M16
本体材质	Housing Material	PC

### 料号 Part Number

极数(Poles)	型号(Part Number)
02	TB500D-02P
:	:
12	TB500D-12P

### 尺寸 Size reference

DIM	P	2	3	4	5	6
L		140	200	260	320	380
A		175	250	300	375	425
B		159	234	284	359	409

## TB500

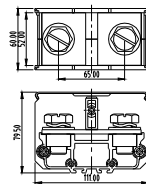

### 技术数据 Technical data

间距	Pitch	60mm
认证	Approval	
电压	Rated Voltage	1000V
电流	Rated Current	475/620A
线径	Applicable wire	750/2 x 250-350Kcmil
螺丝	Screw	M16
本体材质	Housing Material	PC

### 料号 Part Number

TB500
-------

单片最小包装：6片/盒  
MPQ: 6PCS/BOX

# MODULAR DUAL ROW 双层面板式



如何选型：

HOW TO ORDER:

TBR□□CK-□□P

成品P数 Poles

标示条，不写时为无标示条 With marking label, Default: without marking label

附盖子，不写时为无盖子 With Cover, Default: without cover

区分号 Part Number

## TBR10-XXP

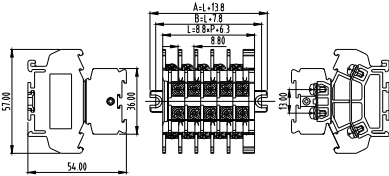

### 技术数据 Technical data

间距	Pitch	7mm
认证	Approval	
电压	Rated Voltage	600V
电流	Rated Current	10A
线径	Applicable wire	22-14AWG
螺丝	Screw	M3
本体材质	Housing Material	PC

### 料号 Part Number

极数(Poles)	型号(Part Number)
02	TBR10-02P
:	:
12	TBR10-12P

### 尺寸 Size reference

P	2	3	4	5	6	7	8	9	10	11	12
L	23.9	32.7	41.5	50.3	59.1	67.9	76.7	85.5	94.3	103.1	111.9
B	31.7	40.5	49.3	58.1	66.9	75.7	84.5	93.3	102.1	110.9	119.7
A	37.7	46.5	55.3	64.1	72.9	81.7	90.5	99.3	108.1	116.9	125.7

## TBR20-XXP

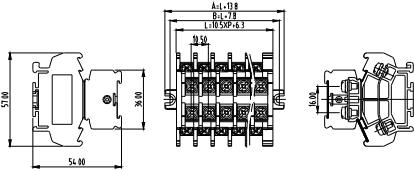

### 技术数据 Technical data

间距	Pitch	8mm
认证	Approval	
电压	Rated Voltage	600V
电流	Rated Current	20A
线径	Applicable wire	22-12AWG
螺丝	Screw	M3.5
本体材质	Housing Material	PC

### 料号 Part Number

极数(Poles)	型号(Part Number)
02	TBR20-02P
:	:
12	TBR20-12P

### 尺寸 Size reference

P	2	3	4	5	6	7	8	9	10	11	12
L	27.3	37.8	48.3	58.8	69.3	79.8	90.3	100.8	111.3	121.8	132.3
B	35.1	45.6	56.1	66.6	77.1	87.6	98.1	108.6	119.1	129.6	140.1
A	41.1	51.6	62.1	72.6	83.1	93.6	104.1	114.6	125.1	135.6	146.1

## TBR10-A

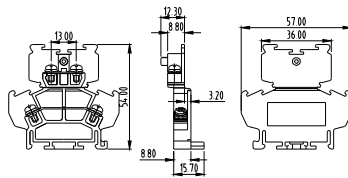

### 技术数据 Technical data

间距	Pitch	7mm
认证	Approval	
电压	Rated Voltage	600V
电流	Rated Current	10A
线径	Applicable wire	22-14AWG
螺丝	Screw	M3
本体材质	Housing Material	PC

### 料号 Part Number

TBR10-A
---------

单片最小包装：100片/盒  
MPQ: 100PCS/BOX

## TBR10M

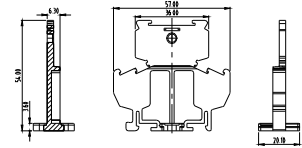

单片最小包装：100片/袋  
MPQ: 100PCS/BAG

## TBR20-A

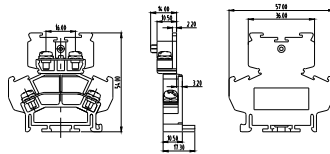

### 技术数据 Technical data

间距	Pitch	8mm
认证	Approval	
电压	Rated Voltage	600V
电流	Rated Current	20A
线径	Applicable wire	22-12AWG
螺丝	Screw	M3.5
本体材质	Housing Material	PC

### 料号 Part Number

TBR20-A
---------

单片最小包装：80片/盒  
MPQ: 80PCS/BOX

## TBR20M

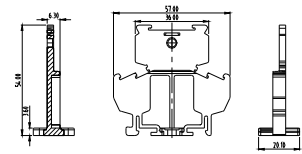

单片最小包装：100片/袋  
MPQ: 100PCS/BAG

# RAIL-MOUNTED DUAL ROW 双层导轨式



如何选型：

HOW TO ORDER:

TBR□□ DCK - □□ P

- 成品P数 Poles
- 标示条，不写时为无标示条 With marking label, Default: without marking label
- 附盖子，不写时为无盖子 With Cover, Default: without cover
- 导轨式 Rail-Mounted
- 区分号 Part Number



## TBR10D-XXP

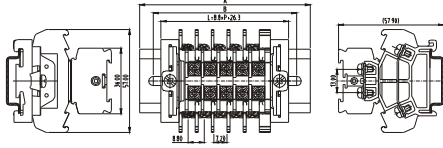

### 技术数据 Technical data

间距	Pitch	7mm
认证	Approval	Applying
电压	Rated Voltage	600V
电流	Rated Current	10A
线径	Applicable wire	22-14AWG
螺丝	Screw	M3
本体材质	Housing Material	PC

### 料号 Part Number

极数(Poles)	型号(Part Number)
02	TBR10D-02P
:	:
12	TBR10D-12P

### 尺寸 Size reference

DIM	P	2	3	4	5	6	7	8	9	10	11	12
L		43.9	52.7	61.5	70.3	79.1	87.9	96.7	105.5	114.3	123.1	131.9
A		59	84	84	84	109	109	109	134	134	134	159
B		75	100	100	100	125	125	125	150	150	150	175

## TBR20D-XXP

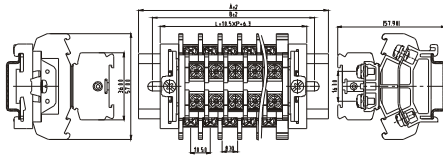

### 技术数据 Technical data

间距	Pitch	8mm
认证	Approval	Applying
电压	Rated Voltage	600V
电流	Rated Current	20A
线径	Applicable wire	22-12AWG
螺丝	Screw	M3.5
本体材质	Housing Material	PC

### 料号 Part Number

极数(Poles)	型号(Part Number)
02	TBR20D-02P
:	:
12	TBR20D-12P

### 尺寸 Size reference

DIM	P	2	3	4	5	6	7	8	9	10	11	12
L		47.3	57.8	68.3	78.8	89.3	99.8	110.3	120.8	131.3	141.8	152.3
A		59	84	84	109	109	134	134	134	159	159	184
B		75	100	100	125	125	150	150	150	175	175	200

## TBR10

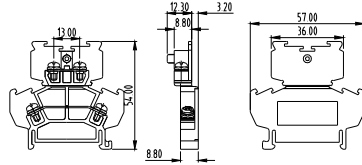

### 技术数据 Technical data

间距	Pitch	7mm
认证	Approval	Applying
电压	Rated Voltage	600V
电流	Rated Current	10A
线径	Applicable wire	22-14AWG
螺丝	Screw	M3
本体材质	Housing Material	PC

### 料号 Part Number

TBR10
-------

单片最小包装: 100片/盒  
MPQ: 100PCS/BOX

## TBR10E

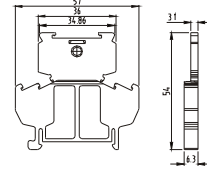

单片最小包装: 100片/袋  
MPQ: 100PCS/BAG

## TBR20

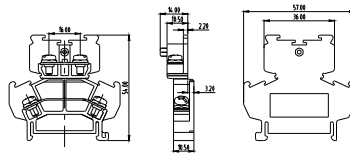

### 技术数据 Technical data

间距	Pitch	8mm
认证	Approval	Applying
电压	Rated Voltage	600V
电流	Rated Current	20A
线径	Applicable wire	22-12AWG
螺丝	Screw	M3.5
本体材质	Housing Material	PC

### 料号 Part Number

TBR20
-------

单片最小包装: 80片/盒  
MPQ: 80PCS/BOX

## TBR20E

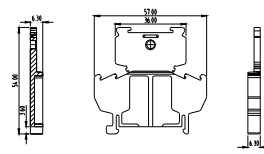

单片最小包装: 100片/袋  
MPQ: 100PCS/BAG

# REFERENCE LIST 配比表



组成 Composition 产品型号 Part NO.	本体 Body	塑胶盖子 Panel	固定片 Holder	导轨 Din-Rail	透明盖 Marking label	标示条 Cover	备注 Remark	
TBD10-XXP	TBD10-A2*1 + TBD10-A*(XX-1)	TBD10M*1					面板式 不含透明盖 不含标示条 Modular terminal blocks Without cover Without marking label	
TBD20-XXP	TBD20-A2*1 + TBD20-A*(XX-1)	TBD20M*1						
TBD30-XXP	TBD30-A2*1 + TBD30-A*(XX-1)	TBD30M*1						
TB10-XXP	TB10-A2*1 + TB10-A*(XX-1)	TB10M*1						
TB20-XXP	TB20-A2*1 + TB20-A*(XX-1)	TB10M*1						
TB30-XXP	TB30-A2*1 + TB30-A*(XX-1)	TB10M*1						
TB60-XXP	TB60*XX	TB60E-A + TB60E-B	TBM60*2					
TB80-XXP	TB80*XX	TB80E-A + TB80E-B	TBM60*2					
TB100-XXP	TB100*XX	TB100E-A + TB100E-B	TBM60*2					
TB150-XXP	TB150*XX	TB150E-A + TB150E-B	TBM60*2					
TB200-XXP	TB200*XX	TB200E-A + TB200E-B	TBM60*2					
TB300-XXP	TB300*XX		TBM300*2					
TB500-XXP	TB500*XX		TBM300*2					
TBD10C-XXP	TBD10-A2*1 + TBD10-A*(XX-1)	TBD10M*1			TBDC10-XXP			面板式 含透明盖 不含标示条 Modular terminal blocks With cover Without marking label
TBD20C-XXP	TBD20-A2*1 + TBD20-A*(XX-1)	TBD20M*1			TBDC20-XXP			
TBD30C-XXP	TBD30-A2*1 + TBD30-A*(XX-1)	TBD30M*1			TBDC30-XXP			
TB10C-XXP	TB10-A2*1 + TB10-A*(XX-1)	TB10M*1			TBC10-XXP			
TB20C-XXP	TB20-A2*1 + TB20-A*(XX-1)	TB10M*1			TBC20-XXP			
TB30C-XXP	TB30-A2*1 + TB30-A*(XX-1)	TB10M*1			TBC30-XXP			
TB60C-XXP	TB60*XX	TB60E-A + TB60E-B	TBM60*2		TBC60-XXP			
TB80C-XXP	TB80*XX	TB80E-A + TB80E-B	TBM60*2		TBC80-XXP			
TB100C-XXP	TB100*XX	TB100E-A + TB100E-B	TBM60*2		TBC100-XXP			
TB150C-XXP	TB150*XX	TB150E-A + TB150E-B	TBM60*2		TBC150-XXP			
TB200C-XXP	TB200*XX	TB200E-A + TB200E-B	TBM60*2		TBC200-XXP			
TB300C-XXP	TB300*XX		TBM300*2		TBC300*XX			
TB500C-XXP	TB500*XX		TBM300*2		TBC500*XX			
TBD10K-XXP	TBD10-A2*1 + TBD10-A*(XX-1)	TBD10M*1				TBDK10-XXP	面板式 不含透明盖 含标示条 Modular terminal blocks Without cover With marking label	
TBD20K-XXP	TBD20-A2*1 + TBD20-A*(XX-1)	TBD20M*1				TBDK20-XXP		
TBD30K-XXP	TBD30-A2*1 + TBD30-A*(XX-1)	TBD30M*1				TBDK30-XXP		
TB10K-XXP	TB10-A2*1 + TB10-A*(XX-1)	TB10M*1				TBK10-XXP		
TB20K-XXP	TB20-A2*1 + TB20-A*(XX-1)	TB10M*1				TBK20-XXP		
TB30K-XXP	TB30-A2*1 + TB30-A*(XX-1)	TB10M*1				TBK30-XXP		
TB60K-XXP	TB60*XX	TB60E-A + TB60E-B	TBM60*2			TBK60-XXP		
TB80K-XXP	TB80*XX	TB80E-A + TB80E-B	TBM60*2			TBK80-XXP		
TB100K-XXP	TB100*XX	TB100E-A + TB100E-B	TBM60*2			TBK100-XXP		
TB150K-XXP	TB150*XX	TB150E-A + TB150E-B	TBM60*2			TBK150-XXP		
TB200K-XXP	TB200*XX	TB200E-A + TB200E-B	TBM60*2			TBK200-XXP		
TB300K-XXP	TB300*XX		TBM300*2			TBK300*XX		
TB500K-XXP	TB500*XX		TBM300*2			TBK500*XX		
TBD10CK-XXP	TBD10-A2*1 + TBD10-A*(XX-1)	TBD10M*1			TBDC10-XXP	TBDK10-XXP		面板式 含透明盖 含标示条 Modular terminal blocks With cover With marking label
TBD20CK-XXP	TBD20-A2*1 + TBD20-A*(XX-1)	TBD20M*1			TBDC20-XXP	TBDK20-XXP		
TBD30CK-XXP	TBD30-A2*1 + TBD30-A*(XX-1)	TBD30M*1			TBDC30-XXP	TBDK30-XXP		
TB10CK-XXP	TB10-A2*1 + TB10-A*(XX-1)	TB10M*1			TBC10-XXP	TBK10-XXP		
TB20CK-XXP	TB20-A2*1 + TB20-A*(XX-1)	TB10M*1			TBC20-XXP	TBK20-XXP		
TB30CK-XXP	TB30-A2*1 + TB30-A*(XX-1)	TB10M*1			TBC30-XXP	TBK30-XXP		
TB60CK-XXP	TB60*XX	TB60E-A + TB60E-B	TBM60*2		TBC60-XXP	TBK60-XXP		
TB80CK-XXP	TB80*XX	TB80E-A + TB80E-B	TBM60*2		TBC80-XXP	TBK80-XXP		
TB100CK-XXP	TB100*XX	TB100E-A + TB100E-B	TBM60*2		TBC100-XXP	TBK100-XXP		
TB150CK-XXP	TB150*XX	TB150E-A + TB150E-B	TBM60*2		TBC150-XXP	TBK150-XXP		
TB200CK-XXP	TB200*XX	TB200E-A + TB200E-B	TBM60*2		TBC200-XXP	TBK200-XXP		
TB300CK-XXP	TB300*XX		TBM300*2		TBC300*XX	TBK300*XX		
TB500CK-XXP	TB500*XX		TBM300*2		TBC500*XX	TBK500*XX		
TBD10D-XXP	TBD10*XX	TBD10E*2	TBT10*2	TS35			导轨式 不含透明盖 不含标示条 Rail-Mounted terminal blocks Without cover Without marking label	
TBD20D-XXP	TBD20*XX	TBD20E*2	TBT10*2	TS35				
TBD30D-XXP	TBD30*XX	TBD30E*2	TBT10*2	TS35				
TB10D-XXP	TB10*XX	TB10E*2	TBT10*2	TS35				
TB20D-XXP	TB20*XX	TB10E*2	TBT10*2	TS35				
TB30D-XXP	TB30*XX	TB10E*2	TBT10*2	TS35				
TB60D-XXP	TB60*XX	TB60E-A*2	TBT60*2	TS35				
TB80D-XXP	TB80*XX	TB80E-A*2	TBT60*2	TS35				
TB100D-XXP	TB100*XX	TB100E-A*2	TBT100*2	TS35				
TB150D-XXP	TB150*XX	TB150E-A*2	TBT100*2	TS35				
TB200D-XXP	TB200*XX	TB200E-A*2	TBT100*2	TS35				
TB300D-XXP	TB300*XX		TBT100*2	TS35				
TB500D-XXP	TB500*XX		TBT100*2	TS35				
TBD10DC-XXP	TBD10*XX	TBD10E*2	TBT10*2	TS35	TBDC10-XXP			导轨式 含透明盖 不含标示条 Rail-Mounted terminal blocks With cover Without marking label
TBD20DC-XXP	TBD20*XX	TBD20E*2	TBT10*2	TS35	TBDC20-XXP			
TBD30DC-XXP	TBD30*XX	TBD30E*2	TBT10*2	TS35	TBDC30-XXP			
TB10DC-XXP	TB10*XX	TB10E*2	TBT10*2	TS35	TBC10-XXP			
TB20DC-XXP	TB20*XX	TB10E*2	TBT10*2	TS35	TBC20-XXP			
TB30DC-XXP	TB30*XX	TB10E*2	TBT10*2	TS35	TBC30-XXP			
TB60DC-XXP	TB60*XX	TB60E-A*2	TBT60*2	TS35	TBC60-XXP			
TB80DC-XXP	TB80*XX	TB80E-A*2	TBT60*2	TS35	TBC80-XXP			
TB100DC-XXP	TB100*XX	TB100E-A*2	TBT100*2	TS35	TBC100-XXP			
TB150DC-XXP	TB150*XX	TB150E-A*2	TBT100*2	TS35	TBC150-XXP			
TB200DC-XXP	TB200*XX	TB200E-A*2	TBT100*2	TS35	TBC200-XXP			
TB300DC-XXP	TB300*XX		TBT100*2	TS35	TBC300*XX			
TB500DC-XXP	TB500*XX		TBT100*2	TS35	TBC500*XX			

组成 Composition 产品型号 Part NO.	本体 Body	塑胶边盖 Panel	固定片 Holder	导轨 Din-Rail	透明盖 Marking label	标示条 Cover	备注 Remark
TBD10DK-XXP	TBD10*XX	TBD10E*2	TBT10*2	TS35		TBDK10-XXP	导轨式 含透明盖 不含标示条 Rail-Mounted terminal blocks With cover Without marking label
TBD20DK-XXP	TBD20*XX	TBD20E*2	TBT10*2	TS35		TBDK20-XXP	
TBD30DK-XXP	TBD30*XX	TBD30E*2	TBT10*2	TS35		TBDK30-XXP	
TB10DK-XXP	TB10*XX	TB10E*2	TBT10*2	TS35		TBK10-XXP	
TB20DK-XXP	TB20*XX	TB10E*2	TBT10*2	TS35		TBK20-XXP	
TB30DK-XXP	TB30*XX	TB10E*2	TBT10*2	TS35		TBK30-XXP	
TB60DK-XXP	TB60*XX	TB60E-A*2	TBT60*2	TS35		TBK60-XXP	
TB80DK-XXP	TB80*XX	TB80E-A*2	TBT60*2	TS35		TBK80-XXP	
TB100DK-XXP	TB100*XX	TB100E-A*2	TBT100*2	TS35		TBK100-XXP	
TB150DK-XXP	TB150*XX	TB150E-A*2	TBT100*2	TS35		TBK150-XXP	
TB200DK-XXP	TB200*XX	TB200E-A*2	TBT100*2	TS35		TBK200-XXP	
TB300DK-XXP	TB300*XX		TBT100*2	TS35		TBK300*XX	
TB500DK-XXP	TB500*XX		TBT100*2	TS35		TBK500*XX	
TBD10DCK-XXP	TBD10*XX	TBD10E*2	TBT10*2	TS35	TBDC10-XXP	TBDK10-XXP	
TBD20DCK-XXP	TBD20*XX	TBD20E*2	TBT10*2	TS35	TBDC20-XXP	TBDK20-XXP	
TBD30DCK-XXP	TBD30*XX	TBD30E*2	TBT10*2	TS35	TBDC30-XXP	TBDK30-XXP	
TB10DCK-XXP	TB10*XX	TB10E*2	TBT10*2	TS35	TBC10-XXP	TBK10-XXP	
TB20DCK-XXP	TB20*XX	TB10E*2	TBT10*2	TS35	TBC20-XXP	TBK20-XXP	
TB30DCK-XXP	TB30*XX	TB10E*2	TBT10*2	TS35	TBC30-XXP	TBK30-XXP	
TB60DCK-XXP	TB60*XX	TB60E-A*2	TBT60*2	TS35	TBC60-XXP	TBK60-XXP	
TB80DCK-XXP	TB80*XX	TB80E-A*2	TBT60*2	TS35	TBC80-XXP	TBK80-XXP	
TB100DCK-XXP	TB100*XX	TB100E-A*2	TBT100*2	TS35	TBC100-XXP	TBK100-XXP	
TB150DCK-XXP	TB150*XX	TB150E-A*2	TBT100*2	TS35	TBC150-XXP	TBK150-XXP	
TB200DCK-XXP	TB200*XX	TB200E-A*2	TBT100*2	TS35	TBC200-XXP	TBK200-XXP	
TB300DCK-XXP	TB300*XX		TBT100*2	TS35	TBC300*XX	TBK300*XX	
TB500DCK-XXP	TB500*XX		TBT100*2	TS35	TBC500*XX	TBK500*XX	
TBR10-XXP	TBR10-A*XX	TBR10M*1					双层面板式 不含透明盖 不含标示条 Modular dual row Without cover Without marking label
TBR20-XXP	TBR20-A*XX	TBR10M*1					
TBR10C-XXP	TBR10-A*XX	TBR10M*1			TBRC10-XXP/TBRCS10-XXP		双层面板式 不含透明盖 不含标示条 Modular dual row With cover Without marking label
TBR20C-XXP	TBR20-A*XX	TBR10M*1			TBRC20-XXP/TBRCS20-XXP		
TBR10K-XXP	TBR10-A*XX	TBR10M*1				TBRK10-XXP	双层面板式 不含透明盖 不含标示条 Modular dual row With cover With marking label
TBR20K-XXP	TBR20-A*XX	TBR10M*1				TBRK20-XXP	
TBR10CK-XXP	TBR10-A*XX	TBR10M*1			TBRC10-XXP/TBRCS10-XXP	TBRK10-XXP	双层面板式 不含透明盖 不含标示条 Modular dual row With cover With marking label
TBR20CK-XXP	TBR20-A*XX	TBR10M*1			TBRC20-XXP/TBRCS20-XXP	TBRK20-XXP	
TBR10D-XXP	TBR10*XX	TBR10E*1	TBT60*2	TS35			双层导轨式 不含透明盖 不含标示条 Rail-Mounted dual row Without cover Without marking label
TBR20D-XXP	TBR20*XX	TBR10E*1	TBT60*2	TS35			
TBR10DC-XXP	TBR10*XX	TBR10E*1	TBT60*2	TS35	TBRC10-XXP/TBRCS10-XXP		双层导轨式 不含透明盖 不含标示条 Rail-Mounted dual row With cover Without marking label
TBR20DC-XXP	TBR20*XX	TBR10E*1	TBT60*2	TS35	TBRC20-XXP/TBRCS20-XXP		
TBR10DK-XXP	TBR10*XX	TBR10E*1	TBT60*2	TS35		TBRKD10-XXP	双层导轨式 不含透明盖 不含标示条 Rail-Mounted dual row With cover With marking label
TBR20DK-XXP	TBR20*XX	TBR10E*1	TBT60*2	TS35		TBRKD20-XXP	
TBR10DCK-XXP	TBR10*XX	TBR10E*1	TBT60*2	TS35	TBRC10-XXP/TBRCS10-XXP	TBRDK10-XXP	双层导轨式 不含透明盖 不含标示条 Rail-Mounted dual row With cover With marking label
TBR20DCK-XXP	TBR20*XX	TBR10E*1	TBT60*2	TS35	TBRC20-XXP/TBRCS20-XXP	TBRDK20-XXP	

范例：TB10CK-5P由TB10-A2\*1片+ TB10-A\*4片+ TB10M\*1片+ TBC10-5P+ TBK10-5P组成

Example: TB10CK-5P is composed of TB10-A2\*1PCS+ TB10-A\*4 PCS+ TB10M\*1 PCS+ TBC10-5P+ TBK10-5P

# ACCESSORIES FOR MODULAR AND RAIL-MOUNTED SERIES 配件

## TS35-01

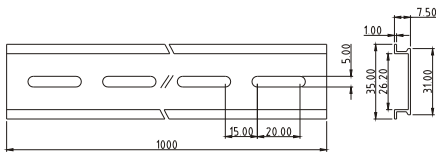

### 技术数据 Technical data

材质	Material	Al
长度	Length	1000mm

### 料号 Part Number

TS35-01

## TS35-02

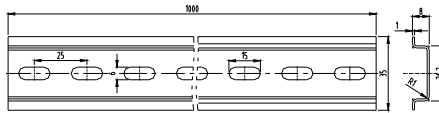

### 技术数据 Technical data

材质	Material	Steel
长度	Length	1000mm

### 料号 Part Number

TS35-02

## TBS1

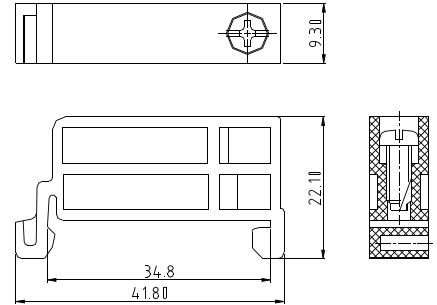
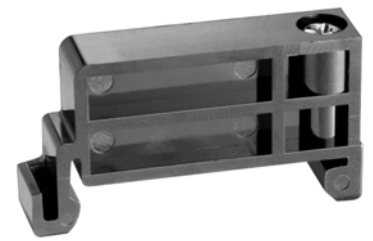

## TBM

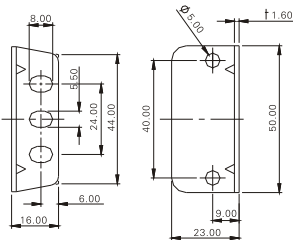

TB60、TB80、TB100、TB150、TB200 共用固定边盖  
COMMON PARTS FOR TB60、TB80、TB100、  
TB150、TB200

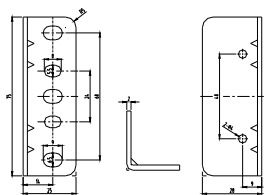

TB300、TB500 共用固定边盖  
COMMON PARTS FOR TB300、TB500

## TBK

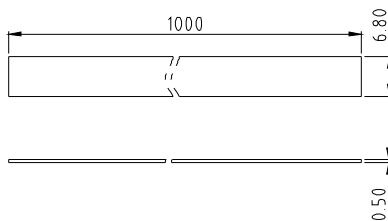
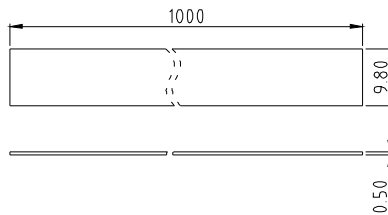



CSTB□□R-□□P

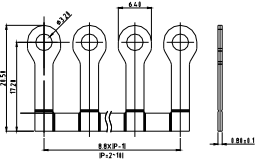

CSTB10R-□□P

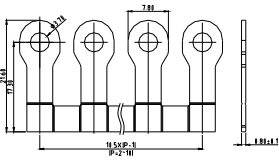

CSTB20R-□□P

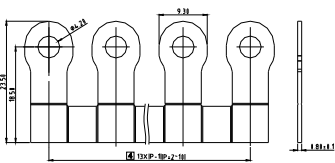

CSTB30R-□□P

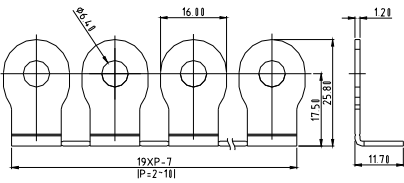

CSTB60R-□□P

CSTB□□Y-□□P

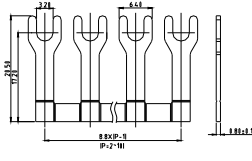

CSTB10Y-□□P

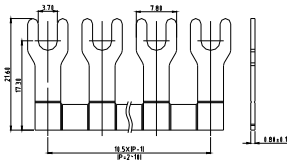

CSTB20Y-□□P

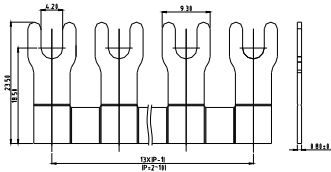

CSTB30Y-□□P

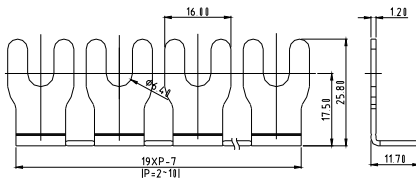

CSTB60Y-□□P

CSTB□□R-□□PC

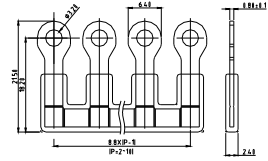

CSTB10R-□□PC

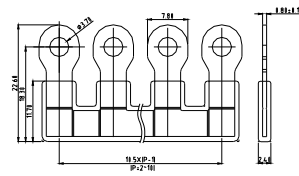

CSTB20R-□□PC

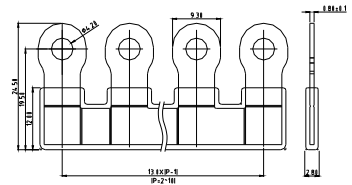

CSTB30R-□□PC

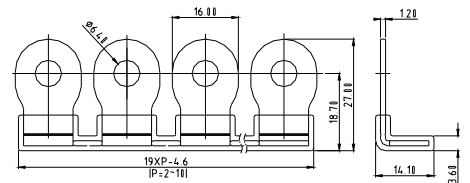

CSTB60R-□□PC

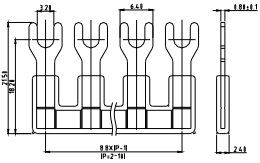
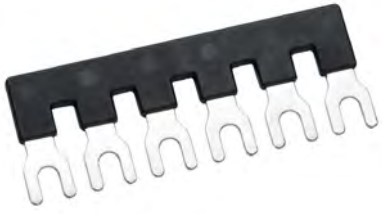

CSTB10Y-□□PC

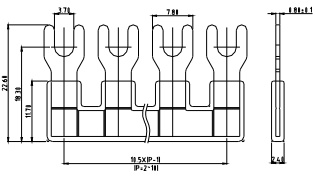

CSTB20Y-□□PC

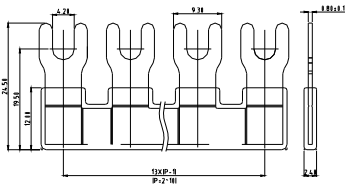

CSTB30Y-□□PC

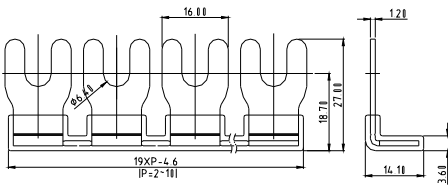

CSTB60Y-□□PC



**Tianli Electrical Machinery (Ningbo) Co., Ltd**

## 天立电机（宁波）有限公司

地址：中国浙江省慈溪市庵东工业园区纬三路138号

邮编：315327

国内销售：

电话：0574-6347-9600, 6347-9618

传真：0574-6389-7084, 6347-9611

Web: [www.china-tianli.com](http://www.china-tianli.com)

## Tianli Electrical Machinery (Ningbo) Co., Ltd.

ADD: 138, Weisan Rd., Andong Development Zone, Cixi,  
Zhejiang, 315327 China

Export Department:

TEL: +86-574-6347-9600, 6389-6436

FAX: +86-574-6389-7084, 6347-9611

Web: [www.china-tianli.com](http://www.china-tianli.com)