



Ratchet P Clamp

Rugged Bundle Management for Heavy Duty Applications



Rugged Bundle Management for Heavy Duty Applications

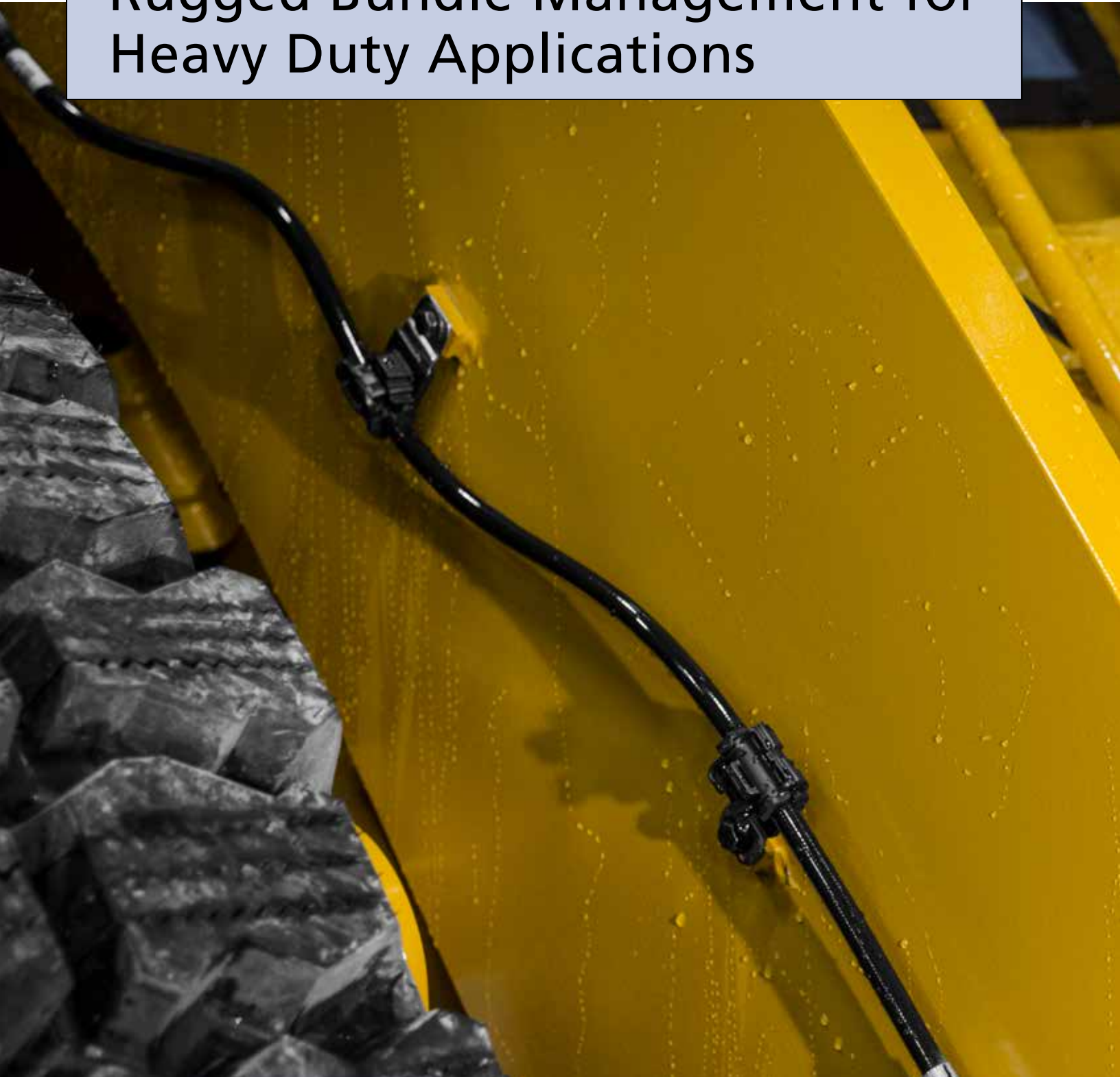

You are always looking to reduce costs and streamline work flows. But to adopt a new component, it also needs to meet your needs for versatility, durability and ease of use – without compromising performance.

The Ratchet P Clamp's patent-pending design makes it extremely versatile for managing wire harnesses and cables. Its rugged construction and specialized materials are perfect for heavy duty applications, indoors and out.

You close the one-piece adjustable clamp manually, exactly to the desired diameter. Audible clicks let you know that it's secured. Releasing the bundle is simple and nondestructive – all you need is a small, flat head screwdriver.

Offered in four sizes and in several mounting configurations, the reusable design minimizes part inventory, speeds fastening and simplifies maintenance. Ratchet P Clamp is available with zinc-plated or stainless steel mounting plates, options that make it ideal even when conditions are extremely harsh or dissimilar metals are used.

Old fashioned P clamps are difficult to position, can twist and pinch wires during installation, and complicate maintenance. They corrode or wear out over time. Plus, you often need to invest in an extensive inventory to have all the sizes and variations you need.

Engineered with both the application and the user in mind, Ratchet P Clamp offers:

- Versatility – Secure hard lines, soft cable bundles ranging from ¼" to 2" wide
- Ease of Use – Position, torque down, close by hand – that's it!
- Alignment – Center cables as the clamp closes
- Durability – PA66 body and coated or stainless steel mounting plates withstand harsh environments in a wide range of applications.

Markets



Versatility

Working with a mix of wires and cable sizes? Need to route multiple bundles in parallel? Ratchet P Clamp will secure a range of cables without changing any other part of your cable routing and management strategy.

Multiple Sizes

Four ratchet sizes accommodate hard line and soft cable bundles ranging from 0.24" (6.2mm) - 2.0" (51mm) in diameter. You can reduce your inventory with only a few adjustable P clamps.



Multiple angle configurations

Mounting Options

From slightly offset to raised off the frame or panel, and with various angles and mounting plate lengths, you can fix cables exactly where design specifications dictate. Each mounting plate option is offered in four angles (180°, 15°, 30° and 90°) and four different mounting hole diameters: M6 (6mm), M8 (8mm), M10 (10mm) and M12 (12mm).

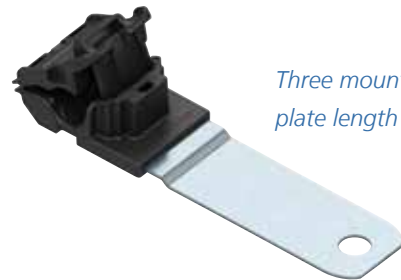

Three mounting plate length options

Multiple Configurations

You can stack and mix Ratchet P Clamps with different mounting plate lengths and angles to manage diverse cable combinations. There is an unlimited number of possible routing options and configurations.

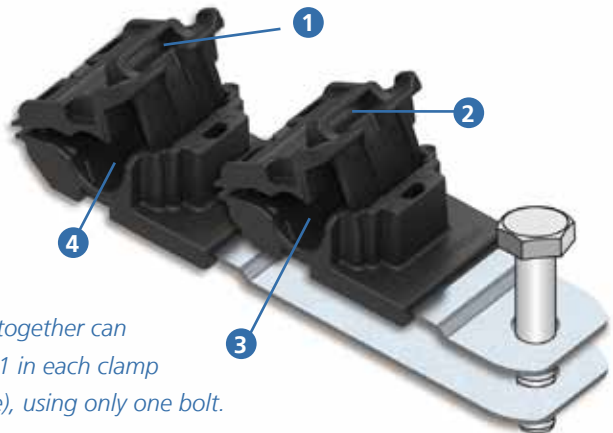

Stacking a short and long length together can give you up to 4 fixing points (1 in each clamp and 1 in each cable tie saddle), using only one bolt.

Ease of Use

No more struggling with grommets and two-piece designs that are difficult to handle. We also eliminated having to pry open the clamp when you need to reposition a bundle or change out the clamp. You can also use our EVO hand tools to secure the ratchet, if that is how you prefer to work.

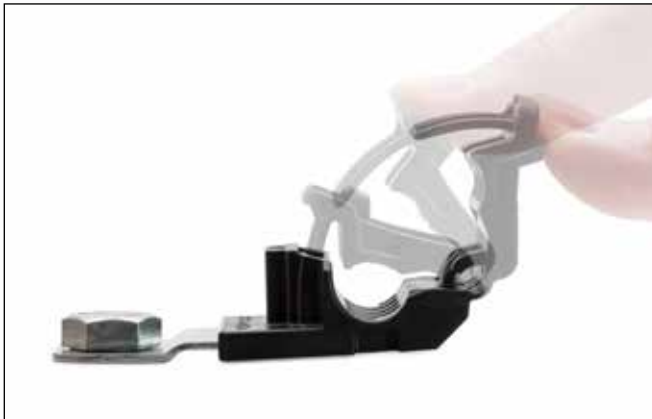

One-Piece Design – One-Touch Secure

Our one-piece, solid body design is operated manually, clicking as it closes to let you know it's secure. You'll also never have to put a clamp in place and struggle to mount it while holding the pieces together around the bundle.



Releasability

Releasability is one of Ratchet P Clamp's unique features. All you need is a small, flat head screwdriver to open the clamp. Simply guide the screwdriver between the ratchet rails and pull away from the bundle. Ratchet P Clamp's non-destructive, releasable clamp streamlines bundle installation and service.

Tension Tab

The Tension Tab is a molded plastic strap engineered specifically for using EVO Series hand tools to close a Ratchet P Clamp. Tension Tabs enable you to fix bundles with precision, at any of 33 preset tension settings.



Optional Tension Tab

Alignment

Because the clamp area is independent from the mounting plate, the design allows for pre-installation on frame rails and pre-assembly on wire harnesses. The advantage? Greater efficiencies that drive productivity and profitability.

Pre-installation/Pre-assembly



During pre-installation, simply install bolts in mounting plates and leave the clamps open. You can then insert the bundle into multiple clamps along the route, in one pass, reducing installation time by getting the alignment right the first time.

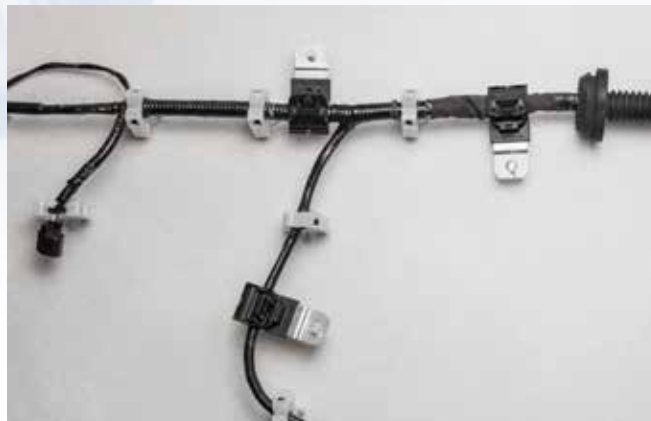

You can also attach Ratchet P Clamps along wire harnesses to pre-assemble the harness before taking the next step. You'll streamline the process and add production line workflow flexibility.



Contoured Clamp Interior

The contoured clamp interior helps to position and center cables or bundles as the clamp closes, minimizing pinching and the associated rework caused by damage to wires.



Cable Tie Saddle

Working with customers on a variety of applications, we learned that electrical runs and other bundles sometimes need to be secured adjacent to side-by-side bundles. That inspired us to add the integrated cable tie saddle for additional routing. Rounded to cradle the bundle, the cable tie saddle enables fixing everything from T18 to wide strap ties.

Durability

Whether you are assembling trucks or automobiles, manufacturing severe duty vehicles or wiring a solar farm, you'll know that the cables will be easy to maintain and functional for years to come. Both zinc-plated and stainless steel mounting plates establish a fixing point that secures wires exactly where they need to be, for the life of the application.

Robust Materials



Impact modified, heat and UV stabilized PA66 material clamp is extremely durable and will not abrade cables and hoses. There's no coating to wear off and the robust living hinge is engineered to far exceed any expected application requirements.



The stamped mounting plate is treated to resist chemicals and has a coating that meets RoHS specifications for environmental factors. The special hardened steel withstands high torque bolt installation. Ratchet P Clamp also comes with a stainless steel mounting plate, so there's no galvanic corrosion with dissimilar metals.

How to Choose a Ratchet P Clamp

STEP 1: Determine bundle diameter.

Match the bundle diameter range to the wire bundles you use.

SIZE	BUNDLE DIAMETER RANGE
A	0.24" - 0.54" (6.2mm - 13.7mm)
B	0.50" - 0.77" (12.7mm - 19.5mm)
C	0.76" - 1.42" (19.4mm - 36.0mm)
D	1.42" - 2.0" (36.0mm - 51.0mm)



STEP 2: Choose routing orientation/variant.

Choose from 180° straight, 15°, 30° or 90° angles.



180° straight



15°



30°

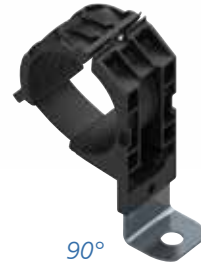

90°

STEP 3: Specify the length of the mounting plate.

We designed the mounting plate specification to be equal to the distance from center of clamp to center of mounting hole. (Some angles/variants are not offered in all three lengths.)



Short



Medium



Long

STEP 4: Choose bolt size/mounting hole diameter.

Each mounting plate option is offered in four different mounting hole diameters to accommodate the most common bolt sizes: M6 (6mm), M8 (8mm), M10 (10mm) and M12 (12mm).



Step 5: Select mounting plate material.

The treated high-grade steel mounting plate is suited for most applications. Opt for the stainless steel mounting plate when conditions are exceptionally severe or galvanic corrosion is possible.

Multiple Configurations

The wiring schemes in heavy duty applications become more complex day after day. Using a single mounting point, you can combine Ratchet P Clamps to match the number, position and diameters of the wires or bundles inherent to today's wire management challenges. You will see below just a few of the nearly endless number of configurations you can arrange by mixing Ratchet P Clamps of varying sizes and different mounting plates.

1

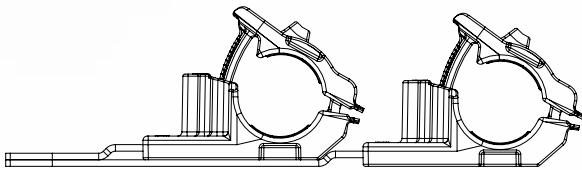

You can piggy-back Ratchet P Clamps by using different length mounting plates to secure parallel cable configurations.

2

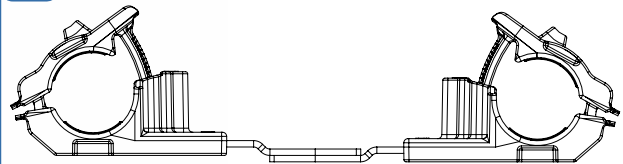

Ratchet P Clamp mounting plates are shaped to allow face-to-face positioning. By using different length mounting plates, you can vary the distance between bundles and take advantage of the optimal routing path.

3

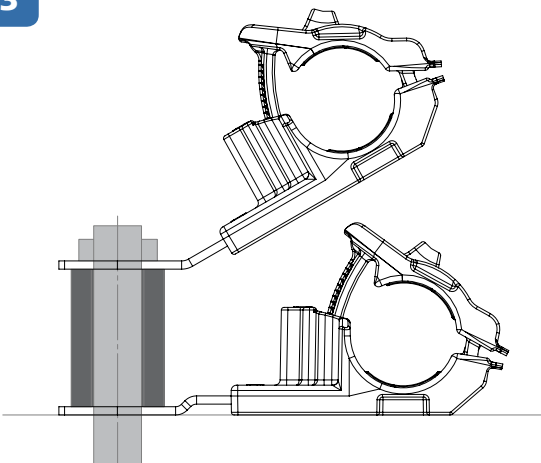

Add a spacer between Ratchet P Clamps to speed installation and maintenance of stacked wire bundles.

4

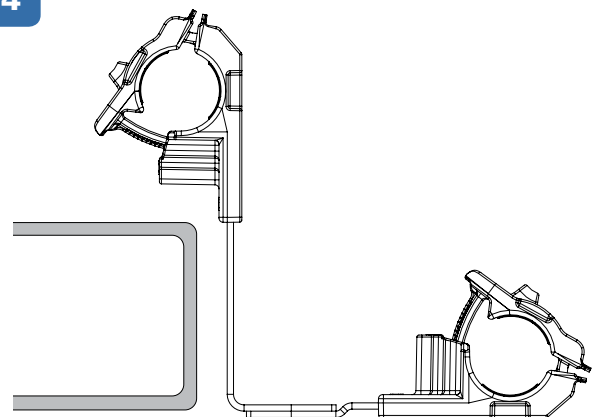

90° angle mounting plates enable you to work around obstacles and protect wire from contacting moving parts.

Features

Integrated cable tie saddle provides a second fixing point.

Impact modified, heat and UV stabilized PA66 plastic ensures long-term durability.

One-piece ratchet closure allows for easy installation, one-touch close.

Screwdriver release enables easy adjustments and maintenance.

Contoured clamp interior is designed to guide and center bundle to reduce pinching.

Tension Tabs slide through this slot to facilitate closure using an EVO Series hand tool.

Interior rib design minimizes movement due to vibration.

Mounting plates are available with M6, M8, M10 and M12 diameter hole sizes.

Treated or stainless steel mounting plates tolerate high-torque mounting, resist chemicals and salt spray, and do not corrode.

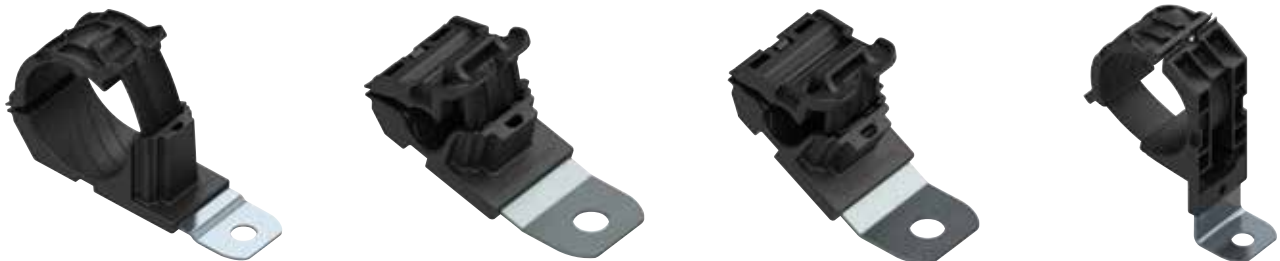

Ratchet P Clamp

For bundle diameters from ¼" to ½"

The Ratchet P Clamp family offers versatility when managing wires, cables and hoses. The robust design and durable materials make it ideal for heavy duty applications, both indoors and out. The one-piece adjustable clamp can be closed by hand to the desired diameter. The release feature provides easy and nondestructive removal of cables by simply using a flat head screwdriver. This nondestructive release allows the clamp to be reused without removing or replacing any bolts or screws. The Ratchet P Clamp is offered in four sizes and in multiple mounting configurations.

Features and Benefits

- One-piece ratchet closure design allows for easy installation during pre- or final assembly.
- Four sizes and multiple configurations handle a wide range of diameters and applications, reducing part inventory.
- Clamp interior is designed to guide and center bundle to reduce pinching.
- Easy release feature allows for quick adjustments and maintenance.
- Impact modified, heat and UV stabilized PA66 provides long-term durability, indoors and out.
- Steel mounting plate tolerates high torque mounting and is treated to resist chemicals and salt spray.



MATERIAL	Polyamide 6.6 high impact modified, heat and UV stabilized (PA66HIRHSUV)
Operating Temperature	-40°F to +257°F (-40°C to +125°C)
Flammability	UL94 HB

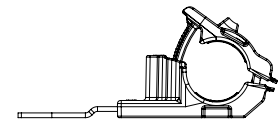
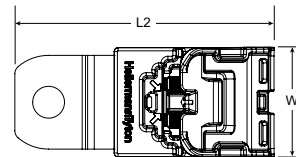

PART NO.	Type	Bundle Diameter Min.	Bundle Diameter Max.	Minimum Tensile Strength	Mounting Hole Centers	Mounting Hole Diameter D	Angle/Length	Width W	Length L2	Pkg. Qty.
		in. (mm)	in. (mm)	lbs. (N)	in. (mm)	in. (mm)		in. (mm)	in. (mm)	
151-01637	RCA180SM6	0.24 (6.2)	0.54 (13.7)	100.0 (445.0)	1.99 (50.5)	0.256 (6.50)	180° Short	1.37 (34.9)	3.27 (83.1)	300
151-01416	RCA180SM8	0.24 (6.2)	0.54 (13.7)	100.0 (445.0)	1.99 (50.5)	0.327 (8.31)		1.37 (34.9)	3.27 (83.1)	300
151-01417	RCA180SM10	0.24 (6.2)	0.54 (13.7)	100.0 (445.0)	1.99 (50.5)	0.405 (10.29)		1.37 (34.9)	3.27 (83.1)	300
151-01418	RCA180SM12	0.24 (6.2)	0.54 (13.7)	100.0 (445.0)	1.99 (50.5)	0.510 (12.95)		1.37 (34.9)	3.27 (83.1)	300
151-01638	RCA180MM6	0.24 (6.2)	0.54 (13.7)	100.0 (445.0)	2.85 (72.5)	0.256 (6.50)	180° Medium	1.37 (34.9)	4.14 (105.1)	200
151-01419	RCA180MM8	0.24 (6.2)	0.54 (13.7)	100.0 (445.0)	2.85 (72.5)	0.327 (8.31)		1.37 (34.9)	4.14 (105.1)	200
151-01420	RCA180MM10	0.24 (6.2)	0.54 (13.7)	100.0 (445.0)	2.85 (72.5)	0.405 (10.29)		1.37 (34.9)	4.14 (105.1)	200
151-01421	RCA180MM12	0.24 (6.2)	0.54 (13.7)	100.0 (445.0)	2.85 (72.5)	0.510 (12.95)		1.37 (34.9)	4.14 (105.1)	200
151-01639	RCA180LM6	0.24 (6.2)	0.54 (13.7)	100.0 (445.0)	3.99 (101.5)	0.256 (6.50)	180° Long	1.37 (34.9)	5.28 (134.1)	200
151-01422	RCA180LM8	0.24 (6.2)	0.54 (13.7)	100.0 (445.0)	3.99 (101.5)	0.327 (8.31)		1.37 (34.9)	5.28 (134.1)	200
151-01423	RCA180LM10	0.24 (6.2)	0.54 (13.7)	100.0 (445.0)	3.99 (101.5)	0.405 (10.29)		1.37 (34.9)	5.28 (134.1)	200
151-01424	RCA180LM12	0.24 (6.2)	0.54 (13.7)	100.0 (445.0)	3.99 (101.5)	0.510 (12.95)		1.37 (34.9)	5.28 (134.1)	200
151-01640	RCA15SM6	0.24 (6.2)	0.54 (13.7)	100.0 (445.0)	2.15 (54.7)	0.256 (6.50)	15° Short	1.37 (34.9)	3.42 (86.9)	300
151-01425	RCA15SM8	0.24 (6.2)	0.54 (13.7)	100.0 (445.0)	2.15 (54.7)	0.327 (8.31)		1.37 (34.9)	3.42 (86.9)	300
151-01426	RCA15SM10	0.24 (6.2)	0.54 (13.7)	100.0 (445.0)	2.15 (54.7)	0.405 (10.29)		1.37 (34.9)	3.42 (86.9)	300
151-01427	RCA15SM12	0.24 (6.2)	0.54 (13.7)	100.0 (445.0)	2.15 (54.7)	0.510 (12.95)		1.37 (34.9)	3.42 (86.9)	300
151-01641	RCA30SM6	0.24 (6.2)	0.54 (13.7)	100.0 (445.0)	1.88 (47.7)	0.256 (6.50)	30° Short	1.37 (34.9)	3.09 (78.5)	300
151-01428	RCA30SM8	0.24 (6.2)	0.54 (13.7)	100.0 (445.0)	1.88 (47.7)	0.327 (8.31)		1.37 (34.9)	3.09 (78.5)	300
151-01429	RCA30SM10	0.24 (6.2)	0.54 (13.7)	100.0 (445.0)	1.88 (47.7)	0.405 (10.29)		1.37 (34.9)	3.09 (78.5)	300
151-01430	RCA30SM12	0.24 (6.2)	0.54 (13.7)	100.0 (445.0)	1.88 (47.7)	0.510 (12.95)		1.37 (34.9)	3.09 (78.5)	300
151-01642	RCA30LM6	0.24 (6.2)	0.54 (13.7)	100.0 (445.0)	2.85 (72.4)	0.256 (6.50)	30° Long	1.37 (34.9)	4.06 (103.2)	200
151-01431	RCA30LM8	0.24 (6.2)	0.54 (13.7)	100.0 (445.0)	2.85 (72.4)	0.327 (8.31)		1.37 (34.9)	4.06 (103.2)	200
151-01432	RCA30LM10	0.24 (6.2)	0.54 (13.7)	100.0 (445.0)	2.85 (72.4)	0.405 (10.29)		1.37 (34.9)	4.06 (103.2)	200
151-01433	RCA30LM12	0.24 (6.2)	0.54 (13.7)	100.0 (445.0)	2.85 (72.4)	0.510 (12.95)		1.37 (34.9)	4.06 (103.2)	200
151-01643	RCA90SM6	0.24 (6.2)	0.54 (13.7)	100.0 (445.0)	0.98 (24.9)	0.256 (6.50)	90° Short	1.37 (34.9)	2.71 (68.8)	300
151-01434	RCA90SM8	0.24 (6.2)	0.54 (13.7)	100.0 (445.0)	0.98 (24.9)	0.327 (8.31)		1.37 (34.9)	2.71 (68.8)	300
151-01435	RCA90SM10	0.24 (6.2)	0.54 (13.7)	100.0 (445.0)	0.98 (24.9)	0.405 (10.29)		1.37 (34.9)	2.71 (68.8)	300
151-01436	RCA90SM12	0.24 (6.2)	0.54 (13.7)	100.0 (445.0)	0.98 (24.9)	0.510 (12.95)		1.37 (34.9)	2.71 (68.8)	300
151-01644	RCA90LM6	0.24 (6.2)	0.54 (13.7)	100.0 (445.0)	0.98 (24.9)	0.256 (6.50)	90° Long	1.37 (34.9)	3.81 (96.8)	200
151-01437	RCA90LM8	0.24 (6.2)	0.54 (13.7)	100.0 (445.0)	0.98 (24.9)	0.327 (8.31)		1.37 (34.9)	3.81 (96.8)	200
151-01438	RCA90LM10	0.24 (6.2)	0.54 (13.7)	100.0 (445.0)	0.98 (24.9)	0.405 (10.29)		1.37 (34.9)	3.81 (96.8)	200
151-01439	RCA90LM12	0.24 (6.2)	0.54 (13.7)	100.0 (445.0)	0.98 (24.9)	0.510 (12.95)		1.37 (34.9)	3.81 (96.8)	200

Use Part No. for ordering and Type for specification purposes.

Bundling & Securing Solutions

Ratchet P Clamp - Size B

Ratchet P Clamp

For bundle diameters from 1/2" to 3/4"

The Ratchet P Clamp family offers versatility when managing wires, cables and hoses. The robust design and durable materials make it ideal for heavy duty applications, both indoors and out. The one-piece adjustable clamp can be closed by hand to the desired diameter. The release feature provides easy and nondestructive removal of cables by simply using a flat head screwdriver. This nondestructive release allows the clamp to be reused without removing or replacing any bolts or screws. The Ratchet P Clamp is offered in four sizes and in multiple mounting configurations.

Features and Benefits

- One-piece ratchet closure design allows for easy installation during pre- or final assembly.
- Four sizes and multiple configurations handle a wide range of diameters and applications, reducing part inventory.
- Clamp interior is designed to guide and center bundle to reduce pinching.
- Easy release feature allows for quick adjustments and maintenance.
- Impact modified, heat and UV stabilized PA66 provides long-term durability, indoors and out.
- Steel mounting plate tolerates high torque mounting and is treated to resist chemicals and salt spray.



MATERIAL	Polyamide 6.6 high impact modified, heat and UV stabilized (PA66HIRHSUV)
Operating Temperature	-40°F to +257°F (-40°C to +125°C)
Flammability	UL94 HB

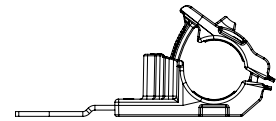
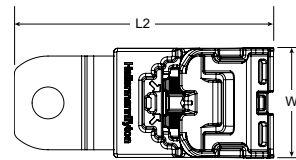

PART NO.	Type	Bundle Diameter Min.	Bundle Diameter Max.	Minimum Tensile Strength	Mounting Hole Centers	Mounting Hole Diameter D	Angle/Length	Width W	Length L2	Pkg. Qty.
		in. (mm)	in. (mm)					in. (mm)	in. (mm)	
151-01645	RCB180SM6	0.50 (12.7)	0.77 (19.5)	100.0 (445.0)	2.08 (52.8)	0.256 (6.50)	180° Short	1.37 (34.9)	3.27 (83.1)	280
151-01440	RCB180SM8	0.50 (12.7)	0.77 (19.5)	100.0 (445.0)	2.08 (52.8)	0.327 (8.31)		1.37 (34.9)	3.27 (83.1)	280
151-01390	RCB180SM10	0.50 (12.7)	0.77 (19.5)	100.0 (445.0)	2.08 (52.8)	0.405 (10.29)		1.37 (34.9)	3.27 (83.1)	280
151-01441	RCB180SM12	0.50 (12.7)	0.77 (19.5)	100.0 (445.0)	2.08 (52.8)	0.510 (12.95)		1.37 (34.9)	3.27 (83.1)	280
151-01646	RCB180MM6	0.50 (12.7)	0.77 (19.5)	100.0 (445.0)	2.94 (74.8)	0.256 (6.50)	180° Medium	1.37 (34.9)	4.14 (105.1)	200
151-01442	RCB180MM8	0.50 (12.7)	0.77 (19.5)	100.0 (445.0)	2.94 (74.8)	0.327 (8.31)		1.37 (34.9)	4.14 (105.1)	200
151-01443	RCB180MM10	0.50 (12.7)	0.77 (19.5)	100.0 (445.0)	2.94 (74.8)	0.405 (10.29)		1.37 (34.9)	4.14 (105.1)	200
151-01444	RCB180MM12	0.50 (12.7)	0.77 (19.5)	100.0 (445.0)	2.94 (74.8)	0.510 (12.95)		1.37 (34.9)	4.14 (105.1)	200
151-01647	RCB180LM6	0.50 (12.7)	0.77 (19.5)	100.0 (445.0)	4.08 (103.8)	0.256 (6.50)	180° Long	1.37 (34.9)	5.28 (134.1)	200
151-01445	RCB180LM8	0.50 (12.7)	0.77 (19.5)	100.0 (445.0)	4.08 (103.8)	0.327 (8.31)		1.37 (34.9)	5.28 (134.1)	200
151-01446	RCB180LM10	0.50 (12.7)	0.77 (19.5)	100.0 (445.0)	4.08 (103.8)	0.405 (10.29)		1.37 (34.9)	5.28 (134.1)	200
151-01447	RCB180LM12	0.50 (12.7)	0.77 (19.5)	100.0 (445.0)	4.08 (103.8)	0.510 (12.95)		1.37 (34.9)	5.28 (134.1)	200
151-01648	RCB15SM6	0.50 (12.7)	0.77 (19.5)	100.0 (445.0)	2.22 (56.5)	0.256 (6.50)	15° Short	1.37 (34.9)	3.42 (86.9)	280
151-01448	RCB15SM8	0.50 (12.7)	0.77 (19.5)	100.0 (445.0)	2.22 (56.5)	0.327 (8.31)		1.37 (34.9)	3.42 (86.9)	280
151-01449	RCB15SM10	0.50 (12.7)	0.77 (19.5)	100.0 (445.0)	2.22 (56.5)	0.405 (10.29)		1.37 (34.9)	3.42 (86.9)	280
151-01450	RCB15SM12	0.50 (12.7)	0.77 (19.5)	100.0 (445.0)	2.22 (56.5)	0.510 (12.95)		1.37 (34.9)	3.42 (86.9)	280
151-01649	RCB30SM6	0.50 (12.7)	0.77 (19.5)	100.0 (445.0)	1.92 (48.8)	0.256 (6.50)	30° Short	1.37 (34.9)	3.09 (78.5)	280
151-01451	RCB30SM8	0.50 (12.7)	0.77 (19.5)	100.0 (445.0)	1.92 (48.8)	0.327 (8.31)		1.37 (34.9)	3.09 (78.5)	280
151-01452	RCB30SM10	0.50 (12.7)	0.77 (19.5)	100.0 (445.0)	1.92 (48.8)	0.405 (10.29)		1.37 (34.9)	3.09 (78.5)	280
151-01453	RCB30SM12	0.50 (12.7)	0.77 (19.5)	100.0 (445.0)	1.92 (48.8)	0.510 (12.95)		1.37 (34.9)	3.09 (78.5)	280
151-01650	RCB30LM6	0.50 (12.7)	0.77 (19.5)	100.0 (445.0)	2.89 (73.5)	0.256 (6.50)	30° Long	1.37 (34.9)	4.06 (103.2)	200
151-01454	RCB30LM8	0.50 (12.7)	0.77 (19.5)	100.0 (445.0)	2.89 (73.5)	0.327 (8.31)		1.37 (34.9)	4.06 (103.2)	200
151-01455	RCB30LM10	0.50 (12.7)	0.77 (19.5)	100.0 (445.0)	2.89 (73.5)	0.405 (10.29)		1.37 (34.9)	4.06 (103.2)	200
151-01456	RCB30LM12	0.50 (12.7)	0.77 (19.5)	100.0 (445.0)	2.89 (73.5)	0.510 (12.95)		1.37 (34.9)	4.06 (103.2)	200
151-01651	RCB90SM6	0.50 (12.7)	0.77 (19.5)	100.0 (445.0)	1.05 (26.7)	0.256 (6.50)	90° Short	1.37 (34.9)	2.71 (68.8)	280
151-01457	RCB90SM8	0.50 (12.7)	0.77 (19.5)	100.0 (445.0)	1.05 (26.7)	0.327 (8.31)		1.37 (34.9)	2.71 (68.8)	280
151-01458	RCB90SM10	0.50 (12.7)	0.77 (19.5)	100.0 (445.0)	1.05 (26.7)	0.405 (10.29)		1.37 (34.9)	2.71 (68.8)	280
151-01459	RCB90SM12	0.50 (12.7)	0.77 (19.5)	100.0 (445.0)	1.05 (26.7)	0.510 (12.95)		1.37 (34.9)	2.71 (68.8)	280
151-01652	RCB90LM6	0.50 (12.7)	0.77 (19.5)	100.0 (445.0)	1.05 (26.7)	0.256 (6.50)	90° Long	1.37 (34.9)	3.81 (96.8)	200
151-01460	RCB90LM8	0.50 (12.7)	0.77 (19.5)	100.0 (445.0)	1.05 (26.7)	0.327 (8.31)		1.37 (34.9)	3.81 (96.8)	200
151-01461	RCB90LM10	0.50 (12.7)	0.77 (19.5)	100.0 (445.0)	1.05 (26.7)	0.405 (10.29)		1.37 (34.9)	3.81 (96.8)	200
151-01462	RCB90LM12	0.50 (12.7)	0.77 (19.5)	100.0 (445.0)	1.05 (26.7)	0.510 (12.95)		1.37 (34.9)	3.81 (96.8)	200

Use Part No. for ordering and Type for specification purposes.

Ratchet P Clamp

For bundle diameters from $\frac{3}{4}$ " to $1\frac{3}{8}$ "

The Ratchet P Clamp family offers versatility when managing wires, cables and hoses. The robust design and durable materials make it ideal for heavy duty applications, both indoors and out. The one-piece adjustable clamp can be closed by hand to the desired diameter. The release feature provides easy and nondestructive removal of cables by simply using a flat head screwdriver. This nondestructive release allows the clamp to be reused without removing or replacing any bolts or screws. The Ratchet P Clamp is offered in four sizes and in multiple mounting configurations.

Features and Benefits

- One-piece ratchet closure design allows for easy installation during pre- or final assembly.
- Four sizes and multiple configurations handle a wide range of diameters and applications, reducing part inventory.
- Clamp interior is designed to guide and center bundle to reduce pinching.
- Easy release feature allows for quick adjustments and maintenance.
- Impact modified, heat and UV stabilized PA66 provides long-term durability, indoors and out.
- Steel mounting plate tolerates high torque mounting and is treated to resist chemicals and salt spray.



MATERIAL	Polyamide 6.6 high impact modified, heat and UV stabilized (PA66HIRHSUV)
Operating Temperature	-40°F to +257°F (-40°C to +125°C)
Flammability	UL94 HB

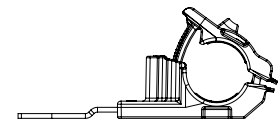
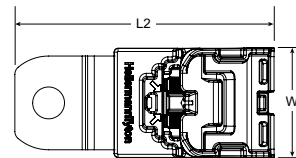

PART NO.	Type	Bundle Diameter Min.	Bundle Diameter Max.	Minimum Tensile Strength	Mounting Hole Centers	Mounting Hole Diameter D	Angle/Length	Width W	Length L2	Pkg. Qty.
		in. (mm)	in. (mm)	lbs. (N)	in. (mm)	in. (mm)		in. (mm)	in. (mm)	
151-01653	RCC180SM6	0.76 (19.4)	1.42 (36.0)	100.0 (445.0)	2.45 (62.3)	0.256 (6.50)	180° Short	1.37 (34.9)	4.06 (103.0)	160
151-01474	RCC180SM8	0.76 (19.4)	1.42 (36.0)	100.0 (445.0)	2.45 (62.3)	0.327 (8.31)		1.37 (34.9)	4.06 (103.0)	160
151-01475	RCC180SM10	0.76 (19.4)	1.42 (36.0)	100.0 (445.0)	2.45 (62.3)	0.405 (10.29)		1.37 (34.9)	4.06 (103.0)	160
151-01476	RCC180SM12	0.76 (19.4)	1.42 (36.0)	100.0 (445.0)	2.45 (62.3)	0.510 (12.95)		1.37 (34.9)	4.06 (103.0)	160
151-01654	RCC180MM6	0.76 (19.4)	1.42 (36.0)	100.0 (445.0)	3.32 (84.3)	0.256 (6.50)	180° Medium	1.37 (34.9)	4.92 (125.0)	140
151-01477	RCC180MM8	0.76 (19.4)	1.42 (36.0)	100.0 (445.0)	3.32 (84.3)	0.327 (8.31)		1.37 (34.9)	4.92 (125.0)	140
151-01478	RCC180MM10	0.76 (19.4)	1.42 (36.0)	100.0 (445.0)	3.32 (84.3)	0.405 (10.29)		1.37 (34.9)	4.92 (125.0)	140
151-01479	RCC180MM12	0.76 (19.4)	1.42 (36.0)	100.0 (445.0)	3.32 (84.3)	0.510 (12.95)		1.37 (34.9)	4.92 (125.0)	140
151-01655	RCC180LM6	0.76 (19.4)	1.42 (36.0)	100.0 (445.0)	4.46 (113.3)	0.256 (6.50)	180° Long	1.37 (34.9)	6.06 (154.0)	140
151-01480	RCC180LM8	0.76 (19.4)	1.42 (36.0)	100.0 (445.0)	4.46 (113.3)	0.327 (8.31)		1.37 (34.9)	6.06 (154.0)	140
151-01481	RCC180LM10	0.76 (19.4)	1.42 (36.0)	100.0 (445.0)	4.46 (113.3)	0.405 (10.29)		1.37 (34.9)	6.06 (154.0)	140
151-01482	RCC180LM12	0.76 (19.4)	1.42 (36.0)	100.0 (445.0)	4.46 (113.3)	0.510 (12.95)		1.37 (34.9)	6.06 (154.0)	140
151-01656	RCC15SM6	0.76 (19.4)	1.42 (36.0)	100.0 (445.0)	2.45 (62.3)	0.256 (6.50)	15° Short	1.37 (34.9)	4.07 (103.5)	160
151-01483	RCC15SM8	0.76 (19.4)	1.42 (36.0)	100.0 (445.0)	2.45 (62.3)	0.327 (8.31)		1.37 (34.9)	4.07 (103.5)	160
151-01484	RCC15SM10	0.76 (19.4)	1.42 (36.0)	100.0 (445.0)	2.45 (62.3)	0.405 (10.29)		1.37 (34.9)	4.07 (103.5)	160
151-01485	RCC15SM12	0.76 (19.4)	1.42 (36.0)	100.0 (445.0)	2.45 (62.3)	0.510 (12.95)		1.37 (34.9)	4.07 (103.5)	160
151-01657	RCC30SM6	0.76 (19.4)	1.42 (36.0)	100.0 (445.0)	1.99 (50.5)	0.256 (6.50)	30° Short	1.37 (34.9)	3.55 (90.2)	160
151-01486	RCC30SM8	0.76 (19.4)	1.42 (36.0)	100.0 (445.0)	1.99 (50.5)	0.327 (8.31)		1.37 (34.9)	3.55 (90.2)	160
151-01487	RCC30SM10	0.76 (19.4)	1.42 (36.0)	100.0 (445.0)	1.99 (50.5)	0.405 (10.29)		1.37 (34.9)	3.55 (90.2)	160
151-01488	RCC30SM12	0.76 (19.4)	1.42 (36.0)	100.0 (445.0)	1.99 (50.5)	0.510 (12.95)		1.37 (34.9)	3.55 (90.2)	160
151-01658	RCC30LM6	0.76 (19.4)	1.42 (36.0)	100.0 (445.0)	2.96 (75.2)	0.256 (6.50)	30° Long	1.37 (34.9)	4.52 (114.9)	140
151-01489	RCC30LM8	0.76 (19.4)	1.42 (36.0)	100.0 (445.0)	2.96 (75.2)	0.327 (8.31)		1.37 (34.9)	4.52 (114.9)	140
151-01490	RCC30LM10	0.76 (19.4)	1.42 (36.0)	100.0 (445.0)	2.96 (75.2)	0.405 (10.29)		1.37 (34.9)	4.52 (114.9)	140
151-01491	RCC30LM12	0.76 (19.4)	1.42 (36.0)	100.0 (445.0)	2.96 (75.2)	0.510 (12.95)		1.37 (34.9)	4.52 (114.9)	140
151-01659	RCC90SM6	0.76 (19.4)	1.42 (36.0)	100.0 (445.0)	1.57 (39.9)	0.256 (6.50)	90° Short	1.37 (34.9)	3.99 (101.2)	160
151-01492	RCC90SM8	0.76 (19.4)	1.42 (36.0)	100.0 (445.0)	1.57 (39.9)	0.327 (8.31)		1.37 (34.9)	3.99 (101.2)	160
151-01493	RCC90SM10	0.76 (19.4)	1.42 (36.0)	100.0 (445.0)	1.57 (39.9)	0.405 (10.29)		1.37 (34.9)	3.99 (101.2)	160
151-01494	RCC90SM12	0.76 (19.4)	1.42 (36.0)	100.0 (445.0)	1.57 (39.9)	0.510 (12.95)		1.37 (34.9)	3.99 (101.2)	160
151-01660	RCC90LM6	0.76 (19.4)	1.42 (36.0)	100.0 (445.0)	1.57 (39.9)	0.256 (6.50)	90° Long	1.37 (34.9)	5.09 (129.2)	140
151-01495	RCC90LM8	0.76 (19.4)	1.42 (36.0)	100.0 (445.0)	1.57 (39.9)	0.327 (8.31)		1.37 (34.9)	5.09 (129.2)	140
151-01496	RCC90LM10	0.76 (19.4)	1.42 (36.0)	100.0 (445.0)	1.57 (39.9)	0.405 (10.29)		1.37 (34.9)	5.09 (129.2)	140
151-01497	RCC90LM12	0.76 (19.4)	1.42 (36.0)	100.0 (445.0)	1.57 (39.9)	0.510 (12.95)		1.37 (34.9)	5.09 (129.2)	140

Use Part No. for ordering and Type for specification purposes.

Bundling & Securing Solutions

Ratchet P Clamp - Size D

Ratchet P Clamp

For bundle diameters from 1³/₈" to 2"

The Ratchet P Clamp family offers versatility when managing wires, cables and hoses. The robust design and durable materials make it ideal for heavy duty applications, both indoors and out. The one-piece adjustable clamp can be closed by hand to the desired diameter. The release feature provides easy and nondestructive removal of cables by simply using a flat head screwdriver. This nondestructive release allows the clamp to be reused without removing or replacing any bolts or screws. The Ratchet P Clamp is offered in four sizes and in multiple mounting configurations.

Features and Benefits

- One-piece ratchet closure design allows for easy installation during pre- or final assembly.
- Four sizes and multiple configurations handle a wide range of diameters and applications, reducing part inventory.
- Clamp interior is designed to guide and center bundle to reduce pinching.
- Easy release feature allows for quick adjustments and maintenance.
- Impact modified, heat and UV stabilized PA66 provides long-term durability, indoors and out.
- Steel mounting plate tolerates high torque mounting and is treated to resist chemicals and salt spray.



MATERIAL	Polyamide 6.6 high impact modified, heat and UV stabilized (PA66HIRHSUV)
Operating Temperature	-40°F to +257°F (-40°C to +125°C)
Flammability	UL94 HB

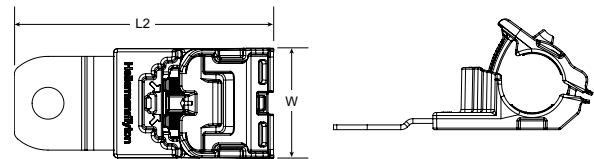

PART NO.	Type	Bundle Diameter Min.	Bundle Diameter Max.	Minimum Tensile Strength	Mounting Hole Centers	Mounting Hole Diameter D	Angle/Length	Width W	Length L2	Pkg. Qty.
		in. (mm)	in. (mm)	lbs. (N)	in. (mm)	in. (mm)		in. (mm)	in. (mm)	
151-01661	RCD180SM6	1.42 (36.0)	2.00 (51.0)	100.0 (445.0)	2.76 (70.0)	0.256 (6.50)	180° Short	1.37 (34.9)	4.55 (115.5)	160
151-01499	RCD180SM8	1.42 (36.0)	2.00 (51.0)	100.0 (445.0)	2.76 (70.0)	0.327 (8.31)		1.37 (34.9)	4.55 (115.5)	160
151-01501	RCD180SM10	1.42 (36.0)	2.00 (51.0)	100.0 (445.0)	2.76 (70.0)	0.405 (10.29)		1.37 (34.9)	4.55 (115.5)	160
151-01502	RCD180SM12	1.42 (36.0)	2.00 (51.0)	100.0 (445.0)	2.76 (70.0)	0.510 (12.95)		1.37 (34.9)	4.55 (115.5)	160
151-01662	RCD180MM6	1.42 (36.0)	2.00 (51.0)	100.0 (445.0)	3.62 (92.0)	0.256 (6.50)	180° Medium	1.37 (34.9)	5.41 (137.5)	140
151-01503	RCD180MM8	1.42 (36.0)	2.00 (51.0)	100.0 (445.0)	3.62 (92.0)	0.327 (8.31)		1.37 (34.9)	5.41 (137.5)	140
151-01504	RCD180MM10	1.42 (36.0)	2.00 (51.0)	100.0 (445.0)	3.62 (92.0)	0.405 (10.29)		1.37 (34.9)	5.41 (137.5)	140
151-01505	RCD180MM12	1.42 (36.0)	2.00 (51.0)	100.0 (445.0)	3.62 (92.0)	0.510 (12.95)		1.37 (34.9)	5.41 (137.5)	140
151-01663	RCD180LM6	1.42 (36.0)	2.00 (51.0)	100.0 (445.0)	4.76 (121.0)	0.256 (6.50)	180° Long	1.37 (34.9)	6.56 (166.5)	140
151-01506	RCD180LM8	1.42 (36.0)	2.00 (51.0)	100.0 (445.0)	4.76 (121.0)	0.327 (8.31)		1.37 (34.9)	6.56 (166.5)	140
151-01507	RCD180LM10	1.42 (36.0)	2.00 (51.0)	100.0 (445.0)	4.76 (121.0)	0.405 (10.29)		1.37 (34.9)	6.56 (166.5)	140
151-01508	RCD180LM12	1.42 (36.0)	2.00 (51.0)	100.0 (445.0)	4.76 (121.0)	0.510 (12.95)		1.37 (34.9)	6.56 (166.5)	140
151-01664	RCD15SM6	1.42 (36.0)	2.00 (51.0)	100.0 (445.0)	2.72 (69.1)	0.256 (6.50)	15° Short	1.37 (34.9)	4.56 (115.9)	160
151-01509	RCD15SM8	1.42 (36.0)	2.00 (51.0)	100.0 (445.0)	2.72 (69.1)	0.327 (8.31)		1.37 (34.9)	4.56 (115.9)	160
151-01510	RCD15SM10	1.42 (36.0)	2.00 (51.0)	100.0 (445.0)	2.72 (69.1)	0.405 (10.29)		1.37 (34.9)	4.56 (115.9)	160
151-01511	RCD15SM12	1.42 (36.0)	2.00 (51.0)	100.0 (445.0)	2.72 (69.1)	0.510 (12.95)		1.37 (34.9)	4.56 (115.9)	160
151-01665	RCD30SM6	1.42 (36.0)	2.00 (51.0)	100.0 (445.0)	2.20 (55.9)	0.256 (6.50)	30° Short	1.37 (34.9)	4.03 (102.4)	160
151-01512	RCD30SM8	1.42 (36.0)	2.00 (51.0)	100.0 (445.0)	2.20 (55.9)	0.327 (8.31)		1.37 (34.9)	4.03 (102.4)	160
151-01513	RCD30SM10	1.42 (36.0)	2.00 (51.0)	100.0 (445.0)	2.20 (55.9)	0.405 (10.29)		1.37 (34.9)	4.03 (102.4)	160
151-01514	RCD30SM12	1.42 (36.0)	2.00 (51.0)	100.0 (445.0)	2.20 (55.9)	0.510 (12.95)		1.37 (34.9)	4.03 (102.4)	160
151-01666	RCD30LM6	1.42 (36.0)	2.00 (51.0)	100.0 (445.0)	3.17 (80.5)	0.256 (6.50)	30° Long	1.37 (34.9)	5.00 (127.0)	140
151-01515	RCD30LM8	1.42 (36.0)	2.00 (51.0)	100.0 (445.0)	3.17 (80.5)	0.327 (8.31)		1.37 (34.9)	5.00 (127.0)	140
151-01516	RCD30LM10	1.42 (36.0)	2.00 (51.0)	100.0 (445.0)	3.17 (80.5)	0.405 (10.29)		1.37 (34.9)	5.00 (127.0)	140
151-01517	RCD30LM12	1.42 (36.0)	2.00 (51.0)	100.0 (445.0)	3.17 (80.5)	0.510 (12.95)		1.37 (34.9)	5.00 (127.0)	140
151-01667	RCD90SM6	1.42 (36.0)	2.00 (51.0)	100.0 (445.0)	1.67 (42.4)	0.256 (6.50)	90° Short	1.37 (34.9)	3.49 (88.7)	160
151-01518	RCD90SM8	1.42 (36.0)	2.00 (51.0)	100.0 (445.0)	1.67 (42.4)	0.327 (8.31)		1.37 (34.9)	3.49 (88.7)	160
151-01519	RCD90SM10	1.42 (36.0)	2.00 (51.0)	100.0 (445.0)	1.67 (42.4)	0.405 (10.29)		1.37 (34.9)	3.49 (88.7)	160
151-01520	RCD90SM12	1.42 (36.0)	2.00 (51.0)	100.0 (445.0)	1.67 (42.4)	0.510 (12.95)		1.37 (34.9)	3.49 (88.7)	160
151-01628	RCD90LM6	1.42 (36.0)	2.00 (51.0)	100.0 (445.0)	1.67 (42.4)	0.256 (6.50)	90° Long	1.37 (34.9)	4.59 (116.7)	140
151-01521	RCD90LM8	1.42 (36.0)	2.00 (51.0)	100.0 (445.0)	1.67 (42.4)	0.327 (8.31)		1.37 (34.9)	4.59 (116.7)	140
151-01522	RCD90LM10	1.42 (36.0)	2.00 (51.0)	100.0 (445.0)	1.67 (42.4)	0.405 (10.29)		1.37 (34.9)	4.59 (116.7)	140
151-01523	RCD90LM12	1.42 (36.0)	2.00 (51.0)	100.0 (445.0)	1.67 (42.4)	0.510 (12.95)		1.37 (34.9)	4.59 (116.7)	140

Use Part No. for ordering and Type for specification purposes.

Bundling & Securing Solutions

Stainless Steel Ratchet P Clamp - Size A

Stainless Steel Ratchet P Clamp

For bundle diameters from ¼" to ½"

The Ratchet P Clamp family offers versatility when managing wires, cables and hoses. The robust design and durable materials make it ideal for heavy duty applications, both indoors and out. The one-piece adjustable clamp can be closed by hand to the desired diameter. The release feature provides easy and nondestructive removal of cables by simply using a flat head screwdriver. This nondestructive release allows the clamp to be reused without removing or replacing any bolts or screws. The Ratchet P Clamp is offered in four sizes and in multiple mounting configurations.

Features and Benefits

- One-piece ratchet closure design allows for easy installation during pre- or final assembly.
- Four sizes and multiple configurations handle a wide range of diameters and applications, reducing part inventory.
- Clamp interior is designed to guide and center bundle to reduce pinching.
- Easy release feature allows for quick adjustments and maintenance.
- Impact modified, heat and UV stabilized PA66 provides long-term durability, indoors and out.
- Steel mounting plate tolerates high torque mounting and is treated to resist chemicals and salt spray.



MATERIAL	Polyamide 6.6 high impact modified, heat and UV stabilized (PA66HIRHSUV)
Operating Temperature	-40°F to +257°F (-40°C to +125°C)
Flammability	UL94 HB

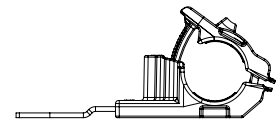
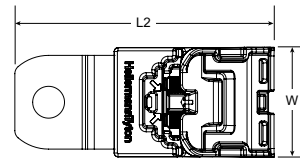
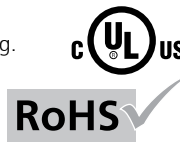

PART NO.	Type	Bundle Diameter Min.	Bundle Diameter Max.	Minimum Tensile Strength	Mounting Hole Centers	Mounting Hole Diameter D	Angle/Length	Width W	Length L2	Pkg. Qty.
		in. (mm)	in. (mm)	lbs. (N)	in. (mm)	in. (mm)		in. (mm)	in. (mm)	
151-01911	RCA180SM6SS	0.24 (6.2)	0.54 (13.7)	100.0 (445.0)	1.99 (50.5)	0.256 (6.50)	180° Short	1.37 (34.9)	3.27 (83.1)	300
151-01912	RCA180SM8SS	0.24 (6.2)	0.54 (13.7)	100.0 (445.0)	1.99 (50.5)	0.327 (8.31)		1.37 (34.9)	3.27 (83.1)	300
151-01913	RCA180SM10SS	0.24 (6.2)	0.54 (13.7)	100.0 (445.0)	1.99 (50.5)	0.405 (10.29)		1.37 (34.9)	3.27 (83.1)	300
151-01914	RCA180SM12SS	0.24 (6.2)	0.54 (13.7)	100.0 (445.0)	1.99 (50.5)	0.510 (12.95)		1.37 (34.9)	3.27 (83.1)	300
151-01915	RCA180MM6SS	0.24 (6.2)	0.54 (13.7)	100.0 (445.0)	2.85 (72.5)	0.256 (6.50)	180° Medium	1.37 (34.9)	4.14 (105.1)	200
151-01916	RCA180MM8SS	0.24 (6.2)	0.54 (13.7)	100.0 (445.0)	2.85 (72.5)	0.327 (8.31)		1.37 (34.9)	4.14 (105.1)	200
151-01917	RCA180MM10SS	0.24 (6.2)	0.54 (13.7)	100.0 (445.0)	2.85 (72.5)	0.405 (10.29)		1.37 (34.9)	4.14 (105.1)	200
151-01918	RCA180MM12SS	0.24 (6.2)	0.54 (13.7)	100.0 (445.0)	2.85 (72.5)	0.510 (12.95)		1.37 (34.9)	4.14 (105.1)	200
151-01919	RCA180LM6SS	0.24 (6.2)	0.54 (13.7)	100.0 (445.0)	3.99 (101.5)	0.256 (6.50)	180° Long	1.37 (34.9)	5.28 (134.1)	200
151-01920	RCA180LM8SS	0.24 (6.2)	0.54 (13.7)	100.0 (445.0)	3.99 (101.5)	0.327 (8.31)		1.37 (34.9)	5.28 (134.1)	200
151-01921	RCA180LM10SS	0.24 (6.2)	0.54 (13.7)	100.0 (445.0)	3.99 (101.5)	0.405 (10.29)		1.37 (34.9)	5.28 (134.1)	200
151-01922	RCA180LM12SS	0.24 (6.2)	0.54 (13.7)	100.0 (445.0)	3.99 (101.5)	0.510 (12.95)		1.37 (34.9)	5.28 (134.1)	200
151-01923	RCA15SM6SS	0.24 (6.2)	0.54 (13.7)	100.0 (445.0)	2.15 (54.7)	0.256 (6.50)	15° Short	1.37 (34.9)	3.42 (86.9)	300
151-01924	RCA15SM8SS	0.24 (6.2)	0.54 (13.7)	100.0 (445.0)	2.15 (54.7)	0.327 (8.31)		1.37 (34.9)	3.42 (86.9)	300
151-01925	RCA15SM10SS	0.24 (6.2)	0.54 (13.7)	100.0 (445.0)	2.15 (54.7)	0.405 (10.29)		1.37 (34.9)	3.42 (86.9)	300
151-01926	RCA15SM12SS	0.24 (6.2)	0.54 (13.7)	100.0 (445.0)	2.15 (54.7)	0.510 (12.95)		1.37 (34.9)	3.42 (86.9)	300
151-01927	RCA30SM6SS	0.24 (6.2)	0.54 (13.7)	100.0 (445.0)	1.88 (47.7)	0.256 (6.5)	30° Short	1.37 (34.9)	3.09 (78.5)	300
151-01928	RCA30SM8SS	0.24 (6.2)	0.54 (13.7)	100.0 (445.0)	1.88 (47.7)	0.327 (8.31)		1.37 (34.9)	3.09 (78.5)	300
151-01929	RCA30SM10SS	0.24 (6.2)	0.54 (13.7)	100.0 (445.0)	1.88 (47.7)	0.405 (10.29)		1.37 (34.9)	3.09 (78.5)	300
151-01930	RCA30SM12SS	0.24 (6.2)	0.54 (13.7)	100.0 (445.0)	1.88 (47.7)	0.510 (12.95)		1.37 (34.9)	3.09 (78.5)	300
151-01931	RCA30LM6SS	0.24 (6.2)	0.54 (13.7)	100.0 (445.0)	2.85 (72.4)	0.256 (6.50)	30° Long	1.37 (34.9)	4.06 (103.2)	200
151-01932	RCA30LM8SS	0.24 (6.2)	0.54 (13.7)	100.0 (445.0)	2.85 (72.4)	0.327 (8.31)		1.37 (34.9)	4.06 (103.2)	200
151-01933	RCA30LM10SS	0.24 (6.2)	0.54 (13.7)	100.0 (445.0)	2.85 (72.4)	0.405 (10.29)		1.37 (34.9)	4.06 (103.2)	200
151-01934	RCA30LM12SS	0.24 (6.2)	0.54 (13.7)	100.0 (445.0)	2.85 (72.4)	0.510 (12.95)		1.37 (34.9)	4.06 (103.2)	200
151-01935	RCA90SM6SS	0.24 (6.2)	0.54 (13.7)	100.0 (445.0)	0.98 (24.9)	0.256 (6.50)	90° Short	1.37 (34.9)	2.71 (68.8)	300
151-01936	RCA90SM8SS	0.24 (6.2)	0.54 (13.7)	100.0 (445.0)	0.98 (24.9)	0.327 (8.31)		1.37 (34.9)	2.71 (68.8)	300
151-01937	RCA90SM10SS	0.24 (6.2)	0.54 (13.7)	100.0 (445.0)	0.98 (24.9)	0.405 (10.29)		1.37 (34.9)	2.71 (68.8)	300
151-01938	RCA90SM12SS	0.24 (6.2)	0.54 (13.7)	100.0 (445.0)	0.98 (24.9)	0.510 (12.95)		1.37 (34.9)	2.71 (68.8)	300
151-01939	RCA90LM6SS	0.24 (6.2)	0.54 (13.7)	100.0 (445.0)	0.98 (24.9)	0.256 (6.50)	90° Long	1.37 (34.9)	3.81 (96.8)	200
151-01940	RCA90LM8SS	0.24 (6.2)	0.54 (13.7)	100.0 (445.0)	0.98 (24.9)	0.327 (8.31)		1.37 (34.9)	3.81 (96.8)	200
151-01941	RCA90LM10SS	0.24 (6.2)	0.54 (13.7)	100.0 (445.0)	0.98 (24.9)	0.405 (10.29)		1.37 (34.9)	3.81 (96.8)	200
151-01942	RCA90LM12SS	0.24 (6.2)	0.54 (13.7)	100.0 (445.0)	0.98 (24.9)	0.510 (12.95)		1.37 (34.9)	3.81 (96.8)	200

Use Part No. for ordering and Type for specification purposes.

Bundling & Securing Solutions

Stainless Steel Ratchet P Clamp - Size B

Stainless Steel Ratchet P Clamp

For bundle diameters from 1/2" to 3/4"

The Ratchet P Clamp family offers versatility when managing wires, cables and hoses. The robust design and durable materials make it ideal for heavy duty applications, both indoors and out. The one-piece adjustable clamp can be closed by hand to the desired diameter. The release feature provides easy and nondestructive removal of cables by simply using a flat head screwdriver. This nondestructive release allows the clamp to be reused without removing or replacing any bolts or screws. The Ratchet P Clamp is offered in four sizes and in multiple mounting configurations.

Features and Benefits

- One-piece ratchet closure design allows for easy installation during pre- or final assembly.
- Four sizes and multiple configurations handle a wide range of diameters and applications, reducing part inventory.
- Clamp interior is designed to guide and center bundle to reduce pinching.
- Easy release feature allows for quick adjustments and maintenance.
- Impact modified, heat and UV stabilized PA66 provides long-term durability, indoors and out.
- Steel mounting plate tolerates high torque mounting and is treated to resist chemicals and salt spray.



MATERIAL	Polyamide 6.6 high impact modified, heat and UV stabilized (PA66HIRHSUV)
Operating Temperature	-40°F to +257°F (-40°C to +125°C)
Flammability	UL94 HB

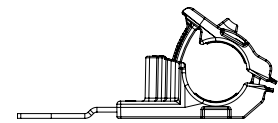
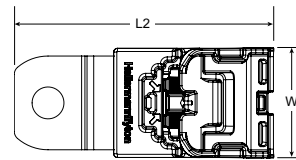

PART NO.	Type	Bundle Diameter Min.	Bundle Diameter Max.	Minimum Tensile Strength	Mounting Hole Centers	Mounting Hole Diameter D	Angle/Length	Width W	Length L2	Pkg. Qty.
		in. (mm)	in. (mm)	lbs. (N)	in. (mm)	in. (mm)		in. (mm)	in. (mm)	
151-01943	RCB180SM6SS	0.50 (12.7)	0.77 (19.5)	100.0 (445.0)	2.08 (52.8)	0.256 (6.50)	180° Short	1.37 (34.9)	3.27 (83.1)	280
151-01944	RCB180SM8SS	0.50 (12.7)	0.77 (19.5)	100.0 (445.0)	2.08 (52.8)	0.327 (8.31)		1.37 (34.9)	3.27 (83.1)	280
151-01945	RCB180SM10SS	0.50 (12.7)	0.77 (19.5)	100.0 (445.0)	2.08 (52.8)	0.405 (10.29)		1.37 (34.9)	3.27 (83.1)	280
151-01946	RCB180SM12SS	0.50 (12.7)	0.77 (19.5)	100.0 (445.0)	2.08 (52.8)	0.510 (12.95)		1.37 (34.9)	3.27 (83.1)	280
151-01947	RCB180MM6SS	0.50 (12.7)	0.77 (19.5)	100.0 (445.0)	2.94 (74.8)	0.256 (6.50)	180° Medium	1.37 (34.9)	4.14 (105.1)	200
151-01948	RCB180MM8SS	0.50 (12.7)	0.77 (19.5)	100.0 (445.0)	2.94 (74.8)	0.327 (8.31)		1.37 (34.9)	4.14 (105.1)	200
151-01949	RCB180MM10SS	0.50 (12.7)	0.77 (19.5)	100.0 (445.0)	2.94 (74.8)	0.405 (10.29)		1.37 (34.9)	4.14 (105.1)	200
151-01950	RCB180MM12SS	0.50 (12.7)	0.77 (19.5)	100.0 (445.0)	2.94 (74.8)	0.510 (12.95)		1.37 (34.9)	4.14 (105.1)	200
151-01951	RCB180LM6SS	0.50 (12.7)	0.77 (19.5)	100.0 (445.0)	4.08 (103.8)	0.256 (6.50)	180° Long	1.37 (34.9)	5.28 (134.1)	200
151-01952	RCB180LM8SS	0.50 (12.7)	0.77 (19.5)	100.0 (445.0)	4.08 (103.8)	0.327 (8.31)		1.37 (34.9)	5.28 (134.1)	200
151-01953	RCB180LM10SS	0.50 (12.7)	0.77 (19.5)	100.0 (445.0)	4.08 (103.8)	0.405 (10.29)		1.37 (34.9)	5.28 (134.1)	200
151-01954	RCB180LM12SS	0.50 (12.7)	0.77 (19.5)	100.0 (445.0)	4.08 (103.8)	0.510 (12.95)		1.37 (34.9)	5.28 (134.1)	200
151-01955	RCB15SM6SS	0.50 (12.7)	0.77 (19.5)	100.0 (445.0)	2.22 (56.5)	0.256 (6.50)	15° Short	1.37 (34.9)	3.42 (86.9)	280
151-01956	RCB15SM8SS	0.50 (12.7)	0.77 (19.5)	100.0 (445.0)	2.22 (56.5)	0.327 (8.31)		1.37 (34.9)	3.42 (86.9)	280
151-01957	RCB15SM10SS	0.50 (12.7)	0.77 (19.5)	100.0 (445.0)	2.22 (56.5)	0.405 (10.29)		1.37 (34.9)	3.42 (86.9)	280
151-01958	RCB15SM12SS	0.50 (12.7)	0.77 (19.5)	100.0 (445.0)	2.22 (56.5)	0.510 (12.95)		1.37 (34.9)	3.42 (86.9)	280
151-01959	RCB30SM6SS	0.50 (12.7)	0.77 (19.5)	100.0 (445.0)	1.92 (48.8)	0.256 (6.50)	30° Short	1.37 (34.9)	3.09 (78.5)	280
151-01960	RCB30SM8SS	0.50 (12.7)	0.77 (19.5)	100.0 (445.0)	1.92 (48.8)	0.327 (8.31)		1.37 (34.9)	3.09 (78.5)	280
151-01961	RCB30SM10SS	0.50 (12.7)	0.77 (19.5)	100.0 (445.0)	1.92 (48.8)	0.405 (10.29)		1.37 (34.9)	3.09 (78.5)	280
151-01962	RCB30SM12SS	0.50 (12.7)	0.77 (19.5)	100.0 (445.0)	1.92 (48.8)	0.510 (12.95)		1.37 (34.9)	3.09 (78.5)	280
151-01963	RCB30LM6SS	0.50 (12.7)	0.77 (19.5)	100.0 (445.0)	2.89 (73.5)	0.256 (6.50)	30° Long	1.37 (34.9)	4.06 (103.2)	200
151-01964	RCB30LM8SS	0.50 (12.7)	0.77 (19.5)	100.0 (445.0)	2.89 (73.5)	0.327 (8.31)		1.37 (34.9)	4.06 (103.2)	200
151-01965	RCB30LM10SS	0.50 (12.7)	0.77 (19.5)	100.0 (445.0)	2.89 (73.5)	0.405 (10.29)		1.37 (34.9)	4.06 (103.2)	200
151-01966	RCB30LM12SS	0.50 (12.7)	0.77 (19.5)	100.0 (445.0)	2.89 (73.5)	0.510 (12.95)		1.37 (34.9)	4.06 (103.2)	200
151-01967	RCB90SM6SS	0.50 (12.7)	0.77 (19.5)	100.0 (445.0)	1.05 (26.7)	0.256 (6.50)	90° Short	1.37 (34.9)	2.71 (68.8)	280
151-01968	RCB90SM8SS	0.50 (12.7)	0.77 (19.5)	100.0 (445.0)	1.05 (26.7)	0.327 (8.31)		1.37 (34.9)	2.71 (68.8)	280
151-01969	RCB90SM10SS	0.50 (12.7)	0.77 (19.5)	100.0 (445.0)	1.05 (26.7)	0.405 (10.29)		1.37 (34.9)	2.71 (68.8)	280
151-01970	RCB90SM12SS	0.50 (12.7)	0.77 (19.5)	100.0 (445.0)	1.05 (26.7)	0.510 (12.95)		1.37 (34.9)	2.71 (68.8)	280
151-01971	RCB90LM6SS	0.50 (12.7)	0.77 (19.5)	100.0 (445.0)	1.05 (26.7)	0.256 (6.50)	90° Long	1.37 (34.9)	3.81 (96.8)	200
151-01972	RCB90LM8SS	0.50 (12.7)	0.77 (19.5)	100.0 (445.0)	1.05 (26.7)	0.327 (8.31)		1.37 (34.9)	3.81 (96.8)	200
151-01973	RCB90LM10SS	0.50 (12.7)	0.77 (19.5)	100.0 (445.0)	1.05 (26.7)	0.405 (10.29)		1.37 (34.9)	3.81 (96.8)	200
151-01974	RCB90LM12SS	0.50 (12.7)	0.77 (19.5)	100.0 (445.0)	1.05 (26.7)	0.510 (12.95)		1.37 (34.9)	3.81 (96.8)	200

Use Part No. for ordering and Type for specification purposes.

Bundling & Securing Solutions

Stainless Steel Ratchet P Clamp - Size C

Stainless Steel Ratchet P Clamp

For bundle diameters from $\frac{3}{4}$ " to $1\frac{3}{8}$ "

The Ratchet P Clamp family offers versatility when managing wires, cables and hoses. The robust design and durable materials make it ideal for heavy duty applications, both indoors and out. The one-piece adjustable clamp can be closed by hand to the desired diameter. The release feature provides easy and nondestructive removal of cables by simply using a flat head screwdriver. This nondestructive release allows the clamp to be reused without removing or replacing any bolts or screws. The Ratchet P Clamp is offered in four sizes and in multiple mounting configurations.

Features and Benefits

- One-piece ratchet closure design allows for easy installation during pre- or final assembly.
- Four sizes and multiple configurations handle a wide range of diameters and applications, reducing part inventory.
- Clamp interior is designed to guide and center bundle to reduce pinching.
- Easy release feature allows for quick adjustments and maintenance.
- Impact modified, heat and UV stabilized PA66 provides long-term durability, indoors and out.
- Steel mounting plate tolerates high torque mounting and is treated to resist chemicals and salt spray.



MATERIAL	Polyamide 6.6 high impact modified, heat and UV stabilized (PA66HIRHSUV)
Operating Temperature	-40°F to +257°F (-40°C to +125°C)
Flammability	UL94 HB

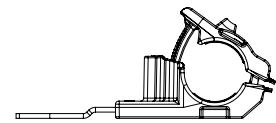
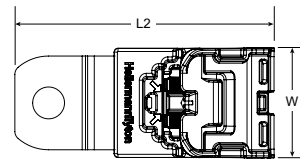

PART NO.	Type	Bundle Diameter Min.	Bundle Diameter Max.	Minimum Tensile Strength	Mounting Hole Centers	Mounting Hole Diameter D	Angle/Length	Width W	Length L2	Pkg. Qty.
		in. (mm)	in. (mm)	lbs. (N)	in. (mm)	in. (mm)		in. (mm)	in. (mm)	
151-01975	RCC180SM6SS	0.76 (19.4)	1.42 (36.0)	100.0 (445.0)	2.45 (62.3)	0.256 (6.50)	180° Short	1.37 (34.9)	4.06 (103.0)	160
151-01976	RCC180SM8SS	0.76 (19.4)	1.42 (36.0)	100.0 (445.0)	2.45 (62.3)	0.327 (8.31)		1.37 (34.9)	4.06 (103.0)	160
151-01977	RCC180SM10SS	0.76 (19.4)	1.42 (36.0)	100.0 (445.0)	2.45 (62.3)	0.405 (10.29)		1.37 (34.9)	4.06 (103.0)	160
151-01978	RCC180SM12SS	0.76 (19.4)	1.42 (36.0)	100.0 (445.0)	2.45 (62.3)	0.510 (12.95)		1.37 (34.9)	4.06 (103.0)	160
151-01979	RCC180MM6SS	0.76 (19.4)	1.42 (36.0)	100.0 (445.0)	3.32 (84.3)	0.256 (6.50)	180° Medium	1.37 (34.9)	4.92 (125.0)	140
151-01980	RCC180MM8SS	0.76 (19.4)	1.42 (36.0)	100.0 (445.0)	3.32 (84.3)	0.327 (8.31)		1.37 (34.9)	4.92 (125.0)	140
151-01981	RCC180MM10SS	0.76 (19.4)	1.42 (36.0)	100.0 (445.0)	3.32 (84.3)	0.405 (10.29)		1.37 (34.9)	4.92 (125.0)	140
151-01982	RCC180MM12SS	0.76 (19.4)	1.42 (36.0)	100.0 (445.0)	3.32 (84.3)	0.510 (12.95)		1.37 (34.9)	4.92 (125.0)	140
151-01983	RCC180LM6SS	0.76 (19.4)	1.42 (36.0)	100.0 (445.0)	4.46 (113.3)	0.256 (6.50)	180° Long	1.37 (34.9)	6.06 (154.0)	140
151-01984	RCC180LM8SS	0.76 (19.4)	1.42 (36.0)	100.0 (445.0)	4.46 (113.3)	0.327 (8.31)		1.37 (34.9)	6.06 (154.0)	140
151-01985	RCC180LM10SS	0.76 (19.4)	1.42 (36.0)	100.0 (445.0)	4.46 (113.3)	0.405 (10.29)		1.37 (34.9)	6.06 (154.0)	140
151-01986	RCC180LM12SS	0.76 (19.4)	1.42 (36.0)	100.0 (445.0)	4.46 (113.3)	0.510 (12.95)		1.37 (34.9)	6.06 (154.0)	140
151-01987	RCC15SM6SS	0.76 (19.4)	1.42 (36.0)	100.0 (445.0)	2.45 (62.3)	0.256 (6.50)	15° Short	1.37 (34.9)	4.07 (103.5)	160
151-01988	RCC15SM8SS	0.76 (19.4)	1.42 (36.0)	100.0 (445.0)	2.45 (62.3)	0.327 (8.31)		1.37 (34.9)	4.07 (103.5)	160
151-01989	RCC15SM10SS	0.76 (19.4)	1.42 (36.0)	100.0 (445.0)	2.45 (62.3)	0.405 (10.29)		1.37 (34.9)	4.07 (103.5)	160
151-01990	RCC15SM12SS	0.76 (19.4)	1.42 (36.0)	100.0 (445.0)	2.45 (62.3)	0.510 (12.95)		1.37 (34.9)	4.07 (103.5)	160
151-01991	RCC30SM6SS	0.76 (19.4)	1.42 (36.0)	100.0 (445.0)	1.99 (50.5)	0.256 (6.50)	30° Short	1.37 (34.9)	3.55 (90.2)	160
151-01992	RCC30SM8SS	0.76 (19.4)	1.42 (36.0)	100.0 (445.0)	1.99 (50.5)	0.327 (8.31)		1.37 (34.9)	3.55 (90.2)	160
151-01993	RCC30SM10SS	0.76 (19.4)	1.42 (36.0)	100.0 (445.0)	1.99 (50.5)	0.405 (10.29)		1.37 (34.9)	3.55 (90.2)	160
151-01994	RCC30SM12SS	0.76 (19.4)	1.42 (36.0)	100.0 (445.0)	1.99 (50.5)	0.510 (12.95)		1.37 (34.9)	3.55 (90.2)	160
151-01995	RCC30LM6SS	0.76 (19.4)	1.42 (36.0)	100.0 (445.0)	2.96 (75.2)	0.256 (6.50)	30° Long	1.37 (34.9)	4.52 (114.9)	140
151-01996	RCC30LM8SS	0.76 (19.4)	1.42 (36.0)	100.0 (445.0)	2.96 (75.2)	0.327 (8.31)		1.37 (34.9)	4.52 (114.9)	140
151-01997	RCC30LM10SS	0.76 (19.4)	1.42 (36.0)	100.0 (445.0)	2.96 (75.2)	0.405 (10.29)		1.37 (34.9)	4.52 (114.9)	140
151-01998	RCC30LM12SS	0.76 (19.4)	1.42 (36.0)	100.0 (445.0)	2.96 (75.2)	0.510 (12.95)		1.37 (34.9)	4.52 (114.9)	140
151-01999	RCC90SM6SS	0.76 (19.4)	1.42 (36.0)	100.0 (445.0)	1.57 (39.9)	0.256 (6.50)	90° Short	1.37 (34.9)	3.99 (101.2)	160
151-02001	RCC90SM8SS	0.76 (19.4)	1.42 (36.0)	100.0 (445.0)	1.57 (39.9)	0.327 (8.31)		1.37 (34.9)	3.99 (101.2)	160
151-02002	RCC90SM10SS	0.76 (19.4)	1.42 (36.0)	100.0 (445.0)	1.57 (39.9)	0.405 (10.29)		1.37 (34.9)	3.99 (101.2)	160
151-02003	RCC90SM12SS	0.76 (19.4)	1.42 (36.0)	100.0 (445.0)	1.57 (39.9)	0.510 (12.95)		1.37 (34.9)	3.99 (101.2)	160
151-02004	RCC90LM6SS	0.76 (19.4)	1.42 (36.0)	100.0 (445.0)	1.57 (39.9)	0.256 (6.50)	90° Long	1.37 (34.9)	5.09 (129.2)	140
151-02005	RCC90LM8SS	0.76 (19.4)	1.42 (36.0)	100.0 (445.0)	1.57 (39.9)	0.327 (8.31)		1.37 (34.9)	5.09 (129.2)	140
151-02006	RCC90LM10SS	0.76 (19.4)	1.42 (36.0)	100.0 (445.0)	1.57 (39.9)	0.405 (10.29)		1.37 (34.9)	5.09 (129.2)	140
151-02007	RCC90LM12SS	0.76 (19.4)	1.42 (36.0)	100.0 (445.0)	1.57 (39.9)	0.510 (12.95)		1.37 (34.9)	5.09 (129.2)	140

Use Part No. for ordering and Type for specification purposes.

Bundling & Securing Solutions

Stainless Steel Ratchet P Clamp - Size D

Stainless Steel Ratchet P Clamp

For bundle diameters from 1³/₈" to 2"

The Ratchet P Clamp family offers versatility when managing wires, cables and hoses. The robust design and durable materials make it ideal for heavy duty applications, both indoors and out. The one-piece adjustable clamp can be closed by hand to the desired diameter. The release feature provides easy and nondestructive removal of cables by simply using a flat head screwdriver. This nondestructive release allows the clamp to be reused without removing or replacing any bolts or screws. The Ratchet P Clamp is offered in four sizes and in multiple mounting configurations.

Features and Benefits

- One-piece ratchet closure design allows for easy installation during pre- or final assembly.
- Four sizes and multiple configurations handle a wide range of diameters and applications, reducing part inventory.
- Clamp interior is designed to guide and center bundle to reduce pinching.
- Easy release feature allows for quick adjustments and maintenance.
- Impact modified, heat and UV stabilized PA66 provides long-term durability, indoors and out.
- Steel mounting plate tolerates high torque mounting and is treated to resist chemicals and salt spray.



MATERIAL	Polyamide 6.6 high impact modified, heat and UV stabilized (PA66HIRHSUV)
Operating Temperature	-40°F to +257°F (-40°C to +125°C)
Flammability	UL94 HB

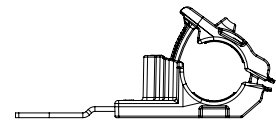
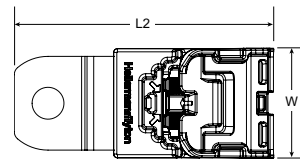

PART NO.	Type	Bundle Diameter Min.	Bundle Diameter Max.	Minimum Tensile Strength	Mounting Hole Centers	Mounting Hole Diameter D	Angle/Length	Width W	Length L2	Pkg. Qty.
		in. (mm)	in. (mm)	lbs. (N)	in. (mm)	in. (mm)		in. (mm)	in. (mm)	
151-02008	RCD180SM6SS	1.42 (36.0)	2.00 (51.0)	100.0 (445.0)	2.76 (70.0)	0.256 (6.50)	180° Short	1.37 (34.9)	4.55 (115.5)	160
151-02009	RCD180SM8SS	1.42 (36.0)	2.00 (51.0)	100.0 (445.0)	2.76 (70.0)	0.327 (8.31)		1.37 (34.9)	4.55 (115.5)	160
151-02010	RCD180SM10SS	1.42 (36.0)	2.00 (51.0)	100.0 (445.0)	2.76 (70.0)	0.405 (10.29)		1.37 (34.9)	4.55 (115.5)	160
151-02011	RCD180SM12SS	1.42 (36.0)	2.00 (51.0)	100.0 (445.0)	2.76 (70.0)	0.510 (12.95)		1.37 (34.9)	4.55 (115.5)	160
151-02012	RCD180MM6SS	1.42 (36.0)	2.00 (51.0)	100.0 (445.0)	3.62 (92.0)	0.256 (6.50)	180° Medium	1.37 (34.9)	5.41 (137.5)	140
151-02013	RCD180MM8SS	1.42 (36.0)	2.00 (51.0)	100.0 (445.0)	3.62 (92.0)	0.327 (8.31)		1.37 (34.9)	5.41 (137.5)	140
151-02014	RCD180MM10SS	1.42 (36.0)	2.00 (51.0)	100.0 (445.0)	3.62 (92.0)	0.405 (10.29)		1.37 (34.9)	5.41 (137.5)	140
151-02015	RCD180MM12SS	1.42 (36.0)	2.00 (51.0)	100.0 (445.0)	3.62 (92.0)	0.510 (12.95)		1.37 (34.9)	5.41 (137.5)	140
151-02016	RCD180LM6SS	1.42 (36.0)	2.00 (51.0)	100.0 (445.0)	4.76 (121.0)	0.256 (6.50)	180° Long	1.37 (34.9)	6.56 (166.5)	140
151-02017	RCD180LM8SS	1.42 (36.0)	2.00 (51.0)	100.0 (445.0)	4.76 (121.0)	0.327 (8.31)		1.37 (34.9)	6.56 (166.5)	140
151-02018	RCD180LM10SS	1.42 (36.0)	2.00 (51.0)	100.0 (445.0)	4.76 (121.0)	0.405 (10.29)		1.37 (34.9)	6.56 (166.5)	140
151-02019	RCD180LM12SS	1.42 (36.0)	2.00 (51.0)	100.0 (445.0)	4.76 (121.0)	0.510 (12.95)		1.37 (34.9)	6.56 (166.5)	140
151-02020	RCD15SM6SS	1.42 (36.0)	2.00 (51.0)	100.0 (445.0)	2.72 (69.1)	0.256 (6.50)	15° Short	1.37 (34.9)	4.56 (115.9)	160
151-02021	RCD15SM8SS	1.42 (36.0)	2.00 (51.0)	100.0 (445.0)	2.72 (69.1)	0.327 (8.31)		1.37 (34.9)	4.56 (115.9)	160
151-02022	RCD15SM10SS	1.42 (36.0)	2.00 (51.0)	100.0 (445.0)	2.72 (69.1)	0.405 (10.29)		1.37 (34.9)	4.56 (115.9)	160
151-02023	RCD15SM12SS	1.42 (36.0)	2.00 (51.0)	100.0 (445.0)	2.72 (69.1)	0.510 (12.95)		1.37 (34.9)	4.56 (115.9)	160
151-02024	RCD30SM6SS	1.42 (36.0)	2.00 (51.0)	100.0 (445.0)	2.20 (55.9)	0.256 (6.50)	30° Short	1.37 (34.9)	4.03 (102.4)	160
151-02025	RCD30SM8SS	1.42 (36.0)	2.00 (51.0)	100.0 (445.0)	2.20 (55.9)	0.327 (8.31)		1.37 (34.9)	4.03 (102.4)	160
151-02026	RCD30SM10SS	1.42 (36.0)	2.00 (51.0)	100.0 (445.0)	2.20 (55.9)	0.405 (10.29)		1.37 (34.9)	4.03 (102.4)	160
151-02027	RCD30SM12SS	1.42 (36.0)	2.00 (51.0)	100.0 (445.0)	2.20 (55.9)	0.510 (12.95)		1.37 (34.9)	4.03 (102.4)	160
151-02028	RCD30LM6SS	1.42 (36.0)	2.00 (51.0)	100.0 (445.0)	3.17 (80.5)	0.256 (6.50)	30° Long	1.37 (34.9)	5.00 (127.0)	140
151-02029	RCD30LM8SS	1.42 (36.0)	2.00 (51.0)	100.0 (445.0)	3.17 (80.5)	0.327 (8.31)		1.37 (34.9)	5.00 (127.0)	140
151-02030	RCD30LM10SS	1.42 (36.0)	2.00 (51.0)	100.0 (445.0)	3.17 (80.5)	0.405 (10.29)		1.37 (34.9)	5.00 (127.0)	140
151-02031	RCD30LM12SS	1.42 (36.0)	2.00 (51.0)	100.0 (445.0)	3.17 (80.5)	0.510 (12.95)		1.37 (34.9)	5.00 (127.0)	140
151-02032	RCD90SM6SS	1.42 (36.0)	2.00 (51.0)	100.0 (445.0)	1.67 (42.4)	0.256 (6.50)	90° Short	1.37 (34.9)	3.49 (88.7)	160
151-02033	RCD90SM8SS	1.42 (36.0)	2.00 (51.0)	100.0 (445.0)	1.67 (42.4)	0.327 (8.31)		1.37 (34.9)	3.49 (88.7)	160
151-02034	RCD90SM10SS	1.42 (36.0)	2.00 (51.0)	100.0 (445.0)	1.67 (42.4)	0.405 (10.29)		1.37 (34.9)	3.49 (88.7)	160
151-02035	RCD90SM12SS	1.42 (36.0)	2.00 (51.0)	100.0 (445.0)	1.67 (42.4)	0.510 (12.95)		1.37 (34.9)	3.49 (88.7)	160
151-02036	RCD90LM6SS	1.42 (36.0)	2.00 (51.0)	100.0 (445.0)	1.67 (42.4)	0.256 (6.50)	90° Long	1.37 (34.9)	4.59 (116.7)	140
151-02037	RCD90LM8SS	1.42 (36.0)	2.00 (51.0)	100.0 (445.0)	1.67 (42.4)	0.327 (8.31)		1.37 (34.9)	4.59 (116.7)	140
151-02038	RCD90LM10SS	1.42 (36.0)	2.00 (51.0)	100.0 (445.0)	1.67 (42.4)	0.405 (10.29)		1.37 (34.9)	4.59 (116.7)	140
151-02039	RCD90LM12SS	1.42 (36.0)	2.00 (51.0)	100.0 (445.0)	1.67 (42.4)	0.510 (12.95)		1.37 (34.9)	4.59 (116.7)	140

Use Part No. for ordering and Type for specification purposes.

Ratchet P Clamp Accessories

Tension Tab

The Ratchet P Clamp family offers optional accessories for different user needs. The Tension Tab provides a specified tension when clamping around the bundle when used with the EVO Series hand tools. Our soft inserts deliver an additional level of protection for sensitive bundles or high vibration applications.

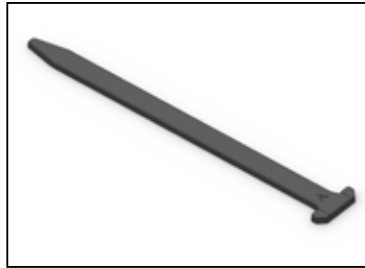

Features and Benefits

- For pre-determined clamp pressure, a tension tab is available for use with our EVO series hand tools.
- Soft material inserts are available for sensitive bundles.
- Soft material inserts eliminate the need to add grommets or dipping metal P clamps in PVC to make them less abrasive
- Soft material inserts snap precisely into the body of the clamp to provide an enhanced level of protection for applications with movement, high vibration or soft cable bundle.

MATERIAL	Polyamide 6.6 high impact modified, heat and UV stabilized (PA66HIRHSUV)
Operating Temperature	-40°F to +221°F (-40°C to +105°C)
Flammability	UL94 HB

MATERIAL	Thermoplastic Elastomer (TPE)
Operating Temperature	-40°F to +194°F (-40°C to +90°C)
Flammability	UL94 HB



PART NO.	Type	Description	Pkg. Qty.
151-01529	RCTT	Ratchet P Clamp Tension Tab, PA66HIRHSUV, 100/bag	100
151-01530*	RCINSERTA	Ratchet P Clamp Size A Soft Insert, Thermoplastic Elastomer, 100/bag	100
151-01531*	RCINSERTB	Ratchet P Clamp Size B Soft Insert, Thermoplastic Elastomer, 100/bag	100
151-01532*	RCINSERTC	Ratchet P Clamp Size C Soft Insert, Thermoplastic Elastomer, 100/bag	100
151-01533*	RCINSERTD	Ratchet P Clamp Size D Soft Insert, Thermoplastic Elastomer, 100/bag	100

Use Part No. for ordering and Type for specification purposes. Note: Using Soft Inserts will reduce clamp diameter range; please test in application to ensure the proper fit.
* These products are UL listed in the U.S. and Canada.

Ratchet P Clamp

Ratchet P Clamp Convenience Packs

The Ratchet P Clamp family offers versatility when managing wires, cables and hoses. The robust design and durable materials make it ideal for heavy duty applications, both indoors and out. The one-piece adjustable clamp can be closed by hand to the desired diameter. The release feature provides easy and nondestructive removal of cables by simply using a flat head screwdriver. This nondestructive release allows the clamp to be reused without removing or replacing any bolts or screws. The Ratchet P Clamp is offered in four sizes and in multiple mounting configurations.



Features and Benefits

- One-piece ratchet closure design allows for easy installation during pre- or final assembly.
- Four sizes and multiple configurations handle a wide range of diameters and applications, reducing part inventory.
- Clamp interior is designed to guide and center bundle to reduce pinching.
- Easy release feature allows for quick adjustments and maintenance.
- Impact modified, heat and UV stabilized PA66 provides long-term durability, indoors and out.
- Steel mounting plate tolerates high torque mounting and is treated to resist chemicals and salt spray.



MATERIAL	Polyamide 6.6 high impact modified, heat and UV stabilized (PA66HIRHSUV)
Operating Temperature	-40°F to +257°F (-40°C to +125°C)
Flammability	UL94 HB

PART NO.	Type	Bundle Diameter Min.	Bundle Diameter Max.	Minimum Tensile Strength	Mounting Hole Centers	Mounting Hole Diameter D	Angle/Length	Width W	Length L2	Pkg. Qty.
		in. (mm)	in. (mm)	lbs. (N)	in. (mm)	in. (mm)		in. (mm)	in. (mm)	
151-01670*	RCA180SM6	0.24 (6.2)	0.54 (13.7)	100.0 (445.0)	1.99 (50.5)	0.256 (6.5)	180° Short	1.37 (34.9)	3.27 (83.1)	5
151-01671*	RCB180SM6	0.50 (12.7)	0.77 (19.5)	100.0 (445.0)	2.08 (52.8)	0.256 (6.5)		1.37 (34.9)	3.27 (83.1)	5
151-01672*	RCC180SM6	0.76 (19.4)	1.42 (36.0)	100.0 (445.0)	2.45 (62.3)	0.256 (6.5)		1.37 (34.9)	4.06 (103.0)	3
151-01673*	RCD180SM6	1.42 (36.0)	2.00 (51.0)	100.0 (445.0)	2.76 (70.0)	0.256 (6.5)		1.37 (34.9)	4.55 (115.5)	3

Use Part No. for ordering and Type for specification purposes.
* These products are UL listed in the U.S. and Canada.

**HellermannTyton North American
Corporate Headquarters**

7930 N. Faulkner Rd, PO Box 245017
Milwaukee, WI 53224-9517
Phone: (414) 355-1130, (800) 537-1512
Fax: (414) 355-7341, (800) 848-9866
email: corp@htamericas.com
www.hellermann.tyton.com

TS16949, ISO 9001, and ISO14001 certified

HellermannTyton Canada

Unit #4, 205 Industrial Parkway North
Aurora, Ontario L4G 4C4 Canada
Phone: (800) 661-2461
Fax: (800) 390-3904
email: sales@hellermanntyton.ca

HellermannTyton Mexico

Anillo Periferico Sur 7980 Edificio 6A
Parque Industrial Tecnologico II
Santa María Tequepexpan
Tlaquepaque, Jalisco, Mexico 45601
Phone: 011-52-33-3-133-9880
Fax: 011-52-33-3-133-9861
email: info@htamericas.com.mx

ISO 9001 certified

Warranty Policy

HellermannTyton products are warranted to be free from defects in material and workmanship at the time sold by us; but our obligation under this warranty and that of the seller is limited to the replacement of the product, and neither we nor the seller are bound by any other warranty, expressed, implied or statutory. Under no circumstances are we or the seller liable for any loss, damage, expenses or consequential damages of any kind arising out of the use or inability to use these products. All are sold with the understanding that the user will test them in actual use and determine their adaptability for the intended uses.



HellermannTyton

© HellermannTyton Corporation
LITPD310 Rev 4, 10.2018