

OPERATION AND MAINTENANCE MANUAL

DKS-65

**Precise dosing and fresh
On Demand**



Devoted to perfect grinding



Notification of CEE requirements:

D.I.P. IMPEX SRL, located at 287 Theodor Pallady Blvd., 032258 Bucharest, Romania, manufactures the DKS-65 On demand Grinder in compliance to CEE requirements:

N73/23 (low tension)

N89/392 (machines)

The DKS-65 On demand Grinder has been tested in accordance the following norms:

- **EN 60 335-1**
- **EN 55011**
- **EN 61000-3-2**
- **IEC/EN 61000-4-2, -4, -5, -6, -8, -9, -11, -29 (safety regulations for domestic or similar use)**
- **EN 335/264 (2nd part: safety regulations for professional kitchen instruments).**

D.I.P. IMPEX SRL
Technical office
Bucharest, 13/07/2013



GENERAL WARNINGS

- Read this manual before using the appliance as it contains important instructions for the safety, operation and maintenance of the appliance.
- Before plugging in the appliance, make sure that voltage and frequency values of the power supply correspond to the rating plate.
- The wall socket must be fitted with an earth contact and a 10A fuse.
- Before performing any work on the appliance, including cleaning or maintenance, disconnect it from the power supply.
- Turning off the appliance by using its master switch does not assure the same conditions of safety.
- The manufacturer cannot be held responsible for bodily injury or property damage if the above warnings are not respected and the warranty will be void.

PARTICULAR WARNINGS

- Do not tamper with the appliance, for maintenance or repair contact an authorized service center.
- Do not pull the power cable in order to unplug the appliance from the socket.
- This appliance has been designed solely for grinding coffee beans.
- Place the appliance at minimum of 5 cm from the wall to allow proper ventilation.
- Keep the appliance at a safe distance from water sources.
- Never leave the machine unintended, keep it out of the reach of children or people with handicap.
- Do not switch on an appliance that looks damaged.
- Use only original accessories and parts.
- To avoid the danger of fire, never cover the appliance.
- Unplug the appliance from the mains when it is not in use.
- Let the appliance cool down before moving it.
- Be aware that the grinding blades may continue rotating for a short period of time after the appliance is switched off.
- Do not let liquids of any kind come in contact with the internal or external parts of the appliance.
- Never pour ground coffee in the hopper, the grinder is designed only for coffee beans.
- Do not touch the appliance with damp or wet hands/feet.
- THE HOPPER MUST BE FASTENED TO THE GRINDER BY MEANS OF THE RELEVANT SCREW which must be inserted in the threaded hole located on the coffee grinding Adjustment disk (fig. 1).
- The manufacturer cannot be held responsible for bodily injury or property damage if the above warnings are not respected and the warranty will be void.

ATTENTION: Moving parts.

Introduction:

Since immemorial time, making coffee has been an art. Precise rules have to be followed in order to succeed. The formula to get a perfect cup of express coffee depends largely on the quality of the coffee grinding machine. In order to achieve an indisputable quality and a breathtaking taste it is mandatory to follow three rules:

1. A precise mixture
2. The correct use of equipment.
3. A thoroughly trained person.

To enjoy a good cup of coffee, unlike what you believe, it is not enough just to choose a particular coffee mixture. A skilled operator, who follows the proper preparation procedures and uses the machinery in an appropriated manner, contributes decisively at the creation of a masterpiece.

This is why professionals give so much importance to their espresso and grinder machines. Being familiar with his machines, keeping them in perfect working conditions and using them to the best of their ability, are the skills that belong to a true coffee master.

The quality of a good espresso coffee is the result of a series of operations, grinding having an important role. The grinder, therefore, is for the operator one of the most important tool, whose structure must meet certain characteristics such as: strength, durability and functionality.

Dimensions DKS-65

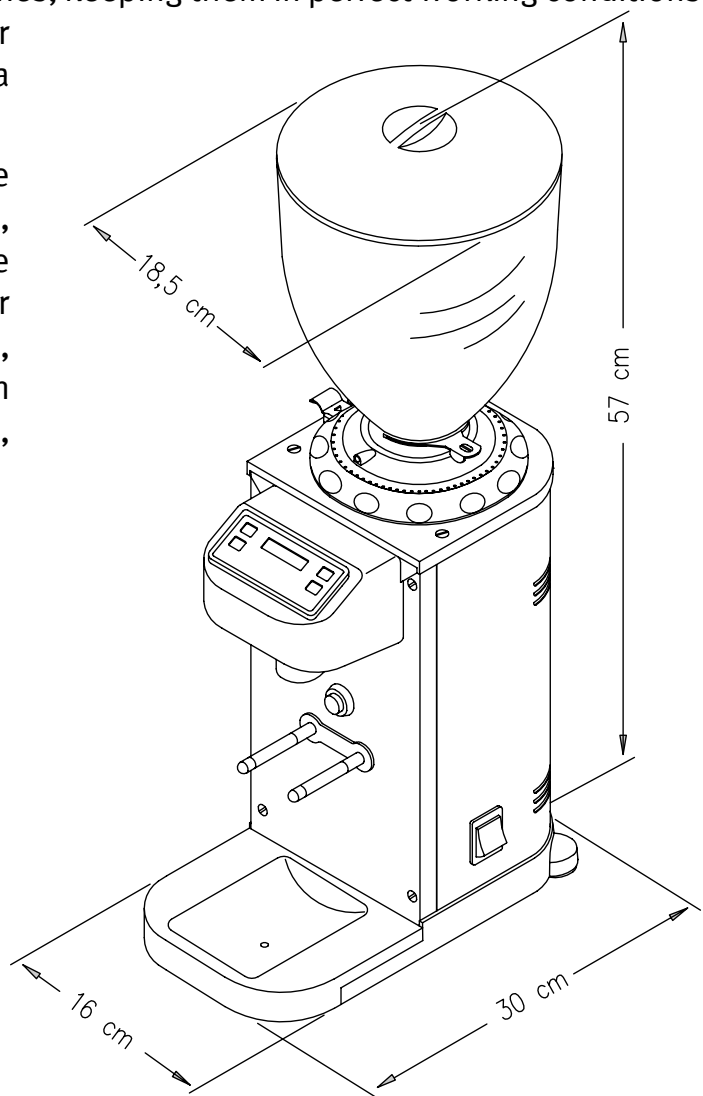

Components Description

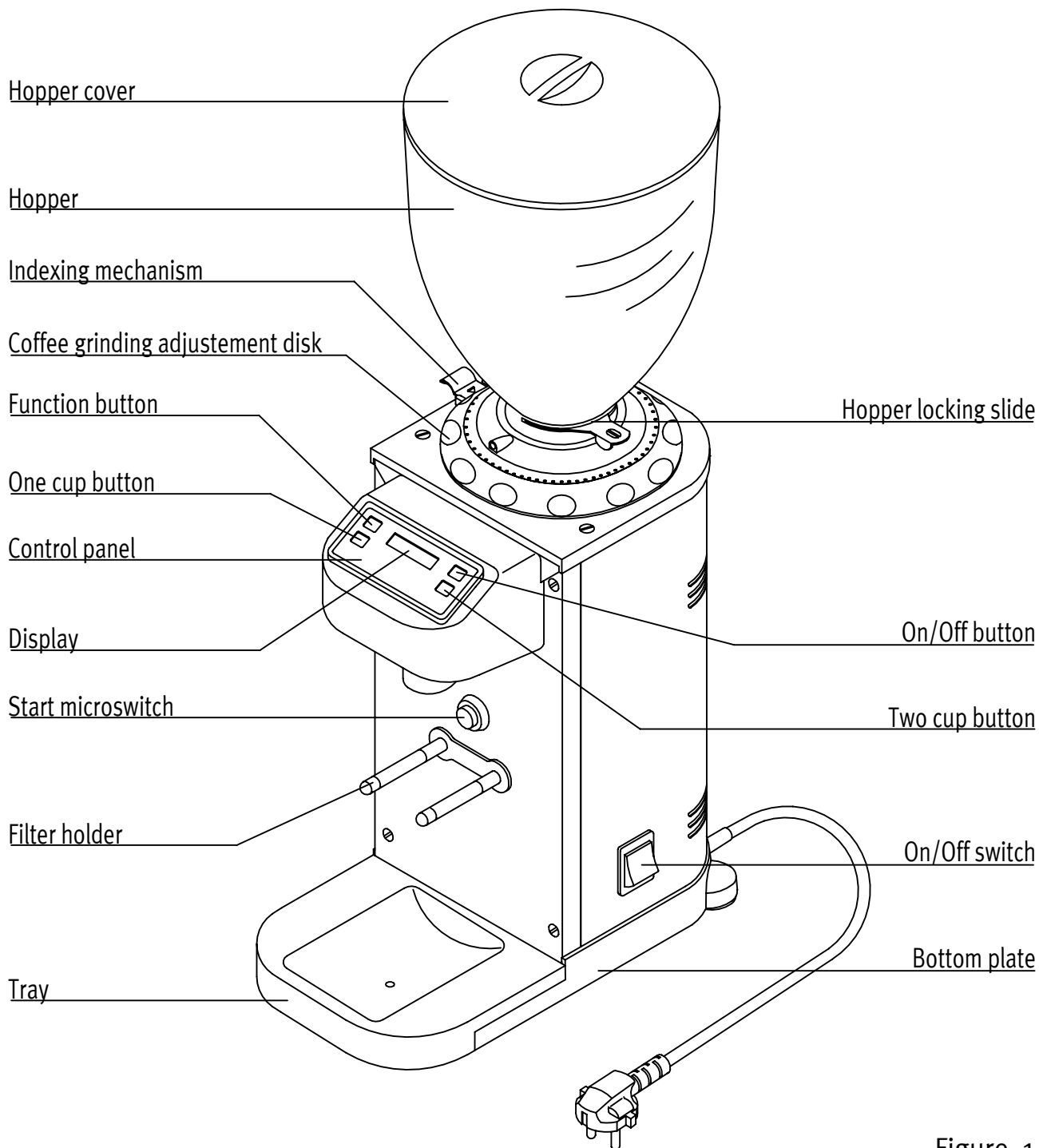

Figure. 1

Unpacking the DKS-65 On demand Grinder:

When open the package, carefully check the equipment for any possible damage. If you have any doubt, do not use it and contact a qualified technician. If you have to ship back the equipment, this must be done in the original package otherwise the warranty is void.

Warning: packing materials can be hazardous to children.

Packaging Disposal:

Dispose the packaging materials according to local laws and regulations. If you decide not to use the appliance any more, disconnect it from the mains, cut the power cable at the point where it comes out of the appliance. Contact a specialized recycling company.

Proper Use:

This appliance has been designed solely for grinding coffee beans. Any other use is considered to be improper, and consequently hazardous. The manufacturer cannot be held responsible for any damage as a result of improper or incorrect use.

Do not use the appliance for grinding other types of food, or anything else.

ALL COFFEE GRINDERS MANUFACTURED BY OUR COMPANY ARE DESIGNED TO BE USED BY SKILLED PERSONNEL, ONLY FOR PROFESSIONAL USE AND NOT FOR HOUSE-HOLD USE.

The user must be an adult. Do not allow children or people with handicap to use the appliance.

Installation and wiring:

The appliance must be installed by authorized personnel only. Incorrect installation may result in personal injury or property damage, for which the manufacturer cannot be held responsible.

- The appliance must be placed on a stable and flat surface.
- Do not install the appliance in rooms where water jets are used for cleaning.
- Before plugging in the appliance, make sure that the voltage and frequency values of the supply mains correspond to the rating plate.
- It is essential to ensure that the socket power supply is suitable for the appliance's power consumption, as is indicated on the rating plate, and the wall socket is current fluctuation protected.
- The wall socket must be fitted with an efficient earth contact (grounded). If in doubt, have it checked by an licensed technician.
- Do not use extension cables, **plug adapters, multiple sockets or makeshift connections.**

Operating instructions:

Preliminary operations

Check that the hopper is positioned correctly on the appliance and secured to the Coffee grinding **Adjustment disk** with the relevant screw (fig.1). Close the Hopper locking slide (fig. 1) and fill the hopper with coffee beans. Open the slide to allow the coffee beans to fall in the grinding chamber.

Adjusting the grind

Your new DKS-65 is delivered from the factory at a preset grinding of minimum fineness. Use the **Adjustment disk** located under the hopper (fig. 1), for obtaining a finer or coarser grinding result.

The Adjustment disk is functional only when the Indexing mechanism (fig. 1) is hold down.

For coarser grinding turn the **Adjustment disk** anti-clockwise, to finer grinding turn the disk clockwise.

The **Adjustment disk** is blocked at the chosen position by releasing the **Indexing mechanism**.

Grind small amounts of coffee in order to determine the optimal degree of fineness.

A simple method to verify the grinding setting, is at the espresso machine. If the coffee comes out of the espresso coffee machine very quickly, it means that the coffee is grounded to coarse. If it comes out too slowly, it means that the coffee is grounded to fine.

ADJUSTING GRINDING

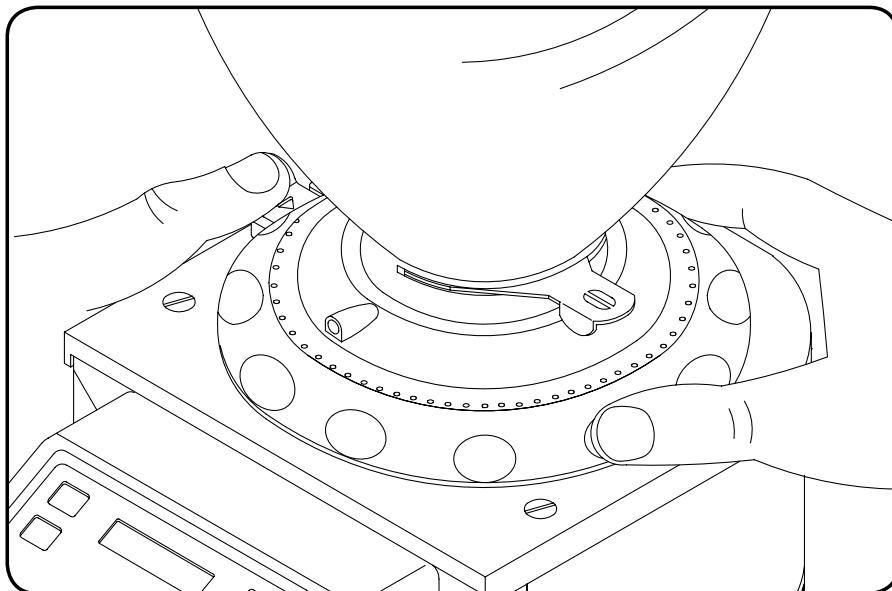

Figure. 2

Safety protection:

THERMAL OVERLOAD PROTECTION

The appliance's motor is protected against overheating by a thermal protection which, when tripped, cuts off the motor's power supply. If the protection trips as a result of anomalous operation, such as jamming the grinding blades, the appliance must be turned off using the ON/OFF switch (fig.1), DISCONNECTED FROM THE MAINS, AND CONTACT A LICENSED TECHNICIAN.

Noise level:

The maximum noise emission of this coffee grinder is measured in UNI EN ISO 3741 reverberating chamber in compliance with the EN 60704-1 regulations and complies with the EN 60704-1:1998 and EN 607043:1996 regulations.

The daily noise exposure of a worker, due only to an appliance's limited operation of 240 minutes per 8 hours, is 78 dB (A), according to ED 89/188/ECC and ED 200311/EEC. Therefore, during the daily operation, measures must be taken in order to prevent any injury from noise exposure (article 3-8 of ED 2003/10/EEC).

Maintenance:

It is essential to check the status of the cable and plug periodically.

IN THE EVENT OF DAMAGED SUPPLY CABLE OR PLUG, CALL IN A LICENSED TECHNICIAN TO REPLACE THEM. THIS WILL PREVENT ANY FUTURE DAMAGE OF THE APPLIANCE.

It is recommended to use original replacement parts to assure the proper working conditions of the appliance. A licensed technician must perform periodic maintenance, including detailed inspection of those components subject to wear.

The status of the grinding blades must be checked periodically. Keeping them in an excellent condition, assures better productivity and cooler coffee outcome.

Cleaning the appliance:

THE APPLIANCE CANNOT BE CLEANED USING WATER JETS.

THOROUGH CLEANING MUST BE PERFORMED PERIODICALLY BY A LICENSED TECHNICIAN.

Use perfectly clean, disinfected cloths or brushes for cleaning.

Do not use abrasive products for cleaning in order to prevent damaging the shiny parts.

NEVER PERFORM ANY MAINTENANCE OR CLEANING OF THE APPLIANCE WHILE IT IS
CONNECTED TO THE MAINS

Hopper:

Wash the hopper once it has been removed from the appliance, using neutral soap and water, rinse abundantly with warm water and dry thoroughly. It is recommend to clean the hopper periodically.

Grinding Disk Replacement:

In order to change the grinding disks of the DKS-65 please follow the steps found below:

- Close the **Hopper locking slide** (fig.1).
- Start the machine until you stop hearing the sound of coffee beans grinded.
 - **Unplug the machine.**
- Remove the hopper and check that no coffee leftovers are found in the grinding chamber.
- By keeping the **Indexing mechanism** pressed at all times, turn the **Coffee grinding adjustment disk** (fig.1) anti-clockwise until it is fully released.
- Unscrew the lower disk found in the grinding chamber and the upper disk found on the **Coffee grinding adjustment disk**.
- Clean thoroughly the surface where both disks were rested.
- Place the new grinding disks in their former position and fasten them tightly with their screws.
- By keeping the **Indexing mechanism** pressed at all times, turn the **Coffee grinding adjustment disk** (fig.1) clockwise until it is tightly fastened.
- Check that the Coffee grinding adjustment disk indicator (fig.1) is close to 0.
- By keeping the **Indexing mechanism** pressed, turn the **Coffee grinding adjustment disk** (fig.1) anti-clock wise, until its indicator is indexed to 1.
 - **Connect the machine to the mains.**
 - **Set the working mode to Manual (page 13).**
- Start the machine by pressing the start micro switch (fig. 1), **JUST ONCE**. If you hear the sound of metal scraping turn the **Coffee grinding adjustment disk** (fig.1) anti-clock wise until its indicator is indexed to 2.
- Start the machine again by pressing the start micro switch (fig.1), **JUST ONCE** to make sure that you do not hear any sound of metal scraping.
- Set the working mode to your preference. **Auto, Auto Plus** or **Manual** (page 13).
- Adjust the grinding fineness at the optimal setting (page 7).

Display and functions

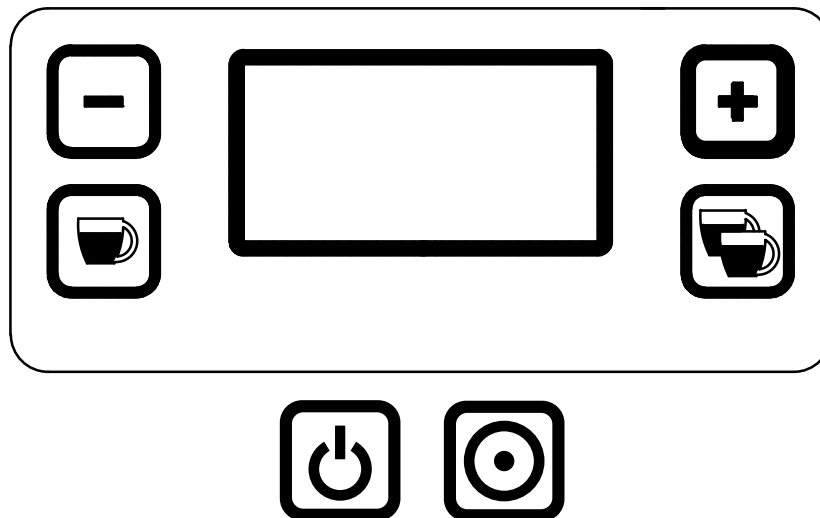

1. Starting the machine:

Flick the main switch:



The company's logo appears



Few seconds after:

The Single cup menu appears.
Auto grinding mode as default.

To shift between grinding modes see *Chapter 6*

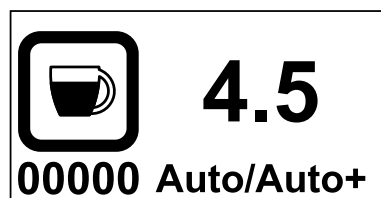

00000 = Partial doses counter, can be reset periodically (*see Chapter 7*)

4.5 = Nr of seconds per dose

Auto = Grinding mode, to change (*see Chapter 8*)

2. Choosing between Single or Double Dose

a. Single shot (Default)

Press  To choose for single

The  **4.5** pictogram appears
00000 Auto/Auto+

b. Double shot



Press  To choose for double

The **8.5**  pictogram appears
Auto/Auto+ 00000

3. Setting the grinding time

a. When single

When machine is set for single doze, press:

 or  To increase or decrease the grinding time

The Grinding time increments with 0.1 sec. ex 4.5, 4.6, 4.7, 4.8.

 **4.8**
00000 Auto/Auto+

b. When double

When machine is set for Double doze, press:

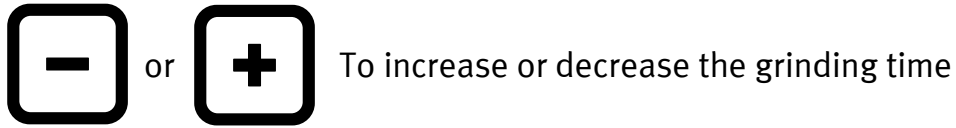

The Grinding time increments with 0.1 sec. ex 8.5, 8.6, 8.7, 8.8

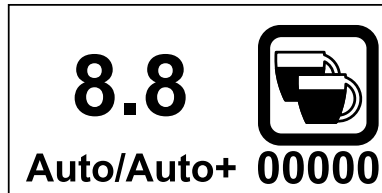

4. Grinding

a. When single

When the dose switch  is hit shortly the machine starts grinding, *Auto/Auto+* disappears and:

- A. A bar appears under the time index, i.e. 4.5, which is filled, during grinding time.**
- B. Nr. of seconds decreases from 4.5 to 0**

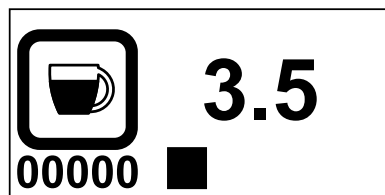

When the grinding finishes the bar disappears, *Auto/Auto+* appears

The Partial doses counter, *0000*, increments with 1

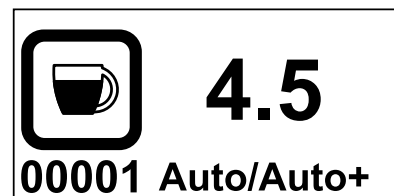

b. When Double

When the dose switch  is hit shortly the machine starts grinding, *Auto/Auto+* disappears and:

- A. A bar appears under the time index, i.e. 8.5, which is filled, during grinding time.
- B. Nr. of seconds decreases from 8.5 to 0

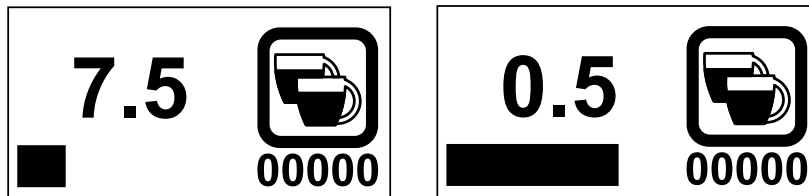

When grinding finishes the bar disappears, *Auto/Auto+* appears

The Partial doses counter, 0000, increments with 1

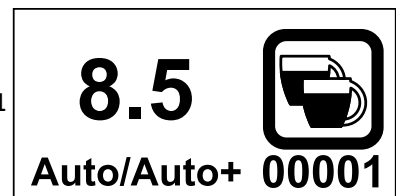

5. Grinding Modes:



When the grinding switch  is struck shortly, the machine grinds for the preset time.

Ex: 4.5 sec for single / 8.5 sec for double

After each cycle the Partial doses counter increments with 1.

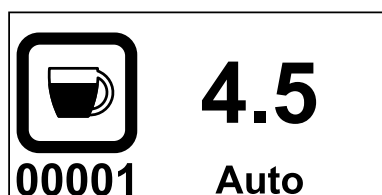

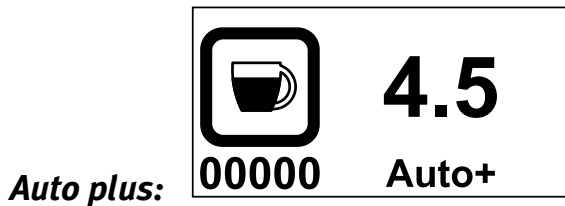

When the grinding switch  is struck shortly:

The machine grinds for the preset time. When the cycle ends, for 5 seconds the word Manual appears.

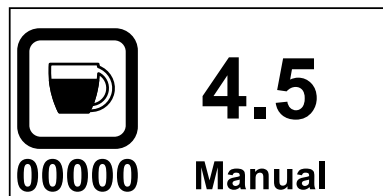

During these 5 seconds:

The grinding switch activates grinding for as long as it is kept pressed.

Every time the switch is pressed those 5 seconds are reset.

After 5 sec of not touching the grinding switch the display turns to

Auto+ After each cycle the counter increments with 1.

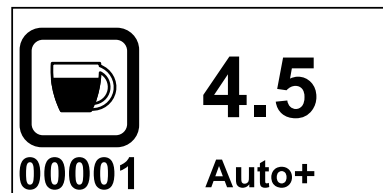

When the grinding switch  is struck the machine runs for as long as the switch is kept pressed, the seconds counter starts with **0.0**:

During grinding the number of seconds of motor functioning increment with 0.1

Ex.: 0.1, 0.2, 0.3, etc, 3.1, 3.2, 3.3, 3.4 etc.



In this mode the Partial doses counter does not increment.

6. Locking Grinding time

In order to avoid the change of grinding time during daily operation the grinding time has to be locked.

A. To lock the grinding time press for 5 seconds simultaneously:

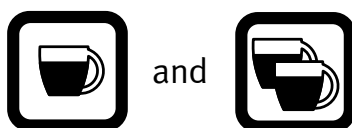

The following pictogram appears:

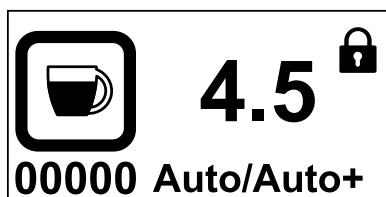

or

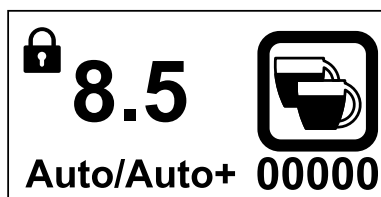

During lock, if the operator presses

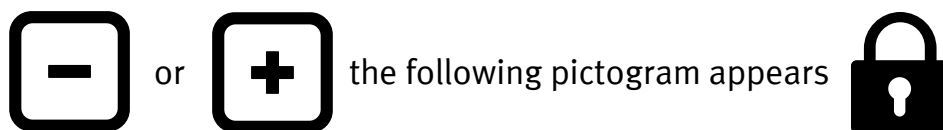

B. To unlock the grinding time press for 5 seconds simultaneously:



The following pictogram appears

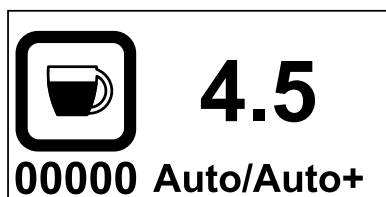

or

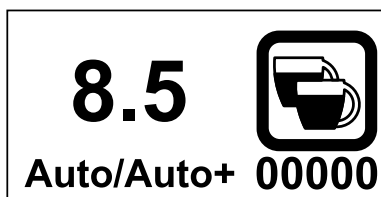

Now the operator can change the grinding time

7. Resetting Partial Doses

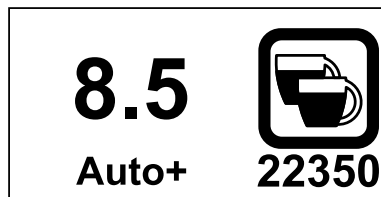
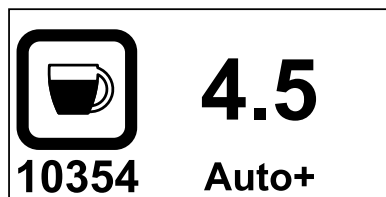

To reset the partial doses counter press for 5 seconds simultaneously:







To prevent from changing the selected grinding time, lock before.
(see Chapter 6)

The following pictogram appears



For the next 10 seconds the partial doses counters can be reset

Press simultaneously  and  for 7 more seconds. Both counters are reset.

After releasing the  and  the machine turns to single or double dose from where it was left:

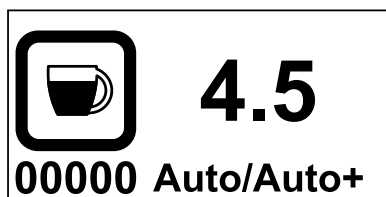

or

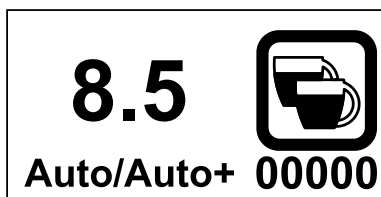

The number of partial doses shifts to 00000.

8. Setting Grinding mode

Switch OFF the machine from the main switch



With both



and



pressed, flick the main switch



Keep both



and



pressed until the following pictogram

appears

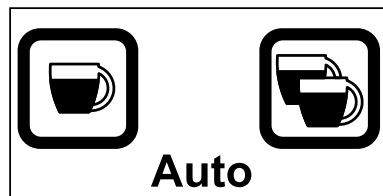

You have 5 seconds to shift between modes by Pressing



or

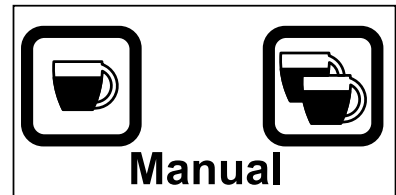
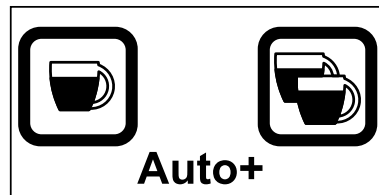
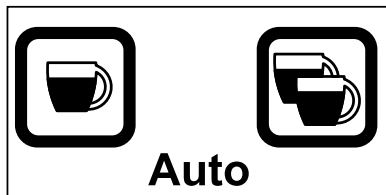

Every time you press



or



these 5 secs are refreshed

After 5 secs of no action, the grinding mode is saved to your selection:

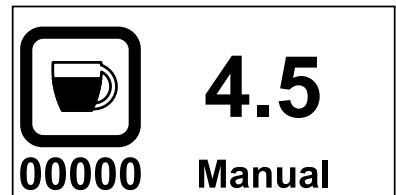
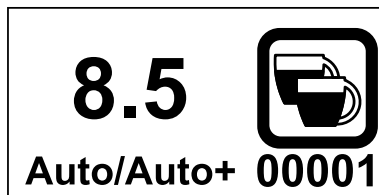
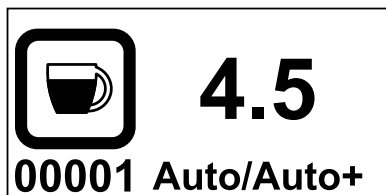

9. Viewing the total doses

When machine is in normal operation

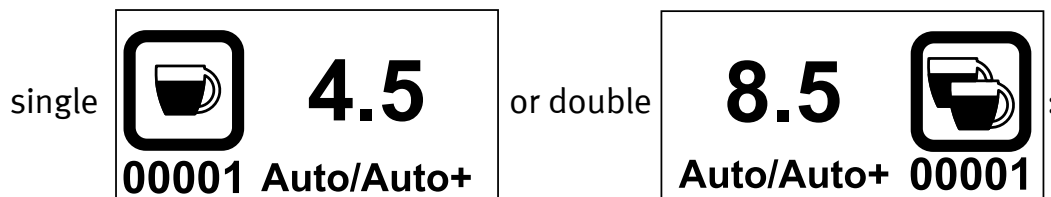

Pres the single  or  double for 5 seconds:

The following pictogram appears

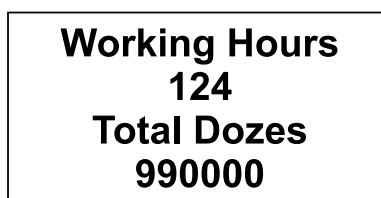

Working Hours represents the total Nr. of hours that motor run since fabrication

Total doses represent, the total number of shots grinded since fabrication.

Att: The number of sigle doses is multiplied with 1

The number of double doses is multiplied by 2

Then, they are added together

3 secs after releasing, the machine turns to prior working mode:



ESPRESSO GRINDERS

DKS-65 On Demand grinder is an innovative machine. With devotion to the needs of Coffee shops, Hotels and Baristas, **DKS-65** delivers each coffee portion, freshly grounded on demand

- Constant and cool grinding which assures crema and coffee aroma
- Fresh on demand coffee grinding for every dose delivered
- No coffee decay due to pre-grinding
- Precise dosing level by electronic control, to assure constant shots
- Single and double dose selector, individually adjustable
- Simple and precise grinding adjustment
- Daily Track counter for both single and double doses grounded
- Easy slide stop lid
- 2-Step cleaning 4-Step maintaining system

Technical information

DKS-65

Voltage / Frequency	220-230V/50-60Hz 110-120V/60Hz
Motor power	0.65 kW
Average grinding capacity*	3.2 g/sec
Hopper capacity	1300 g
Grinding disc diameter Ø	64 mm
Net weight	9 kg
Dimensions (w x d x h), mm	160 x 300 x 570
Standard colour	Black

*The output can vary according to coffee beans type and roasting method

Additional electrical specifications are available upon request

Special colours can be ordered, please consult with our commercial dept.



HEAD OFFICE:

287 Theodor Pallady Blvd. 032258, Bucharest Romania

Phone: +40 21 345 11 06 • Fax: +40 21 345 11 07

www.dipgrinders.ro • office@dipgrinders.ro