



nuova
SIMONELLI[®]
espresso coffee machines



MUSICA

SERVICE MANUAL



MACHINE DESCRIPTION	
FIRST INSTALLATION AND PRELIMINARY OPERATIONS	
REMOVAL OF THE EXTERNAL SURFACE	
INFUSION UNIT	
HEATER	
HYDRAULIC CIRCUIT	
ELECTRIC COMPONENTS	
TROUBLESHOOTING	
DIAGRAMS	
MAINTENANCE CHECKING	
SPARE PART CATALOGUE	

INDEX

1. MACHINE DESCRIPTION	1.1
1.1 DESCRIPTION	1.2
1.2 KEYBOARD DESCRIPTION (Standard configuration)	1.3
1.3 SAFETY REGULATIONS	1.4
1.4 MACHINE IDENTIFICATION	1.7
1.5 TRANSPORT	1.8
1.5.1 HANDLING	1.8
2. FIRST INSTALLATION AND PRELIMINARY OPERATIONS	2.1
2.1 FIRST INSTALLATION	2.2
2.1.1 WEIGHT AND DIMENSIONS	2.2
2.1.2 CONNECTION TO THE WATER LINE AND DRAINAGE SYSTEM	2.3
2.1.3 TECHNICAL SPECIFICATIONS	2.4
2.1.4 CONNECTION TO THE POWER LINE	2.4
2.1.5 PROCEDURE OF FIRST INSTALLATION	2.5
2.2 ACCESSORIES BOX	2.7
2.2.1 FITTING THE FILTER HOLDER	2.7
2.3 COFFEE DOSE SETTING	2.8
3. REMOVAL OF THE EXTERNAL SURFACE	3.1
3.1 REMOVAL OF WATER TANK	3.2
3.2 REMOVAL OF THE CUP HOLDER SURFACE	3.3
3.3 REMOVAL OF THE SIDE PANELS	3.4
3.4 REMOVAL OF THE REAR PANEL	3.5
3.5 REMOVAL OF THE FRONT PANEL	3.6
3.6 REMOVAL OF KEYBOARD	3.8
4. INFUSION UNIT	4.1
4.1 REMOVAL OF SHOWER AND SEAL	4.2
4.2 COFFEE VALVE	4.3
4.3 EXPANSION VALVE	4.5
5. HEATER	5.1
5.1 EMPTYING THE HEATER	5.2
5.2 REMOVAL OF THE HEATER	5.4
5.3 HEATING ELEMENT AND HEAT PROTECTION	5.5
5.4 REPLACEMENT OF THE LEVEL GAUGE	5.6
5.5 ANTI-SUCTION VALVE	5.7
5.6 SAFETY VALVE	5.8
6. HYDRAULIC CIRCUIT	6.1
6.1 PUMP DISASSEMBLY	6.2
6.2 REPLACING THE COFFEE VALVE	6.4
6.3 FLOWMETER	6.6
6.4 HOT WATER VALVE	6.8
6.4.1 DISASSEMBLY OF HOT WATER NOZZLE	6.10
6.5 STEAM NOZZLE	6.10
6.6 WATER TANK	6.15
6.6.1 REPLACEMENT OF THE FLOAT	6.15
6.6.2 REMOVAL OF THE MAGNETIC SENSOR	6.16
6.6.3 REMOVAL OF THE TANK MICROSWITCH	6.16
6.7 REMOVAL OF THE PRESSURE SWITCH	6.17
7. ELECTRIC COMPONENTS	7.1
7.1 CONTROL UNIT	7.2
8. TROUBLESHOOTING	8.1
8.1 WATER LACK LIGHT	8.2
8.2 HEATING ELEMENT LIGHT	8.3
8.3 REMOVAL OF KEYBOARD	8.4
8.4 LIGHTS (LUX VERSIONS)	8.5
8.5 COFFEE DELIVERY	8.6
8.6 WATER DELIVERY	8.7
8.7 STEAM DELIVERY	8.8
8.8 HEATER	8.9
9. DIAGRAMS	9.1
9.1 HYDRAULIC DIAGRAM TANK VERSION	9.1
9.2 HYDRAULIC DIAGRAM DIRECT CONNECTION VERSION	9.2
9.3 WIRING DIAGRAM TANK VERSION	9.3
9.4 WIRING DIAGRAM DIRECT CONNECTION VERSION	9.4
10. MAINTENANCE CHECKING	10.1
10.1 DAILY MAINTENANCE	10.2
10.2 WEEKLY MAINTENANCE	10.2
10.3 YEARLY MAINTENANCE	10.3
10.4 BIENNIAL MAINTENANCE	10.4
11. SPARE PART CATALOGUE	11.1
11.1 CABINET PARTS	11.2
11.2 COMPLETE POURING UNIT	11.3
11.3 TANK FRAME COMPONENTS	11.4
11.4 DIRECT CONNECTION FRAME COMPONENTS	11.5
11.5 STEAM & HOT WATER VALVES PARTS	11.6
11.6 BOILER COMPONENTS	11.7
11.7 ELECTRICAL COMPONENTS	11.8

1. MACHINE DESCRIPTION



INDEX

1. MACHINE DESCRIPTION	1.1
1.1 DESCRIPTION.....	1.2
1.2 KEYBOARD DESCRIPTION (Standard configuration)	1.3
1.3 SAFETY REGULATIONS	1.4
1.4 MACHINE IDENTIFICATION	1.7
1.5 TRANSPORT	1.8
1.5.1 HANDLING	1.8

1.1 DESCRIPTION

Fig. 1

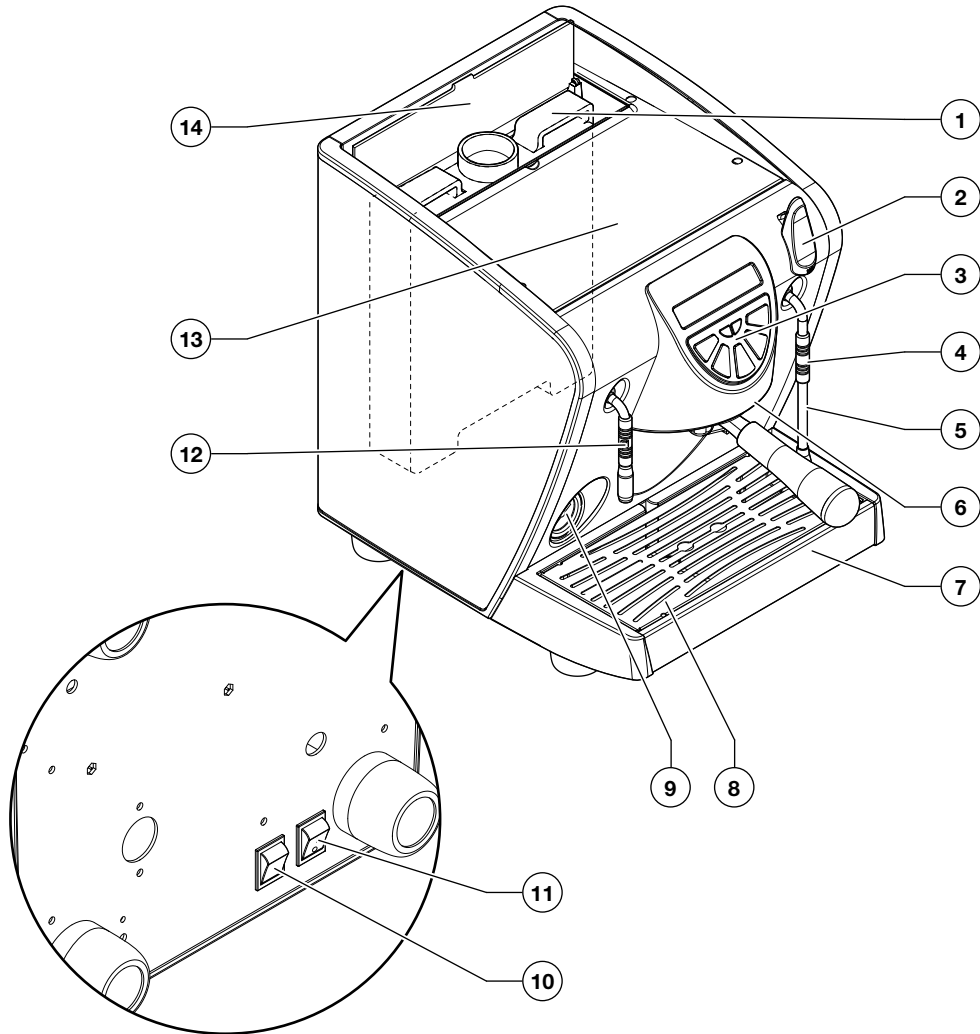

LEGEND

- 1 Water reservoir
- 2 Steam knob
- 3 Control panel
- 4 Insulating socket
- 5 Moveable steam nozzle
- 6 Delivery assembly attachment
- 7 Water drain tank
- 8 Cup support grill
- 9 Pressure gauge
- 10 Machine power switch
- 11 Light switch
- 12 Hot water dispenser wand
- 13 Cup warming shelf
- 14 Water reservoir hatch

1.2 KEYBOARD DESCRIPTION (Standard configuration)

Fig. 2



LEGEND

- 1 Boiler tank heating element indicator light
- 2 Machine on/off switch
- 3 2 coffee dispensing button
- 4 Continuous coffee dispensing button
- 5 1 coffee dispensing button
- 6 Hot water dispensing button
- 7 Water tank indicator light

1.3 SAFETY REGULATIONS

 The present manual is an integral and essential part of the product and is to be delivered to the user. Carefully read all warnings in the manual as they provide important information required to install, use and maintain the unit safely. Keep this manual in a safe place for further consultation.

 After having removed the packaging, make certain that the unit is not damaged in any way.
If you have any doubts, do not use the unit and contact a professionally qualified person. Always keep all packaging (plastic bags, polystyrene foam, nails, etc..) out of the reach of children as they are a potential source of danger and never loiter the environment with such materials.

 **RISK OF POLLUTION**

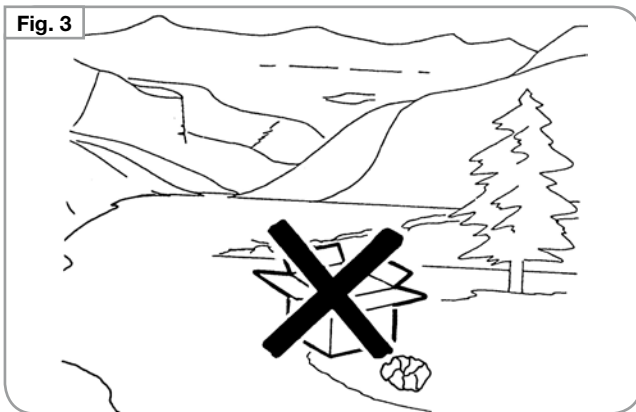

 The machine can be installed in staff kitchen areas in shops, offices and other working environments, farm houses by clients in hotels, motels and other residential type environments bed and breakfast type environments.





 Before turning on the unit make certain that the rating indicated on the label matches the available power supply. The label is located under the machine work base. Installation must be performed following the standards in force in the country where it is being installed and following the manufacturer's instructions. Only skilled personnel can install this unit.
The manufacturer cannot be held responsible for any damages incurred if the system is not grounded.
For electrical safety, this machine requires a ground system. Contact a technically certified electrician who must check that the line electrical capacity is adequate for the maximum capacity indicated on the unit label.

Fig. 4





 The electrician must also check that the line cables have adequate section to handle the power absorbed by the unit. Never use adapters, multiple jacks or extension cords. When such items prove absolutely necessary, call in a qualified electrician.

 When installing the device, it is necessary to use the parts and materials supplied with the device itself. Should it be necessary to use other parts, the installation engineer needs to check their suitability for use in contact with water for human consumption.

 The machine must be installed in compliance with the local health standards in force for plumbing systems. Therefore, contact an authorized plumber.

 The device needs to be supplied with water that is suitable for human consumption and compliant with the regulations in force in the place of installation. The installation engineer needs confirmation from the owner/manager of the system that the water complies with the requirements and standards stated above. The machine with water main connection must be installed using a new pipe furnished with the machine. Never use old pipings to connect the machine.

 This unit must only be used for the purposes described in the present manual. The manufacturer cannot be held responsible for any damages caused by improper, mistaken and unreasonable use.

 The appliance is not to be used by children or persons with reduced physical, sensory or mental capabilities, or lack of experience and knowledge, unless they have been given supervision or instruction. Children don't have to play with this appliance. Cleaning and maintenance don't have to be performed by unsupervised children.

 This appliance is for professional use only.

 The operating temperature must be within the range of [+5, +35]°C.

At the end of installation, the device is switched on and taken to rated operating conditions, leaving it in a state in which it is "ready for operation".

The device is then switched off and the whole hydraulic circuit is bled of the first lot of water in order to remove any initial impurities.

The device is then refilled and taken to rated operating conditions.

After reaching the "ready for operation" condition, the following dispensing operations are carried out:

- 100% of the coffee circuit through the coffee dispenser (for more than one dispenser, this is divided equally);
- 100% of the hot water circuit through the water dispenser (for more than one dispenser, this is divided equally);
- opening of each steam outlet for 1 minute.

At the end of installation, it is good practice to draw up a report of the operations.



WARNING

Before using the machine, read this manual in its entirety or, at the very least, read the safety and set up instructions.

There are some basic rules for the use of any electrical appliance.

In particular:

- never touch the unit with wet hands or feet;
- never use the unit with bare feet;
- never use extension cords in areas equipped with baths or showers;
- never pull on the power supply cord to unplug the unit;
- never leave the unit exposed to atmospheric agents (rain, direct sunlight, etc.);
- never let children, unauthorized personnel or anyone who has not read this manual operate the unit.

Fig. 5

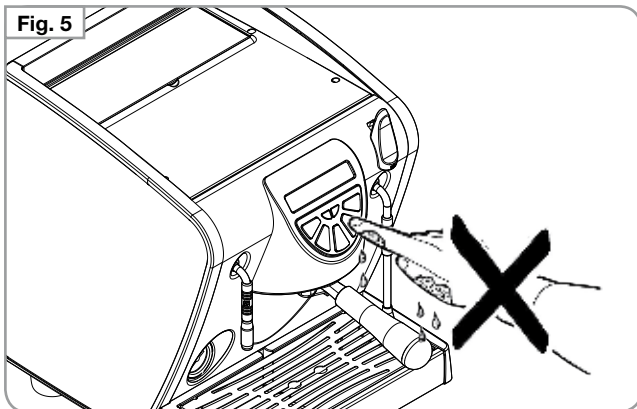
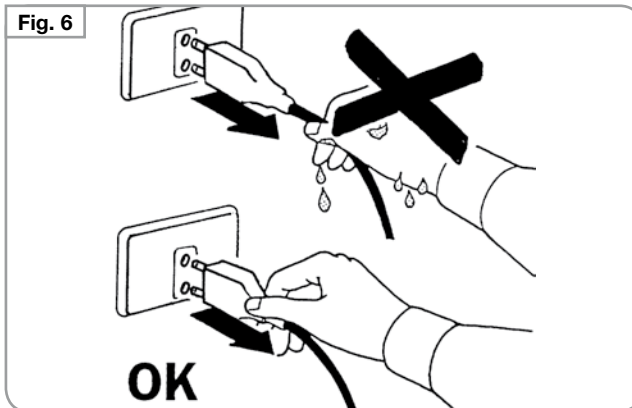
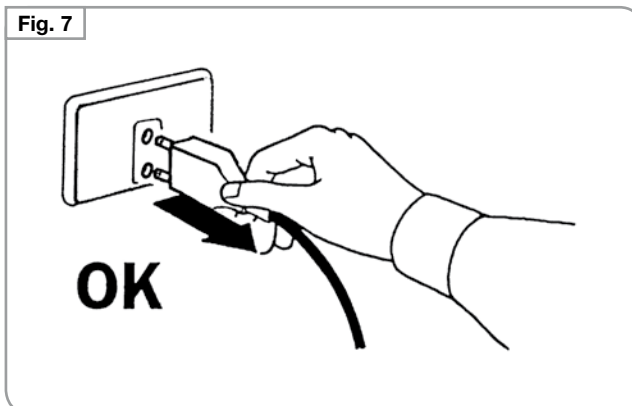

Fig. 6



Before performing any sort of maintenance, the authorized technician must turn off the unit and unplug it from the mains.

Fig. 7



Before cleaning the unit set it in a state of "0" energy: that is, "MACHINE SWITCHED OFF AND UNPLUGGED". Follow the instructions given in this manual carefully.

For cleaning and maintenance please refer to chapter 7.

In case of breakdown or poor function, turn off the unit. Never tamper with the unit. Contact only professionally qualified personnel.

Only the manufacturer or an authorized service center can make repairs and only using original spare parts.

No compliance with the above can compromise machine safety.

Upon installation, the qualified electrician must arrange for an omnipolar switch, as called for by the safety regulations in force and which performs a complete disconnection under the conditions of over tension category III. When open, the contacts must be 3 mm or more apart.

To prevent dangerous overheating, it is advisable to fully extend the power supply cord.

Never block the intake and/or heat dissipation grills, in particular those for the cup warmer.

Fig. 8

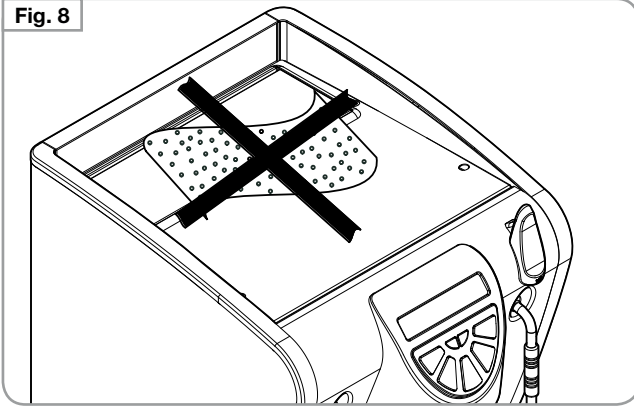

- ☞ The user must never replace the unit's power supply cord. If this cord is damaged, turn off the unit and have it replaced by a professionally qualified technician.
- ☞ Should you decide to stop using this type of unit, we suggest you render it inoperable by unplugging it and cutting the power supply cord.



WARNING
DANGER OF POLLUTION

Fig. 9

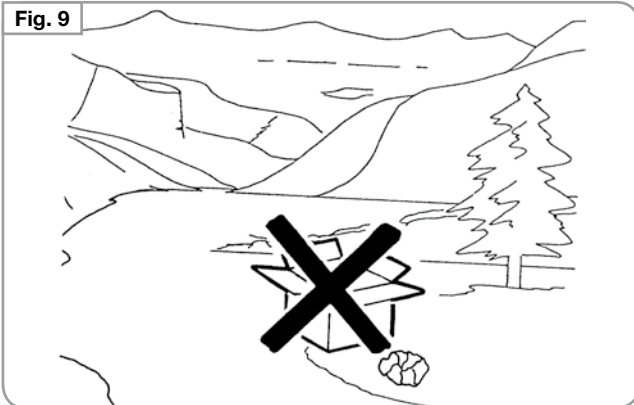

- ☞ Never dispose of the machine in the environment: to dispose of the machine, contact an authorized center or contact the manufacturer for pertinent indications.
- ☞ To facilitate aeration of the unit, position the aeration portion of the machine 15 cm (5,9 in) from walls or other machinery.
- ☞ Once you have started washing the machine, complete the job or residues of detergent could be left inside the dispensing assembly.
- ☞ Do not plug the appliance in water during cleaning.



WARNING
DANGER OF INTOXICATION

- ☞ Be extremely careful when using the steam nozzle. Never place your hands under the nozzle and never touch it right after use.



CAUTION
DANGER OF BURNS

Fig. 10

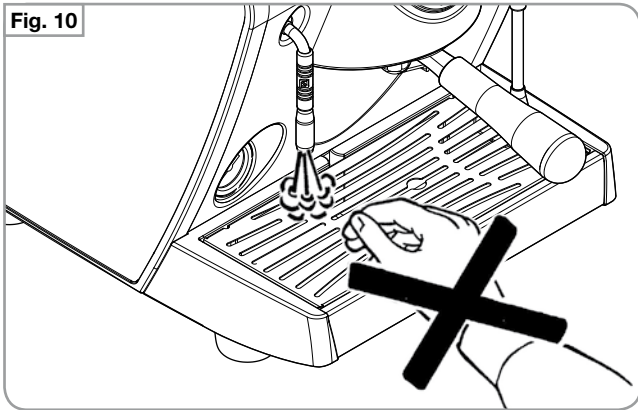

- ☞ Remember that to install, maintain, unload and regulate the unit, the qualified operator must always wear work gloves and safety shoes.
- ☞ When adding the coffee, the operator must never put his hands into the container.
- ☞ The noise level of the machine is less than 70db.
- ☞ For machines connected to the main water supply, this connection must be made in compliance with current standards in the country of installation and the maximum pressure for the correct operation of the machine must not exceed 0,6 MPa.

**CAUTION****INFORMATION TO THE USERS**

Under the senses of art. 13 of Law Decree 25th July 2005, n. 151 “Implementation of the Directives/Guidelines 2002/95/CE, 2002/96/CE and 2003/108/CE, concerning the reduction of the use of dangerous substances in electric and electronic equipment, as well as the disposal of wastes”.

The symbol of the crossed large rubbish container that is present on the machine points out that the product at the end of its life cycle must be collected separately from the other wastes. The user for this reason will have to give the equipment that got to its life cycle to the suitable separate waste collection centres of electronic and electrotechnical wastes, or to give it back to the seller or dealer when buying a new equipment of equivalent type, in terms of one to one. The suitable separate waste collection for the following sending of the disused equipment to recycling, the dealing or handling and compatible environment disposal contributes to avoid possible negative effects on the environment and on the people's health and helps the recycling of the materials the machine is composed of. The user's illegal disposal of the product implies the application of administrative fines as stated in Law Decree n.22/1997” (article 50 and followings of the Law Decree n.22/1997).

1.4 MACHINE IDENTIFICATION

Always quote the machine serial number in all communications to the manufacturer, **Nuova Simonelli**.

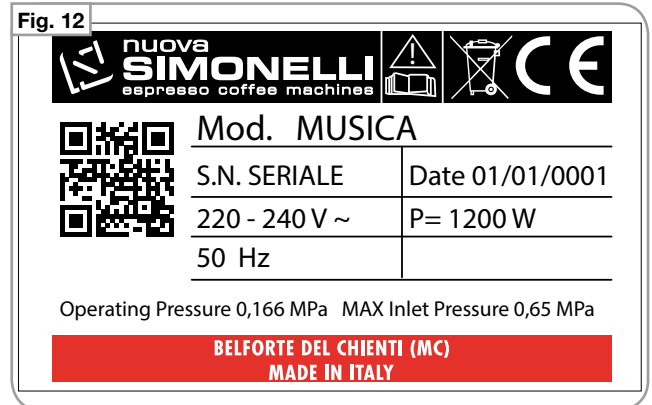
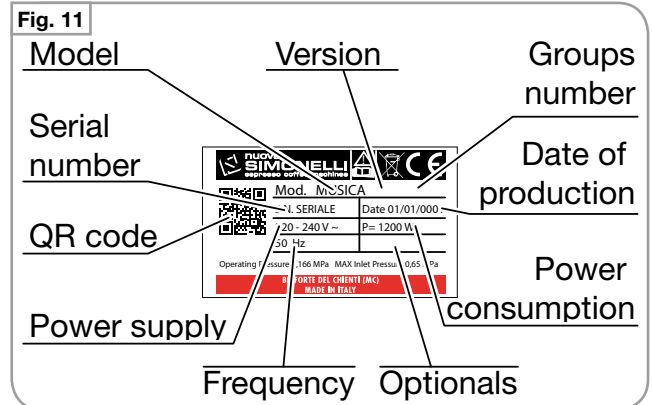

The machine internet page can be accessed directly through the QR code.

By downloading and installing one of the apps to read such codes on a mobile device. Start the app and position the camera in front of the code so that it can be clearly seen. Wait some time while the app processes the result and shows the internet page of the machine on the display.

1.5 TRANSPORT

The machine is transported on pallets which also contain other machines - all boxed and secured to the pallet with supports.

Before carrying out any transport or handling operation, the operator must:

- put on work gloves and protective footwear, as well as a set of overalls which must be elasticated at the wrists and ankles.

The pallet must be transported using a suitable means for lifting (e.g., forklift).

1.5.1 HANDLING



WARNING
COLLISION OR CRUSHING HAZARD

During the entire handling operation, the operator must make sure no one or nothing is inside the operating area.

Slowly lift the pallet to about 30 cm from the ground and move to the loading area. After making sure there are no obstacles, persons or things, proceed with loading.

Once at destination, always using an adequate lifting mechanism (e.g. fork-lift), after making sure there is no one or nothing within the unloading area, lower the pallet to about 30 cm from the ground and transport it to the storage area.



WARNING
COLLISION OR CRUSHING HAZARD

Before performing the following operation, make sure the load is in place and is not likely to fall when the straps are cut.

The operator, wearing safety gloves and footwear, must now cut the straps and store the product. To perform this operation, check the technical characteristics of the product to determine the weight of the machine to be stored and take consequent precautions.

2. FIRST INSTALLATION AND PRELIMINARY OPERATIONS

INDEX

2. FIRST INSTALLATION AND PRELIMINARY OPERATIONS	2.1
2.1 FIRST INSTALLATION	2.2
2.1.1 WEIGHT AND DIMENSIONS	2.2
2.1.2 CONNECTION TO THE WATER LINE AND DRAINAGE SYSTEM	2.3
2.1.3 TECHNICAL SPECIFICATIONS	2.4
2.1.4 CONNECTION TO THE POWER LINE	2.4
2.1.5 PROCEDURE OF FIRST INSTALLATION	2.5
2.2 ACCESSORIES BOX	2.7
2.2.1 FITTING THE FILTER HOLDER	2.7
2.3 COFFEE DOSE SETTING	2.8



RISK OF POLLUTION

DO NOT DISPOSE PACKAGING in the environment.

Prior to installation please carefully read the safety instructions in this manual. The company cannot be held responsible for damage to persons or property arising from non-compliance with safety regulations, either during installation or maintenance of the machine described in this manual.

Fig. 13

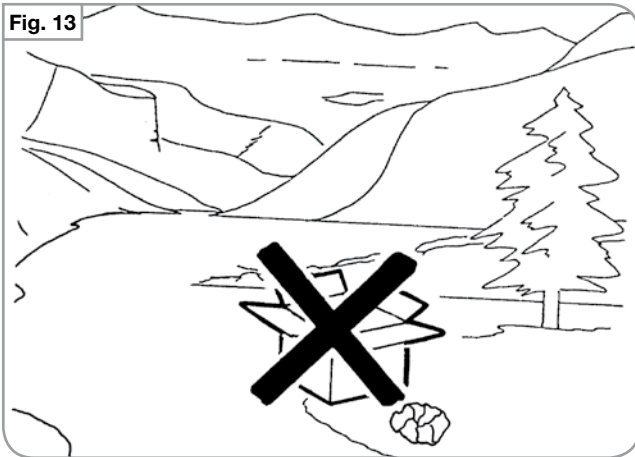

WARNING

Place the machine in an area where all risks of malfunction can be avoided.



WARNING

Never install in areas where the machine may be subject to jets of water.

2.1 FIRST INSTALLATION

2.1.1 WEIGHT AND DIMENSIONS

NET WEIGHT	20 kg	44,1 lb
GROS WEIGHT	23 kg	50,7 lb
POWER	1200 W	1200 W
DIMENSIONS		

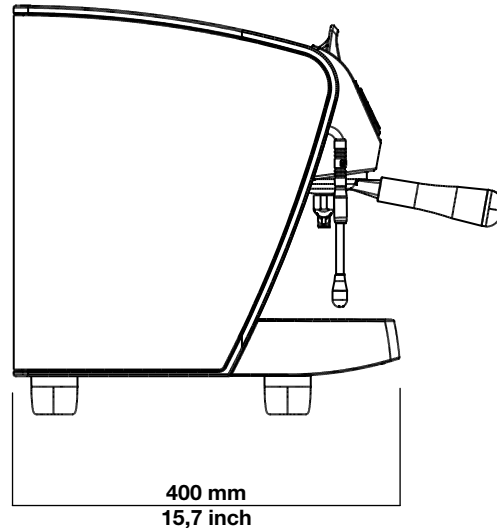
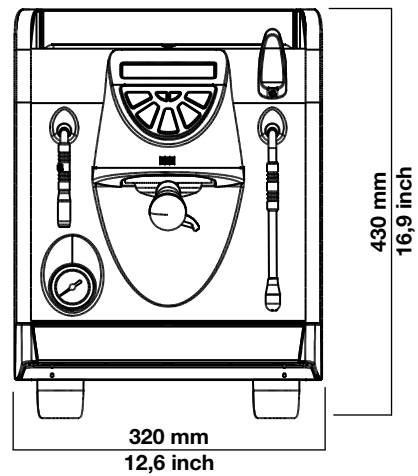

2.1.2 CONNECTION TO THE WATERLINE AND DRAINAGE SYSTEM

The machine requires stringent specifications to prevent the formation of limescale and to ensure quality beverages. The main features required to achieve high standards of performance are the following:

Total hardness	50 -60 ppm
Waterline pressure	2-4 bar, cold water
Minimum flow	200 l/hr
Filtration	Less than 1.0 micron
Alkalinity	10-150 ppm
Total dissolved salts (TDS)	50 -100 mg/L
Chloride	< 0.5 mg/L
pH	6.5- 8.5

It is the task of a qualified technician to:

- 1 Adapt the water from the waterline to the specifications required using filters and water softeners;
- 2 Train the final user so that the equipment for water treatment is constantly kept perfectly operational.

The version with direct coupling is provided with a loading tube 1,5 meters long with a 3/4 inch. On one side is the fitting is straight and tapered, the other angled at 90° with a gasket. The tube is provided with tapered fittings therefore it is not necessary to use Teflon tape on the fitting.

To connect the machine to the waterline, proceed as follows:

- 1 Remove the pipe from the upper door "A" and connect one of its ends to fitting "B" situated on machine base.
- 2 Connect the other end of the pipe to the waterline using a 3/8" fitting.



NOTE

Dirty water drainage is carried out through the drip tray both for version with connection to the waterline and with tank.



WARNING

If the water features do not comply, the warranty will automatically expire.

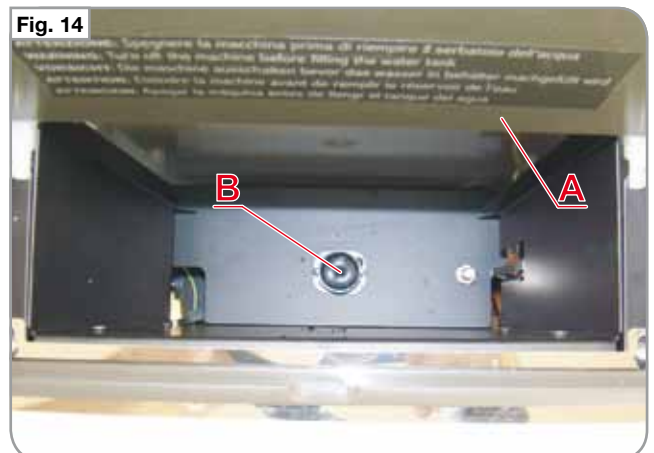

2.1.3 TECHNICAL SPECIFICATIONS

The machine is available in the following versions:

- single-phase 120 V 60 Hz (tank and waterline)
- single-phase 230 V 50 Hz (tank and waterline)
- single-phase 230 V 60 Hz (waterline)

The relative power absorbed is indicated on the machine plate.

2.1.4 CONNECTION TO THE POWER LINE



WARNING RISK OF SHORT CIRCUITS

- Plug the machine into the mains socket; the LED of the on switch will begin to flash.
- Hold down the on switch for 2 seconds.
- The fact that the machine is operating is shown by the LED of the on switch and all delivery keys, which remain lit.

For creamy coffee, wait about 25 minutes after switching on the machine.



NOTE

Once the auto diagnosis has been completed all the keys are activated.

Fig. 15

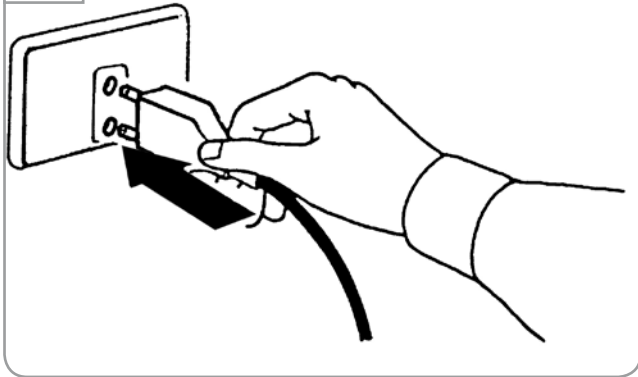

2.1.5 PROCEDURE OF FIRST INSTALLATION

Before installing the unit, carefully read the safety instructions at the beginning of this manual.

Arrange the accessories as follows:

- 1 Insert the ring (3) inside the seat of the filter holder.
- 2 Insert one of the two filters (1 or 2).

Tank Model

- 3 Open the hatch (14) and take out the reservoir (1).
- 4 Especially the first time, wash the reservoir with soap and water.
- 5 Fill the reservoir with water and make certain that the outside of the reservoir is dry.
- 6 Return the reservoir (1) to its housing and close the hatch (14).

Model for Direct connection to the water mains.



WARNING

When connecting the mains water supply, always use a new pipe, suitable for this purpose.

- 3 Remove the tube from the hatch (14) on the top part of the machine.
- 4 Connect the end of the pipe to the fitting on the base of the machine.
- 5 Connect the other end of the tube with the 1/8" union to the mains water supply.
- 6 Make certain that the water drain tank (7) has been inserted.

Fig. 16

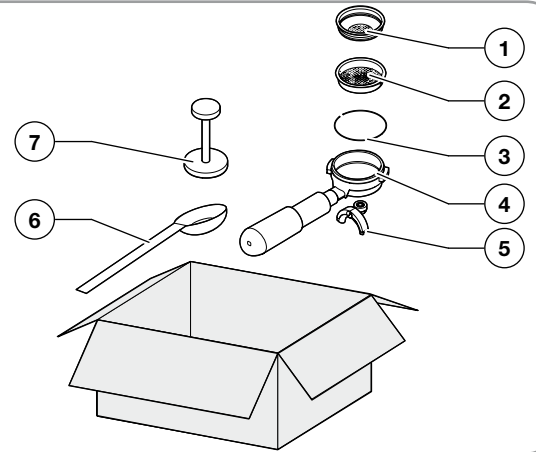

Make certain that the cup support grill (8) is positioned squarely and is level.

- 7 Make sure that the steam knob (2) is closed, facing down.
- 8 Make certain that the line voltage corresponds to the requirements indicated on the label.
- 9 Only insert the plug in the socket if the steam knob (2) is closed and the mains voltage is the correct one.
- 10 The preliminary operations have been completed and the machine is ready to be set up.



NOTE

At the start of the day's activities and in any case, if there are any pauses of more than 8 hours, then it is necessary to change 100% of the water in the circuits, using the relevant dispensers.



NOTE

In case of use where service is continuous, make the above changes at least once a week.



NOTE

If water level in the tank is not enough or the pump remains on for more than 90 seconds, the machine will stop and all keys will blink. By switching the machine off and on, the filling procedure of tank will continue until the appropriate level is reached.



NOTE

In case water is not filled when starting the machine for the first time:

- 1 the cause may be an air bubble between the pump and the tank, which prevents flow of water.
- 2 check the tank valve for correct operation.
- 3 remove and re-install the tank full of water several times to facilitate air bubble removal.

2.2 ACCESSORIES BOX

Machine is supplied with an accessories box consisting of:

- 1 Single filter
- 2 Double filter
- 3 Spring
- 4 Filter holder
- 5 Dispensing nozzle
- 6 Coffee doser
- 7 Coffee presser

2.2.1 FITTING THE FILTER HOLDER

To properly mount the filter holder:

- 1 Insert the spring inside the pay slot inside the filter holder.
- 2 After selecting the appropriate filter (1 or 2), insert the filter in the filter holder until you hear the snap with spring.
- 3 Screw the dispensing spout up to place it perpendicular to the handle.



NOTE

To change the filter inserted, pry up the edge with one of the other filters.

Fig. 17

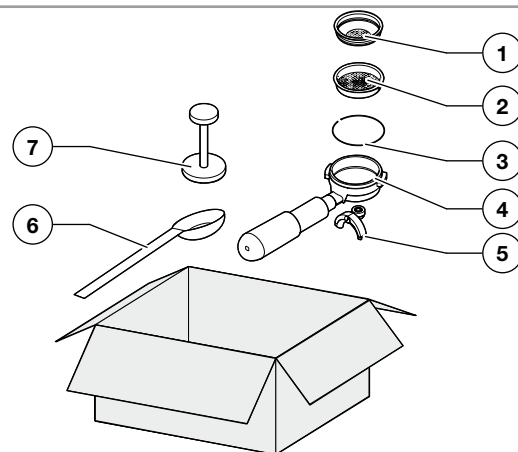

2.3 COFFEE DOSE SETTING

To enter the programming mode, proceed as follows:



NOTE

The procedure can be carried out with the machine on.

- To enter the dose programming mode, it is necessary to press and hold down the continuous dispensing key  for 5 sec.
- The delivery keys will begin to flash.

Coffee dose setting

To programme the amount of water for each of the delivery keys, proceed as follows:

- Fill the filter holder with the right amount of coffee (the double or single filter holder can be used, according to the key to be programmed).
- Place the filter holder in the group.
- Press one of the delivery keys:



- Dispensing will commence; once the required quantity has been poured, press the same key again.



- Press the  key to quit the programming mode.

Fig. 18



Fig. 19



Hot water dose setting





- Use the relevant procedure to enter the programming function.
- Press the hot water selection key .
- Hot water delivery will begin.
- Decide the required amount of hot water and then press the key  again.
- Press the  key to quit the programming mode.

Fig. 20



Standard dose setting

- It is possible to enter pre-set values for the group doses and hot water. To do this, it is necessary to press the key  and hold it down for at least 10 seconds until the flashing keys switch off.

The doses are:

1CN	2CN	CONT.	WATER
80 cc	120 cc	160 cc	45 sec.





NOTE

Setting a time of 0 seconds for the water causes it to operate in continuous mode.







Fig. 21



Additional functions

Also within the programming function (while no pouring is in progress), pressing the “” key and then holding it down and pressing the “””, opens the page for setting the parameters:

- 1 Software block activation to enter the dose programming mode.
- 2 Keypad brightness adjustment.
- 3 Dose pre-infusion activation.

- The  key serves to enable the software block to enter the dose programming mode (key lit) or disable it (key off). To remove a software block for programming, it is necessary to quit the dose programming mode and follow these steps: from OFF status, switch the control unit to ON and as soon as the Lamp-test begins, release the  key and press the  and  keys together, holding them down until the Lamp-test is complete.
- The  key, which flashes, is used to choose the brightness of the keys from the 9 pre-set levels. Pressing the  key will reduce the brightness setting as far as minimum, to then start again from the maximum value.
- Pressing the  key will start the pre-infusion (approx. 3 sec.) for dispensing (key lit) or it will switch it off (key off).

Pressing the  key will quit the parameter setting functions and return to the dose programming mode.

3. REMOVAL OF THE EXTERNAL SURFACE

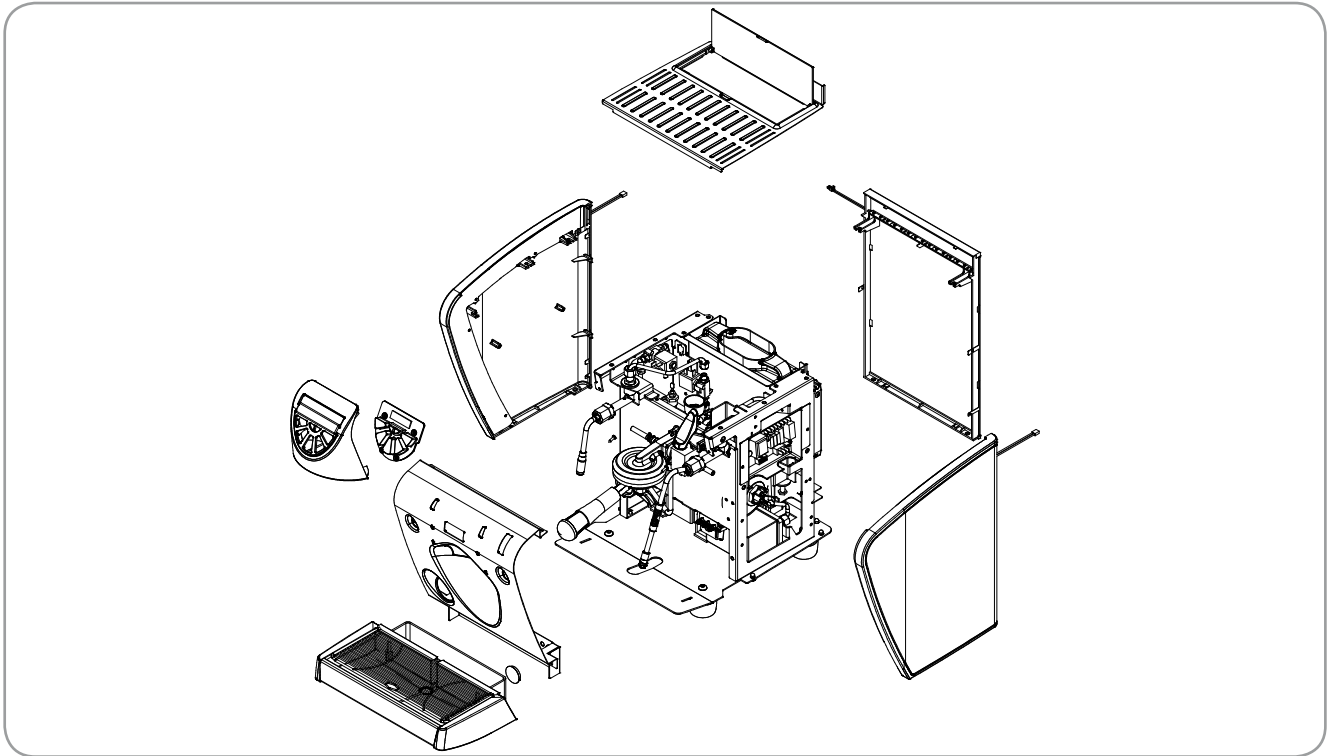

INDEX

3. REMOVAL OF THE EXTERNAL SURFACE	3.1
3.1 REMOVAL OF WATER TANK	3.2
3.2 REMOVAL OF THE CUP HOLDER SURFACE	3.3
3.3 REMOVAL OF THE SIDE PANELS.....	3.4
3.4 REMOVAL OF THE REAR PANEL	3.5
3.5 REMOVAL OF THE FRONT PANEL.....	3.6
3.6 REMOVAL OF KEYBOARD.....	3.8

TOOLS NEEDED:



DANGER

Use gloves to protect against sharp or hot surfaces that you can bump against involuntarily during operations.

NOTE

Before proceeding with the removal of the panels it is advisable to clean and free up enough space where the machine parts will rest so that they are not be unintentionally damaged.

DANGER

Before proceeding with the operations described in the chapter make sure that the machine is turned off and unplugged from the mains. Discharge any residual pressure present in the heater.

3.1 REMOVAL OF WATER TANK

To remove machine covers, take out the water tank first:

NOTE

This operation is necessary only for the version with tank.

To remove the tank from its seat, proceed as follows:

- 1 Lift the water tank cap.

Fig. 22



**CUTTING
AND
HOT
SURFACES**

Fig. 23

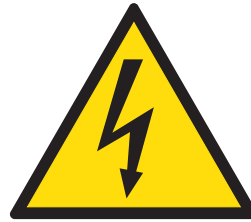

DANGER

Fig. 24



- 2 Pull the water tank upward

3.2 REMOVAL OF THE CUP HOLDER SURFACE

To remove the cup holding surface, proceed as follows:

- 1 Loosen the screws "A" using a 2,5 mm Allen key.

- 2 Raise the panel and take it out backward.

Fig. 25



Fig. 26

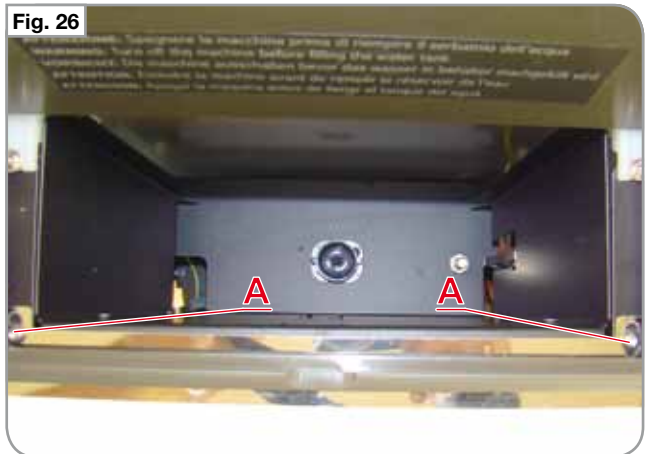
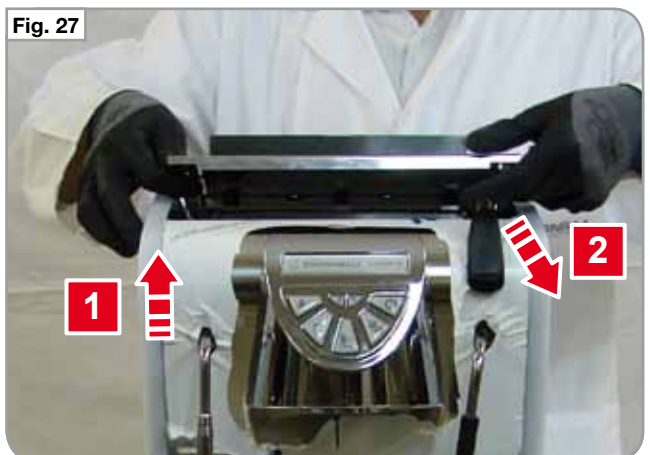

Fig. 27



3.3 REMOVAL OF THE SIDE PANELS

NOTE

To remove the side panels, it is necessary to remove the cup holding surface first.

1 Loosen the screws "A" of each panel using a 2,5 mm Allen key.

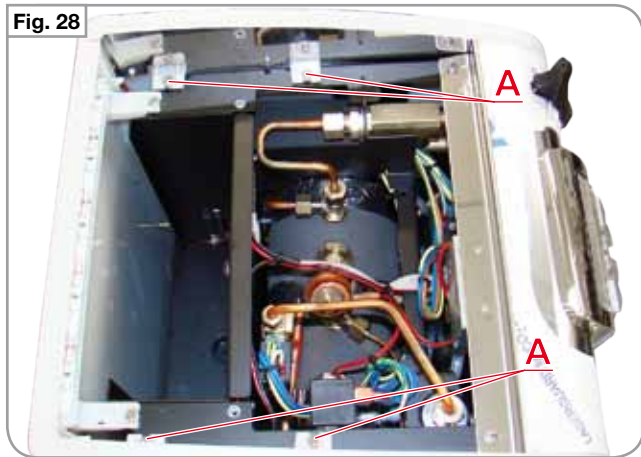

2 Loosen the screws "B" on the front side (underneath the frame) of the front panel using a Phillips screwdriver.

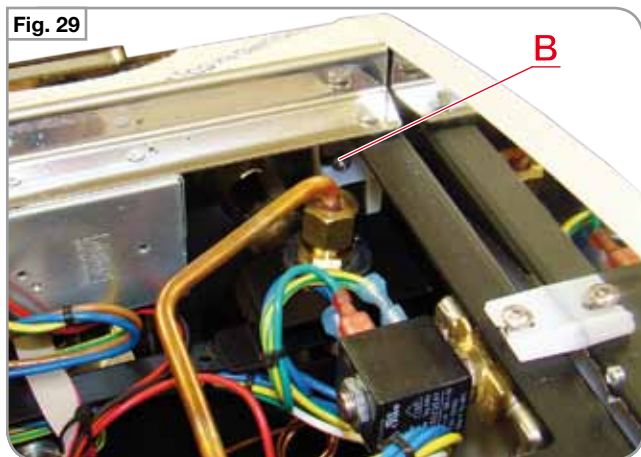

3 For LUX version, disconnect the LEDs before completely removing the panel.

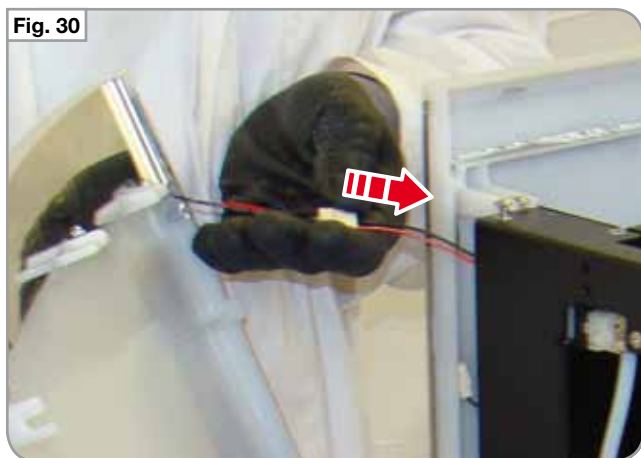

- 4 Raise the panel and take it out.

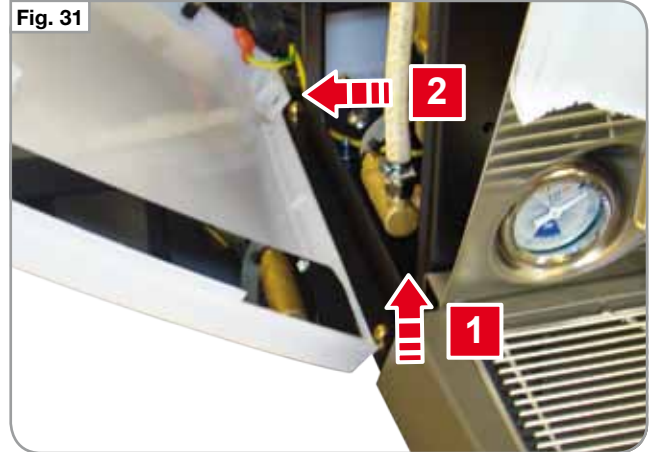

3.4 REMOVAL OF THE REAR PANEL

NOTE

To remove the back panel it is necessary to remove both side panels first.

Proceed as follows:

- 1 Loosen the screws "A" of the panel using a 2,5 mm Allen key.
- 2 For LUX version, as in case of side panels, disconnect the LEDs before completely removing the panel.
- 3 Raise the panel and take it out backward.

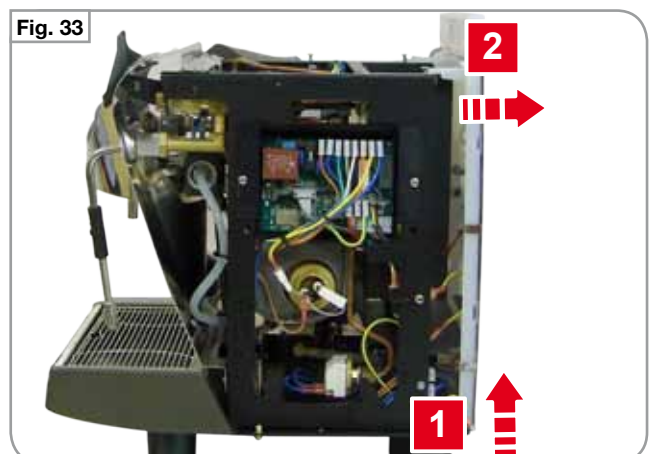
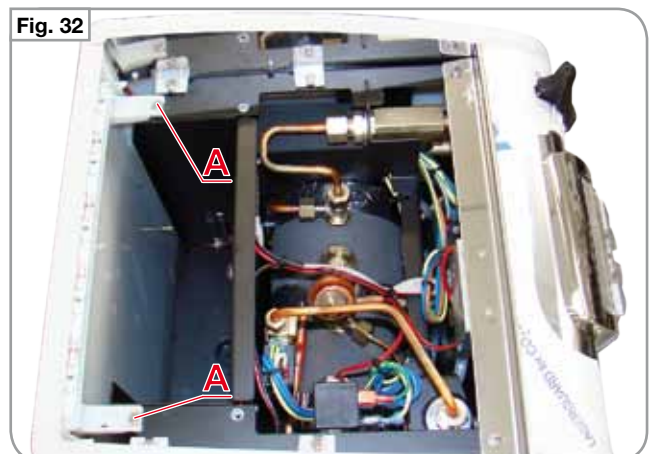

3.5 REMOVAL OF THE FRONT PANEL

NOTE

To remove the front panel, it is necessary to remove the right side panel first.

- 1 Loosen the locking nut "A" of steam valve using a 3 mm Allen key.
- 2 Release the valve by pulling the steam lever "B" towards the machine front side.

- 3 Loosen the upper screws "C" of the front panel using a 3 mm Allen key.

- 4 Loosen the lower screws "D" of the front panel using a Phillips screwdriver.

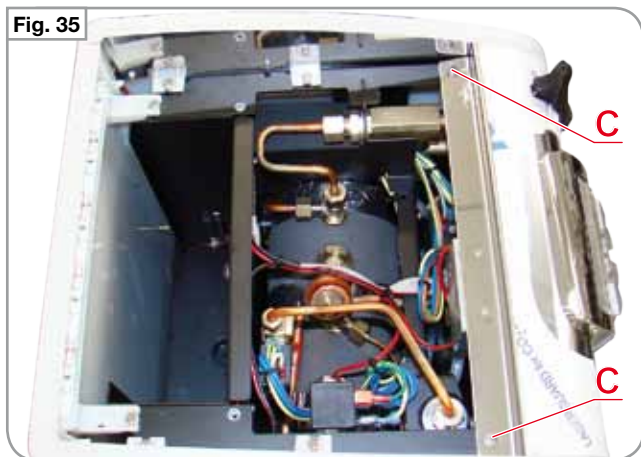
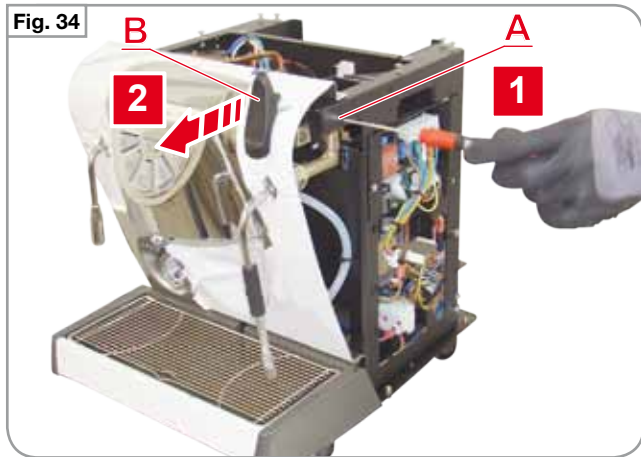

- 5 Disconnect keyboard wiring.

NOTE

For LUX version, remove the light transformer before disconnecting the keyboard. Loosen the corresponding screws "E" by means of a Phillips screwdriver.

- 6 Disconnect pipes of the coffee valve "F" and the ones of expansion valve "G".
- 7 Loosen the screw "H" by means of a Phillips screwdriver and remove the discharge collector toward the machine rear side.
- 8 Take out the front panel toward the machine front side.

Fig. 37

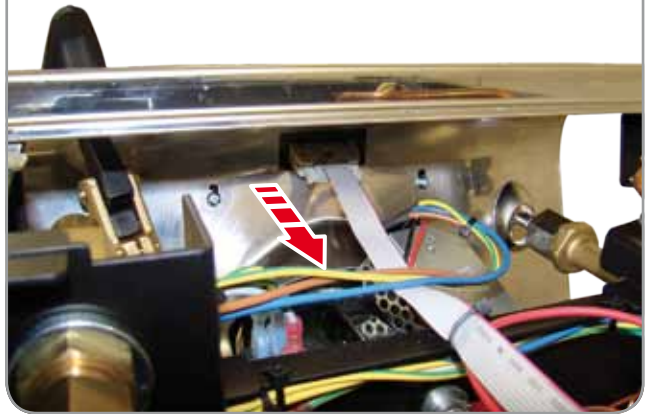

Fig. 38

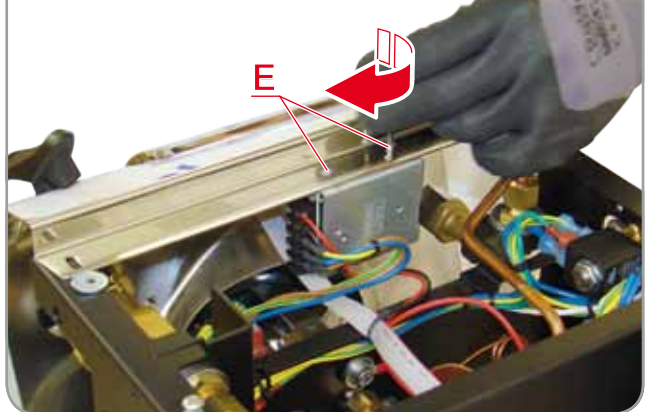

Fig. 39

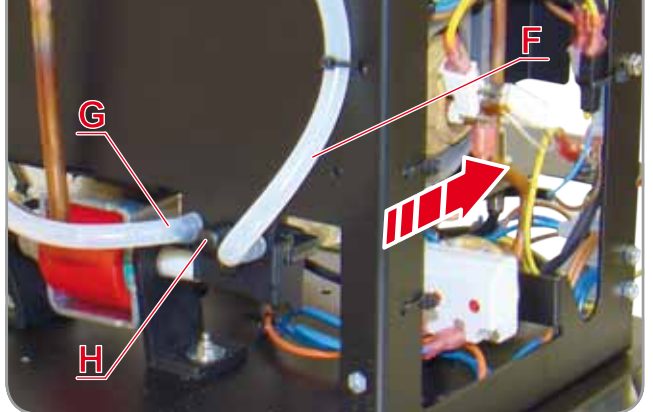

Fig. 40



3.6 REMOVAL OF KEYBOARD

NOTE

To remove the keyboard, it is necessary to remove the front panel first.

- 1 Loosen the 4 screws "A" situated on the back of the front panel using a Phillips screwdriver.

- 2 Loosen the 4 screws "B" situated on the keyboard panel using a Phillips screwdriver.

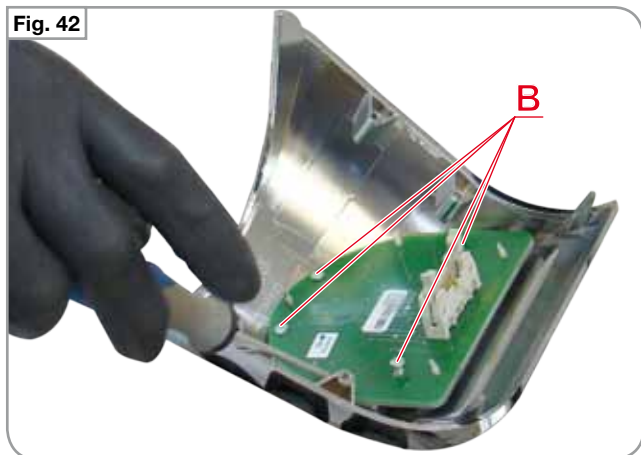
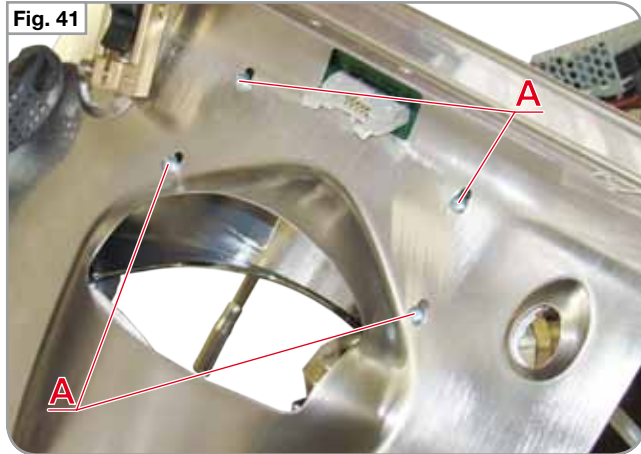

4. INFUSION UNIT

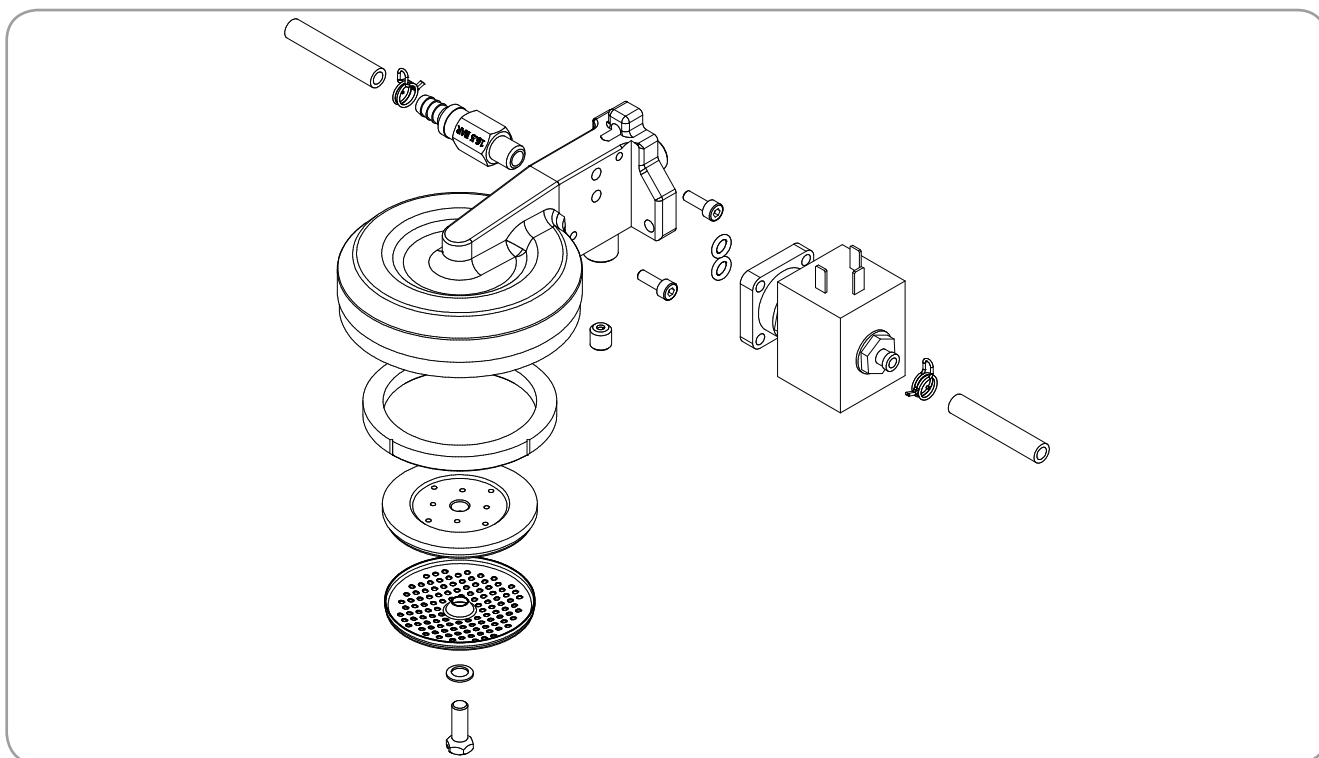

INDEX

4. INFUSION UNIT.....	4.1
4.1 REMOVAL OF SHOWER AND SEAL	4.2
4.2 COFFEE VALVE	4.3
4.3 EXPANSION VALVE	4.5

TOOLS NEEDED:



The underpan seal prevents water from coming out from the sides of the pavilion and reach the capsule unevenly or spill from the filter holder. Since the material is plastic and exposed to high temperatures, replace the seal periodically, at least once a year or according to machine operation, as it tends to deform, loosening elasticity and sealing.

Fig. 43



4.1 REMOVAL OF SHOWER AND SEAL

To remove the shower and pavilion it is sufficient to loosen the central screw under the unit.

Fig. 44



WARNING

If the machine was turned off recently, protect yourself with thermal insulation gloves.

Fig. 45



To change the seal use an awl or a slim flathead screwdriver and at first remove one edge of the seal and then remove it entirely. If the unit is worn out just insert shims under the seal so as to reduce the stroke of the filter holder.

Fig. 46



4.2 COFFEE VALVE

It is a solenoid valve that is normally closed and opens when it received a command to dispense coffee.

By closing the decompression removes any excess water from the filter holder.

TYPICAL PROBLEMS

Check the operation of the valve, if the unit continues to drip continuously or if the coffee capsule is too wet.

Possible causes:

- 1 The third passage of the valve is obstructed, therefore the final suction is less than it should be.
- 2 Shower and pavilion are blocked because of poor machine cleaning.

DANGER

Before proceeding with the operations described in the chapter make sure that the machine is turned off and unplugged from the mains. Discharge any residual pressure present in the heater.

HOW TO REPLACE THE COFFEE VALVE:

To remove the coffee valve proceed as follows:

- 1 Remove the right, side panel and the front one, as explained in Chapter 3.
- 2 Disconnect power connections.

- 3 Disconnect the Teflon tube by removing the cable holder "A" using the pliers.

Fig. 47



Fig. 48

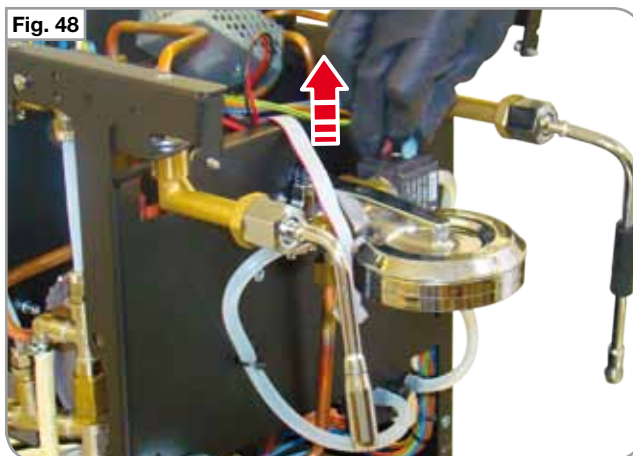
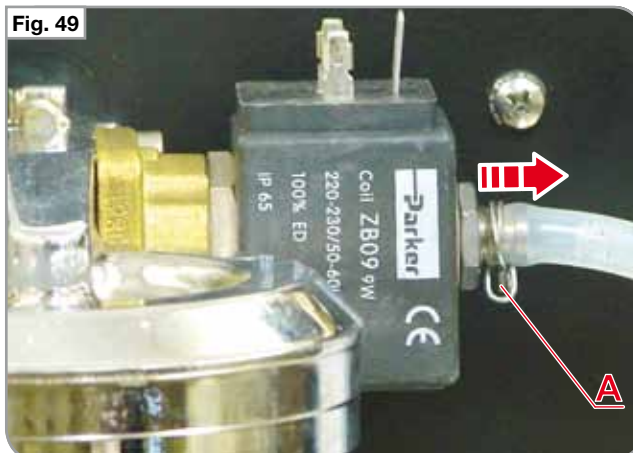
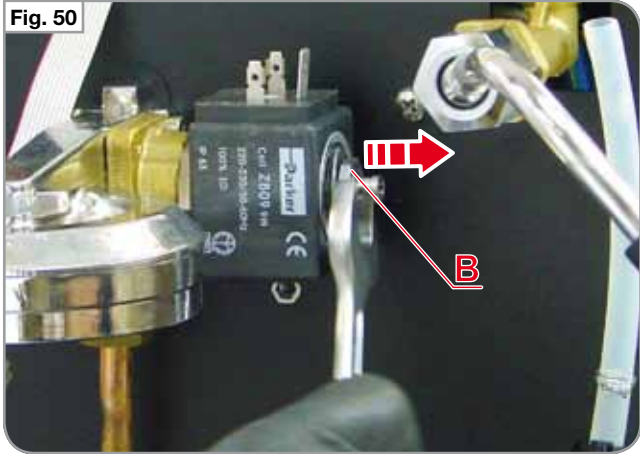

Fig. 49



- 4 Remove the washer and the locking nut "B" using a 14 mm wrench. Remove the coil.



- 5 Loosen the coil support "C" with a 24 mm wrench.

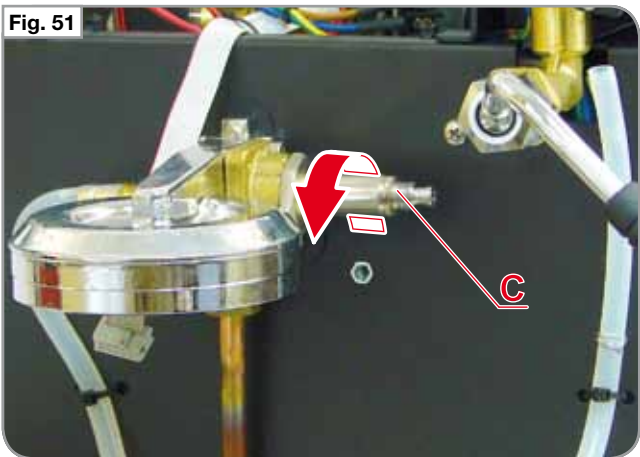

- 6 Use a 3 mm Allen key to remove the two screws that fix the head to the unit.

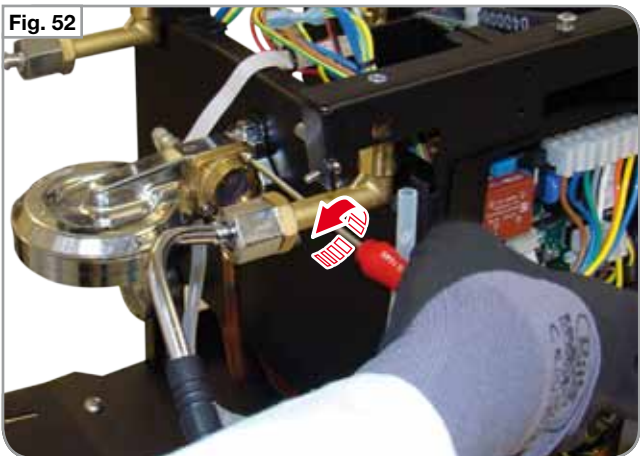

Remove limescale or oily residues that may block the free circulation of water.

NOTE

In case of oily residues, properly instruct the staff using the machine to perform a regular, deep cleaning with suitable detergents.



4.3 EXPANSION VALVE

To remove the expansion valve, proceed as follows:

- 1 Remove the front panel.
- 2 Disconnect the Teflon tube by removing the cable holder "A" using the pliers.

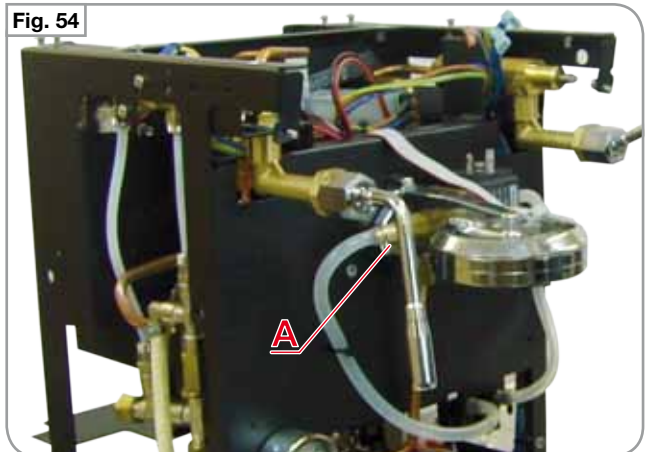

- 2 Loosen the valve with a 14 mm wrench.

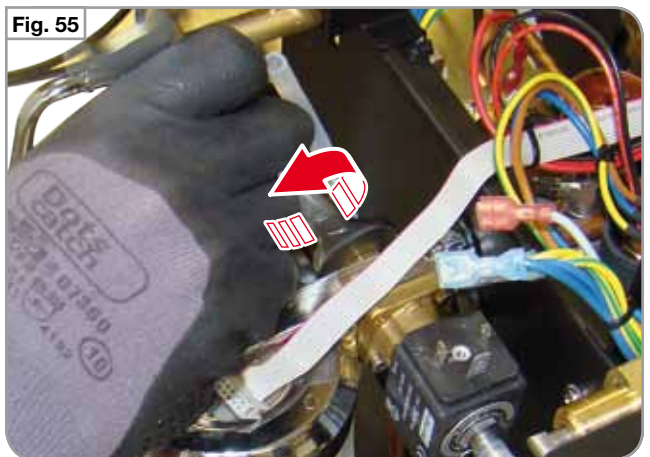

- 3 Apply Teflon tape on the new valve before screwing it.



5. HEATER

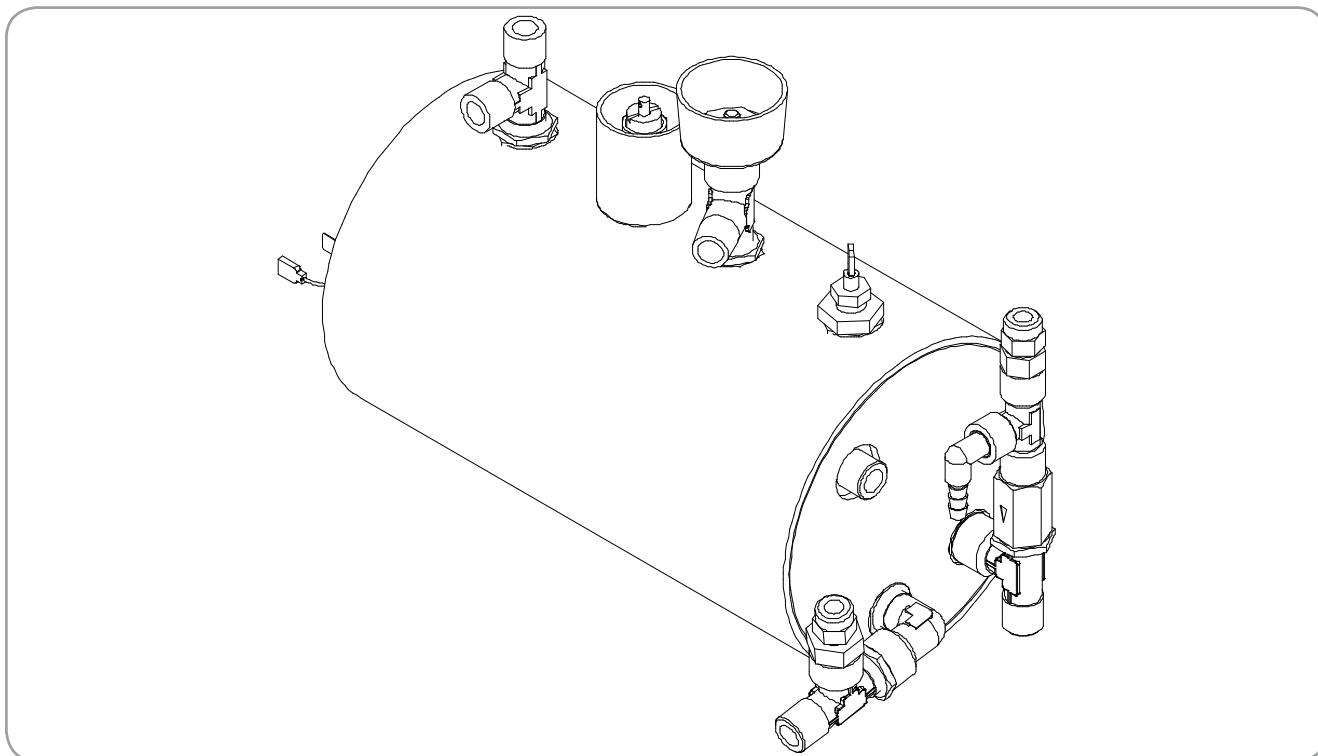

INDEX

5. HEATER	5.1
5.1 EMPTYING THE HEATER	5.2
5.2 REMOVAL OF THE HEATER	5.4
5.3 HEATING ELEMENT AND HEAT PROTECTION	5.5
5.4 REPLACEMENT OF THE LEVEL GAUGE	5.6
5.5 ANTI-SUCTION VALVE	5.7
5.6 SAFETY VALVE	5.8

TOOLS NEEDED:



5.1 EMPTYING THE HEATER



DANGER

Before proceeding with the operations described in the chapter make sure that the machine is turned off and unplugged from the mains. Discharge any residual pressure present in the steam heater.



WARNING

Before carrying out the heater emptying procedure, remove water inlet sources inside the waterline:

- Waterline version: close the water inlet tap and disconnect the pipe.
- Tank version: remove the tank from its seat.

These operations are necessary to avoid any water leakage inside the machine that may cause damage.



WARNING

Every time you work directly.

With the heater it is important to ensure that the internal pressure is zero. Completely remove the water inside for operations that require it.

To empty the heater proceed as follows:

- 1 Turn off the machine and let out all the steam by opening fully the steam outlets to lower the temperature quickly.
- 2 Remove covers:
 - Side panels;
 - Rear panel;
 - Front panel.
- 3 Place the machine on the right side to prevent water leakage and loosen the drain nut "A" using a 13 mm wrench.

Fig. 57

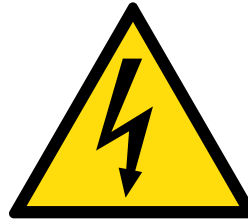

DANGER

Fig. 58

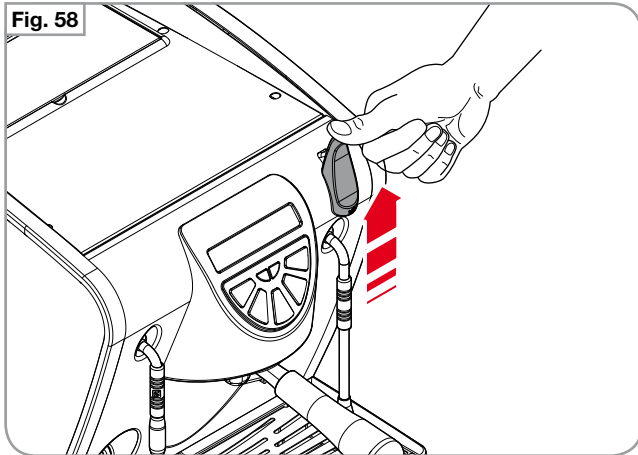

Fig. 59

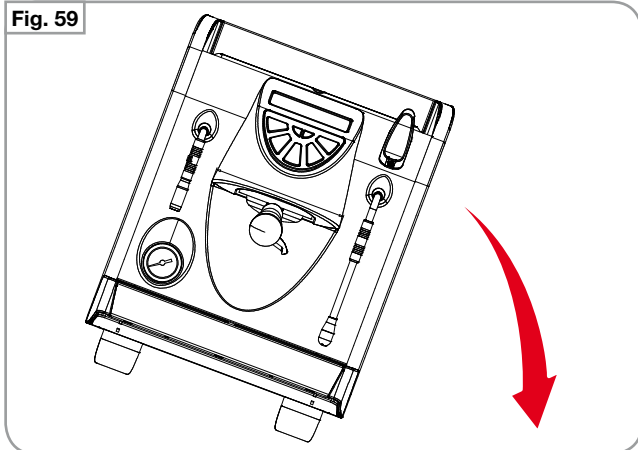
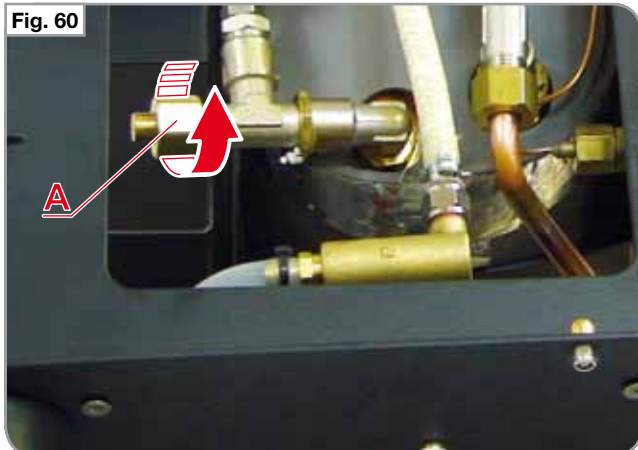
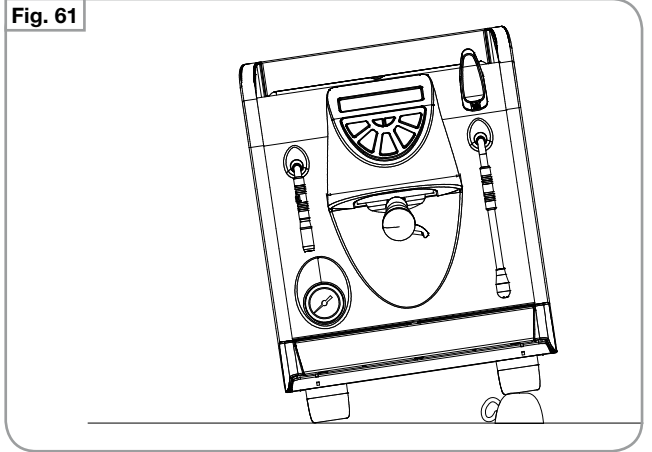

Fig. 60



- 4 Connect the drain pipe and tilt the machine on the left side to let the water out of the heater.

Fig. 61



- 5 After drainage of water from the heater, tighten the drain nut "A" using a 13 mm wrench.

Fig. 62

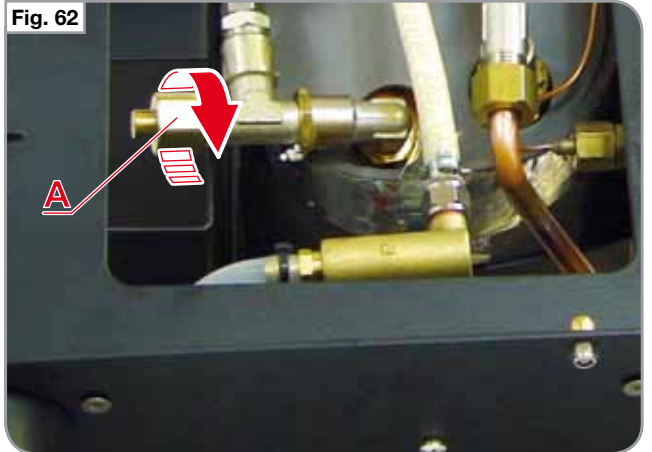

5.2 REMOVAL OF THE HEATER

In case of need, to remove the heater, it is necessary to discharge pressure.

Then, proceed as follows:

- 1 Remove machine covers:
 - Rear panel;
 - Side panels;
 - Front panel.
- 2 Empty water heater, as in the previous section.
- 3 Disconnect the level probe.
- 4 Disconnect the pressure gauge capillary.
- 5 Remove the fittings on the upper part of the heater with a 17 mm wrench.

- A** Steam Nozzle;
- B** Coffee delivery group;
- C** Hot Water Nozzle.

- 6 Remove the remaining fittings that hold the heater in place.
- 7 Remove the fittings on the left side:
 - A** using a 17 mm wrench;
 - B** using a 12 mm wrench.

The heater can be extracted from the machine. During the assembly phase of the new boiler, pay close attention to the restoration of the connections to ensure proper operation.

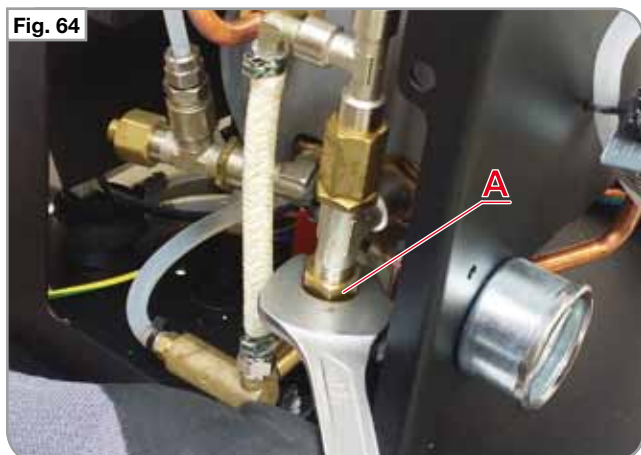
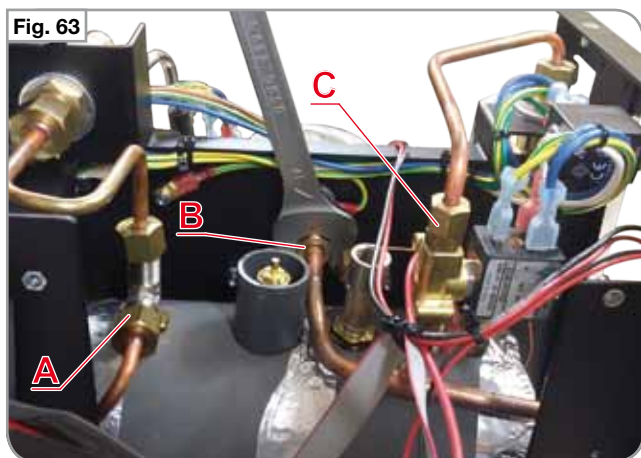

5.3 HEATING ELEMENT AND HEAT PROTECTION

To access the heating element, remove the right panel of the cover.

The visible parts are:

A 167° heat protection.

B Electrical connections of heating element.

MUSICA heater features a 1200 W heating element.

To remove the heating element, proceed as follows:

- 1 Empty the heater as described above.
- 2 Loosen the nut "A" using a 30 mm wrench.

- 3 Remove with care the panel out of its slot

NOTE

Each time you replace the heating element, it is also necessary to change the O-ring "B", which insulates it from the heater, as it is a part subject to wear. This component must be ordered along with the heating element.

Fig. 66

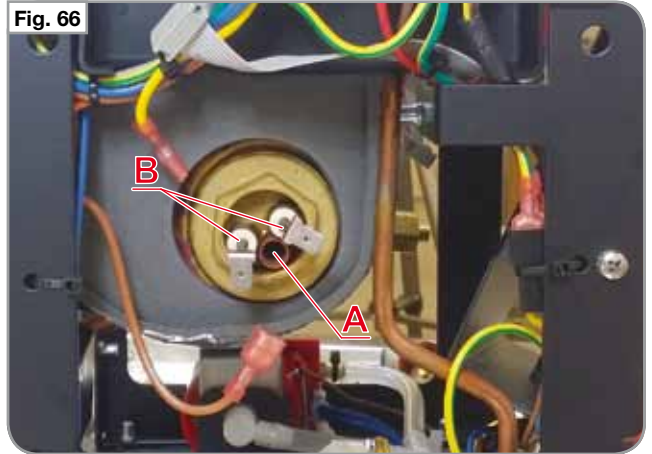

Fig. 67

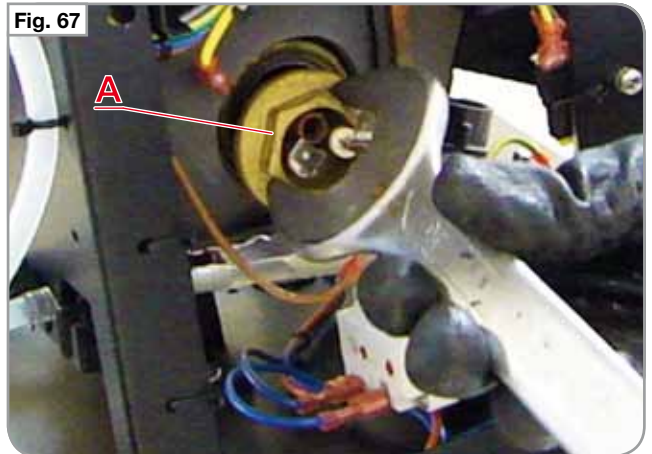

Fig. 68

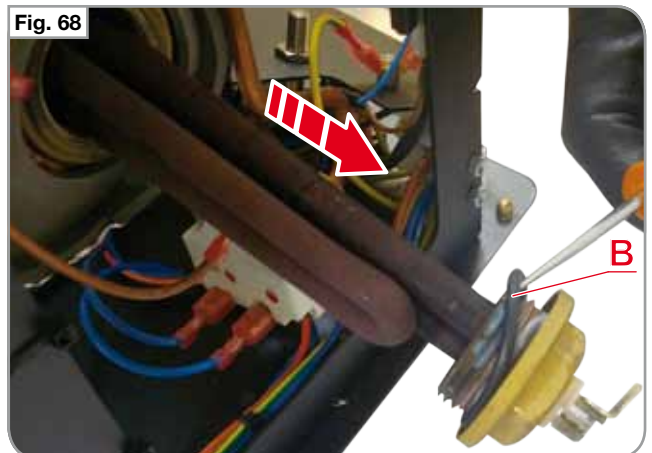
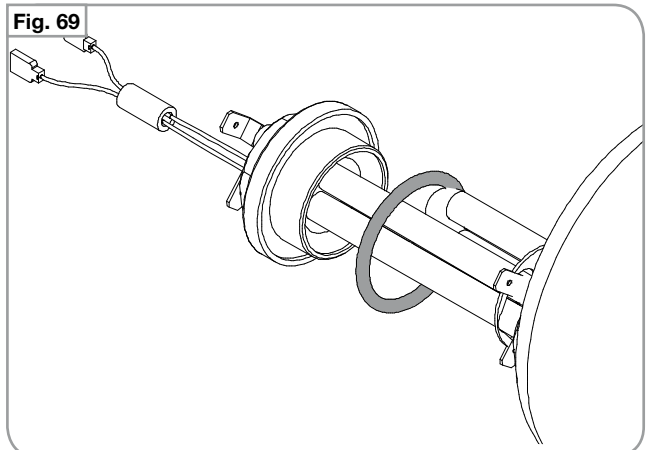

Fig. 69



5.4 REPLACEMENT OF THE LEVEL GAUGE

Water inside the heater is kept at a constant level through the use of a level probe.

This probe is connected to the electronic unit, which continuously checks water level.

Being always exposed to high temperatures and steam/water it is subject to encrustations which can inhibit operations.

WHEN TO INTERVENE

- In case it is verified that there are no problems upstream from the probe you can easily access the component and perform careful cleaning with abrasive or descaling agents.
- Make sure the Teflon coating of the probe is not damaged. In case of damage, steam leaks occur and it is necessary to replace the probe.

To remove the probe, simply disconnect the red wire "A" and unscrew the locking bolt "B" with a 16 mm wrench.

NOTE

When replacing the probe it is necessary to cover the threads with Teflon tape or liquid sealant.

Fig. 70



Fig. 71



Fig. 72



5.5 ANTI-SUCTION VALVE

The anti-suction valve ensures that air enters the heater during the machine cooling phase. In this way the reduction of water volume due to cooling does not create decompressions that may give rise to drawbacks such as the suction of milk through the steam nozzle.

WHEN TO REPLACE

You can assume that there are problems with the anti-suction valve when water coming out from heater is dirty.

The bad smell is generated from milk that has been sucked into the heater.
In these cases the valve is closed and is locked in this condition.

If the valve blocked open because of limescale the signs would be:

- A** Continuous slight whistling sound coming from the valve.
- B** Condensation drops near the valve.

NOTE

We suggest that the valve be replaced annually to ensure proper function and excellent sealing.

HOW TO REPLACE

Using a 19 mm cup hex wrench unscrew the valve from its housing.

When inserting the new one, coat the threads with Teflon tape or with a few drops of Loctite.

Fig. 73



Fig. 74

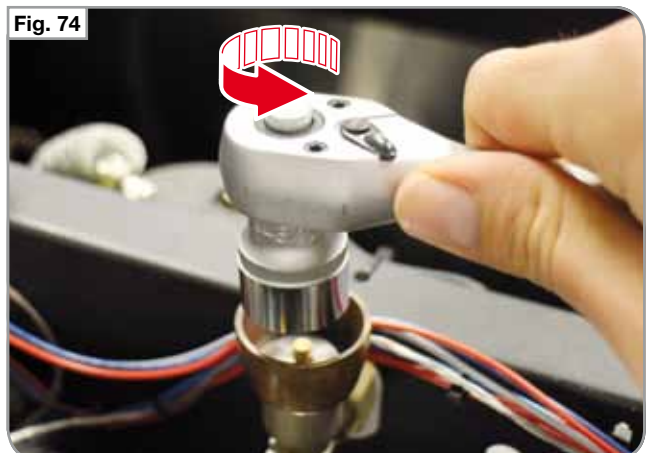

5.6 SAFETY VALVE

The heater safety valve “A” of heater serves to discharge excess pressure that may form owing to malfunctioning. The valve opens automatically when inner pressure of heater exceeds 2.1 bar.

WHEN TO REPLACE

For safety reasons **each time the valve comes into operation it should be replaced** to ensure perfect operation.

Therefore, in case of heater flooding or excess of steam, secure the machine by replacing the entire valve.

HOW TO REPLACE

Remove the safety valve “A” by unscrewing it with a 14 mm hex wrench.

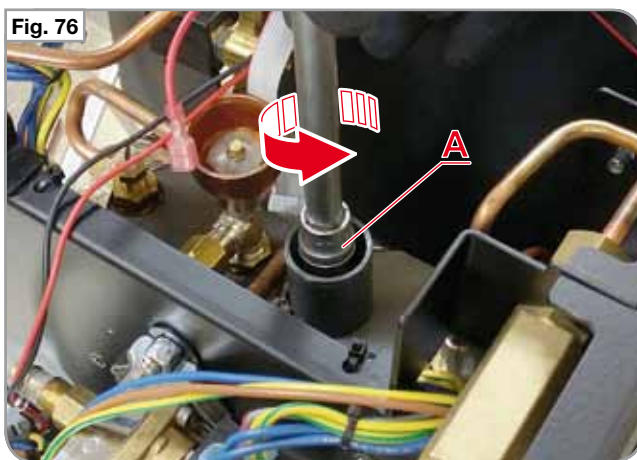
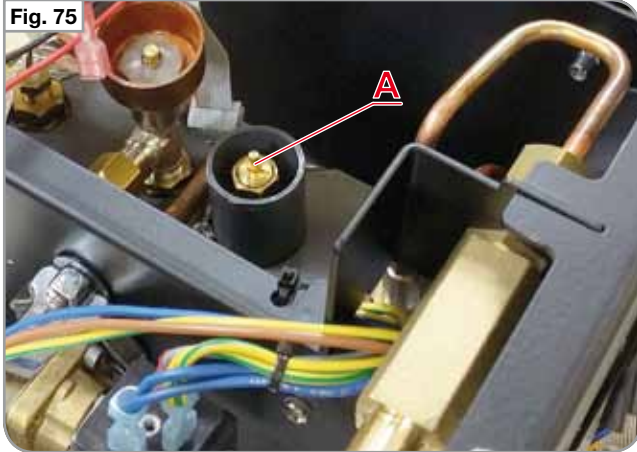

6. HYDRAULIC CIRCUIT

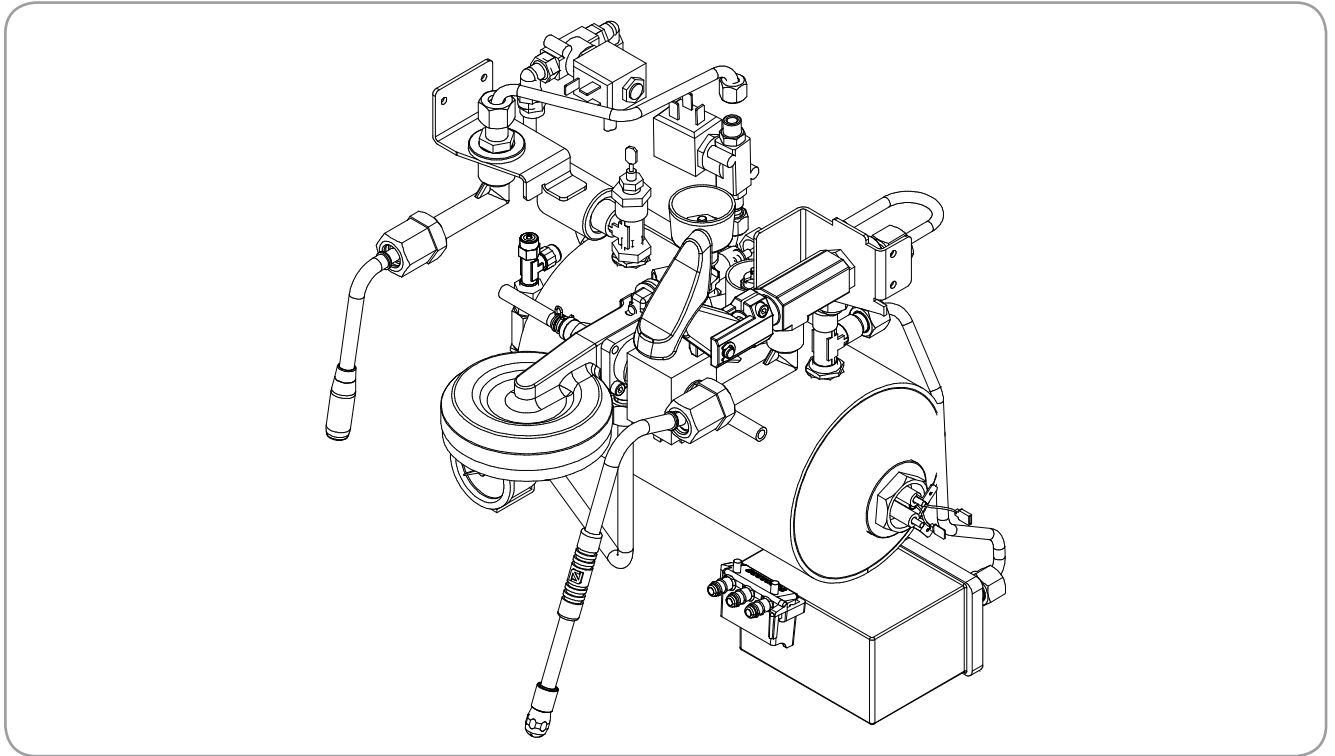

INDEX

6.	HYDRAULIC CIRCUIT	6.1
6.1	PUMP DISASSEMBLY	6.2
6.2	REPLACING THE COFFEE VALVE	6.4
6.3	FLOWMETER	6.6
6.4	HOT WATER VALVE	6.8
6.4.1	DISASSEMBLY OF HOT WATER NOZZLE	6.10
6.5	STEAM NOZZLE	6.10
6.6	WATER TANK	6.15
6.6.1	REPLACEMENT OF THE FLOAT	6.15
6.6.2	REMOVAL OF THE MAGNETIC SENSOR	6.16
6.6.3	REMOVAL OF THE TANK MICROSWITCH	6.16
6.7	REMOVAL OF THE PRESSURE SWITCH	6.17

TOOLS NEEDED:

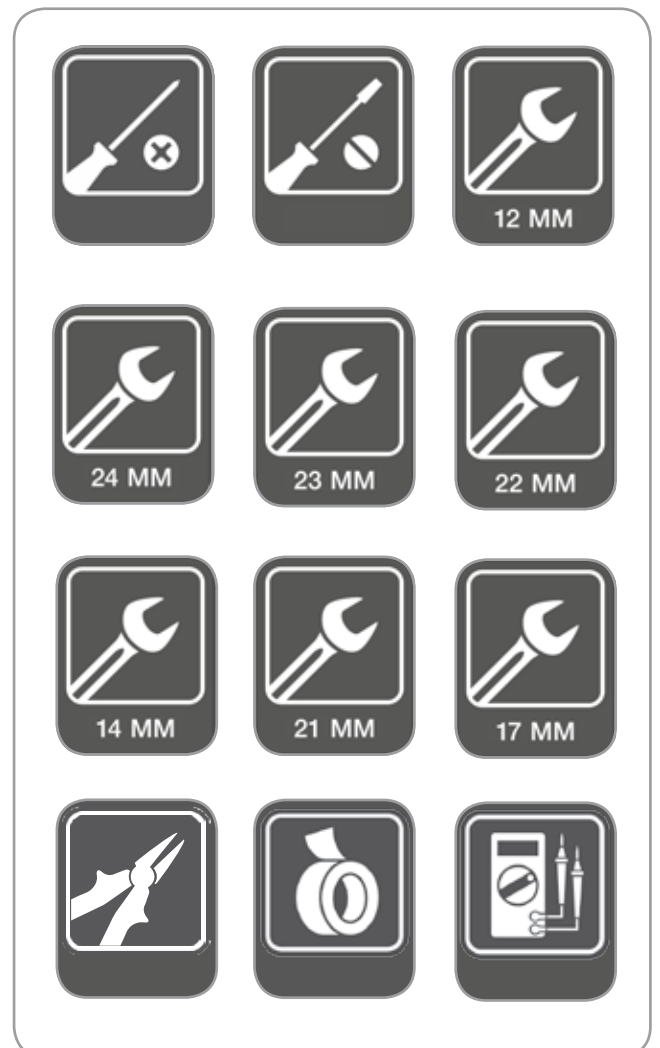

WARNING

Before carrying out the disassembly procedure of the hydraulic circuit, close water inlet sources inside the waterline:

- Waterline version: close the water inlet tap and disconnect the pipe.
- Tank version: remove the tank from its seat.

These operations are necessary to avoid any water leakage inside the machine that may cause damage.

6.1 PUMP DISASSEMBLY

The pump is situated on machine bottom. The duration depends on the amount of daily work and the quality of water.

WHEN TO REPLACE THE PUMP

- 1 During delivery, no water comes out of the unit.
- 2 In case the machine remains inactive for too long, the pump does not deliver owing to oxidation of fittings.
- 3 Continuous overheating even in the presence of water.

If the pump needs to be removed, it is necessary to:

- 1 Remove the side and rear panels.

- 2 Release the pump from its seat by loosening the screws "A" of the bottom panel with a Phillips screwdriver.

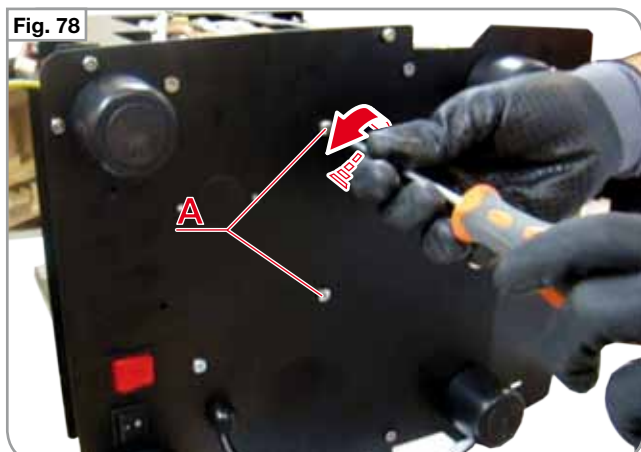
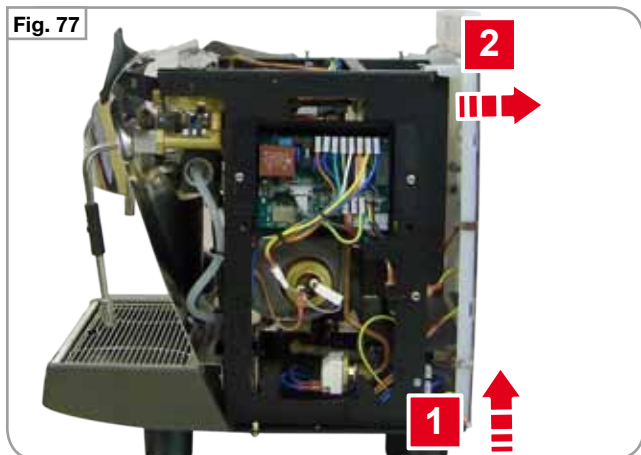

- 3 Disconnect the hydraulic connections of the pump:
- From the flowmeter, disconnect the Teflon pipe "B".
- From the pump to the heater, unscrew the fitting "C" using a 13 mm spanner.
- 4 Disconnect the electrical connections of the pump using the tweezers:
- A:** temperature probe.
B: power supply.
- 5 Take the pump out of the machine.

NOTE

Check the water inlet filter situated in the heater connection and replace it, if necessary.

NOTE

When replacing the pump, replace the O-ring code No. 02280007.V, too (see tables at the end of the manual).

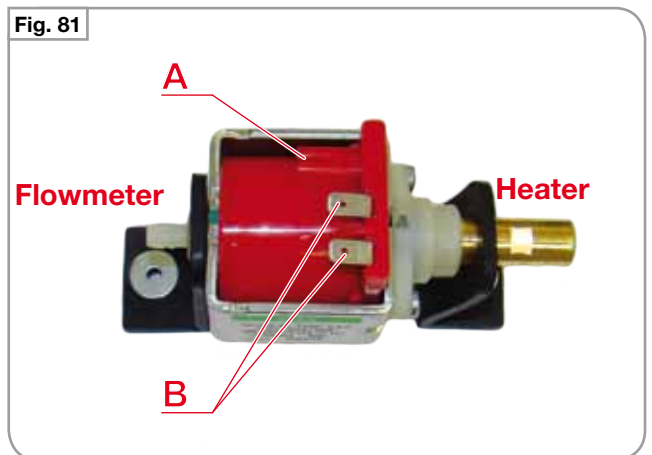
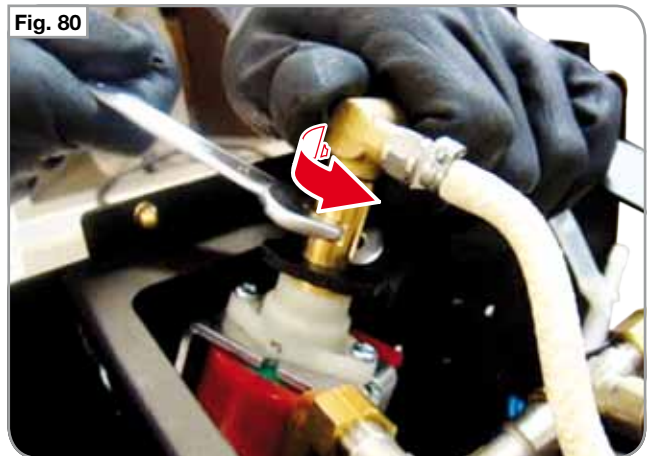
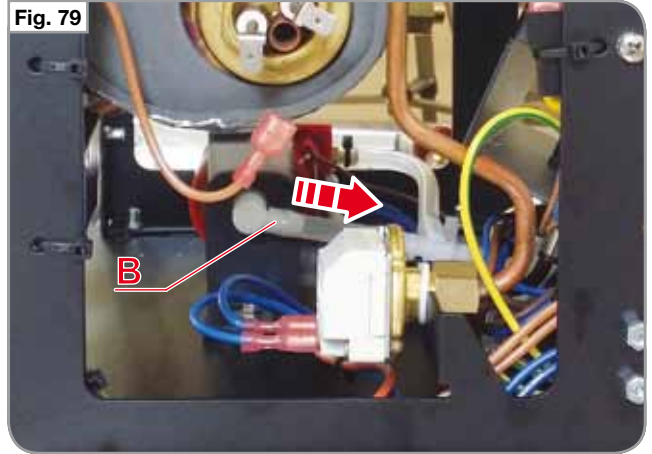

6.2 REPLACING THE COFFEE VALVE

The coffee valve "A" is situated underneath the upper panel, on the left side, and regulates the amount of water flowing inside the heater during all phases of machine operation.

WHEN TO INTERVENE

- 1 The system detects the absence of water and the pump is set off but the pump sounds like it's straining badly: the valve is stuck.
- 2 There is a general short circuit: the coil may be short-circuited due to micro leaks or electrical shock.
- 3 The heater flooded: the impurities have prevented the valve from closing properly.

HOW TO REPLACE THE COFFEE VALVE

To remove the coffee valve, it is necessary to:

- 1 Disconnect power connections using tweezers.
- 2 Using a 14 mm wrench, remove the bolt "B" that holds the coil in place and ease it out of its housing. Under optimal conditions, the removal is immediate but if parts are blocked, force removal as much as possible.

Fig. 82

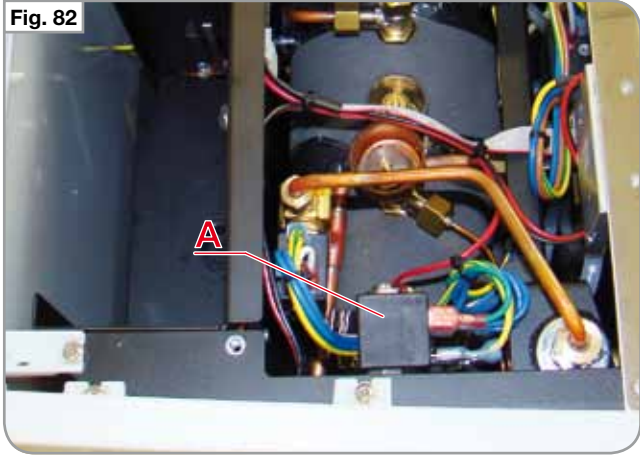

Fig. 83

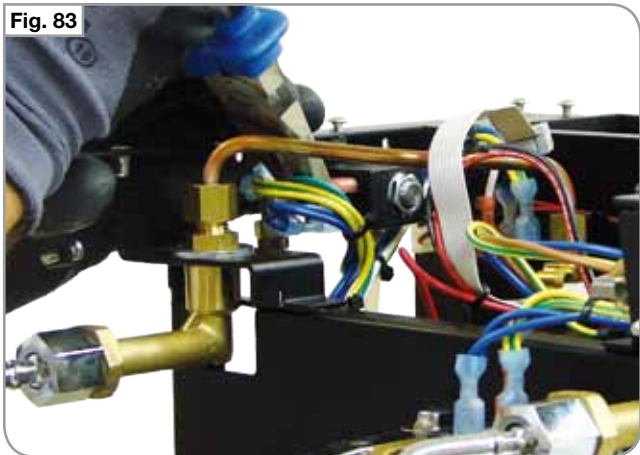
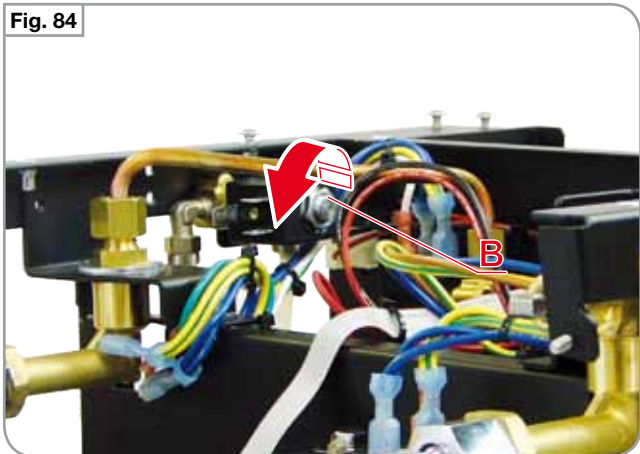
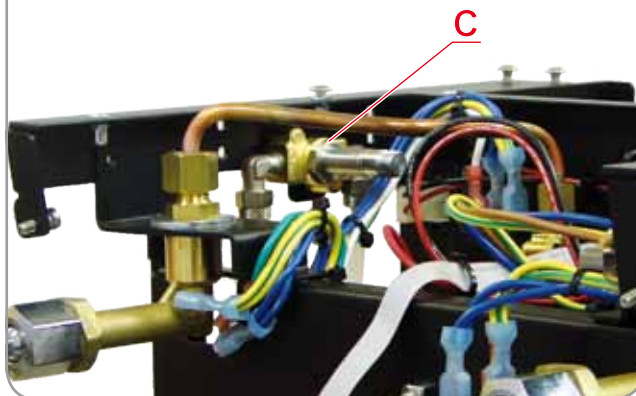

Fig. 84



- 3 Using a 24 mm wrench, remove the fixed part "C".

Fig. 85



- 4 Disconnect the hydraulic connections "D" by using a 12 mm wrench.
- 5 Loosen the locking screws "E" to release the valve from the machine frame.

Fig. 86

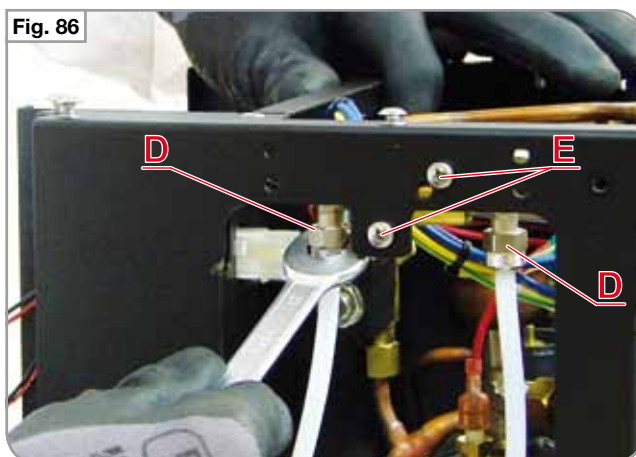

- 6 Make sure the plunger is clean and there are no obstructions. Replace the valve if it is not working.

Fig. 87



6.3 FLOWMETER

The issues related to flowmeter are those arising when dosing coffee, therefore only when the pre-set dosage buttons are used.

WHEN TO INTERVENE

The most common errors that you may encounter are:

- 1 Wires disconnected accidentally or unintentionally (e.g. after replacing a card).
- 2 There are impurities in the filter at the entrance of the fan.
- 3 The coil of the magnetic sensor has deteriorated and no longer reads the values correctly.
- 4 Dispensed coffee doses other than the set ones.

If one of these cases occurs, pressing one of the buttons with pre-set the machine does not make coffee and never stops (obstruction to the limit), or it can happen that the delivery does not stop or will not start as planned.

Moreover, the key pressed with pre-set will remain lit, while the continuous / stop key will flash to highlight a malfunction.

Even if the pre-sets do not work, the machine will always operate in semi-automatic mode using only the start/stop button until the arrival of the technician.



To verify that the flowmeter is effectively locked, you can:

- 1 Check function by measuring the voltage supplied to the control unit during a delivery.
- 2 Inspect the flowmeter directly.

HOW TO CHECK THE FLOWMETER

To measure the signal, it is necessary to access the electronic board located on the right side.

- 1 Remove the right, side panel.
- 2 With a multimeter measure the voltage alternating between the ends of the faulty dispenser (see figure). Place the test leads of the voltmeter at the terminals of the doser using the references in the image.

The signal generated by the fan is a square wave of about 5 V.

In case of damage, the voltage value will be 0 V.

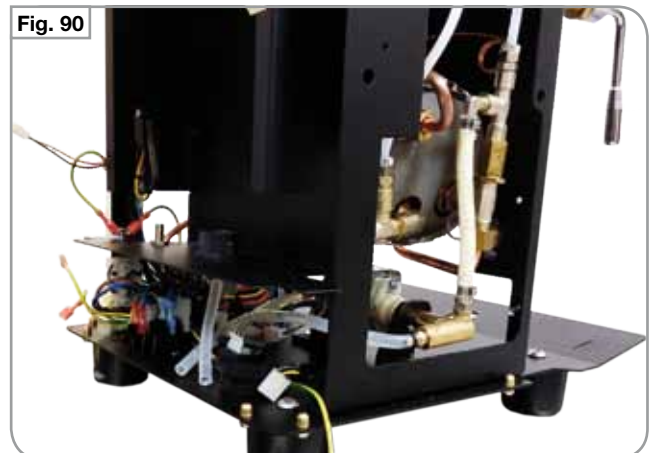

HOW TO REMOVE THE FLOWMETER

Access the machine rear side to inspect the flowmeter.

- 1 Remove the rear panel and the water tank.
- 2 Disconnect the Teflon pipes and electrical connections.

- 3 Slightly tilt the machine to the right side (front view) and remove the flowmeter by pushing from the bottom up.

NOTE

It is advisable to use an absorbent cloth when tilting the machine to prevent any water leakage.

- 4 Open the flowmeter by rotating the upper part and the lower one in reverse direction. Check for the presence of limescale in the flowmeter and verify the conditions of coil (bottom part) and magnets (upper part). If necessary, replace the flowmeter.
- 5 To re-assemble the flowmeter, refer to arrows printed on the part:
 - **IN:** bottom part, water inlet from the tank/waterline.
 - **OUT:** upper part, water outlet towards the pump.

6.4 HOT WATER VALVE

WHEN TO INTERVENE

The following problems may occur:

- 1 Failure to deliver water.
- 2 Continuous dripping.
- 3 Erroneous programming.

Cases **1** and **2** are due to malfunction of the valves so you need to access them and verify that they are working properly.

The valve may stop operating due to electrical problems or is not working properly due to obstructions for example caused by pieces of limescale that detach from the heater and clog the valve.

If replacement is not helpful, there could be a problem with the relay in the electronic board, therefore it is necessary to directly measure the voltage with a voltmeter while water is being dispensed.

Position the tip in correspondence of the connector shown by the figure to measure voltage.

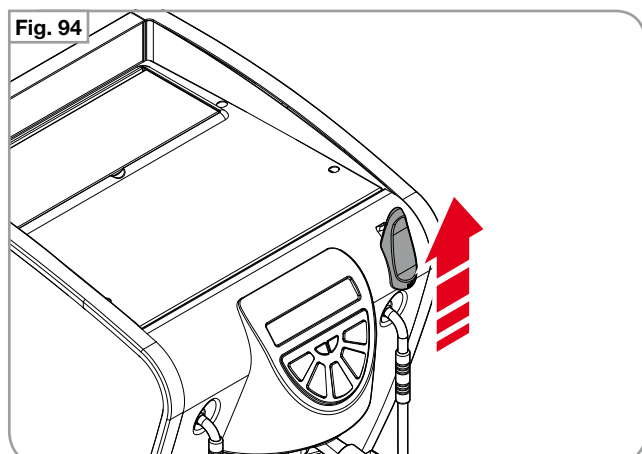

HOW TO ACCESS THE VALVE

To safely access the valve, it is necessary to:

- 1 Open the steam valve to let steam out completely.

WARNING

Totally discharge pressure inside the heater. It is not possible to operate with pressure in the heater.

- 2 Disconnect power connections using tweezers.



- 3 Remove the inner rear panel (tank housing) by loosening the 4 screws "A" using a Phillips screwdriver.

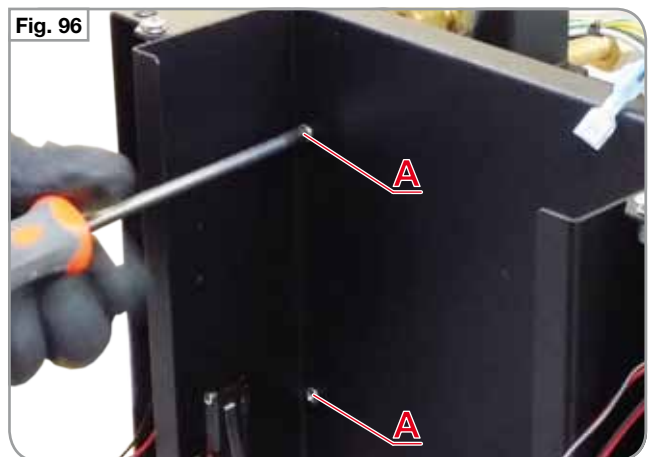

- 4 Remove the locking nut "B" using a 14 mm wrench and take the electrovalve out.



- 5 Unscrew the fitting "C" using 2 wrenches. The fitting has two digits useful for reassembly:
1= water inlet
2= water outlet.

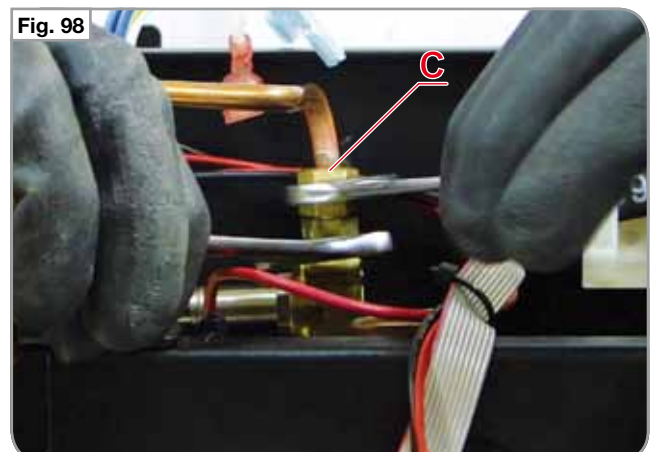

- 6 Check the spring is working properly and that the inner cylinder is clean. Replace the valve completely, if there is nothing visible that affects its use.

Fig. 99



6.4.1 DISASSEMBLY OF HOT WATER NOZZLE

To reassemble the hot water nozzle, proceed as follows:

- 1 Remove the front panel (see paragraph 3.5).
- 2 Loosen the locking nut "A" using a 22 mm wrench and take the nozzle out.

Fig. 100

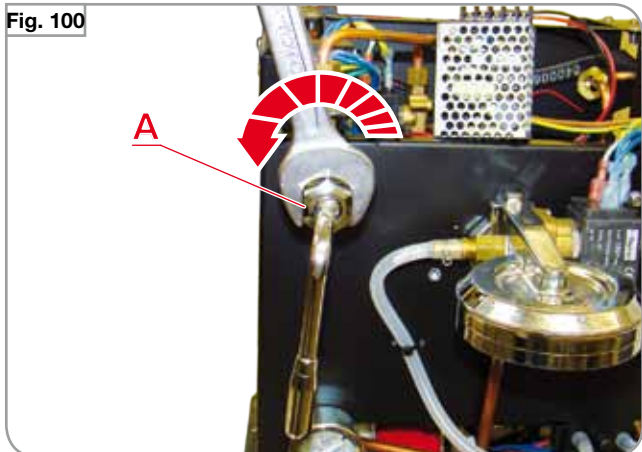

6.5 STEAM NOZZLE

The steam nozzle is composed of a piston actuated by the knob, which presses on a nut with spring return. By pressing against the spring it creates space for the steam to pass.

We suggest to replace the seals that keep the piston perfectly aligned, every 4-6 months. Every year it is advisable to replace the nut to prevent the gasket that insulates the steam from drying and letting steam pass. Since these parts must be changed, we suggest replacing all the seals simultaneously.

WHEN TO INTERVENE

Problems related to the steam nozzle are:

- Continuous loss of steam.
- Water dripping from the steam nozzle.
- Delayed closure.
- Steam lever too loose.

DANGER

Before proceeding with the operations described in the chapter make sure that the machine is turned off and unplugged from the mains. Discharge any residual pressure present in the steam heater.

Fig. 101

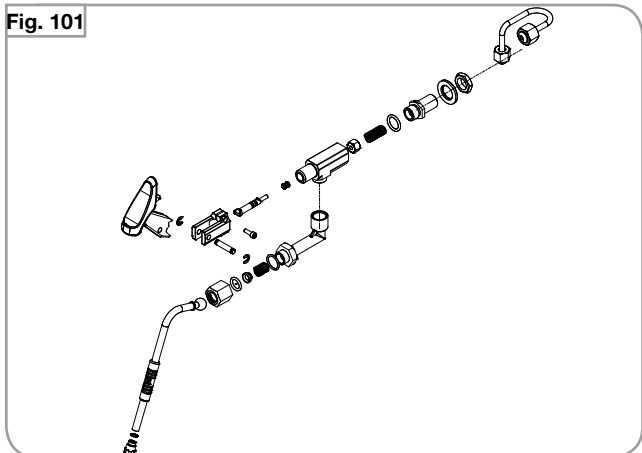
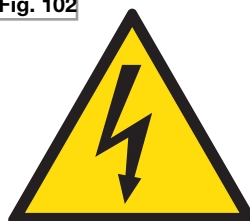

Fig. 102



DANGER

If there is a loss of vapor or condensation, it is necessary to:

- 1 Turn the machine off, let out all the steam until there is no pressure in the heater.
- 2 Remove the left side panel and the front one.

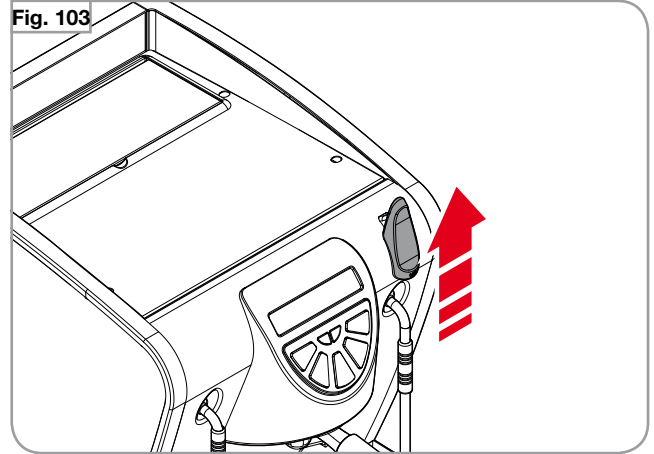

- 3 Loosen the steam nozzle by means of the nut "A" using a 22 mm wrench, by levering the nozzle locking nut with a 23 mm wrench, as shown on the figure.

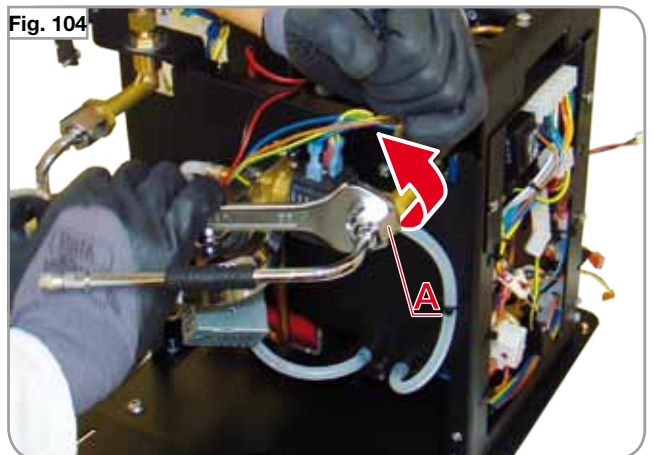

- 4 Loosen the steam pipe fitting of the nozzle by means of a 20 mm wrench, by levering the locking nut with a 23 mm wrench, as shown on the figure.



- 5 Unscrew the locking nut of the steam nozzle with a 23 mm wrench, by levering the steam valve block with a 22 mm wrench.

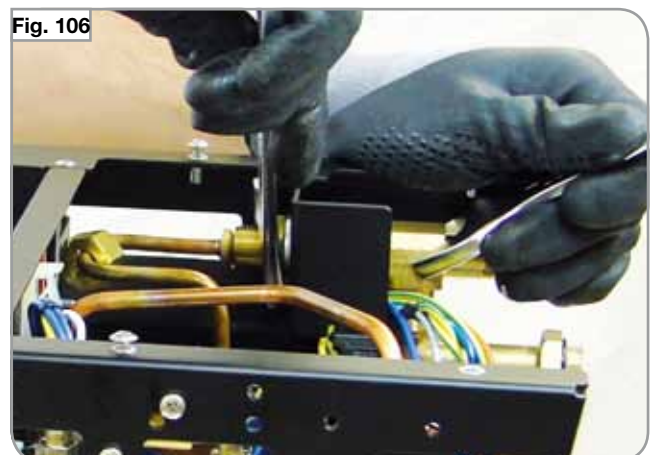

DISASSEMBLY OF THE STEAM LEVER

- 1 Remove the machine front panel. Unlike the nozzle, the lever is extracted together with the panel.
 - 2 Remove the Seeger ring "A" using the pliers.
 - 3 Remove the piston "B" from the opposite side.
-
- 4 Take out the support of the lever "C" to release the steam lever "D".
-
- 5 To remove the dispensing nozzle it is sufficient to unscrew the lower part of the nozzle by hand.

Fig. 107

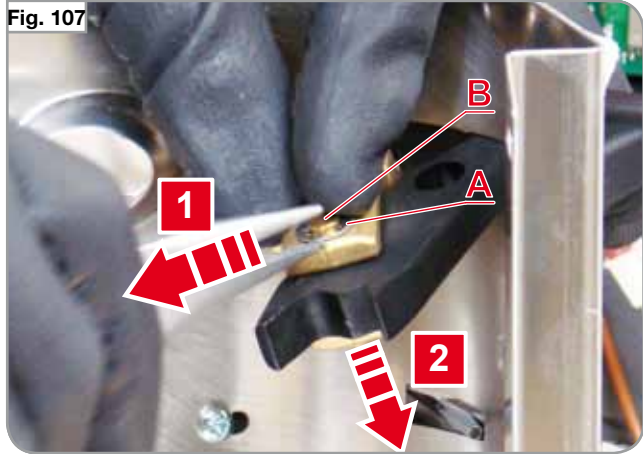

Fig. 108

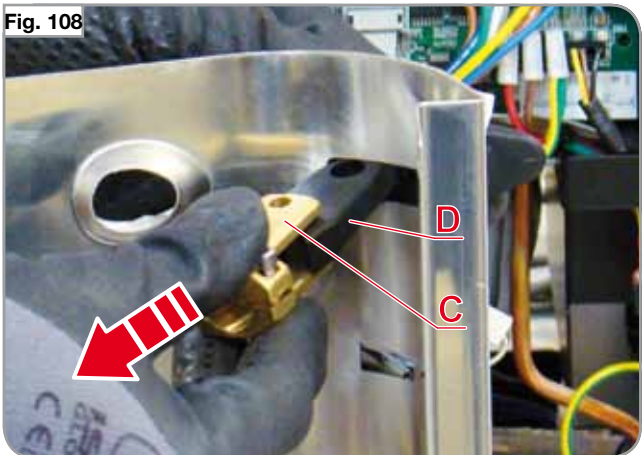

Fig. 109

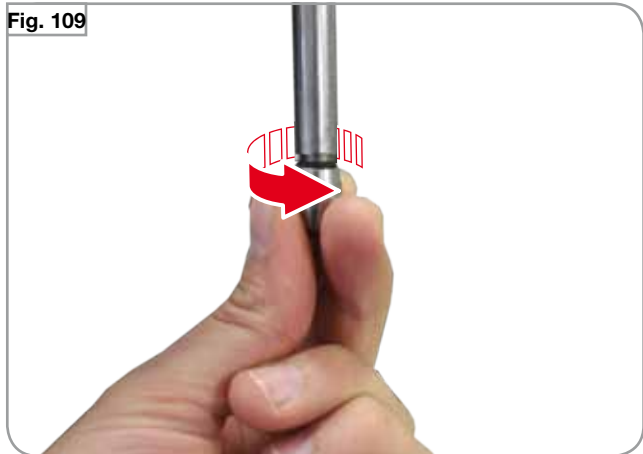

Fig. 110



MAINTENANCE OF STEAM NOZZLE

To carry out repairs and maintenance once the steam nozzle is removed we can proceed with the following steps:

- 1 Remove the piston which is actuated by the lever. The seals that make it slide in its housing tend to wear out and must be replaced depending on the use or every 4-6 months.

- 2 Using a 22 mm wrench remove the steam nozzle from its housing. We recommend replacing the seal at least once a year.

Fig. 111

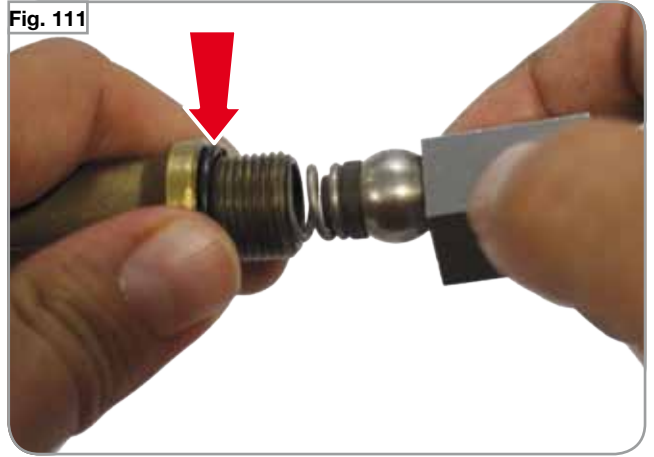

- 3 Unscrew the fitting "A" with a 21 mm wrench to reach the spring.
We recommend replacing the seal at least once a year.
- 4 Remove the steam piston "C" behind the spring "B". We recommend replacing the piston at least once a year.

Fig. 112

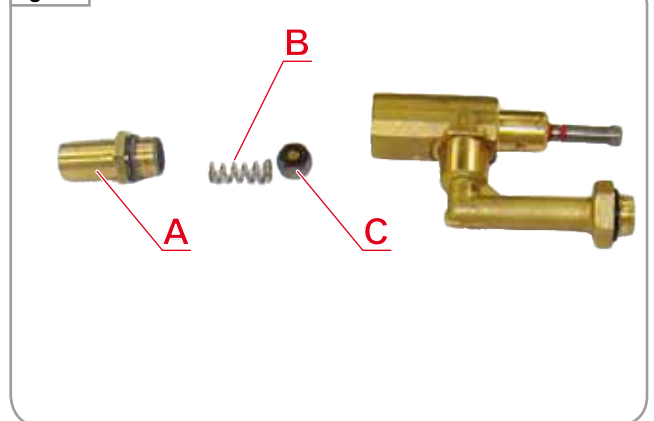

The steam nozzle, in its simplicity, has components that must be replaced due to wear.

It is recommended to replace:

- The piston seals (code No. 02280014) to avoid misalignment.
- The seals of the lever block (02280011) and the connection to the heater.
- The piston of inner closure (98008004).

Fig. 113

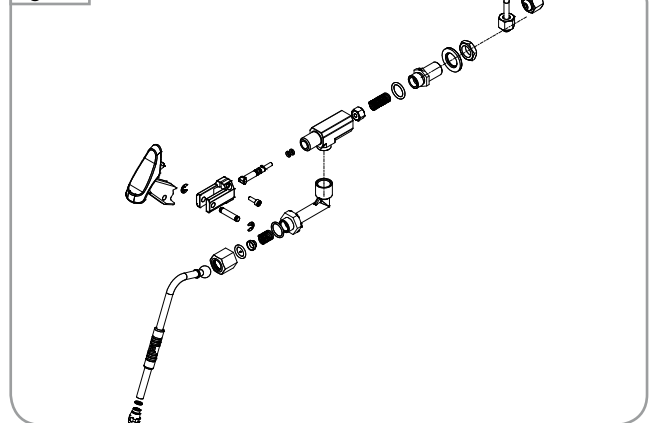

RE-ASSEMBLY OF THE STEAM NOZZLE

During the reassembly phase it is important to lubricate the seals of the piston in contact with the lever, to ensure fluid movement inside the housing.

Fig. 114



WARNING

Operation to be performed when the machine is on.

When fixing the screw that holds the lever on the steam nozzle it is necessary to:

- 1 Lightly press the lever upwards to let steam come out.
- 2 Release the lever until the steam supply stops.
- 3 Tighten the lever locking screw on the steam nozzle.

In this way, there is a precise calibration of the steam nozzle.



6.6 WATER TANK

To access the water tank, remove the rear panel.

NOTE

In case of a prolonged inactivity of the machine, the tank valve may be blocked owing to limescale.

To release the tank valve, use a screwdriver to allow water discharge.

Check the valve for the presence of limescale and the conditions of seal "A". Replace the faulty parts, if necessary.

6.6.1 REPLACEMENT OF THE FLOAT

- 1 Take out the water tank and remove the rear panel.
- 2 Manually remove the tank float.

NOTE

During the assembly phase of the new float, make sure the "+" mark on the float itself is oriented towards the tank bottom.

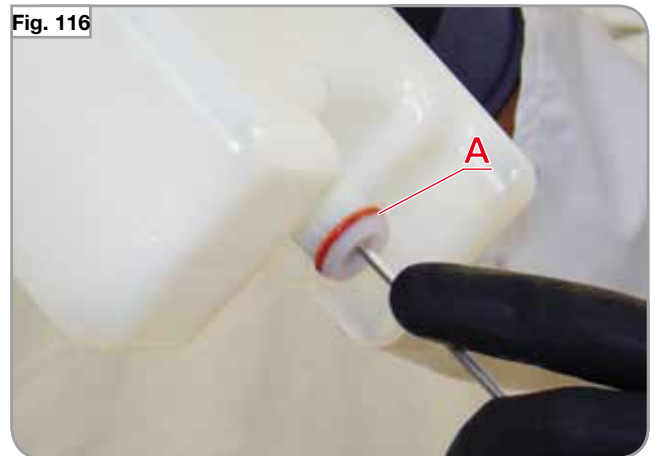

6.6.2 REMOVAL OF THE MAGNETIC SENSOR

This sensor serves to detect the presence of water inside the tank. In case of breakdown or malfunctioning, it can be replaced.

- 1 Take out the water tank from its housing and remove the rear panel.
- 2 Unscrew the sensor "A" with a wrench, holding the locking nut with pliers.

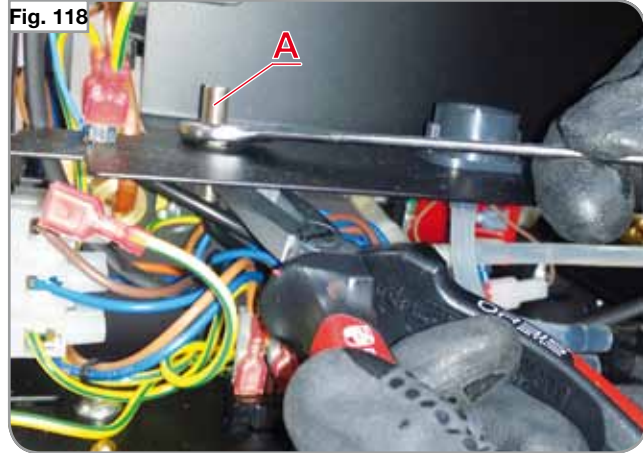

6.6.3 REMOVAL OF THE TANK MICROSWITCH

To remove the tank-detecting microswitch, proceed as follows:

- 1 Take out the water tank and remove the rear panel.
- 2 Disconnect the electrical connections.

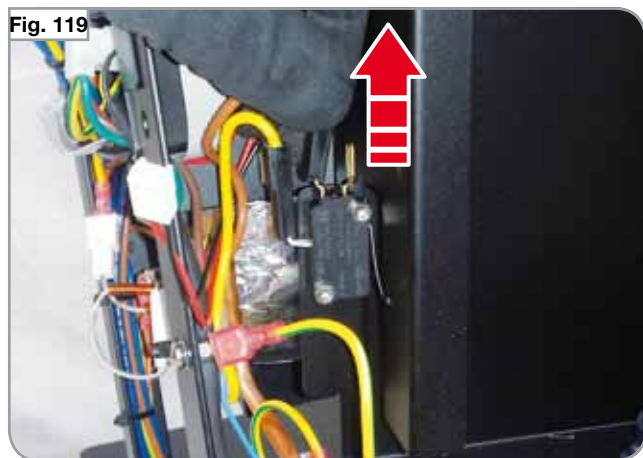

- 3 Loosen the locking screws of the microswitch using a 2,5 mm Allen key.



6.7 REMOVAL OF THE PRESSURE SWITCH

The pressure switch cuts off the circuit powering the heating element. Therefore, it will read a voltage as the one of mains when heater pressure is enough, while will read 0V when the heating element is warming up.

To remove the pressure switch "A", it is necessary to:

- 1 Remove the right, side panel.
- 2 Disconnect the electrical connections.
- 3 Unscrew the fitting "B" with a 17 mm wrench, by levering the pressure switch-locking nut "C" with a 15 mm wrench.

Fig. 121

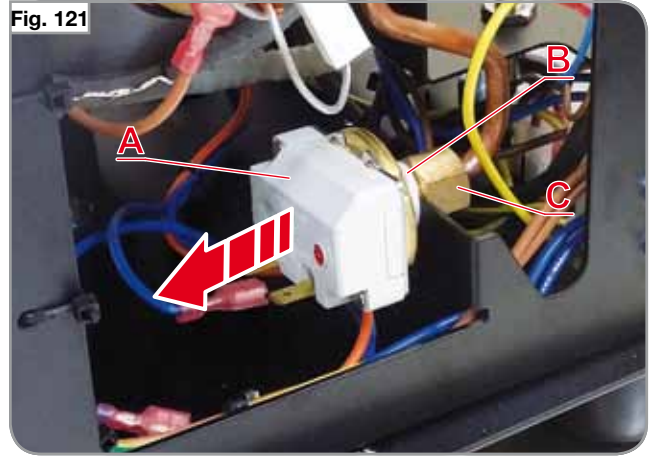
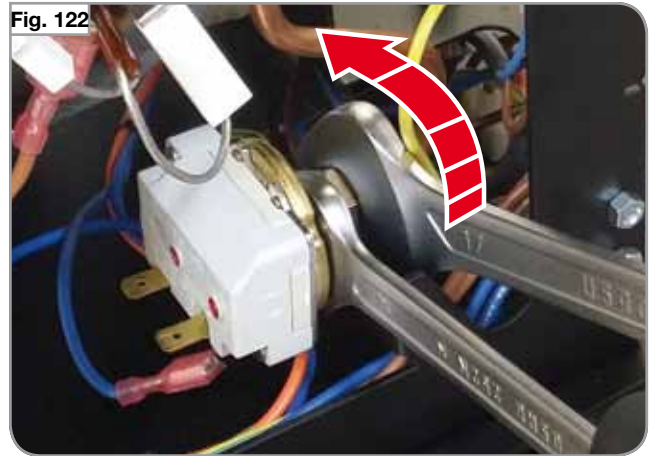
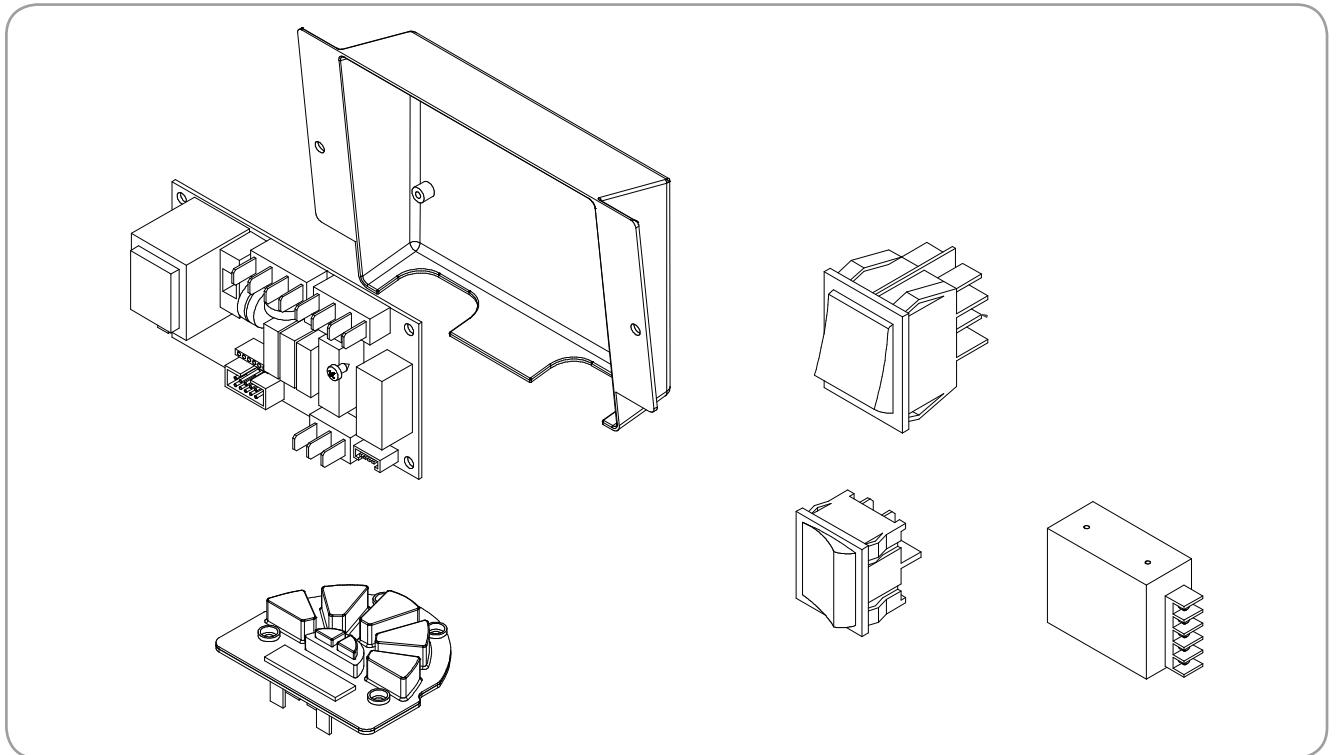

Fig. 122



7. ELECTRIC COMPONENTS



INDEX

7. ELECTRIC COMPONENTS	7.1
7.1 CONTROL UNIT	7.2

TOOLS NEEDED:



7.1 CONTROL UNIT

To access the main board it is necessary to:

- 1 Remove the right, side panel.
- 2 Disconnect the electrical connections using the pliers.
- 3 Unscrew the two screws "A" with a Phillips screwdriver and remove the board support with the board inside.
- 4 Loosen the board locking screws "B" on the support using a Phillips screwdriver.

Fig. 123

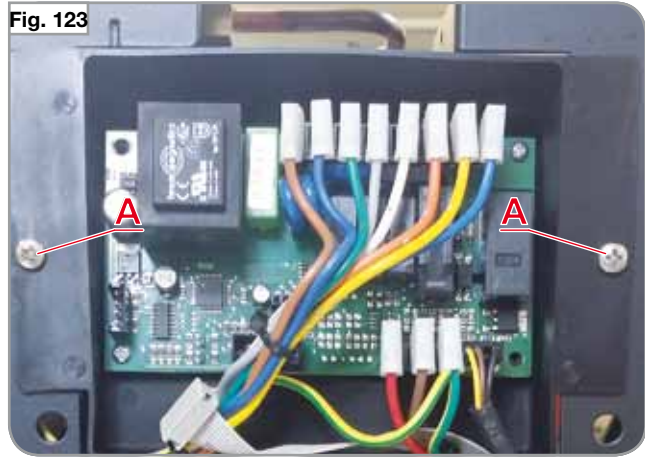

Fig. 124



The control unit without connections appears as shown in the figure.

- 1 Serial port
- 2 Keyboard serial port
- 3 Sensor connectors:
 - 3a level
 - 3b pressure
 - 3c negative pole
- 4 Power supply:
 - 4a negative pole
 - 4b pulses
 - 4c power supply
- 5 Connectors:
 - 5a Pressure switch
 - 5b heating element
 - 5c pump
 - 5d steam / H2O
- 6 Connectors:
 - 6a delivery electrovalve
 - 6b level electrovalve
 - 6c neutral
 - 6d phase

Fig. 125

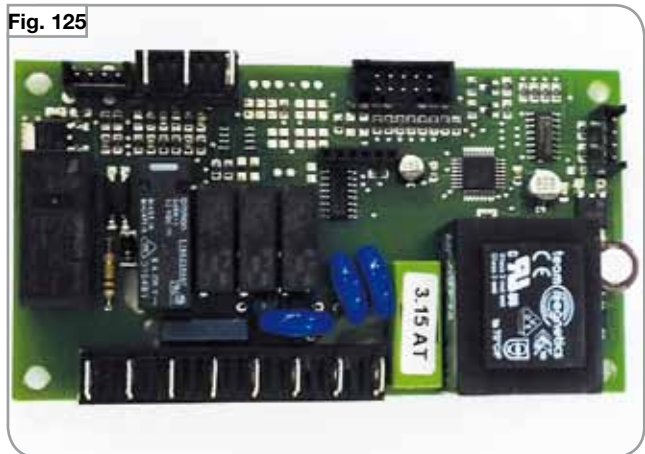
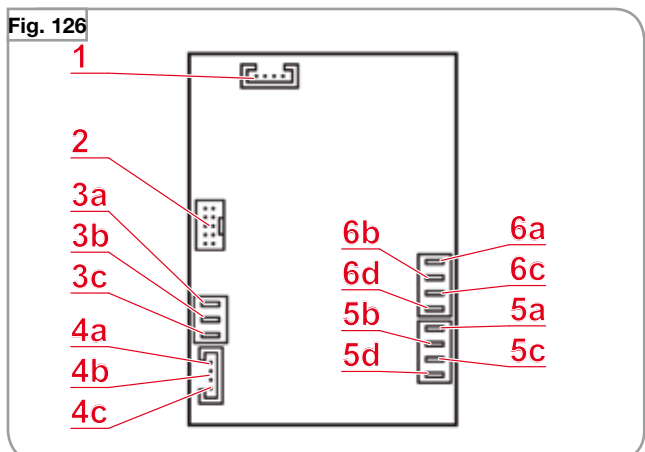
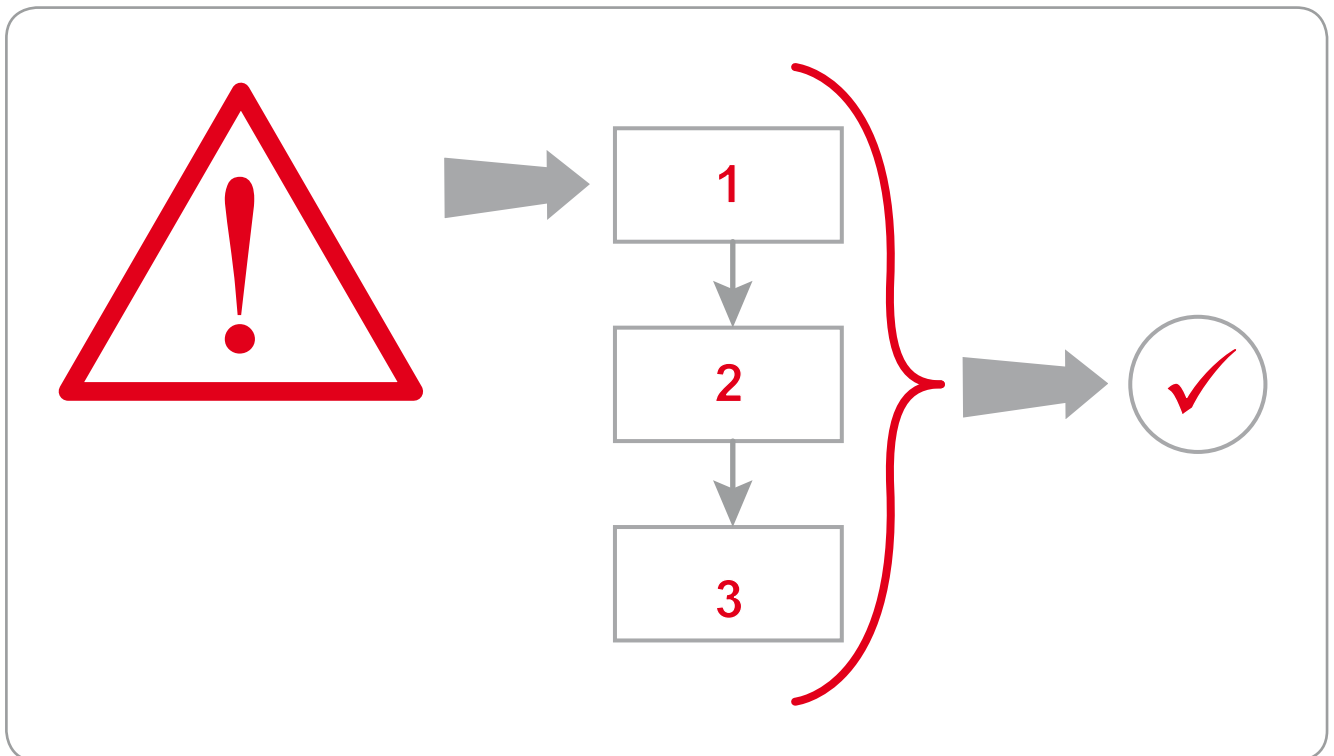

Fig. 126



8. TROUBLESHOOTING



INDEX

8. TROUBLESHOOTING.....	8.1
8.1 WATER LACK LIGHT	8.2
8.2 HEATING ELEMENT LIGHT	8.3
8.3 REMOVAL OF KEYBOARD.....	8.4
8.4 LIGHTS (LUX VERSIONS)	8.5
8.5 COFFEE DELIVERY	8.6
8.6 WATER DELIVERY	8.7
8.7 STEAM DELIVERY	8.8
8.8 HEATER	8.9

8.1 WATER LACK LIGHT

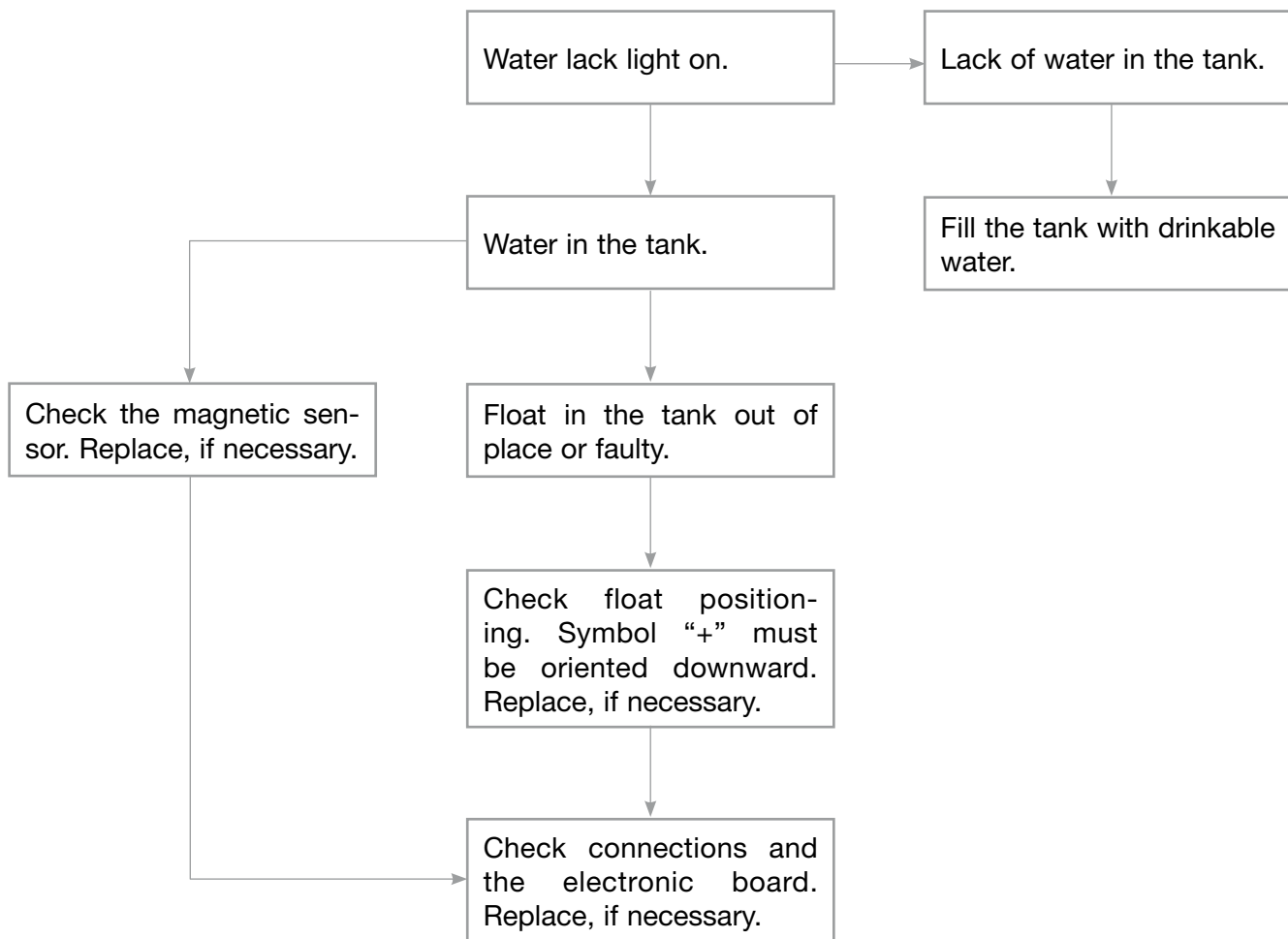

8.2 HEATING ELEMENT LIGHT

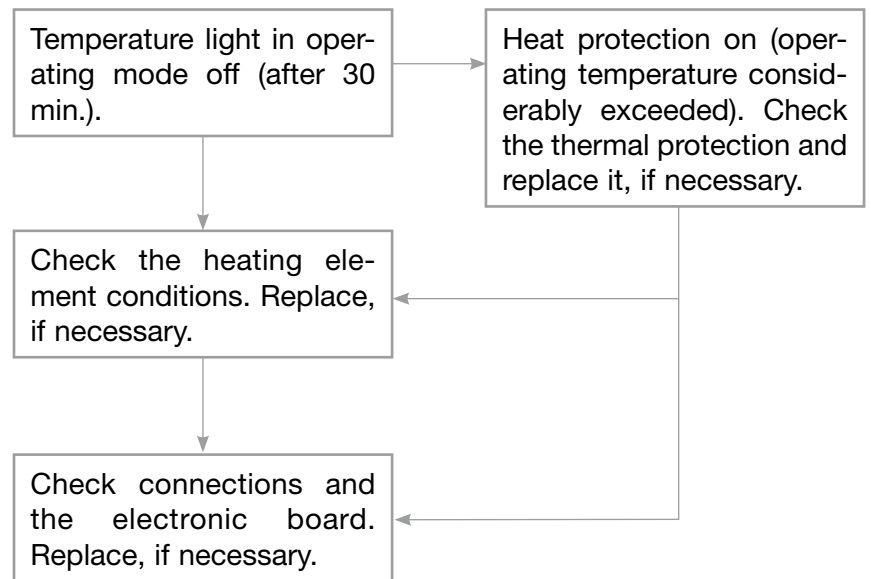

8.3 REMOVAL OF KEYBOARD

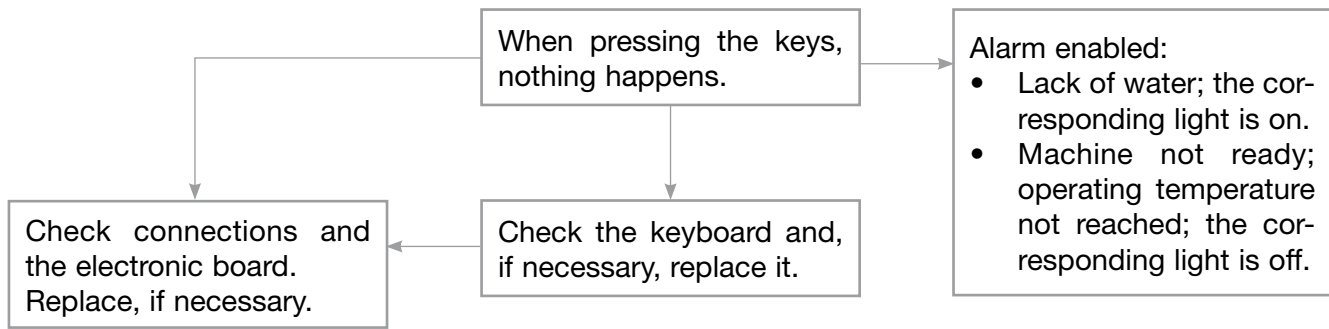

8.4 LIGHTS (LUX VERSIONS)

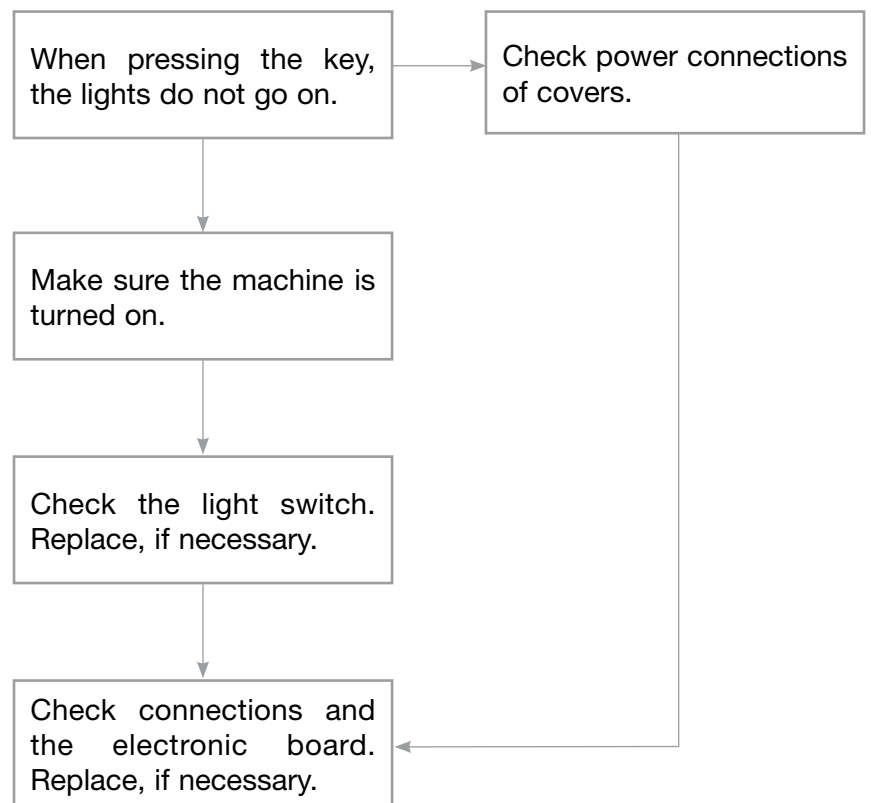

8.5 COFFEE DELIVERY

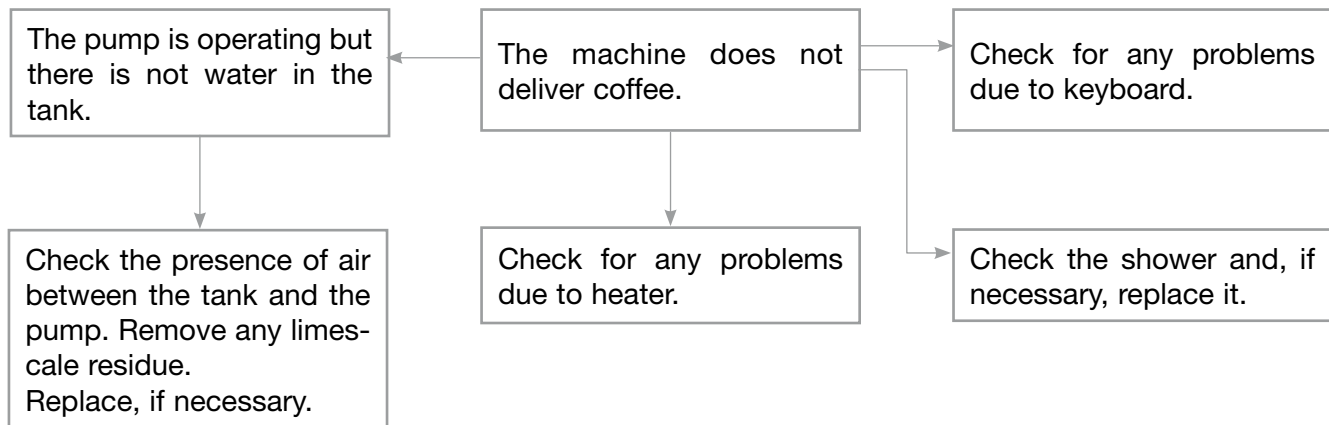

8.6 WATER DELIVERY

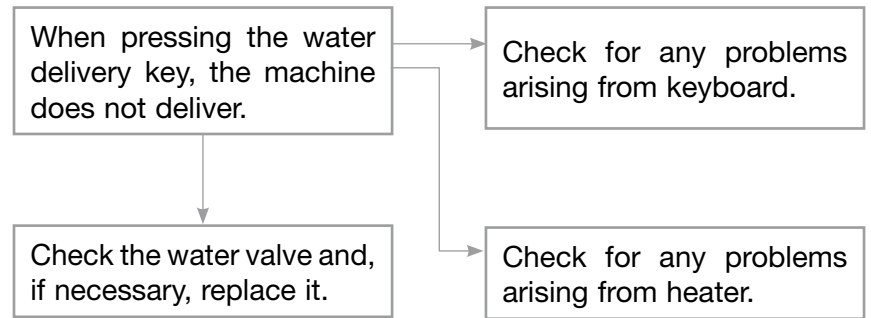

8.7 STEAM DELIVERY

When pressing the steam lever, the machine does not deliver.

Check for any problem arising from heater warming up.

Check the steam nozzle. Remove any limescale residue. Replace, if necessary.

8.8 HEATER

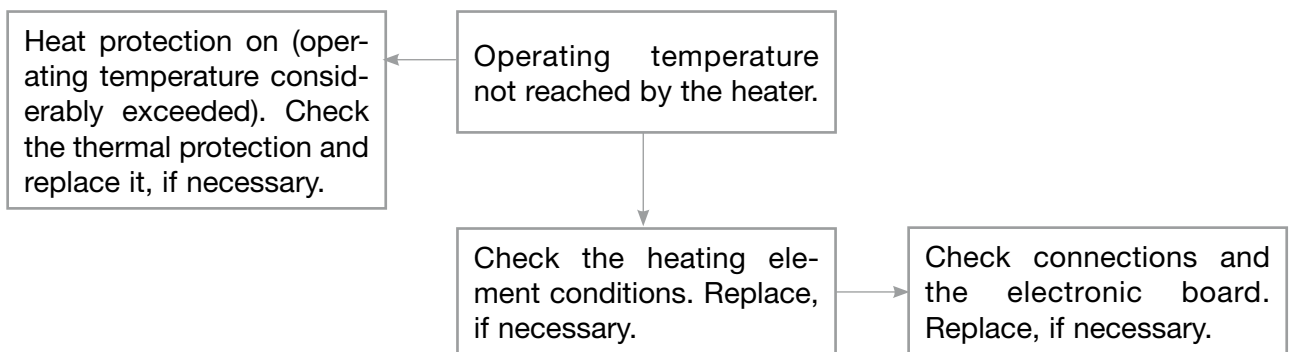
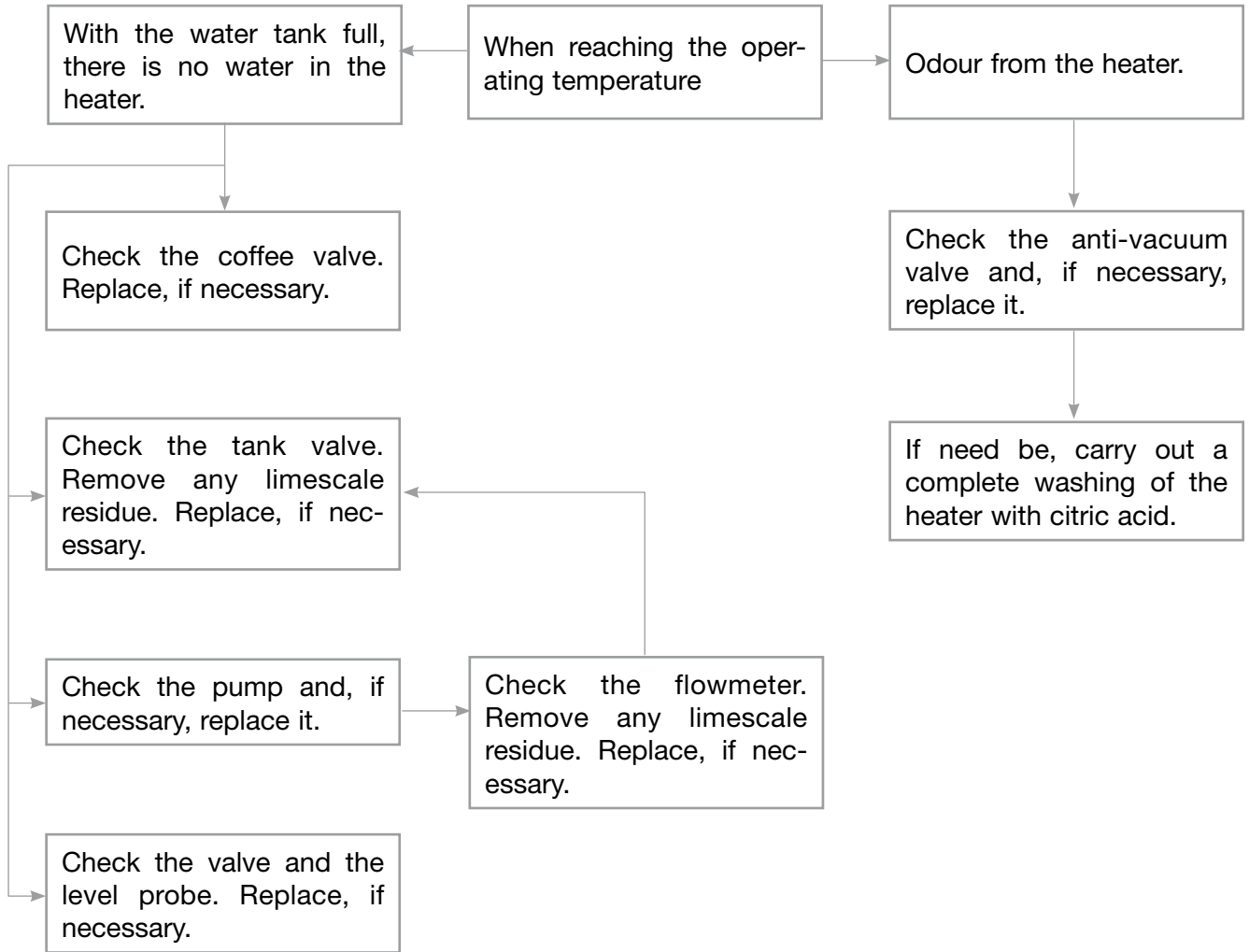

9. DIAGRAMS

9.1 HYDRAULIC DIAGRAM TANK VERSION

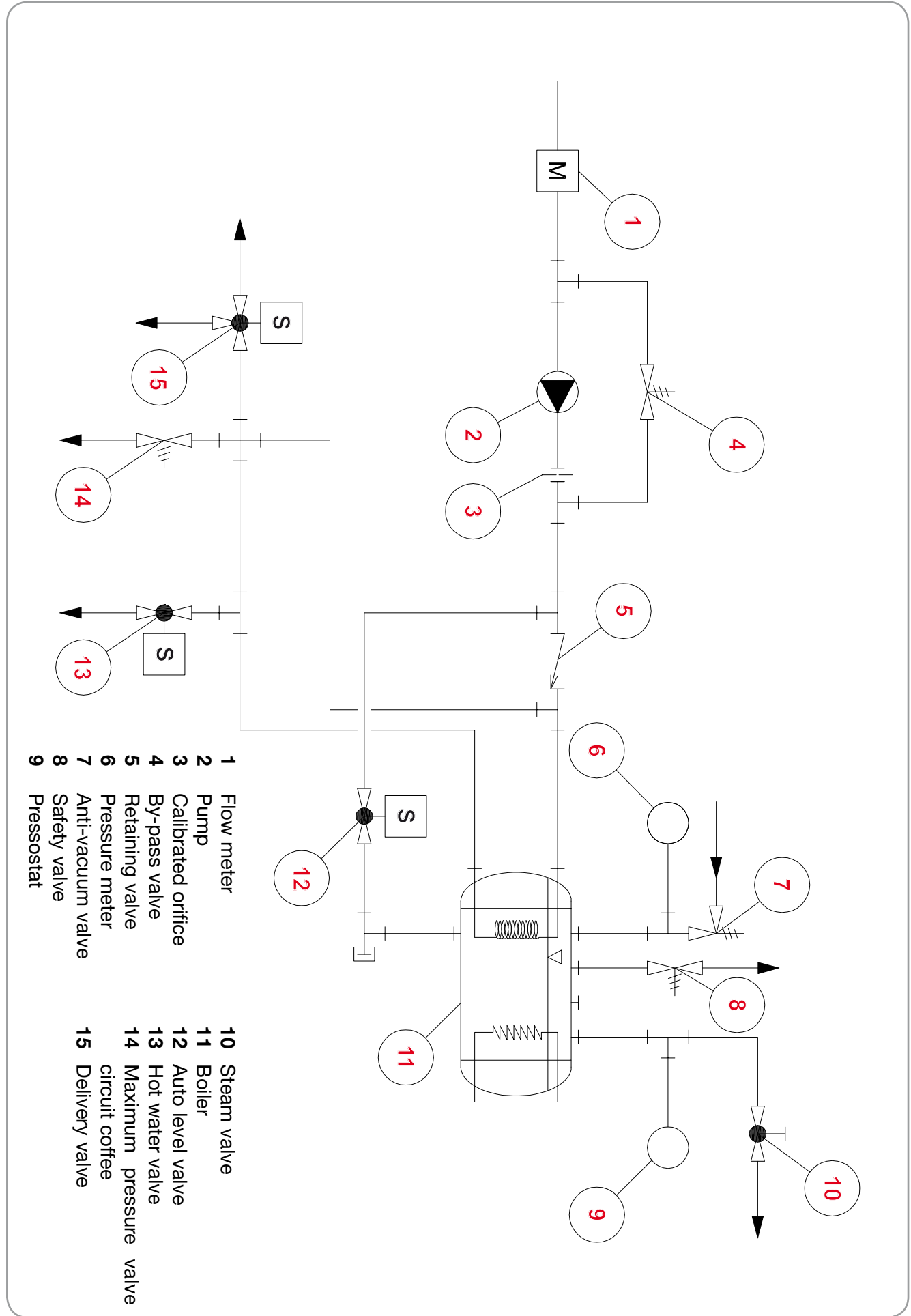

- | | | | |
|---|--------------------|----|------------------------|
| 1 | Flow meter | 10 | Steam valve |
| 2 | Pump | 11 | Boiler |
| 3 | Calibrated orifice | 12 | Auto level valve |
| 4 | By-pass valve | 13 | Hot water valve |
| 5 | Retaining valve | 14 | Maximum pressure valve |
| 6 | Pressure meter | 15 | Delivery valve |
| 7 | Anti-vacuum valve | | |
| 8 | Safety valve | | |
| 9 | Pressostat | | |

9.2 HYDRAULIC DIAGRAM DIRECT CONNECTION VERSION

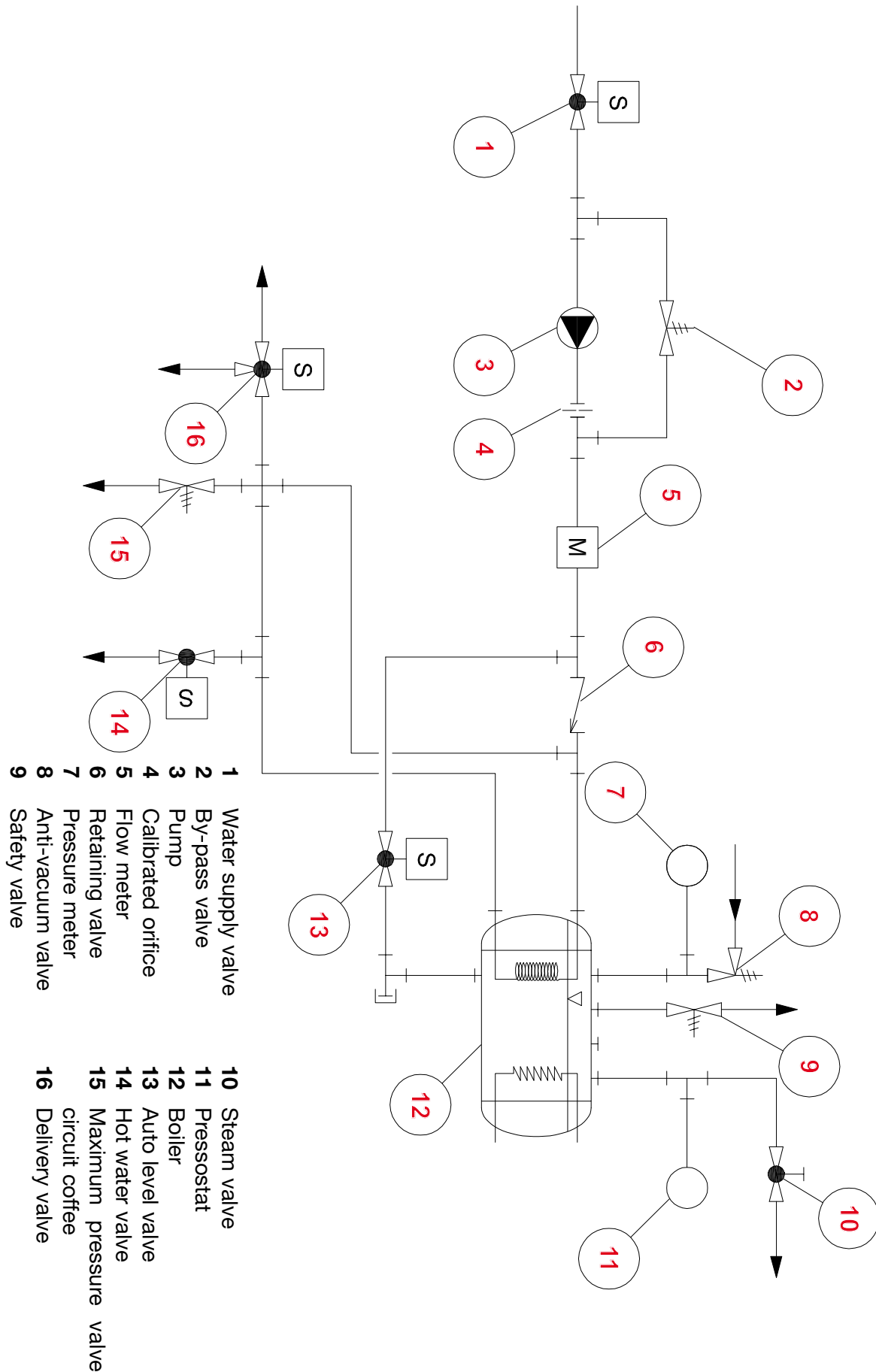

9.3 WIRING DIAGRAM TANK VERSION

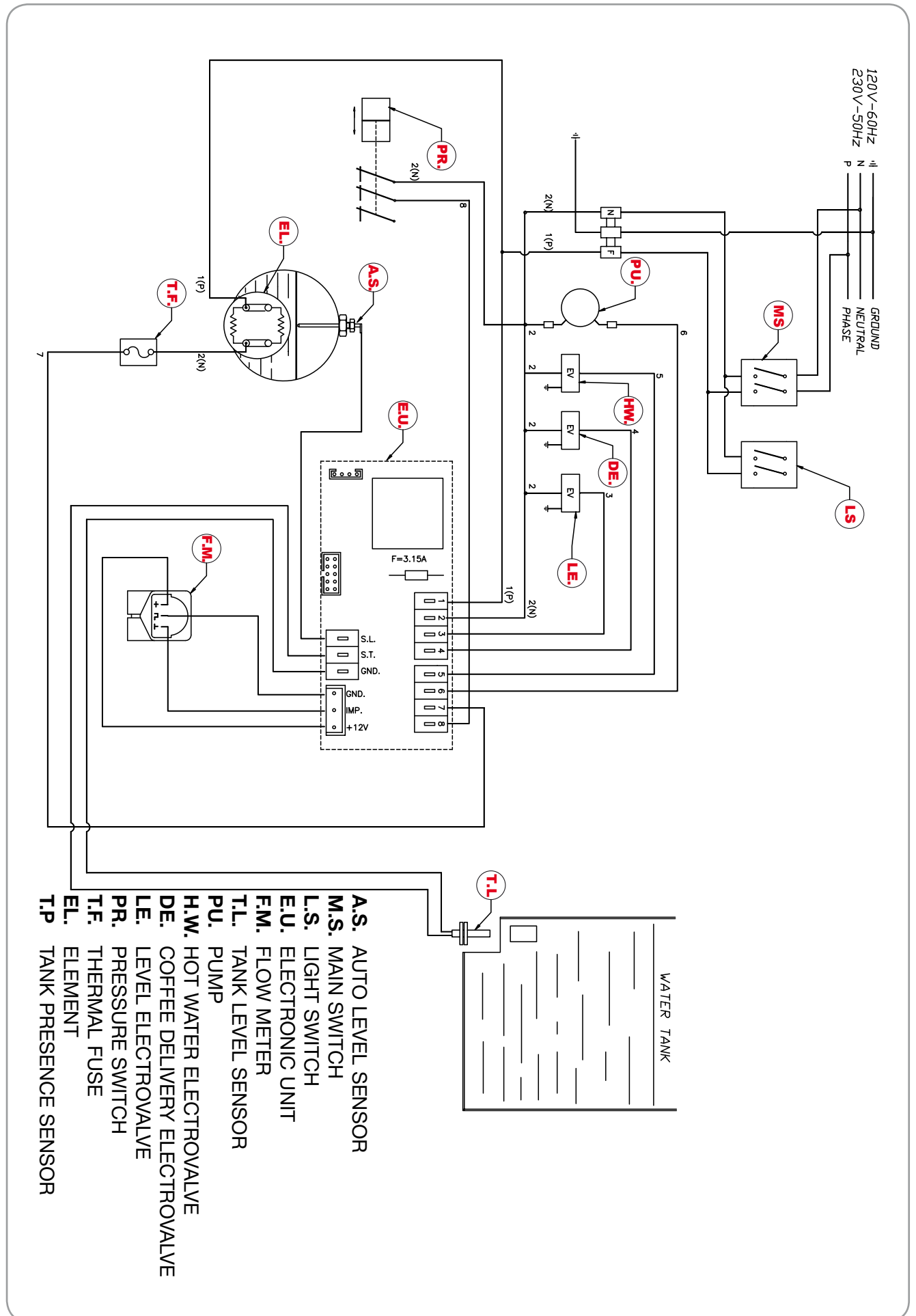

- A.S. AUTO LEVEL SENSOR
- M.S. MAIN SWITCH
- L.S. LIGHT SWITCH
- E.U. ELECTRONIC UNIT
- F.M. FLOW METER
- T.L. TANK LEVEL SENSOR
- P.U. PUMP
- H.W. HOT WATER ELECTROVALVE
- D.E. COFFEE DELIVERY ELECTROVALVE
- L.E. LEVEL ELECTROVALVE
- P.R. PRESSURE SWITCH
- T.F. THERMAL FUSE
- EL. ELEMENT
- T.P. TANK PRESENCE SENSOR

10. MAINTENANCE CHECKING



INDEX

10. MAINTENANCE CHECKING	10.1
10.1 DAILY MAINTENANCE	10.2
10.2 WEEKLY MAINTENANCE	10.2
10.3 YEARLY MAINTENANCE	10.3
10.4 BIENNIAL MAINTENANCE	10.4

10.1 DAILY MAINTENANCE

Time required 5 min:

- Clean the machine;
- Clean the unit with the blind filter and specific detergent (Pulycaff);
- Empty the water collection tray.

10.2 WEEKLY MAINTENANCE

Time required 10 min:

- Clean the machine;
- Clean the unit with the blind filter and specific detergent (Pulycaff);
- Empty the water collection tray;
- Remove the filter from its holder and thoroughly clean it;
- Immerse the filter holder into hot water with specific detergent (Pulycaff) and thoroughly clean all parts;
- Verify suitability of water used (total hardness $F^{\circ} < 6$).

10.3 YEARLY MAINTENANCE

Time required 45 - 60 min:

The skilled technician should take all the necessary precautions concerning safety measures to insulate the machine from the mains and to avoid pressure in the heater, waterline closure or tank removal so as to prevent inconveniences or damages. Before proceeding, remove all machine covers and check for any damage or leakage.

Before proceeding, remove all perimeter coverings and make sure there are no damages or leakages.

- Check for any sign of leakage;
- Check all wirings;
- Check pump noise;
- Check for any drip from the unit, the steam nozzle and the hot water nozzle;
- Check non-return valve;
- Check self-level function;
- Check heater pressure (_____Bar);
- Check the presence of limescale in the tank;
- Check total production of beverages;
- Check electrovalve for leakages;
- Check heater for leakages;
- Replace the group gasket (02280020.C);
- Replace shower screen (03000066);
- Insert or replace, if necessary, shims under the seal (02060014).

NOTES

The water hardness must be below 6°fr (French degree).

The chlorine content must not exceed 100 mg.

Necessary spare parts:

02280020.C

03000066

02060014

10.4 BIENNIAL MAINTENANCE

Time required 60 - 90 min:

The skilled technician should take all the necessary precautions concerning safety measures to insulate the machine from the mains and to avoid pressure in the heater, waterline closure or tank removal so as to prevent inconveniences or damages. Before proceeding, remove all machine covers and check for any damage or leakage.

- Check for any sign of leakage;
- Check all wirings;
- Check pump noise;
- Check for any drip from the unit, the steam nozzle and the hot water nozzle;
- Replace the non-return valve (01000023);
- Check self-level function;
- Check heater pressure (_____Bar);
- Check total production of beverages;
- Check electrovalve for leakages;
- Check heater for leakages;
- Replace group gasket (02280020.C);
- Replace shower screen (03000066);
- Insert or replace, if necessary, shims under the seal (02060014);
- Replace the pressure switch (09200014);
- Replace the steam nozzle seals (05000001);
- Replace the steam nozzle closing piston (98008004);
- Replace the 2-coffee filter (03000073);
- Replace the 1-coffee filter (03000072);
- Replace the steam nozzle support seal (02280037);
- Replace the nozzle support seal (02280011);
- Replace the steam lever piston seals (2 x 02280014);
- Replace the steam nozzle seal (02280036);
- Replace the unit expansion valve (98120001).

NOTES

**The water hardness must be below 6°fr (French degree).
The chlorine content must not exceed 100 mg.**

Necessary spare parts:

01000023
02280020.C
03000066
02060014
09200014
05000001
98008004
03000073
03000072
02280037
02280011
2x02280014
02280036
98120001

ANNUAL MAINTENANCE

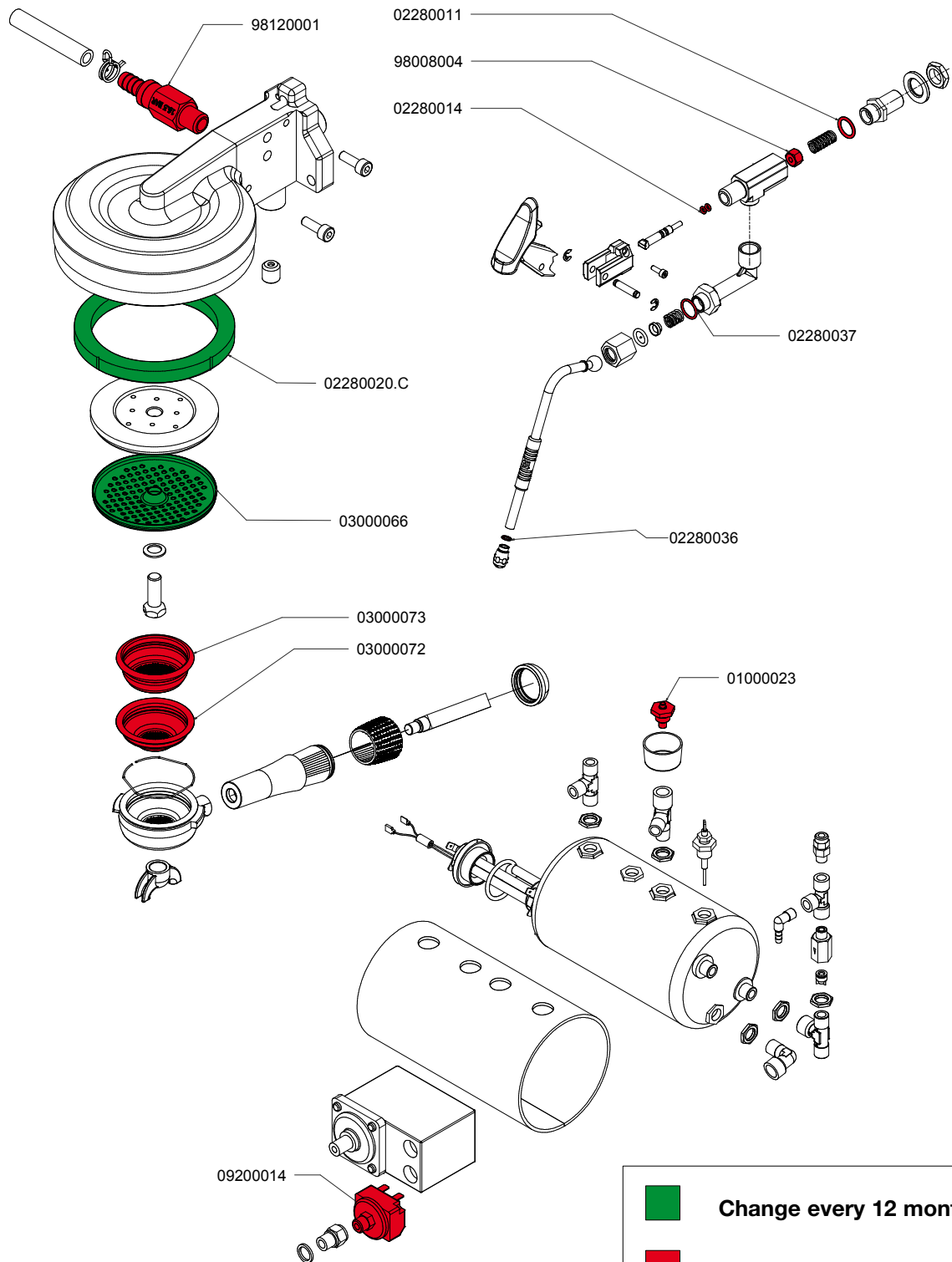

11.1 CABINET PARTS

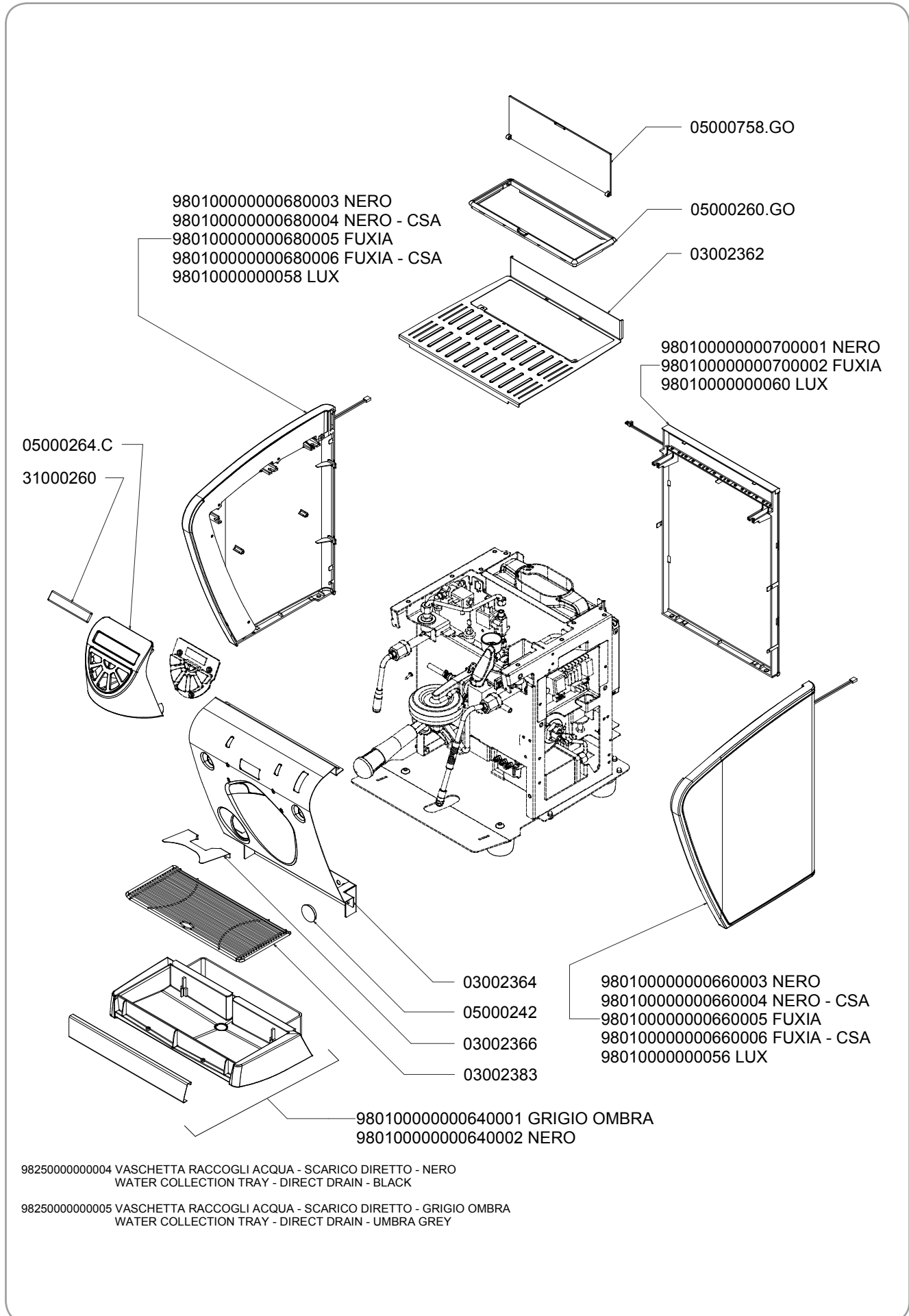

11.2 COMPLETE POURING UNIT

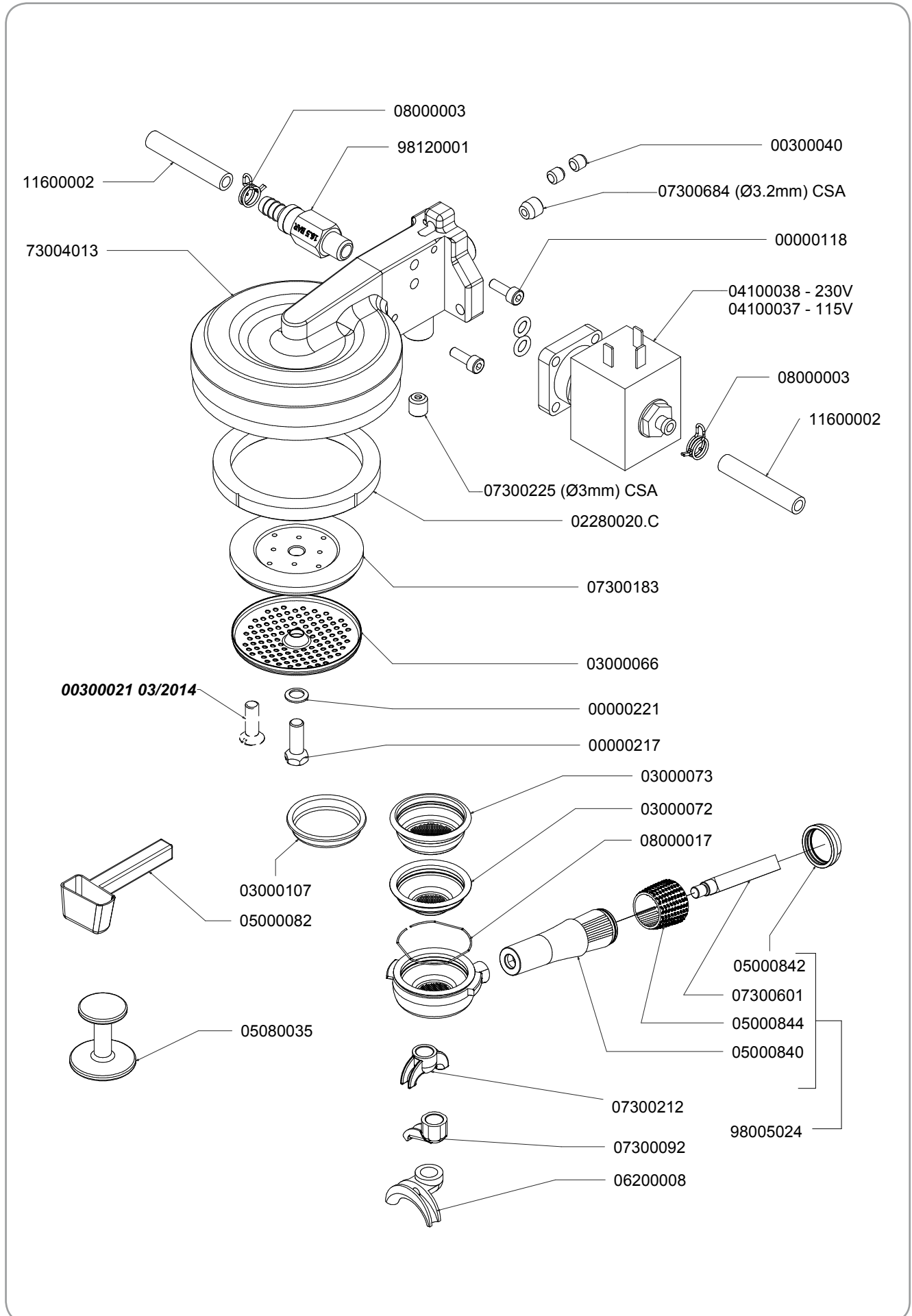

11.3 TANK FRAME COMPONENTS

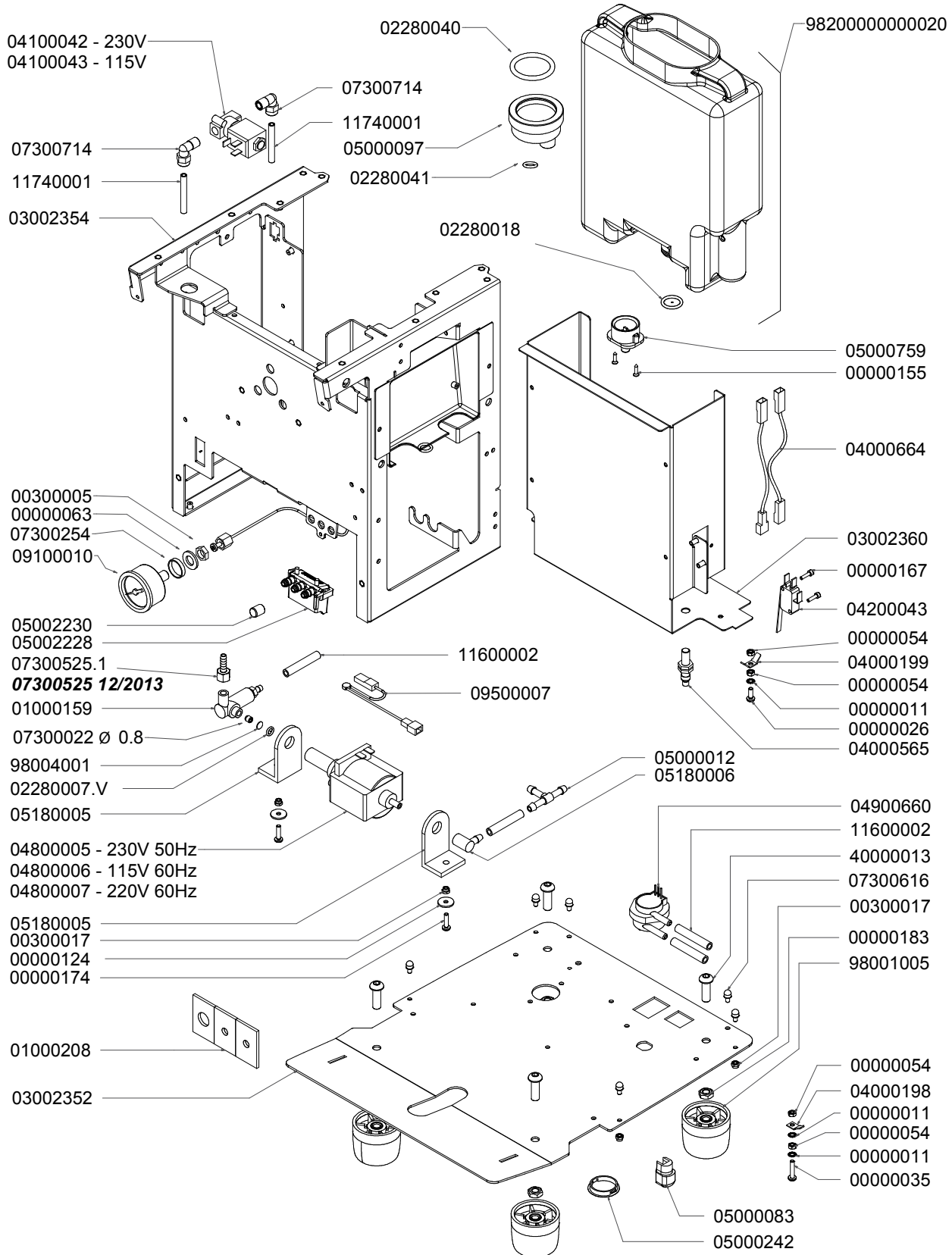

11.4 DIRECT CONNECTION FRAME COMPONENTS

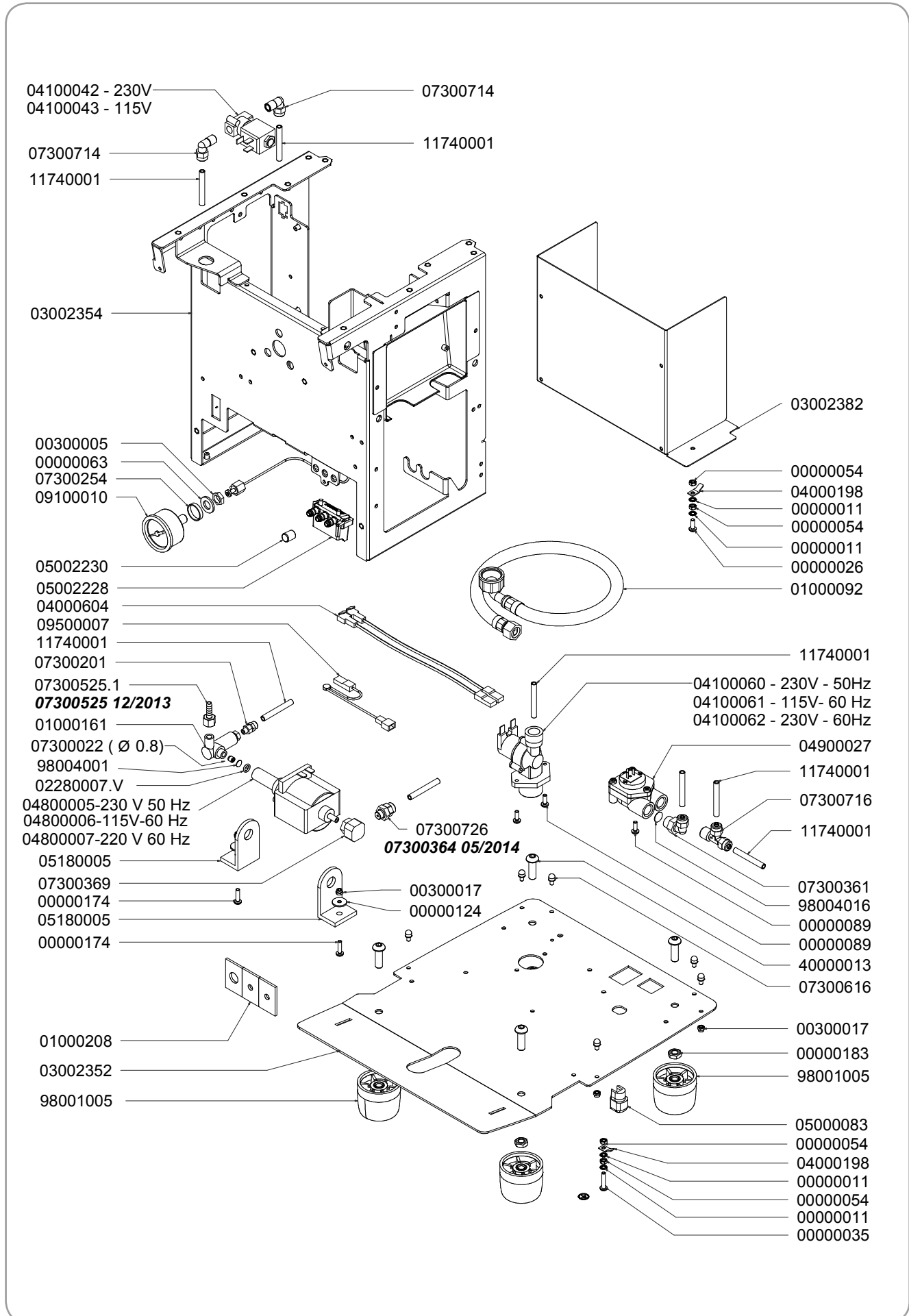

11.5 STEAM & HOT WATER VALVES PARTS

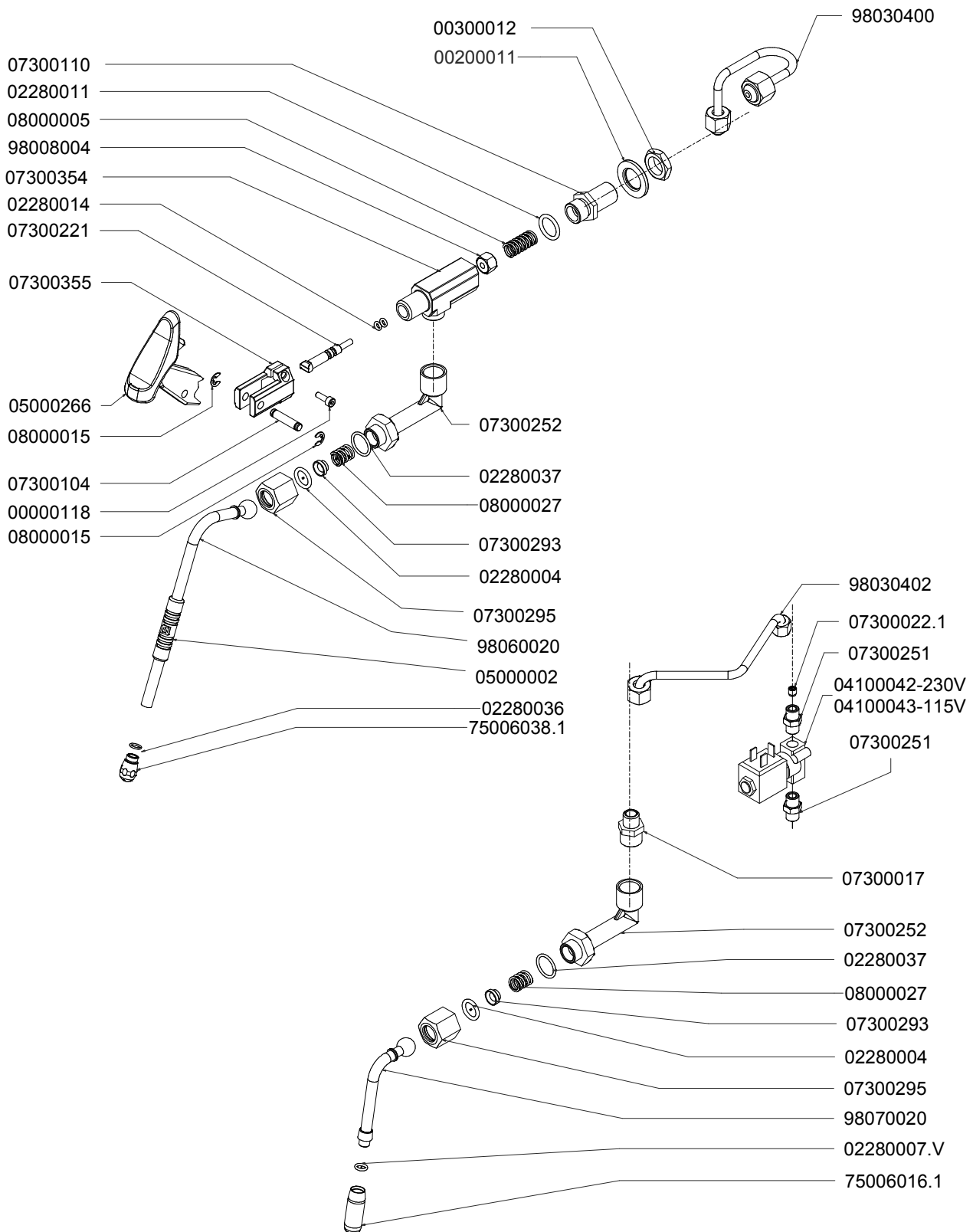

11.6 BOILER COMPONENTS

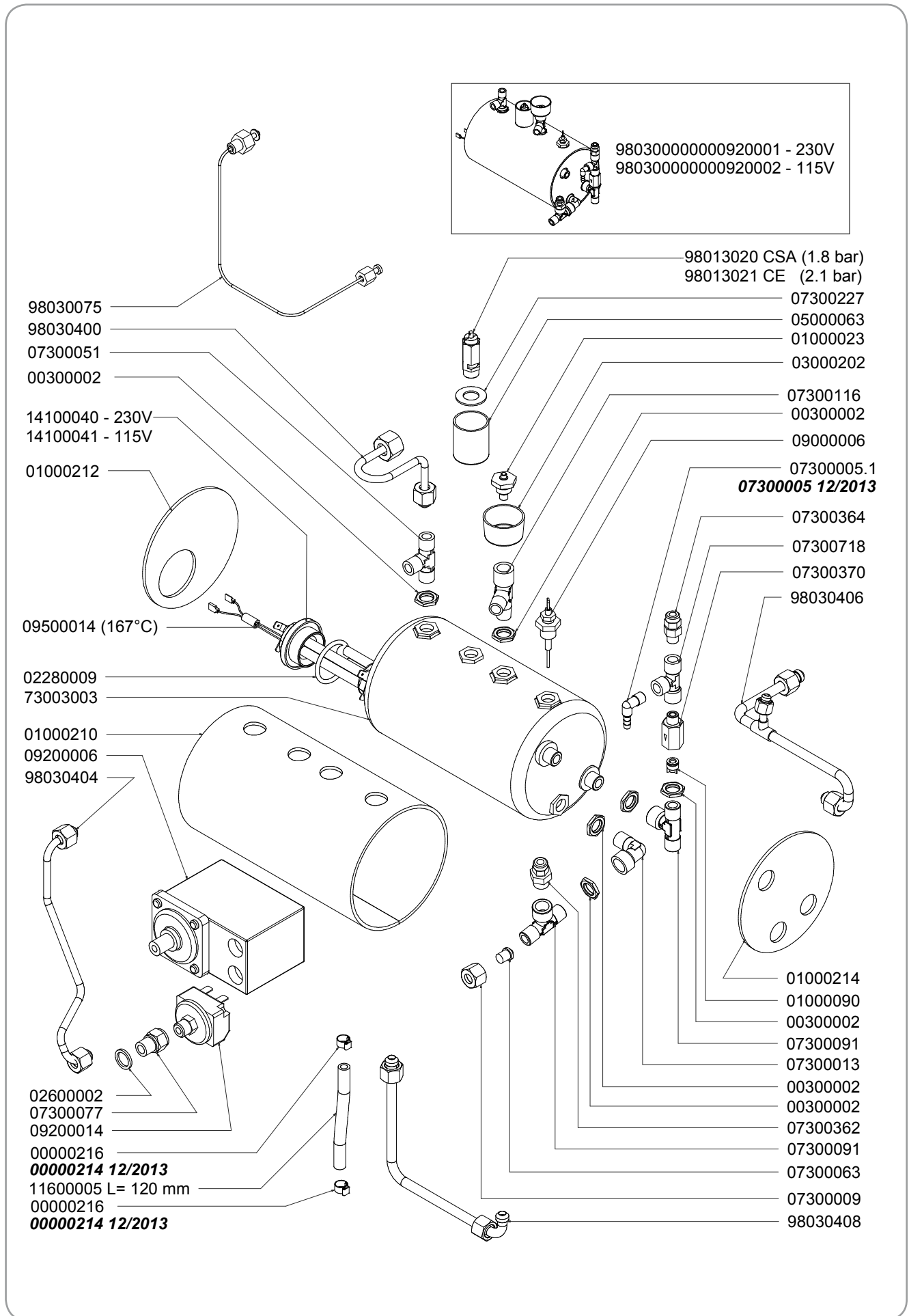

11.7 ELECTRICAL COMPONENTS

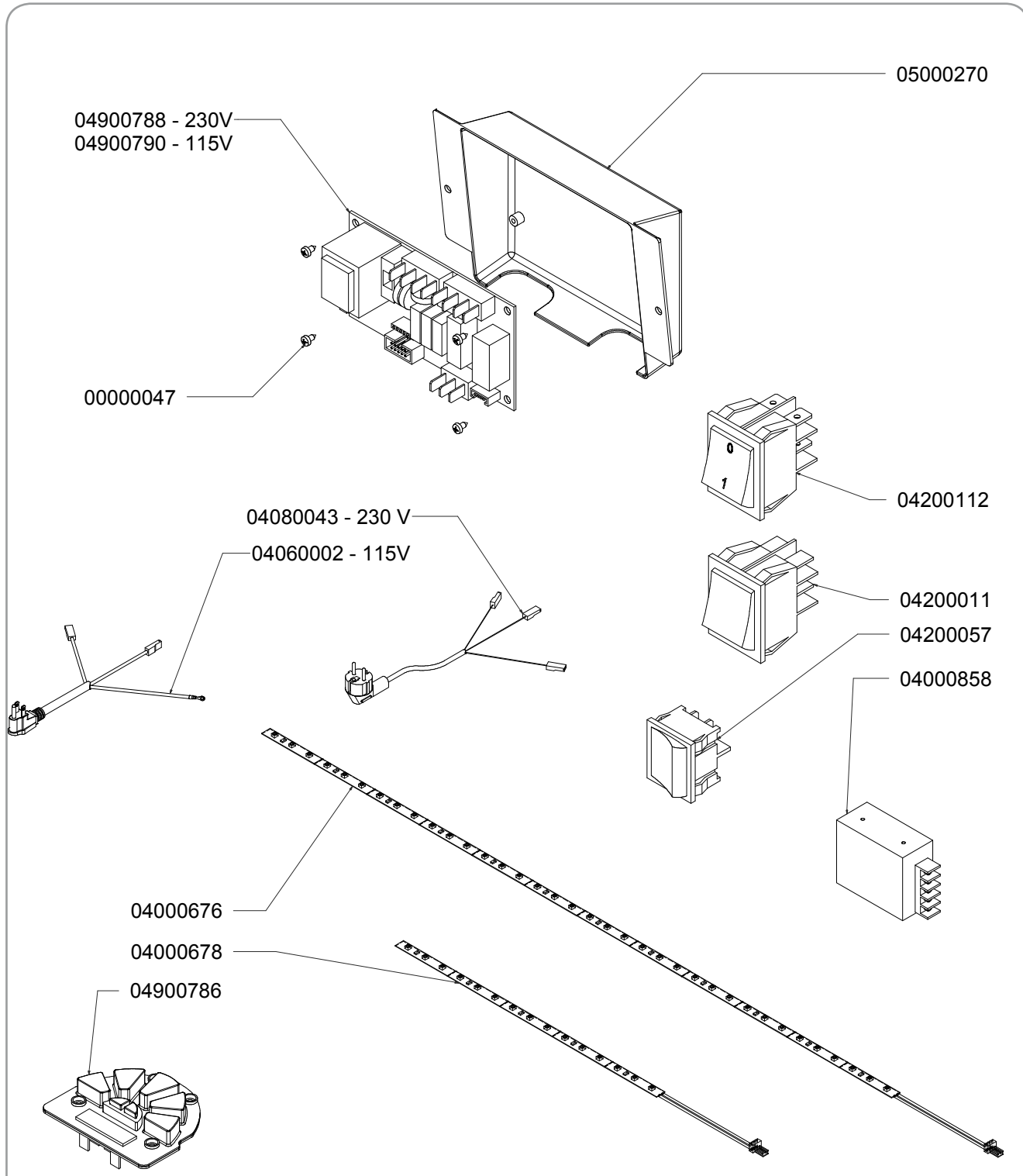

CODICE / CODE	DESCRIZIONE	DESCRIPTION
04000660	CAVO 10 VIE COLLEGAMENTO PULSANTIERA-CENTRALINA - MUSICA	CENTRAL UNIT/DISPENSING CIRCUIT BOARD CONNECTING CABLE
04000662	IMPIANTO ELETTRICO MUSICA	COMPLETE WIRING ASSEMBLY - MUSICA
04000666	CABLAGGIO BASSO VOLTAGGIO ALIMENTAZIONE LUCI - MUSICA	LIGHTING WIRING ASSEMBLY - MUSICA
04000668	CAVO ALIMENTAZIONE LUCI - MUSICA	LIGHTING TRASFORMER WIRING ASSEMBLY - MUSICA
04000670	CAVO DOSATORE VOLUMETRICO-CENTRALINA - MUSICA	VOLUMETRIC COUNTER CABLE - MUSICA
04000672	CAVO DOSATORE VOLUMETRICO ATT. DIRETTO MUSICA	VOLUMETRIC COUNTER CABLE - MUSICA D.A.

CODICE	DESCRIPTION FR	DESCRIPTION EN	END VALIDITY
00000011	RONDELLE INOX M4 MOLETÉE UNI8842/A	STAINLESS STEEL KNURLED WASHER D4	
00000026	VIS AQ M4x12 TC T.CR. ZINC	SCREW M4x12 AQ TC T. CR. ZINC	
00000035	VIS AQ M4x20 TC T.CR. ZINC	ZINC CROSS-HEAD/CAP SCREW M4X20	
00000047	VIS AUTOT 2,9x6,5 TC/T.CR.	CROSS HEAD CAP SELF-TAPPING SCREW 2,9x6,5	
00000054	ÉCROU AQ M4 HAUT ZINGUÉ	NUT M4 HIGH GALVANISED NUT	
00000063	RONDELLE AQ D 10X21X2 GALV	WASHER AQ D 10X21X2 ZN	
00000089	VIS INOX M4x12 TC TCR DIN7985	SS CROSS HEAD CAP SCREW M4x12	
00000118	VIS INOX M4x12 TCEI 5931	SS HEX SOCKET CAP SCREW M4x12	
00000124	RONDELLE D4.3X16X1.5 GALV.	GALVANISED WASHER D4 3x16x1.5	
00000155	VIS INOX P. PANN. PARTIC. 3x12 TSPTCR18-8 DIN 7505 A	SS SCREW 3x12 TSPTCR DIN 7505 A	
00000167	VIS INOX M3x12 TCEI	STAINLESS STEEL SCREW M3x12 TCEI	
00000174	VIS INOX M4x16 TCTCR	STAINLESS STEEL SCREW M4x16 TCTCR	
00000183	ÉCROU INOX M8 BAS 5589 h5	STAINLESS STEEL NUT M8 LOW 5589 h5	
00000214	COLLIER DE SERRAGE INOX DÉCLIC DIAM=9.5mm	STAINLESS STEEL CLAMP DIAM=9.5mm	12/2013
00000216	COLLIER DE SERRAGE INOX DÉCLIC DIAM=8.5mm	STAINLESS STEEL CLAMP DIAM=8.5mm	
00000217	VIS INOX M6x20mm TETE HEXAGONALE	STAINLESS STEEL SCREW M6X20 HEX HEAD 9mm	
00000221	RONDELLE CONIQUE INOX M6 SCHNORR	STAINLESS STEEL M6 CONICAL SAFETY WASHER	
00200011	RONDELLE AQ M16 17X30X3 GALV.	GALVANISED WASHER M16 17x30x3	
00300002	ÉCROU LAIT. 1/4 ÉPAISS. 3 CH18 AJ. 22.07.96	BRASS NUT 1/4 SPESSOR 3	
00300005	ÉCROU LAIT 1/8 GAZ AJ.22.07.96 ÉPAISS.4 CH13	BRASS NUT 1/8 GAS SPESSOR 4	
00300012	ÉCROU LAIT. 3/8 GAZ CH22 ÉPAISS.6 AJ. 22.07.96	BRASS NUT 3/8 GAS SPESSOR 6 HEX 22	
00300017	ÉCROU AUTOBLOQ INOX M4 BAS DIN985	SELF-LOCKING STAINLESS STEEL NUT M4 HIGH DIN 982	
00300021	VIS INOX M6x18 TSP TC DIN963	SS SLOTTED COUNTERSUNK SCREW M6X18 DIN963	03/2014
00300040	VIS SANS TÊTE INOX M6X6 TIP PLAT	SS GRUB SCREW M6X6 FLAT HEAD	
01000023	SOUPAPE DE DÉCHARGE	ANTI VACUUM VALVE	
01000090	CLAPET DE RETENUE CO10	RETAINING VALVE CO10	
01000092	TUYAU AMENÉE EAU 1,5mt EPDM 3/8F LAIT. - 3/4F90°	3/8F-3/4F90° WATER CHARGE PIPE 1,5mt	
01000159	BY-PASS DRT RÉG. POUR ÉLECTROPOMPE AVEC OR / RESSOR	ADJUSTABLE BY-PASS FOR MOTOR PUMP+O RING E L17cm	
01000161	BY-PASS DRT RÉG. POUR ÉLECTROPOMPE POUR RACCORD DIRECT	ADJUSTABLE BY-PASS FOR DIRECT CONNECTION MACHINE	
01000208	KIT ANTIVIBRATION MOUSSE ADHÉSIF ÉP.3 x POMPE	MOUSSE ANTI-VIBRATING ADHESIVE	
01000210	ISOLANT CHAUDIÈRE D.110 205x353OSCAR	BOILER INSULATION D.110 205 x 353	
01000212	ISOLANT D.110 DRT CHAUDIÈRE	INSULATION D.110 RIGHT BOILER	
01000214	ISOLANT D.110 GCHE CHAUDIÈRE	INSULATION D.110 LEFT BOILER	
02280004	JOINT OR 115 D.17 EP856 ARTICULATION BUSE	GASKET OR 115 D17 EP851 x SWIVEL STEAM PIPE	
02280007.V	JOINT OR R5A D.10 DF801 VITON	ORING GASKET R5A D.10 DF801 VITON	
02280009	JOINT OR 139/4131 D.40 EP851	GASKET OR 139/4131 D.40 EP851	
02280011	JOINT OR R11 D19 EP 851	GASKET O RING R11 D19 EP 851	
02280014	JOINT OR D7 AN2/OR102 SILICON7XL1715	GASKET O RING D.7 AN2/OR102 SILICON	
02280018	JOINT OR R11 D19 SILICONE ROUGE Sh70	RED SILICON GASKET O RING Sh70	
02280020.C	JOINT SOUS COUPE 073X058X7 TYPE C 82/84 Sha	GROUP GASKET	
02280036	JOINT OR POUR BEC BUSE VAP. D.10 EPDM70	GASKET OR x STEAM WAND NOZZLE	
02280037	JOINT OR FERMETURE ARTICULATION 16x2	GASKET OR JOINT LOCK 16x2	
02280040	JOINT OR4112 28,17x3,53 XP70	GASKET OR4112 - 28.17 x 3.53 XP70	
02280041	JOINT OR2031 7,65x1,78 XP70	GASKET OR2031 - 7.65 x 1.78 XP70	
02600002	JOINT CIRCULAIRE TEFLON	CIRCULAR TEFLON GASKET	
03000066	DOUCHETTE INOX 056X05,5X6	SHOWER INOX 056X05,5X6	
03000072	FILTRE 1 CAFÉ HAUT 7 g	FILTER ONE COFFEE HIGH	
03000073	FILTRE 2 CAFÉ HAUT 14 g	FILTER TWO COFFEE HIGH	
03000107	FILTRE AVEUGLE	BLIND FILTER	
03000202	BAC DE RECUEIL CONDENSATS MASTER AJ. 07/06/1997	CONDENSATION TRAY MASTER	
03002352	BASE CHÂSSIS MUSICA	BASE FRAME - MUSICA	
03002354	CHÂSSIS MACHINE MUSICA	MACHINE FRAME - MUSICA	
03002360	TÔLE SUPPORT RÉCIPENT EAU MUSICA	WATER CONTAINER SUPPORT PANEL - MUSICA	
03002362	TÔLE PORTE-TASSES MUSICA	CUP HOLDER PANEL - MUSICA	
03002364	CARROSS. FAÇADE EMBOUTIE MUSICA	DEEP DRAWN FRONT CASE - MUSICA	
03002366	TÔLE DE PROTECTION GROUPE MUSICA CSA	SS PROTECTION GROUP PANEL - MUSICA	
03002382	TÔLE FERMETURE CHÂSSIS RACC. DIRECT MUSICA	LOCKING PLATE FRAME - MUSICA D.A.	
03002383	GRILLAGE EN INOX PLAN TRAV. MUSICA	STAINLESS STEEL MESH, WORK SURFACE - MUSICA	
04000198	FICHE A LAMELLE M 6.3 d4.2 45°	FOIL HOLDER M 6.3 D 4.2 45°	
04000199	FICHE A LAMELLE DOUBLE M 6.3 d4.2 45°	DOUBLE FOIL HOLDER M 6.3 D 4.2 45°	
04000565	CAPTEUR MAGNÉTIQUE M8x30 L=300	WATER TANK MAGNETIC SENSOR M8x30 L=300	
04000604	SUPPLÉMENT EV ENTRÉE MICROB.2004 ACQUASTOP	EXTRA INLET SOLENOID MICROB.	
04000660	CABLE CONNEXION CENTR.-CARTE EXTRACT. MUSICA	CENTRAL UNIT/DISPENSING BOARD CONNECTING CABLE	
04000662	CÂBLAGE COMPLET MUSICA	COMPLETE WIRING ASSEMBLY - MUSICA	
04000664	CÂBLAGE MICRO RÉSERVOIR MUSICA	WIRING MICRO-SWITCH WATER CONTAINER MUSICA	
04000666	CÂBLAG. ALIMENTAT. ÉCLAIRAGE MUSICA	LIGHTING WIRING ASSEMBLY - MUSICA	
04000668	CÂBLAG. ALIMENTAT. TRANSF. ÉCLAIRAGE MUSICA	LIGHTING TRANSFORMER WIRING ASSEMBLY - MUSICA	
04000670	CABLE COMPTEUR VOLUMÉTRIQUE MUSICA	VOLUMETRIC COUNTER CABLE - MUSICA	
04000672	CABLE COMPTEUR VOLUMÉTRIQUE RACC DIRECT MUSICA	VOLUMETRIC COUNTER CABLE - MUSICA D.A.	
04000676	STRIP LED RETRO MUSICA L=60 DRT- GCHE	LED STRIP SIDE LIGHTS - MUSICA L=60	
04000678	STRIP LED RETRO MUSICA L=25	LED STRIP REAR LIGHTS - MUSICA L=25	
04000858	TRANSF. LED ARRIÈRE ADONIS/MUSICAIN:100/240V OUT:12V CE	BACK LED TRANSFORMER ADONIS	
04060002	CABLE ALIM. UL AWG3x18 SJO 10A 90°C FICHE USA 90° 2m	POWER SUPPLY CABLE UL AWG 3x18 SJT + PLUG 730	
04080043	CABLE ALIM. 2m CE FICHE SCHUKO 90° H05VV-F 3x0,75	2 m POWER CORD EC PLUG	
04100037	E.V. NC 3VOIES BASE EVAC. RACCORD 115V 60Hz VITON F1.5	3-WAYS SOLENOID VALVE 115V	
04100038	E.V. NC 3VOIES BASE EVAC. RACCORD 230V 50/60Hz VITON F1.5	3 WAYS SOLENOID VALVE 230V	
04100042	E.V. NC 2VOIES 1/8-1/8 220-230V 50/60Hz VITON F2 CE PI	ELECTR. 2-WAY 1/8" F2 230V 50/60Hz	
04100043	E.V. NC 2VOIES 1/8-1/8 110-120V 60Hz VITON F2 UL PI	ELECTR. 2-WAY 1/8" F2 115V 60Hz	
04100060	E.V. NC 2VOIES 3/4-JG 6 DROIT. RÉGL+FILTR F.2,5 230V 50/60Hz	2-WAY SOLENOID VALVE 3/4-JG 6 230V 50/60HZ	
04100061	E.V. NC 2VOIES 3/4-JG 6 DROIT. RÉGL+FILTR F.2,5 115V 60Hz UL	2-WAY SOLENOID VALVE 3/4-JG 6 115v 60HZ	
04100062	E.V. NC 2VIE 3/4-JG6 DROIT. UL RÉGL+FILTR F.2,5 208/240V60Hz	2-WAY SOLENOID VALVE 3/4-JG 6 230V 60HZ UL	
04200011	INTERRUPTEUR BIPOLAIRE LUMINEUX ROUGE RECTANGULAIRE	BIPOLAR LUMINOUS SWITCH	
04200043	MICRO PORTE/TIROIR MASTER/ MICROBAR/CAF. ITA.	DOOR DREGS DRAWER MICRO-SWITCH	
04200057	INTERRUPT. ALLUMAGE BIPOL. GRAND 10A UL 22x19 "AURELIA"	ON/OFF SWITCH 10A UL 22x19	
04200112	INTERRUPTEUR BIPOLAIRE LUMINEUX ROUGE 0-1 16A UL	ON/OFF SWITCH 16A UL	
04800005	POMPA ÉLECTROMÉC. 230V 50Hz	VIBRATION PUMP V230/50	
04800006	POMPA ÉLECTROMÉC. 120V 60Hz	VIBRATION PUMP 115V 60Hz	
04800007	POMPE ÉLECTROMÉCANIQUE 220V 60Hz 64W	ELECTROMECHANICAL PUMP 220V 60Hz 64W	
04900027	DOSEUR VOLUMÉTRIQUE LAIT.	FLOWMETER	
04900660	DOSEUR VOLUMÉTRIQUE NSF PLASTIQUE BASSE PRESSION	FLOWMETER NSF LOW PRESSURE	
04900786	CARTE EXTRACTION 5 TOUCHES MUSICA	5-KEY DISPENSING CIRCUIT BOARD - MUSICA	
04900788	CENTR. ÉLECT. MUSICA 230V REL 1.71	CENTRAL UNIT - MUSICA 230V	
04900790	CENTR. ÉLECT. MUSICA 115V REL 1.71	CENTRAL UNIT - MUSICA 115V	
05000002	CAOUTCHOUC PROTECTION BUSE D.8	RUBBER STEAM PIPE PROTECTION 8	
05000012	RACCORD PORTE-TUYAU TS 6	TS 6 HOSE FASTENING	

CODICE	DESCRIPTION FR	DESCRIPTION EN	END VALIDITY
05000063	COUVRE SOUPE DE SÛRETÉ PA6	SAFETY VALVE COVER	
05000082	DOSEUR CAFÉ MOULU 1DOSE	1 DOSE SPOON	
05000083	PRESSE-CABLE SR 11-2 NOIR	CABLE BLOCK SR 11-2	
05000097	ADAPT. FILTRE EAU POUR RÉSERVOIR	WATER FILTER ADAPTOR FOR CONTAINER	
05000242	CACHE-TROU D.31 NOIR SP-1093	COVER PLUG D.31 BLACK	
05000260.GO	CADRE COUVERCLE RÉSERVOIR MUSICA GRIS OMBRE	CONTAINER COVER FRAME - MUSICA UMBRA GREY	
05000264.C	COUVRE-GROUPE MUSICA CHROMÉ	CHROMED GROUP COVER - MUSICA	
05000266	BOUION VAP. NOIR MUSICA	STEAM KNOB - MUSICA	
05000270	SUPP. CENTRALE "MUSICA"	ELECTRONIC CONTROL BOARD SUPPORT MUSICA	
05000758.GO	COUVERCLE BAC EAU 5L MICROBAR GRIS OMBRE	5 LT WATER CHAMBER COVER - MICROBAR UMBRA GREY	
05000759	COLLECTEUR RÉCIPIENT EAU 5L MICROBAR	MICROBAR WATER CONTAINER MAINFOLD 5LT	
05000840	BOUION PORTE-FILTRE 2003 NOIR	FILTER HOLDER KNOB 2003 BLACK	
05000842	FERMETURE BOUION PORTE-FILTRE 2003	FILTER HOLDER KNOB LOCK 2003	
05000844	REVÊTEMENT CAOUTCHOUC NOIR BOUION PORTE-FILTRE	BLACK RUBBER COVER FILTER HOLDER KNOB	
05002228	COLLECTEUR VIDANGE GROUPE EXTR.	POURING UNIT DRAIN MANIFOLD	
05002230	BOUCHON CAOUTCHOUC VIDANGE x 05002228	DRAIN RUBBER PLUG	
05080035	PRESSE-CAFÉ ABS MEL	PLASTIC COFFEE PRESS	
05180005	SUPPORT POMPE EN L	L-SHAPED PUMP BRACKET	
05180006	PIPE DE RACCORDEMENT 90° POUR POMPE	SMALL PIPE	
06200008	BEC DEUX VOIES	TWO WAYS SPOUT	
06200086	CORPS PORTE-F. INCLINÉ 2003 PERSONNALISÉ N.S.	TILTED FILTER HOLDER BODY 2003	
07300005	RACCORD PORTE-CAOUTCHOUC COUDE 1/8x7mm	ANGULAR HOSE CLAMP 1/8" DIA 7	12/2013
07300005.1	RACCORD PORTE-CAOUTCHOUC COUDE 1/8x6mm	ANGULAR HOSE CLAMP 1/8" DIA 6	
07300009	ÉCROU RACCORD 1/4 GAZ	NUT CONNECTION 1/4 GAS	
07300013	RACCORD L 1/4 M-F CYLIN 458 AJ. 18/02/1997	CONNECTION L 1/4 M-F CYLIN.	
07300017	RACCORD 1/4 3/8 GAZ LAIT. AJ. 16/07/1997	FITTING 1/4 3/8 GAS OT.	
07300022	GIGLEUR EXTRACTION M 6x6 TROU 0.8mm	POURING GIGLEUR M 6x6 DIAM 0.8mm	
07300022.1	GIGLEUR EXTRACTION M 6x6 TROU 1mm	POURING GIGLEUR M 6x6 DIAM 1mm	
07300051	RACCORD T 1/4 M-M-M CYLIN 464	CONNECTION T 1/4 M-M-M CYLIN 464	
07300063	TERMINAL FERMÉ D 11	TERMINAL D 11 CLOSED	
07300077	RALLONGE 1/4 F. 1/4 M. AJ. 07/03/1985	EXTENSION 1/4 F 1/4 M ADD. 07.03.85	
07300091	RACCORD T 1/4 M-F-M CYLIN.	T FITTING MFM 1/4	
07300092	BEC UNE VOIE COURBE	SINGLE SPOUT	
07300104	TIGE DE ROBINET VAPEUR PR. *AJ. 30/05/1986	VALVE SHAFT	
07300110	BOUCHON PORTE RESSORT R.V. PR.	SPRING HOLDER TAP	
07300116	RACCORD T 1/4 M-M-F	JOINT T1/4 M-M-F 465	
07300128	BOUCHON 1/4 GAZ AJ. 31.01.89	CAP 1/4 GAS	
07300138	ADAPTEUR 1/4"M - 1/8"F EX.17 AJ. 29/05/1996	REDUCTION 1/4"-1/8" ES, 17 ADD. 29.05.96	
07300183	PAVILLON GROUPE PREMIER2002 AJ. 16.05.02	GROUP HEAD CAP	
07300201	RACCORD CYL. 6/4 M6 340/M	TEFLON TUBE M6 FITTING	
07300212	BEC DEUX VOIES PETIT	TWO WAYS SPOUT	
07300221	TIGE INOX ROBINET VAPEUR	STEAM VALVE INOX SCREW	
07300225	GIGLEUR M8x8 F.3 AG.28.05.93	GIGLEUR M8x8 F.3	
07300227	RONDELLE LAIT.D.26x13,5x1,5 AJ.5.06.03	BRASS WASHER D.26X13,5X1,5	
07300246	RACCORD 1/8F GAZ - M8.65x0.75F INOX POUR BUSE VAPEUR M	UNION 1/8 F - M8.65X0.75 SS FOR STEAM WAND - MUSICA	
07300251	RACCORD 1/8 M-M TROU 5,5 + FILET. M6 x L.=11	UNION 1/8 M-M HOLE 5.5 + M6 x L = 11	
07300252	RACCORD ROBINET-BUSE MUSICA	VALVE/WAND UNION - MUSICA	
07300254	ENTRETOISE MANOMÈTRE MUSICA	GAUGE SPACER - MUSICA	
07300293	MANCHON ARTICULÉ LAIT. AJ.25.06.96	BRASS BUSHING	
07300295	ÉCROU RACC. 3/8 BUSE ARTICULÉE LAITON NICKELÉ	WAND NUT 3/8	
07300350	GIGLEUR EV. ACQUASTOP F.0,8	GIGLEUR F.0.8 WAYS SOLENOID	
07300354	CORPS ROB. VAPEUR POUR BUSE ARTICUL. AJ. 07.04.98	STEAM KNOB BODY X FLEXIBLE WAND	
07300355	SUPPORT ROBINET '99 LAIT. AJ. 07/04/1998	TAP FORK	
07300361	RACCORD L TOUR 1/4 M-A CANULE 6 VITON 346 A NICKELÉ	PIVOTING CONNECTION L 6 1/4 VITON346A	
07300364	RACCORD DR. M. CON.6 1/8 A CANULE 340	STRAIGHT FITTING 1/8 SHEATH TYPE D.6	5/2014
07300369	RACCORD DIRECT POUR POMPE ÉLECTROMÉCANIQUE	DISCHARGE FITTING FOR ELECTROMECHANICAL PUMP	
07300370	CORPS CLAPET DE RETENUE/NEPLAX OSCAR AJ. 24/01/2000	BRASS BODY RETAIN V. /NEPLAX OSCAR	
07300525	RACCORD PORTE-C 1/8F D7	HOSE CLAMP 1/8 7mm	12/2013
07300525.1	RACCORD PORTE-C 1/8F D6	HOSE CLAMP 1/8 6mm	
07300529	MANCHON FILETÉ 1/8 450	THREADED SLEEVE 1/8	
07300601	INSERT BOUION PORTE-FILTRE 2003 INOX	FILTER HOLDER KNOB INSERTION 2003 STAINLESS	
07300616	AXE M4 MICROBAR	MICROBAR CASE PIN M4	
07300684	GIGLEUR M8x8 F.3.2	GIGLEUR M8x8 F.3.2	
07300713	RACC. DROIT 1/8M - A CANULE 4	STRAIGHT FITTING 1/8 M - D. 4 PIPE	
07300714	RACCORD L 1/8 M - A CANULE 6	L FITTING 1/8 SHEAT TYPE D6	
07300715	RACCORD T 1/8 M - A CANULE 6 - A CANULE 6	1/8 M T CONNECTION - D. 6 PIPE	
07300716	RACCORD T 1/4 M - A CANULE 6 - A CANULE 6	1/4 M T CONNECTION - D. 6 ACTUATOR	
07300718	RACCORD T 1/8 F-F-F	TEE FITTING 1/8" F-F-F	
07300719	RACCORD T 1/8 M - A CANULE 4 - A CANULE 4	1/8 M T CONNECTION - D. 4 PIPE	
07300721	RACCORD L TOUR 1/8 M-A CANULE 4 VITON	L FITTING 1/8 M VITON - D. 4 PIPE	
07300724	RACC. DROIT M6 - A CANULE 4	STRAIGHT FITTING M6 - D. 4 PIPE	
07300726	RACC. DROIT 1/8M - A CANULE 6	STRAIGHT FITTING 1/8 M D6 PIPE	
08000003	COLLIER DE SERRAGE TUYAU D9.1	HOSE CLAMP D9.1	
08000005	RESSORT 6 ST 11,5x8,5x25 ROB.VAPEUR	STEAM VALVE SPRING	
08000015	ANNEAU SEEGER TYPE RS 5 INOX UNI 7434	SEEGER RING RS 5 STAINLESS STEEL	
08000017	RESSORT BLOCAGE FILTRE AC.INOX	FILTER HOLDER SPRING INOX	
08000027	RESSORT POUR BUSE SOUPLE	WAND SPRING	
09000006	SONDE DE NIVEAU AUTOM. COMP. L=70 AVEC GORGE	LEVEL PROBE REPLACE CODE 73003011	
09100010	MANOMÈTRE ÉCHELLE 0-2,5BAR 1/8 D.40 BAGUE INOX "MUSICA"	PRESSURE GAUGE 0-2.5 BAR 1/8 D.40 STAINLESS STEEL RING	
09200006	PRESSOSTAT MACHINE CE/UL	PRESSOSTAT	
09200014	PRESSOSTAT "OSCAR" 1,4BAR 1/4	PRESSURESTAT"OSCAR"	
09500007	PROTECTION THERMIQUE 2MMT 100°C	2MMT 100C THERMAL PROTECTION	
09500014	PROTECTION THERMIQUE RÉSISTANCE G5 167°C 16A 250V UI	THERMO PROTECTOR	
11600002	TUYAU SILICONE 5x8 60Sh PEROX (1m=37g) TRANSPARENT	SILICONE TUBE 5x8	
11600005	TUYAU SILICONE ENTOILÉ 5x10mm	CANVAS REINFORCED SILICONE TUBE 5x10mm	
11740001	TUYAU TEFLON 6/4	TEFLON PIPE 4X6	
11740002	TUYAU TEFLON 4/2,5 CALIBRÉ TRANSPARENT	TEFLON PIPE 4/2.5 CALIBRATED TRANSPARENT	
14100040	RÉSISTANCE CHAUDIÈRE OSCAR 1" 1200W 230V +T.P.	HEATING ELEMENT OSCAR 1200W 230V 1"	
14100041	RÉSISTANCE CHAUDIÈRE OSCAR 1" 1200W 115V +T.P.	HEATING ELEMENT OSCAR	
31000260	ÉTIQUETTE ADHÉSIVE N.SIMONELLI MUSICA 95X18	ADHESIVE DECAL 95 x 18 - MUSICA	
40000013	VIS INOX M8x25 TBEI	SS SOCKET CAP SCREW M8x25	
73003003	CHAUDIÈRE SOUDÉE /OSCAR/ AJ. 23/08/1999	BOILER - OSCAR	
73004013	GROUPE EXTRACT. CHROMÉ/OSCAR/	CHROME POURING GROUP/ OSCAR	
75006016.1	BEC EAU POUR BUSE LAIT CHROMÉ MUSICA	WATER NOZZLE FOR WAND - MUSICA	
75006038.1	BEC VAPEUR M8,65x0,75 F. 1,2 EXAG.12	STEAM TIP	

CODICE	DESCRIPTION FR	DESCRIPTION EN	END VALIDITY
98001005	PIED MACHINE BICOMPOSANT D.48 H=40 INSER.M8 FEMELLE	MACHINE FOOT D.48 H = 40 INSERT M8 FEMALE	
98004001	FILTRE INOX DIAM. 8	FILTER INOX DIAM. 8	
98004016	FILTRE INOX DIAM. 12	FILTER INOX DIAM. 12	
98005024	CORPS PORTE-FILTRE INCLINÉ + BOUTON N.S.	TILTED FILTERHOLDER +HANDLE REPLACE 98005006	
98008004	PISTON FERMETURE AVEC	COMPLETE STEAM VALVE PISTON	
98010000000056	ENSEMBLE CARROSS. CÔTÉ DRT AVEC ÉCLAIRAGE MUSICA	RIGHT SIDE CASE ASSEMBLY WITH LIGHTS - MUSICA	
98010000000058	ENSEMBLE CARROSS. CÔTÉ GCHE AVEC ÉCLAIRAGE MUSICA	LEFT SIDE CASE ASSEMBLY WITH LIGHTS - MUSICA	
98010000000060	ENSEMBLE CARROSS. ARRIÈRE AVEC ÉCLAIRAGE MUSICA	REAR CASE ASSEMBLY WITH LIGHTS - MUSICA	
980100000000640001	ENSEMBLE BAC DE RECUEIL EAU MUSICA INOX-GRIS	ASSEMBLY WATER DRAIN BOX - MUSICA UMBRA GREY	
980100000000640002	ENSEMBLE BAC DE RECUEIL EAU MUSICA INOX-NOIR	ASSEMBLY WATER DRAIN BOX - MUSICA BLACK	
980100000000660003	ENSEMBLE CARROSS. CÔTÉ DRT MUSICA INOX-NOIR	RIGHT EXTERNAL SIDE PANEL - MUSICA BLACK	
980100000000660004	ENSEMBLE CARROSS. CÔTÉ DRT MUSICA INOX-NOIR CSA	RIGHT EXTERNAL SIDE PANEL - MUSICA BLACK CSA	
980100000000660005	ENSEMBLE CARROSS. CÔTÉ DRT MUSICA INOX-FUCHSIA	RIGHT EXTERNAL SIDE PANEL - MUSICA FUXIA	
980100000000660006	ENSEMBLE CARROSS. CÔTÉ DRT MUSICA INOX-FUCHSIA CSA	RIGHT EXTERNAL SIDE PANEL - MUSICA FUXIA CSA	
980100000000680003	ENSEMBLE CARROSS. CÔTÉ GCHE MUSICA INOX-NOIR	LEFT EXTERNAL SIDE PANEL - MUSICA BLACK	
980100000000680004	ENSEMBLE CARROSS. CÔTÉ GCHE MUSICA INOX-NOIR CSA	LEFT EXTERNAL SIDE PANEL - MUSICA BLACK CSA	
980100000000680005	ENSEMBLE CARROSS. CÔTÉ GCHE MUSICA INOX-FUCHSIA	LEFT EXTERNAL SIDE PANEL - MUSICA FUXIA	
980100000000680006	ENSEMBLE CARROSS. CÔTÉ GCHE MUSICA INOX-FUCHSIA CSA	LEFT EXTERNAL SIDE PANEL - MUSICA FUXIA CSA	
980100000000700001	ENSEMBLE CARROSS. ARRIÈRE MUSICA INOX-NOIR	REAR PANEL - MUSICA BLACK	
980100000000700002	ENSEMBLE CARROSS. ARRIÈRE MUSICA INOX-FUCHSIA	REAR PANEL - MUSICA FUCHSIA	
98013020	SOUPAPE DE SÛRETÉ A5 1/4 RÉGLÉE 1,8 BAR	SAFETY VALVE 1/4 1.8 BAR	
98013021	SOUPAPE DE SÛRETÉ A5 1/4 RÉGLÉE 2,1 BAR	SAFETY VALVE 1/4 2.1 BAR	
980300000000920001	ENSEMBLE CHAUDIÈRE MUSICA "SYSTÈME SILENCIEUX" 230V	BOILER ASSEMBLY - MUSICA "SILENT SYSTEM" 230V	
980300000000920002	ENSEMBLE CHAUDIÈRE MUSICA "SYSTÈME SILENCIEUX" 110V	BOILER ASSEMBLY - MUSICA "SILENT SYSTEM" 110V	
98030075	TUYAU CAPILLAIRE 1/8-1/4 0,9x2x400 MANOMÈTRE- POMPE	CAPILLARY TUBE 1/8-1/4 0,9X2X400 MANOM.-PUMP	
98030400	TUYAU ROBINET VAPEUR - CHAUDIÈRE 1/4 3/8 "MUSICA"	1/4 3/8 BOILER/STEAM VALVE TUBE - MUSICA	
98030402	TUYAU ROBINET EAU CHAUDE - EV 1/8 3/8 "MUSICA"	1/8 3/8 SOLENOID VALVE/HOT WATER VALVE TUBE - MUSICA	
98030404	TUYAU PRESSOSTAT - CHAUDIÈRE 1/4 1/4 "MUSICA"	1/4 1/4 BOILER/PRESSURE GAUGE TUBE - MUSICA	
98030406	TUYAU SUPÉRIEUR CIRCULATION 1/4 1/4 1/4 "MUSICA"	1/4 1/4 1/4 UPPER CIRCULATION TUBE - MUSICA	
98030408	TUYAU INFÉRIEUR GROUPE EXTRACT. - CHAUDIÈRE 1/4 1/4 "M"	DISPENSING GROUP LOWER TUBE 1/4 1/4 BOILER - MUSICA	
98060020	BUSE VAPEUR D8 L=172 MUSICA LAIT. CHROMÉ	STEAM WAND D8 L = 172 MUSICA CHROMED	
98070020	BUSE EAU C D8 L=81 MUSICA LAIT. CHROMÉ	WATER WAND C D8 L = 81 MUSICA CHROMED	
98120001	SOUPAPE NEPLAX VITON 16BAR 1/8 - RACCORD MALE	NEPLAX VITON 16BAR VALVE 1/8 HOSE CLAMP	
982000000000020	ENS. RÉSERVOIR EAU AVEC FLOTTEUR MUSICA	WATER CONTAINER WITH FLOAT SENSOR - MUSICA	
982500000000004	BAC DE RECUEIL EAU DE VIDANGE DIRECTE NOIR	WATER COLLECTION TRAY DIRECT DRAIN BLACK	
982500000000005	BAC DE RECUEIL EAU DE VIDANGE DIRECTE GRIS OMBRE	WATER COLLECTION TRAY DIRECT DRAIN UMBRA GREY	

Code 31000720
Ed. 01 of 12/2015



Nuova Simonelli S.p.A.

Via M. d'Antegiano, 6
62020 Belforte del Chienti
Macerata Italy

Ph. +39.0733.9501

Fax +39.0733-950242

www.nuovasimonelli.it

E-mail: n.simonelli@nuovasimonelli.it

Nuova Distribution Centre

LLC 6940Salashan PKWY BLDG A 98248
Ferdale, WA

Ph. +1.360.3662226

Fax +1.3603664015

videoconf. +1.360.3188595

www.nuovasimonelli.it

info@nuovasimonelli.com

Nuova Simonelli reserves the right of make all modifications deemed to be necessary.