

RIDGE USER MANUAL

KERNOM
R I D G E

v1.0 - 06/17/22

Welcome to Augmented Analog

Thank you for choosing the RIDGE as the new foundation of your tone. We hope you will have as much fun playing the RIDGE as we had designing it.

This pedal you are holding is special. **It is the first augmented analog pedal in the world.** Inside lies a technology allowing you to control in real time the behavior of its key internal components.

What you will do with this technology, how you will make this circuit sound, is entirely up to you and a product of the hours you'll spend exploring its possibilities.

Happy inspiration!

TABLE OF CONTENTS

GENERAL & SPECIFICATIONS - CONTROLS AND CONNECTIONS

- 1** FRONT PANEL
- 2** MOOD FOCUS
- 3** REAR PANEL, FEATURES, SPECIFICATIONS, POWER ADAPTER REQUIREMENTS

KERNOM COMMUNITY

- 4** FIRST CONTACT WITH THE RIDGE: HOW TO DIAL IN A SOUND
- 5** SETTINGS EXAMPLES
- 6** SOCIAL NETWORKS

USER FUNCTIONALITIES

- 7** SAVING AND RECALLING A PRESET
- 8** MODIFYING THE FAVORITE PRESET

EXTERNAL CONTROL

- 9** EXPRESSION

RIDGE SETUP FUNCTIONS

- 10** MODIFY INPUT SENSITIVITY
- 11** TRIGGER PUNISHING VOLTAGE
- 12** FACTORY RESET

ADVANCED FUNCTIONALITIES - MIDI FUNCTIONALITIES

- 13** MIDI INTRODUCTION
- 14** MODIFY MIDI CHANNEL
- 15** SAVING A MIDI PRESET 1/2
- 16** SAVING A MIDI PRESET 2/2
- 17** MODIFY EXPRESSION HEEL AND TOE POSITION USING MIDI 1/2
- 18** MODIFY EXPRESSION HEEL AND TOE POSITION USING MIDI 2/2
- 19** MIDI CC INPUT & OUTPUT
- 20** TOGGLE BETWEEN MIDI THRU AND MIDI OUT

1 GENERAL & SPECIFICATIONS - CONTROLS AND CONNECTIONS

FRONT PANEL

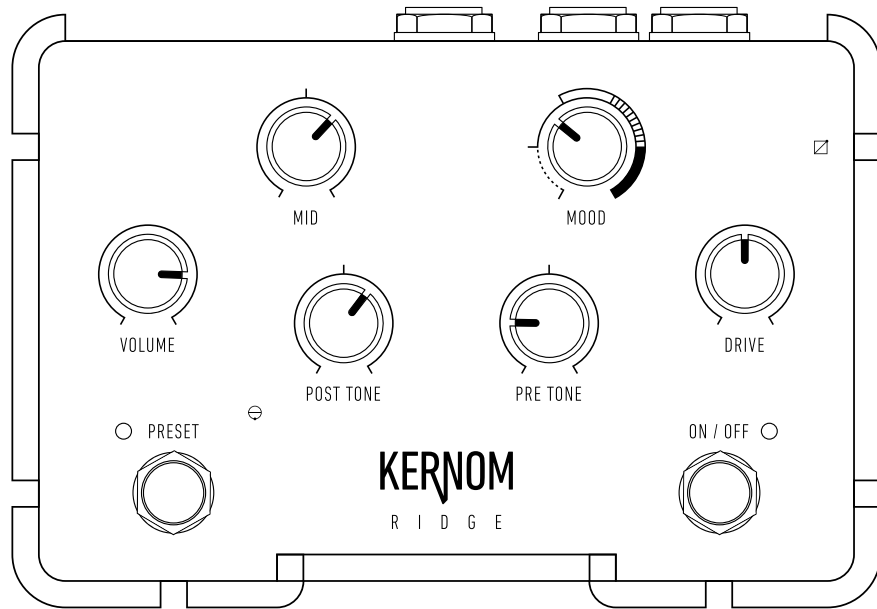

ON/OFF FOOTSWITCH

Engages and disengages the effect. Step on the ON/OFF footswitch to turn the pedal on and off. True bypass via relay when off.

PRESET FOOTSWITCH

RIDGE allows you to save and recall your favorite preset without the use of external hardware. Press and hold the footswitch to save your favorite settings. Pressing on the footswitch toggles between your favorite preset and the setting defined by the knobs' current position.

LEDs

Indicate functioning state of the pedal, depending on current use.

VOLUME

Defines the overall output level of the pedal. At maximum, when the pedal is set to high voltage mode, output voltage can go up to 30V swing (+/-15V) to push your amp to its very limits. See page 11 for instructions to enter this mode.

POST TONE

Acts after the clipping stage to precisely tailor the output sound, from fat and heavy to beautiful chime. 12'o clock is the most neutral position, depending on the chosen MOOD setting. Turn left for more low end, right for more presence.

PRE TONE

Acts before the clipping stage to change the way the pedal reacts to the guitar signal. 12'o clock is the most neutral position, depending on the chosen MOOD setting. Turn left for more body, right for more sparkle.

DRIVE

Controls the amount of drive in the signal. Varies depending on the selected MOOD setting. From clean to highly driven.

MID

Shapes the midrange frequencies, allowing you to control how the guitar signal sits in or cuts through the mix. Just like with the PRE and POST TONE knobs, 12'o clock is the most neutral position, depending on the chosen MOOD setting. Adjust the MID response by turning left for a more scooped sound, right for a more cutting one.

MOOD

Defines the clipping behavior of the pedal. From ultra high headroom soft clipping to very compressed hard clipping, and everything in between. Some settings are symmetrical, some asymmetrical. It controls the Analog Morphing Core engine inside the pedal, and is not a second drive knob: it gives its voice to the pedal and all the settings produce interesting results.

MOOD FOCUS

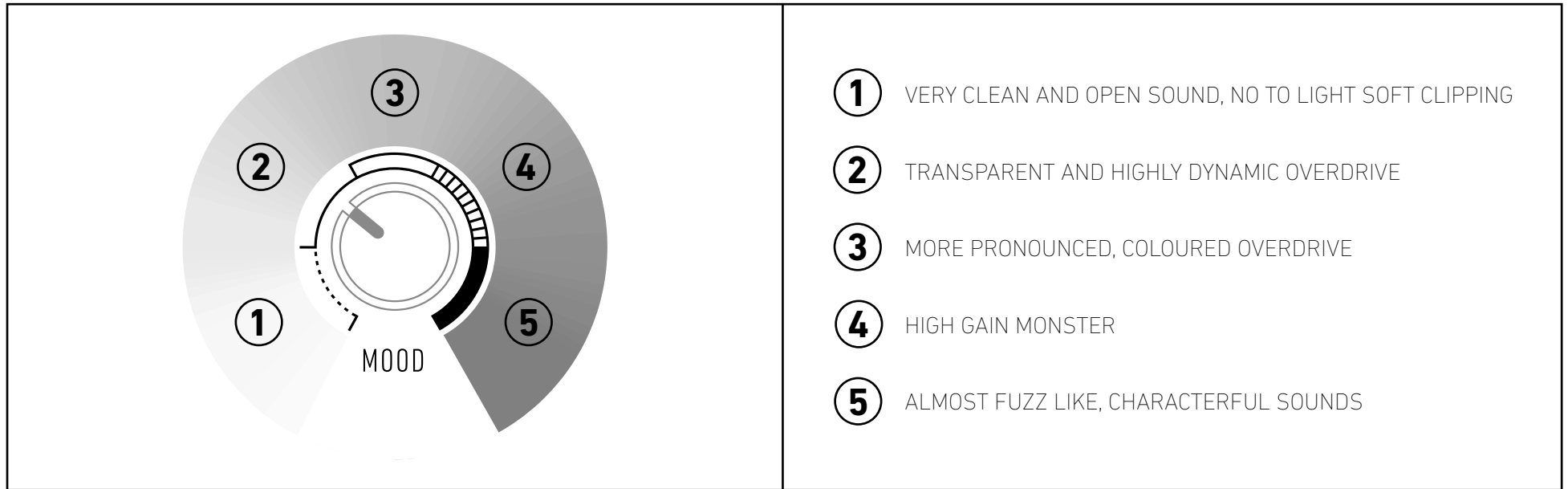

The MOOD knob is the key to control the unique patented Analog Morphing Core technology engine within the RIDGE and to define the behavior of the pedal.

Turning the MOOD knob should be thought of as choosing a different voice for the pedal. It is in effect the same as changing overdrives for a different gain flavour.

As this knob is entirely continuous, each point on the knob's moving range gives access to a different voice for the pedal. Either really transparent and dynamic, very gainy and compressed, or anything in between. The RIDGE is in effect hundreds of analog overdrives in one box, with a clutter free, seamless interface. This is why we refer to it as an "Augmented Analog" pedal: an incredible sounding analog pedal, with all the added versatility you will ever need.

To allow the user to quickly find the behavior they have in mind for the pedal, the user can use the indications given by the screen printing, dividing the MOOD into 5 "zones" each containing dozens of different voices but sharing common characteristics:

These are general indications to simplify the first contact with the pedal, but by combining the MOOD knob with the other five knobs, the user can come up with very different ways to use the pedal. Using the last Mood zone with low drive will also provide great results, as well as using the first one with a lot of drive.

3 GENERAL & SPECIFICATIONS – CONTROLS AND CONNECTIONS

REAR PANEL

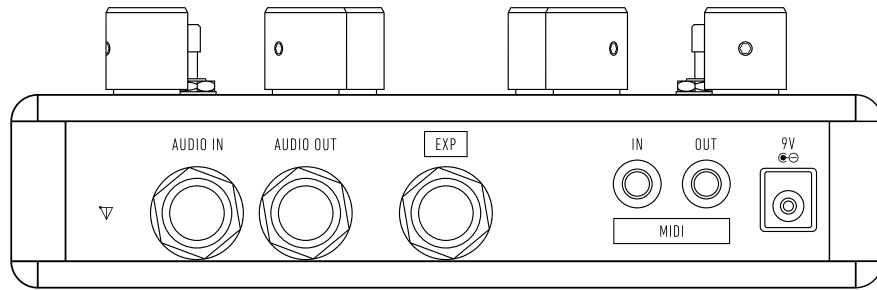

AUDIO IN

Mono audio input. Where you plug your instrument. You can toggle between instrument and line level input signal, following the procedure detailed page 10.

AUDIO OUT

Mono audio output. The cable plugged here is to be connected to your next pedal or directly to your amp. You can toggle between standard and punishing voltage output levels, following the procedure detailed page 11.

EXP

Expression input. Allows continuous control over all knobs with your expression pedal. Use a stereo cable (not included) to connect.

MIDI IN/OUT

Fully featured MIDI input and output supporting MIDI Control Changes, Program Changes, etc. See page 13 for additional details. The RIDGE uses TRS mini jack type A connections for its MIDI functionalities. It is compatible with 5 pin DIN connectors with the addition of an external adaptor (not included with the pedal).

POWER

Used to power the pedal.

FEATURES

- True Bypass
- Expression input
- MIDI In/Out
- 1 Internal favorite preset
- 127 MIDI presets
- 30V output voltage swing capability
- Premium input stage with sensitivity adjustment
- Ultra low noise output
- 5mm thick touring ready casing

SPECIFICATIONS

- INPUT IMPEDANCE:** 1Meg Ohm (Guitar mode) / 32k Ohm (Line mode)
- OUTPUT IMPEDANCE:** 100 Ohm
- BYPASS SWITCHING:** True Bypass (electromechanical relay switching)
- DIMENSIONS:** 11.2 cm deep x 16.4 cm wide x 5.2 cm tall (4.4 inches deep x 6.5 inches wide x 2 inches tall).
- WEIGHT:** 850 g (1,8 lbs)

POWER ADAPTER REQUIREMENTS

Use an adaptor (not included) with the following rating: 9VDC center negative, 250mA minimum, 300mA or more recommended.

4 FIRST CONTACT WITH THE RIDGE: HOW TO DIAL IN A SOUND

The RIDGE has six knobs, allowing the user to explore a virtually infinite number of sounds and get maximum flexibility in their tone shaping. In this respect, the pedal can almost be thought of as a musical instrument.

If you feel comfortable diving right in, be our guest, explore and have fun!

If you want a foolproof process to first learn the pedal, follow these easy steps:

To facilitate the first contact with the pedal, start with this position, which is the most transparent setting available in the RIDGE and should not sound different than your amp by itself:



From this neutral position:

1

First explore each EQ knob (Mid, Pre Tone, Post Tone) one after the other to hear their effect.

2

Then, you can start turning the Mood knob, which as is explained on page 5 is the central knob of the pedal, controlling the behavior of its circuit. Turning the Mood knob should be thought of as changing pedals and is heavily interactive with the Drive and Volume knobs.

3

Volume and Drive knobs function just like on any drive pedal. You might like different drive and volume configurations depending on your selected Mood position, just like you would like different settings on a transparent drive and a very colored drive for example.

Once you are familiar with the RIDGE:

Once you are comfortable with the different knobs and their specificities, when dialing a new sound:

1

Start by setting the Mood knob to define the "voice" of the pedal.

2

Then, with the three EQ knobs at noon (their most neutral position, no matter the Mood setting), adjust Drive and Volume to taste.

3

Finish by fine tuning your sound with the three EQ knobs.

5 SETTINGS EXAMPLES

HERE ARE A COUPLE OF SETTINGS THE KERNOM TEAM PARTICULARLY LIKES. ENJOY AND EXPLORE!

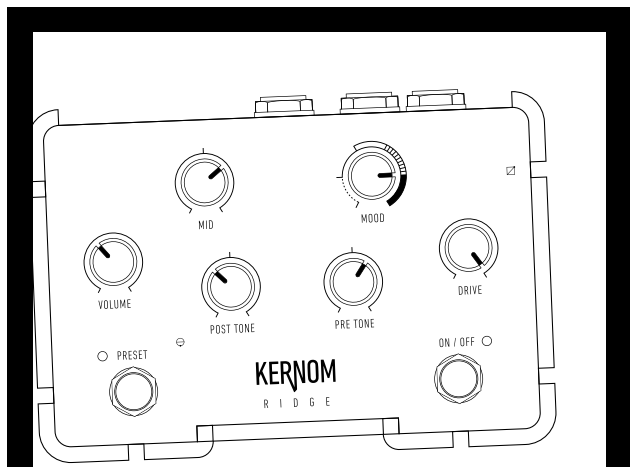

*JEREMY IS A HIGH GAIN JUNKIE,
LIVING IN HEAVY LAND.*

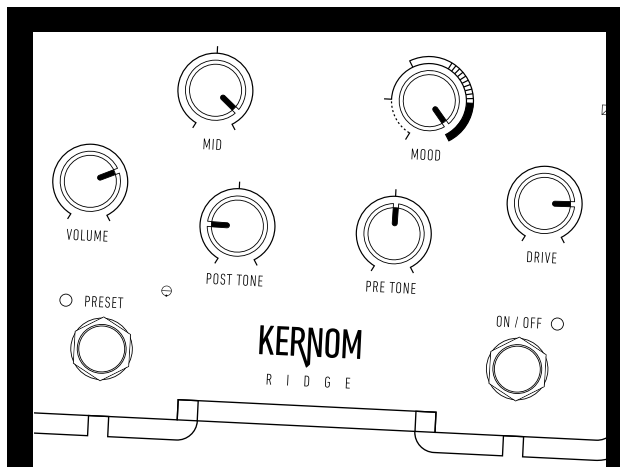

*ANTOINE ALWAYS HAD A SOFT SPOT
FOR WEIRD ALMOST FUZZY
OVERDRIVES.*

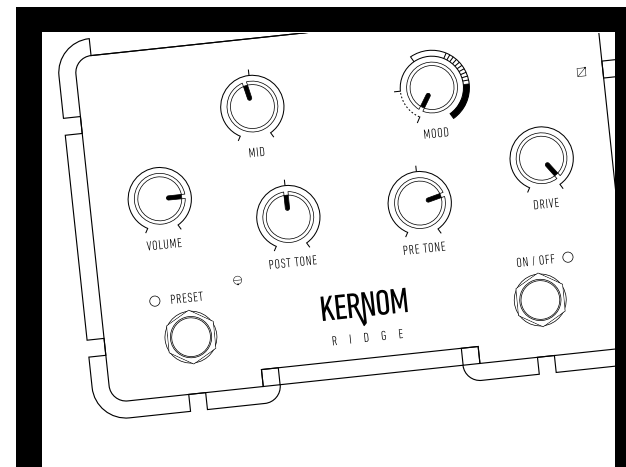

*ANTHONY LIKES THE NATURAL COLOR
OF HIS AMP AND SIMPLY WANTS TO
PUSH IT HARDER, WITH ADDED
SPARKLE.*

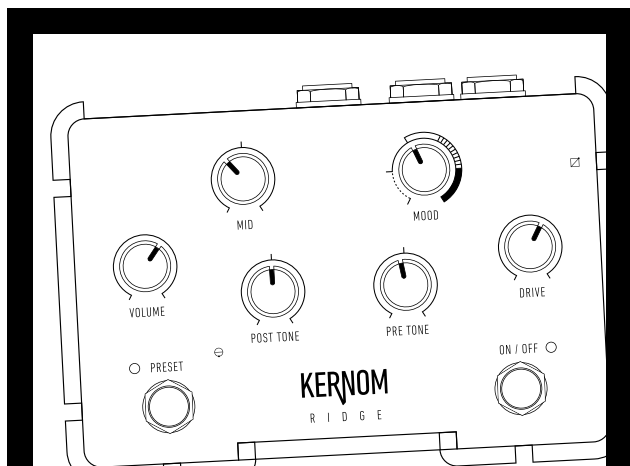

*OLIVIER LIKES COLORED OVERDRIVES,
BUT IS NOT A MID PUSH FAN.*

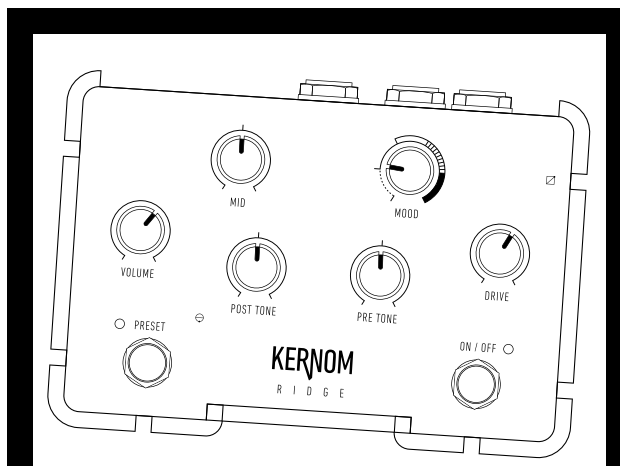

*CHARLES LOVES TRANSPARENT
OVERDRIVES.*

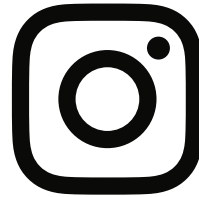
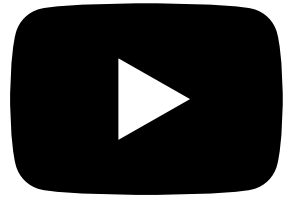

7 USER FUNCTIONALITIES - SAVING AND RECALLING A PRESET

The RIDGE gives the user the possibility to save their favorite sound to be used at any time.

This can be used in many different ways:

- As a clean boost, by saving a slightly louder version of the sound dialed in with the knobs.
- To toggle between a rhythm and a lead tone following a gain staging philosophy.
- To switch between two completely different tones, as if using two different pedals.

In order to save and recall the favorite preset, follow these simple steps:

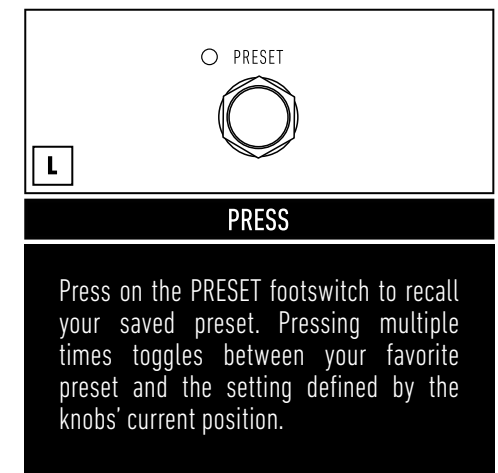
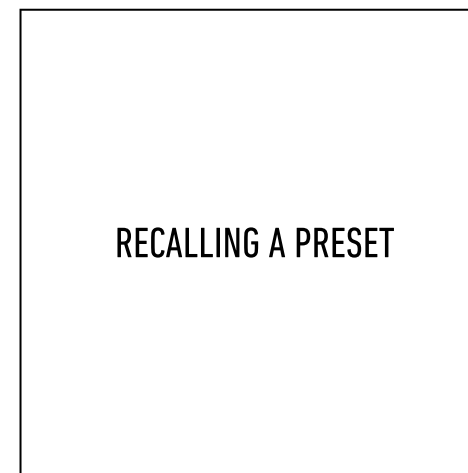
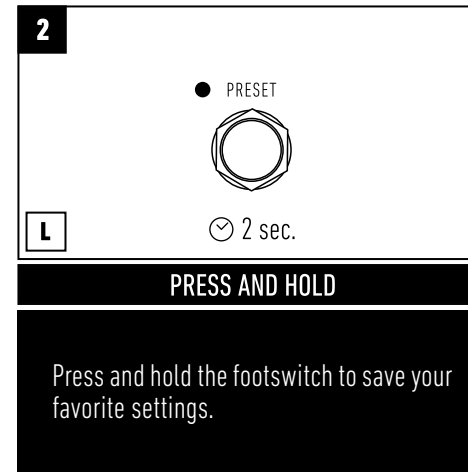
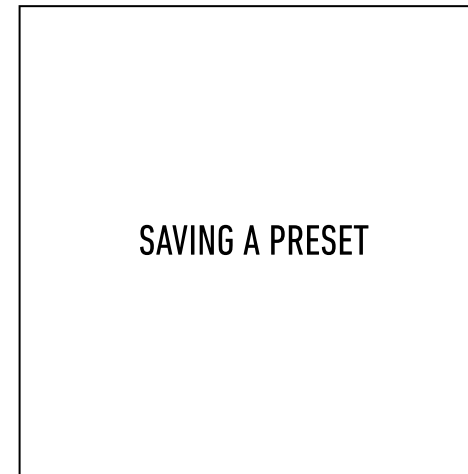

8 USER FUNCTIONALITIES - MODIFYING THE FAVORITE PRESET

After recalling the Favorite preset, the position of the knobs is decorrelated from the audio.

The user might wish to modify the preset but not remember how the knobs were positioned when the preset was created.

In order to find the saved position on one or multiple knobs, follow these simple steps

1



L

PRESS

Recall your favorite preset by stepping on the Preset footswitch.

2

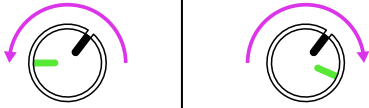

PRESET **ON / OFF**

Move the knob you wish to modify. It is inactive and has no impact on sound until you reach the saved value (■). The LEDs blink purple to indicate how to turn the knob: left if it's the Preset LED, right if it is the ON/OFF LED.

3

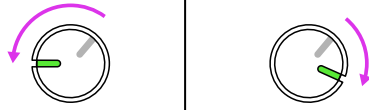

PRESET **ON / OFF**

Once the saved position (■) of the knob has been reached, the LEDs stop blinking and the Preset LED stays purple, indicating the user is in a modified version of the preset. The knob is now active again and can be dialed in to a new preferred setting.

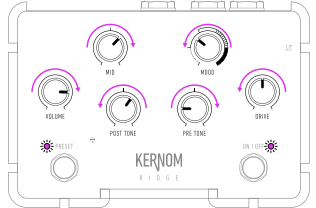

Repeat steps 2 and 3 on as many knobs as you like. If the user repeats the steps on all 6 knobs, the pedal leaves the preset as all knobs are now active.

4



L

2 sec.

PRESS AND HOLD

Once you are happy with the sound, press and hold the Preset footswitch to save the new setting.

The knobs that have been made active and modified are updated, if some knobs were not made active again following the procedure described in steps 1 to 3, their previous values remain unchanged.

9 USER FUNCTIONALITIES - EXTERNAL CONTROL - EXPRESSION

Using an expression pedal allows the user to morph (by interpolating values) between two different settings, as if the user had 6 hands turning the knobs at the same time from one position to another.

It allows to explore new sonic landscapes and leverage the possibilities offered by the RIDGE's internal Analog Morphing Core engine.

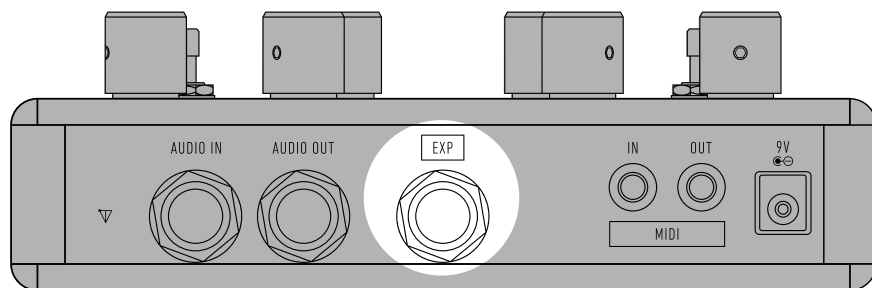

IMPORTANT!

When using the internal preset (via MIDI recall or by pressing the Preset footswitch), the expression pedal is inactive.

When using the pedal without its MIDI functionality, the expression pedal allows to morph between the setting indicated by the current position of the knobs and the internal favorite preset.

When using the pedal with its MIDI functionality, the expression pedal allows to morph between the setting indicated by the current position of the knobs and the saved MIDI preset currently in use, OR to specify different settings for the heel and toe positions (see page 17).

TO USE THE EXPRESSION PEDAL:

- 1 Plug the expression pedal using a stereo jack cable in the dedicated expression input.
- 2 Morph between the sound indicated by the knobs (heel position) and the internal favorite preset (toe position).

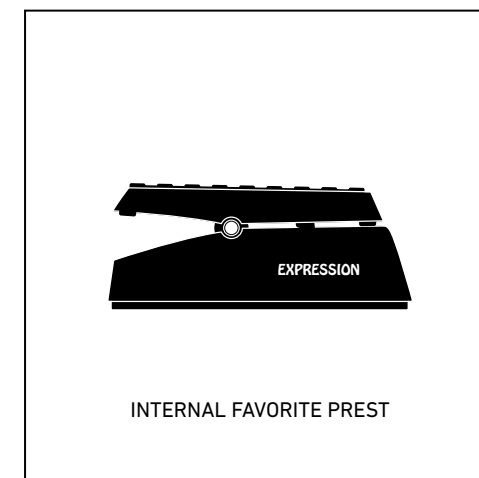
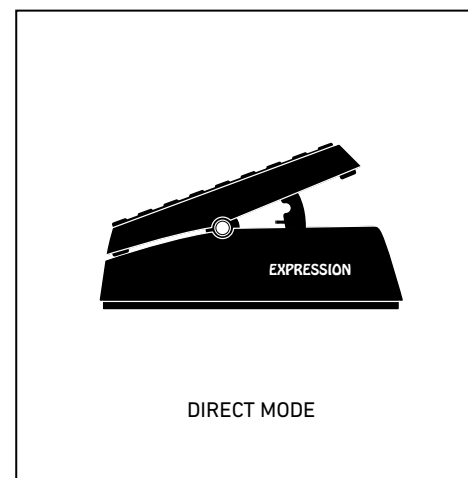

10 RIDGE SETUP FUNCTIONS - MODIFY INPUT SENSITIVITY

Out of the box, the RIDGE is set to function in
GUITAR SIGNAL LEVEL

To maximize the signal to noise ratio, the user can tune the sensitivity of the RIDGE's input stage to optimize the input level of the signal, either for a guitar (maximum input level of 2Vrms, default setting), or for line level (maximum input level of 15Vrms). If the user wants to use a keyboard or plug the RIDGE into a mixing desk: switch to high sensitivity.

In order to adjust the input level, follow steps 1 to 5:

SEE PAGE 11 ▶

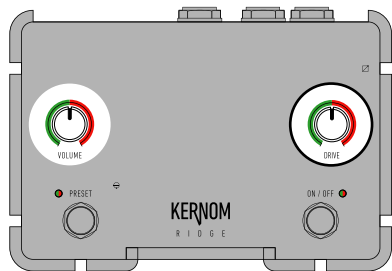

◀ YOU ARE HERE



Input sensitivity and punishing voltage (see page 11) can be defined at the same time by entering the same procedure described in steps 1 to 5 by pressing and holding the ON/OFF footswitch.

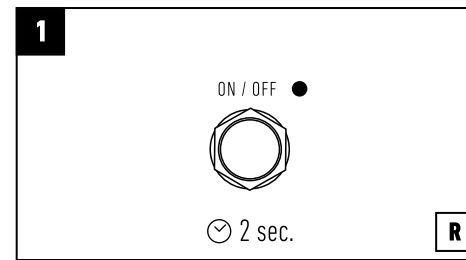

PRESS AND HOLD

- A** Press and hold the ON/OFF footswitches **before powering up the pedal.**
- B** Plug the DC cable into the pedal. 

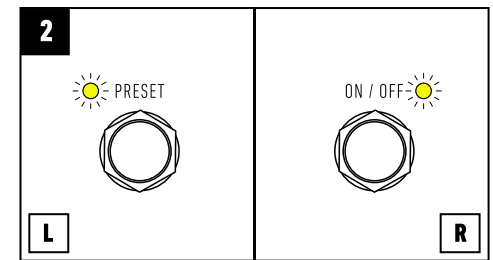

RELEASE

Both LEDs start blinking yellow.
Release PRESET footswitch.

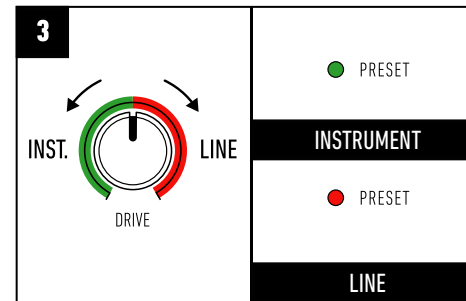

Turn the DRIVE knob to select between instrument (PRESET LED is green) and line (PRESET LED is red) levels.

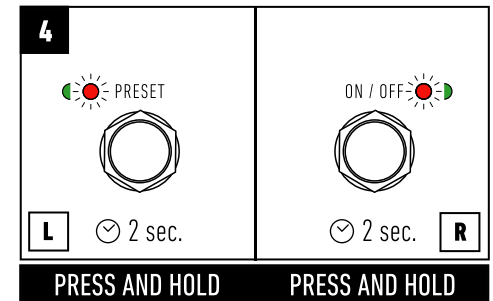

PRESS AND HOLD

PRESS AND HOLD

Press and hold both footswitches to confirm. Both LEDs start blinking in the selected color (either green or red).

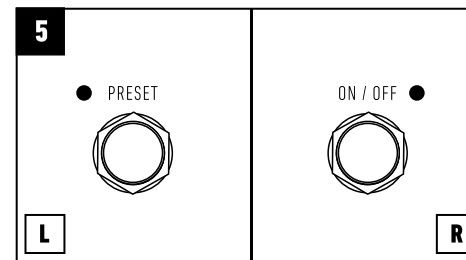

RELEASE

RELEASE

Release both footswitches.
SETTING IS OVER.
Repeat operation to change again.

11 RIDGE SETUP FUNCTIONS - TRIGGER PUNISHING VOLTAGE

Out of the box, the RIDGE is set to function in
NORMAL OUTPUT MODE

RIDGE gives the user the possibility to enter what Kernom calls the “Punishing Voltage” mode. In this mode, the pedal’s output amplitude can go up to +/-15V. This allows the user to experience extreme dynamics and to hit the front end of their tube amp very hard.

In order to toggle between normal and punishing voltage output, follow steps 1 to 5:

The 30V in question being alternate, this mode is completely safe since it does not provide any energy at all. At any point, the user could also re-enter the following procedure to revert to the normal mode.

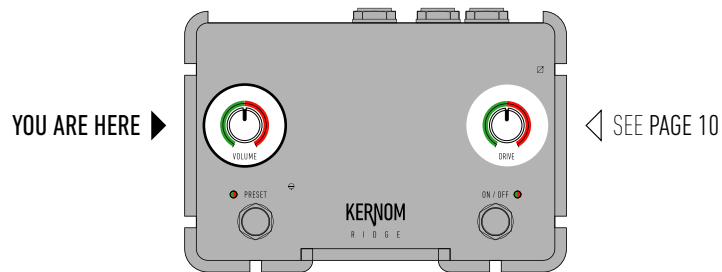

Punishing voltage and input sensibility (see page 10) can be defined at the same time by entering the same procedure described in steps 1 to 5 by pressing and holding the ON/OFF footswitch.

1

ON / OFF ●

🕒 2 sec. **R**

PRESS AND HOLD

A Press and hold the ON/OFF footswitches **before powering up the pedal.**

B Plug the DC cable into the pedal.

2

☀️ PRESET

L

ON / OFF ☀️

R

RELEASE

Both LEDs start blinking yellow. Release PRESET footswitch.

3

● PRESET

NORMAL

● PRESET

PUNISHING VOLTAGE
(+/-15V AC OUTPUT)

Turn the VOLUME knob to select between instrument (PRESET LED is green) and line (PRESET LED is red) levels.

4

☀️ PRESET

🕒 2 sec. **L**

ON / OFF ☀️

🕒 2 sec. **R**

PRESS AND HOLD **PRESS AND HOLD**

Press and hold both footswitches to confirm. Both LEDs start blinking in the selected color (either green or red).

5

● PRESET

L

ON / OFF ●

R

RELEASE **RELEASE**

Release both footswitches.
SETTING IS OVER.
Repeat operation to change again.

12 RIDGE SETUP FUNCTIONS - FACTORY RESET

Default settings the RIDGE will be reset to are **INDICATED BY SIMILAR INSERTS IN THIS MANUAL.**

At any point, the user may decide to reset the RIDGE to its factory settings. This will erase all presets, and toggle all functioning modes (MIDI out/thru, MIDI channels, Input level etc.) back to their default settings.

In order to reset to factory settings, follow steps 1 to 4:

1



Make sure the **DRIVE** and **VOLUME** knobs are **NOT** set at their minimum. Both LEDs start blinking red slowly.

2

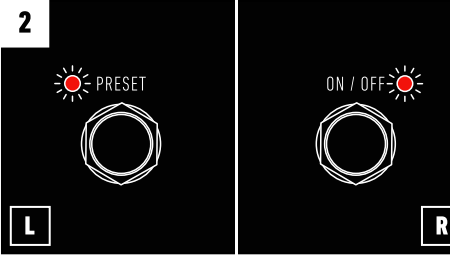

L **R**

PRESS **PRESS**

Press both footswitches to escape procedure.

1

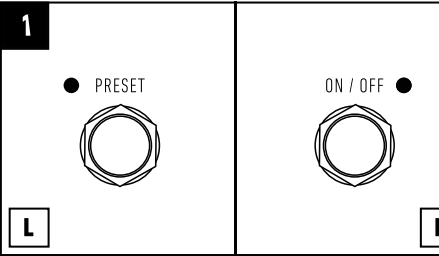

L **R**

PRESS AND HOLD **PRESS AND HOLD**

A Press and hold both footswitches **before powering up the pedal.**

B Plug the DC cable into the pedal. 

2

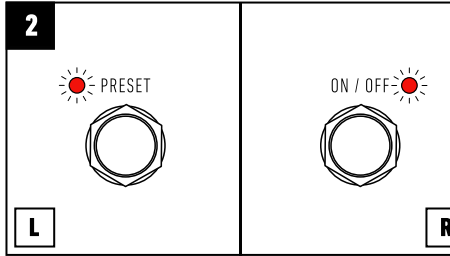

L **R**

RELEASE **RELEASE**

Both LEDs start slowly blinking red. Release both footswitches.

3

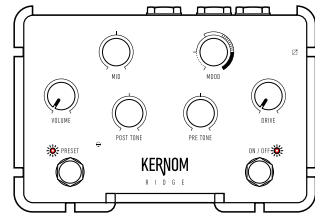

Set the **VOLUME** and **DRIVE** knobs to the minimum. Both LEDs start blinking red fast to indicate imminent factory reset.

4

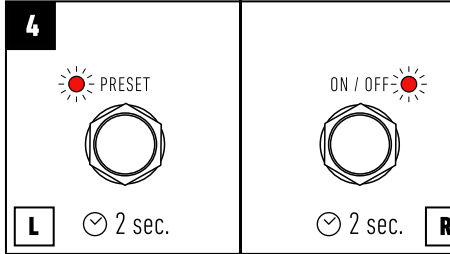

L ⌚ 2 sec. **R**

PRESS AND HOLD **PRESS AND HOLD**

Confirm the erasing procedure by pressing and holding both footswitches. The pedal just went back to the way it was out of the box.

◀ If the user has entered the reset mode by mistake and wants to exit the procedure without resetting the pedal to its factory settings, either unplug the pedal or simply follow steps 1 to 2.

MIDI INTRODUCTION

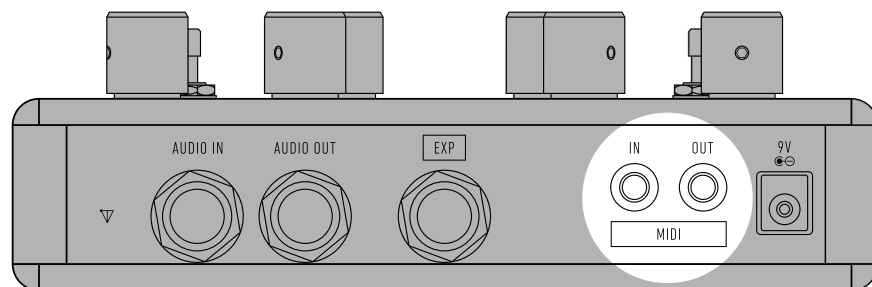

MIDI allows to further take advantage of all the possibilities given by the RIDGE's internal technology: control the pedal with a computer, a tablet, an external controller or switcher, the possibilities are endless.

MIDI gives the user access to up to 128 presets* that can be recalled with Program Changes (PC) messages at any point using an external MIDI switcher. This is more than enough to cover any kind of overdrive needs.

The use of Control Change (CC) messages, also allows the user to control all the RIDGE's internal settings with a connected MIDI controller and to come up with unique ways to interact with the pedal.

*NB: preset number 1 is the favorite preset, which can therefore be saved either by following the procedure detailed on page 9 or the one detailed on page 20.

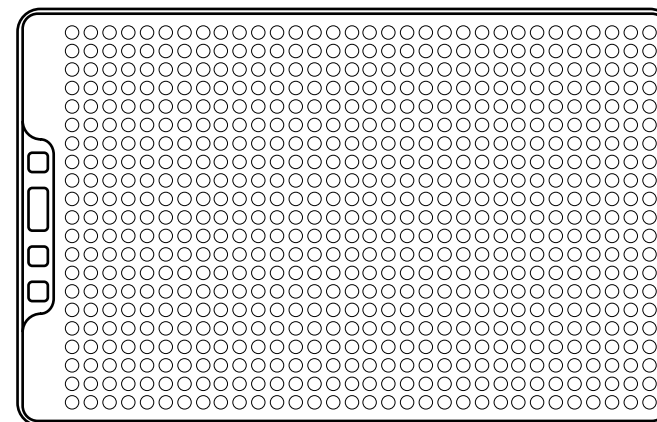
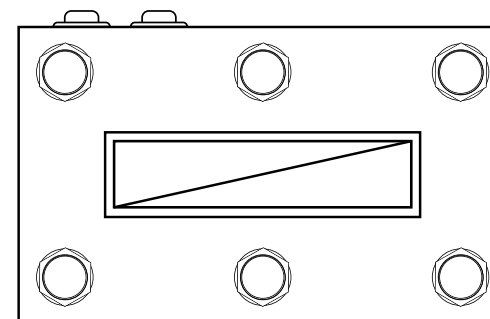
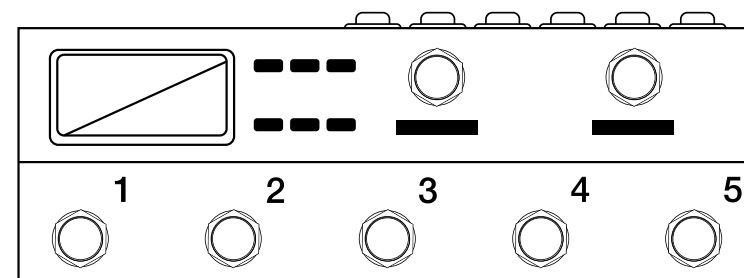

14 ADVANCED FUNCTIONALITIES - MODIFY MIDI CHANNEL

Out of the box, the RIDGE is set to function on **MIDI channel 1**

In order to make sure the RIDGE will function perfectly with other devices when using MIDI, the user can at any time modify this setting to receive MIDI messages on another channel.

In order to modify the MIDI channel of the RIDGE, follow steps 1 to 5.

SEE PAGE 20 ▶

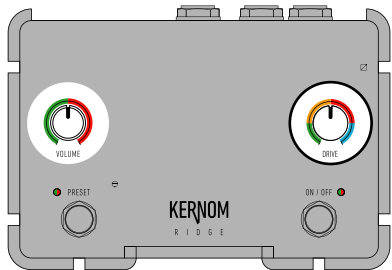

◀ YOU ARE HERE



MIDI channel and MIDI THRU/OUT (see page 20) can be defined at the same time by entering the same procedure described in steps 1 to 5 by pressing and holding the PRESET footswitch.

1

PRESET

L

PRESS AND HOLD

A Press and hold the **PRESET** footswitch **before powering up the pedal.**

B Plug the DC cable into the pedal.

2

PRESET

L

ON / OFF

R

RELEASE

Both LEDs start blinking blue. Release **PRESET** footswitch.

3

DRIVE

	PRESET	CH. 1
	PRESET	CH. 2
	PRESET	CH. 3
	PRESET	PC

Turn the **DRIVE** knob to select between the first 3 channels or to match the MIDI channel of an incoming MIDI message.

4

PRESET

L ⌚ 2 sec.

ON / OFF

R ⌚ 2 sec.

PRESS AND HOLD **PRESS AND HOLD**

Press and hold both footswitches to confirm. Both LEDs start blinking to confirm.

5

PRESET

L

RELEASE

ON / OFF

R

RELEASE

Release both footswitches. **SETTING IS OVER.** Repeat operation to change again.

15 ADVANCED FUNCTIONALITIES – SAVING A MIDI PRESET 1/2

TO SAVE THE CURRENT POSITION OF THE KNOBS IN A MIDI PRESET

1

Connect the RIDGE to an external device able to send MIDI Program Change messages via the RIDGE's MIDI Input. If needed, use an external adaptor from MIDI 5 DIN to Mini jack.

2

PRESET

L

ON / OFF

2 sec. **R**

OFF PRESS AND HOLD

Make sure you are NOT in Preset mode, with the Preset LED off. Press and hold the ON/OFF footswitch.

3

The ON/OFF LED starts slowly blinking blue, awaiting for an external MIDI Program Change message.

The ON/OFF LED starts slowly blinking blue, awaiting for an external MIDI Program Change message.

4

Send out the desired MIDI Program Change (PC 1 to 128) from your external device while making sure you are using the right MIDI channel. (see page 14)

Send out the desired MIDI Program Change (PC 1 to 128) from your external device while making sure you are using the right MIDI channel. (see page 14)

5

The ON/OFF LED starts quickly blinking blue to confirm the reception of the message and the saving procedure.

The ON/OFF LED starts quickly blinking blue to confirm the reception of the message and the saving procedure.

The pedal returns to its previous state.

TO ESCAPE THE PROCEDURE WITHOUT SAVING THE PRESET

2 sec. **R**

PRESS AND HOLD

Press and hold the ON/OFF footswitch.

The pedal returns to its previous state.

16 ADVANCED FUNCTIONALITIES – SAVING A MIDI PRESET 2/2 RECALLING A MIDI PRESET

TO SAVE THE VALUES
OF AN EXISTING MIDI PRESET
IN ANOTHER MIDI PRESET

AND TO LEARN HOW
TO RECALL A MIDI PRESET

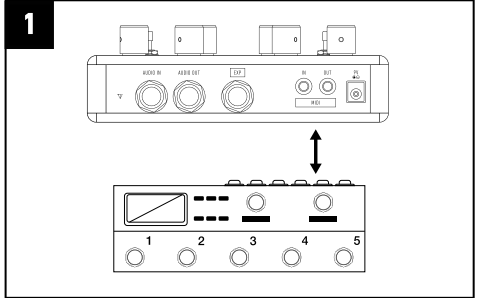

1 Connect the RIDGE to an external device able to send MIDI Program Change messages via the RIDGE's MIDI Input. If needed, use an external adaptor from MIDI 5 DIN to Mini jack.

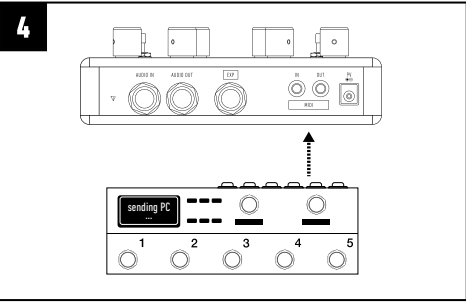

4 Send out the desired **MIDI Program Change** from your external device while making sure you are using the right MIDI channel. (see page 14)

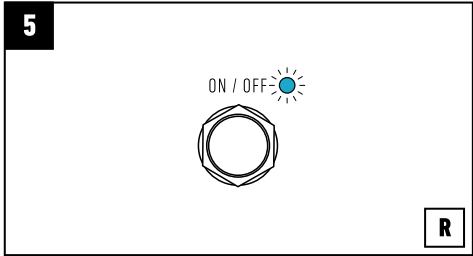

5 The ON/OFF LED starts quickly blinking blue to confirm the reception of the message and the saving procedure.

The pedal returns to its previous state.

2 Recall the MIDI preset your desire to duplicate.

To recall and hear a specific MIDI preset, the user simply sends out a Program Change message to the RIDGE from their external device, automatically turning the pedal on and recalling the desired preset (PC 1 to 128).

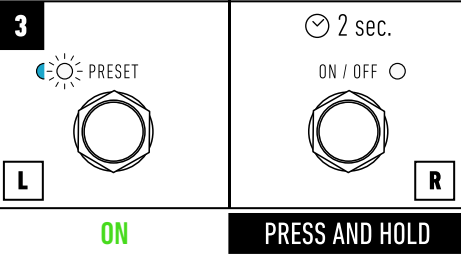

ON PRESS AND HOLD

Make sure the preset recall functioned by checking the color of the Preset LED: at this stage, it should be either white* or blue. Press and hold the ON/OFF footswitch.
*the favourite preset is in fact preset number 1

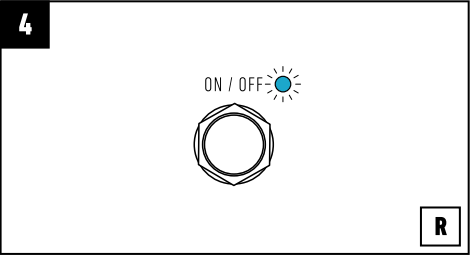

4 The ON/OFF LED starts slowly blinking blue, awaiting for an external MIDI Program Change message.

TO ESCAPE THE PROCEDURE
WITHOUT SAVING THE PRESET

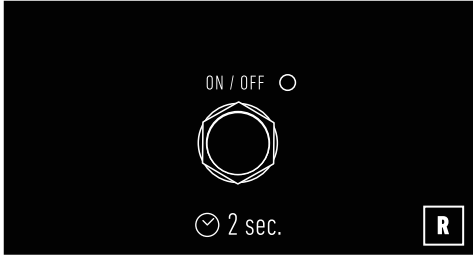

PRESS AND HOLD

Press and hold the ON/OFF footswitch.

The pedal returns to its previous state.

17 ADVANCED FUNCTIONALITIES – MODIFY EXPRESSION HEEL AND TOE POSITIONS USING MIDI 1/2

When using MIDI presets and an expression pedal, the user can morph between two sounds by assigning them to two positions: the heel position and toe position, controlled by the pedal as part of the preset. By default, before completing the procedure for the first time, the expression pedal morphs between the current value of the knobs and the saved MIDI preset.

IN ORDER TO ASSIGN HEEL AND TOE POSITION VALUES FOR THE EXPRESSION PEDAL AS PART OF A MIDI PRESET:



1

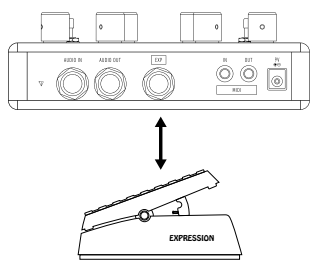

Plug the expression pedal using a stereo jack cable in the dedicated expression input.

2

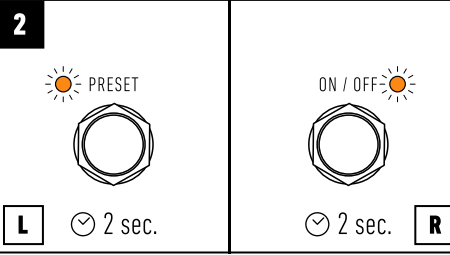

L 2 sec. **R** 2 sec.

PRESS AND HOLD PRESS AND HOLD

To enter the heel and toe setting mode, Press and hold both footswitches at the same time. Both LEDs light up in orange.

FROM THERE, TO SET THE HEEL POSITION SETTING

1

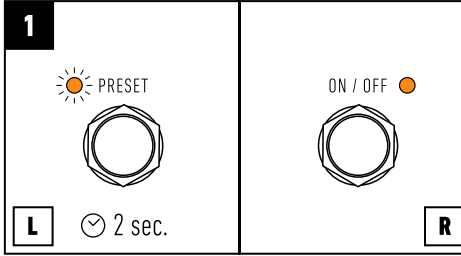

L 2 sec. **R**

PRESS AND HOLD

Press and hold the preset footswitch. The preset LED starts to slowly blink while the ON/OFF LED remains lighted up in orange.

2

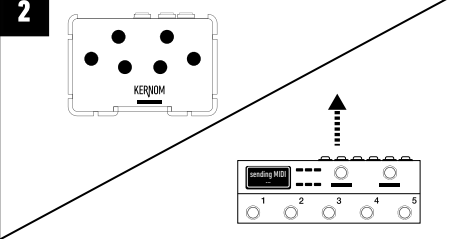

Either dial in your preferred heel position setting by turning the knobs, or send a PC message from an external controller to copy a specific preset and set it as the heel position of the preset you are creating.

3

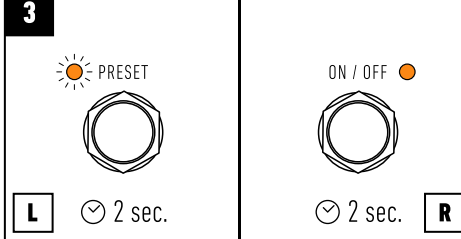

L 2 sec. **R** 2 sec.

PRESS AND HOLD PRESS AND HOLD

Press and hold both footswitches to save the heel position. The preset LED starts to blink quickly to confirm while the ON/OFF LED remains lighted up in orange.

4

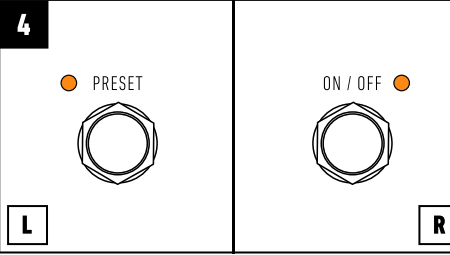

L **R**

The preset LED stops blinking and both LEDs are lighted up orange. Heel position has been set.

TO ESCAPE THE PROCEDURE OF THE HEEL POSITION

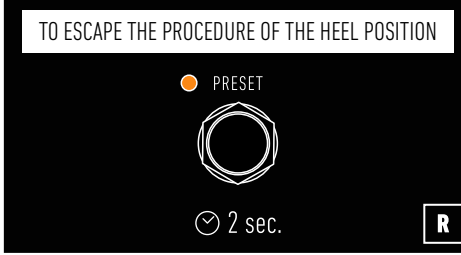

R 2 sec.

PRESS AND HOLD

Press and hold the ON/OFF footswitch.

18 ADVANCED FUNCTIONALITIES – MODIFY EXPRESSION HEEL AND TOE POSITIONS USING MIDI 2/2

4

L PRESET **R** ON / OFF

The preset LED stops blinking and both LEDs are lighted up orange. Toe position has been set.

TO ESCAPE THE PROCEDURE OF THE HEEL POSITION

R ON / OFF

2 sec.

PRESS AND HOLD

Press and hold the ON/OFF footswitch.

TO SET THE TOE POSITION SETTING

1

L PRESET **R** ON / OFF

2 sec.

PRESS AND HOLD

Press and hold the ON/OFF footswitch. The ON/OFF LED starts to slowly blink while the preset LED remains lighted up in orange.

2

Either dial in your preferred toe position setting by turning the knobs, or send a PC message from an external controller to copy a specific preset and set it as the toe position of the preset you are creating.

3

L PRESET **R** ON / OFF

2 sec. 2 sec.

PRESS AND HOLD **PRESS AND HOLD**

Press and hold both footswitches to save the toe position value. The ON/OFF LED starts to blink quickly to confirm while the PRESET LED remains lighted up in orange.

TO EXIT THE HEEL AND TOE POSITION SETTING MODE AND GO BACK TO THE PREVIOUSLY ACTIVE STATE OF THE PEDAL

L PRESET **R** ON / OFF

2 sec. 2 sec.

PRESS AND HOLD **PRESS AND HOLD**

Press and hold both footswitches. Both LEDs start blinking orange quickly to confirm. LEDs come back to the configuration they were in before the procedure was initiated.

19 MIDI CONTROL CHANGES – INPUT & OUTPUT

The RIDGE is also able to receive MIDI Control Changes (CC) to allow the user to either control it from an external device, using the following codes:

1	CC20	MID	min=0 max=127
2	CC21	MOOD	min=0 max=127
3	CC22	VOLUME	min=0 max=127
4	CC23	POST_TONE	min=0 max=127
5	CC24	PRE_TONE	min=0 max=127
6	CC25	DRIVE	min=0 max=127

1	CC26	EXP	min=0 max=127
2	CC27	FS preset	min=0 max=127
3	CC28	FS on/off	min=0 max=127

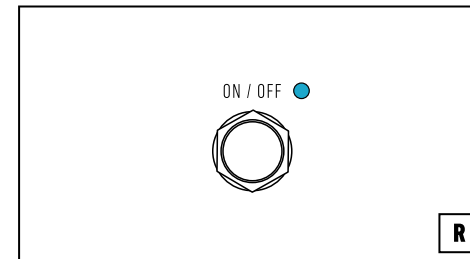

When a MIDI Control Change (CC) is sent to the RIDGE, the ON/OFF LED turns blue (CC20 to CC25) to indicate the pedal is currently using its MIDI functionalities.

The RIDGE is also able to send out MIDI Control Changes (CC) through its MIDI output, to control an external device.

When doing so, the value of the Control Change (CC) message being sent out is always that of the current position of each potentiometer.

20 MIDI CONTROL CHANGES – TOGGLE BETWEEN MIDI THRU AND MIDI OUT

Out of the box, the RIDGE is set to function on
MIDI THRU

Meaning the pedal will send out through the MIDI output the exact same MIDI messages it received through the MIDI in input.

The user can choose between this default mode, or to change the setting to MIDI OUT, where output MIDI messages correspond to the current positioning of the knobs and expression input.

In order to toggle between MIDI THRU and MIDI OUT, follow steps 1 to 5:

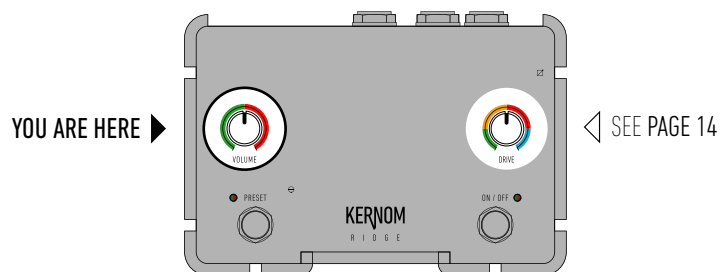

MIDI THRU/OUT and MIDI channel (see page 14) can be defined at the same time by entering the same procedure described in steps 1 to 5 by pressing and holding the PRESET footswitch.

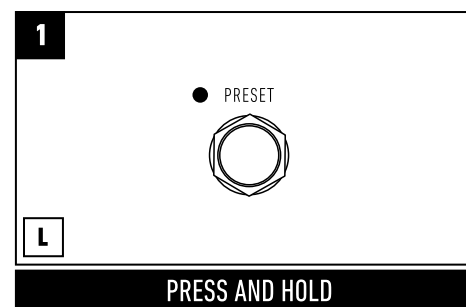

- A** Press and hold the **PRESET** footswitch before powering up the pedal.
- B** Plug the DC cable into the pedal.

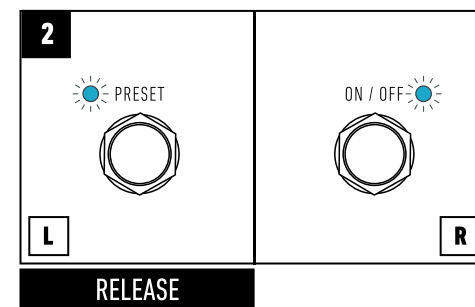

Both LEDs start blinking blue.
Release **PRESET** footswitch.

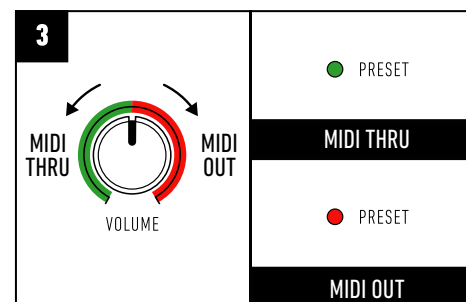

Turn the **VOLUME** knob to select between **MIDI THRU** or **MIDI OUT**.

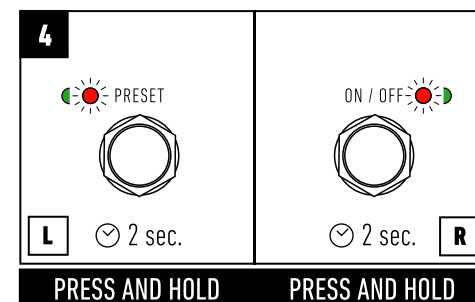

Press and hold both footswitches to confirm. Both LEDs start blinking in the selected color (either green or red).

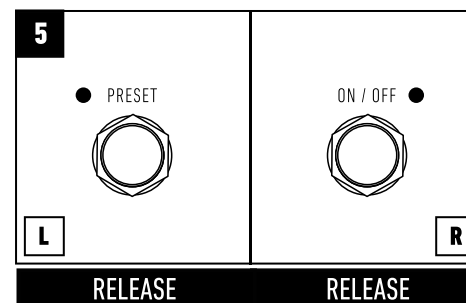

Release both footswitches.
SETTING IS OVER.
Repeat operation to change again.