

**Wilo-Stratos MAXO-Z**

		Project:					
		Engineer:					
		Contractor:					
		Submitted By:			Date:		
		Approved By:			Date:		
Tag #	Model #	Flow	Head	Control Mode	Cycle	Phase	Voltage
	Maxo-Z 1.25x3-25				60Hz	1~	115/230-240V

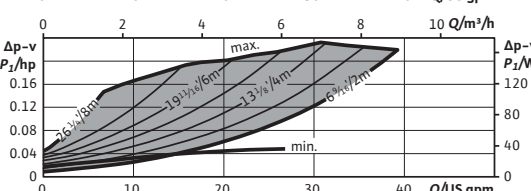
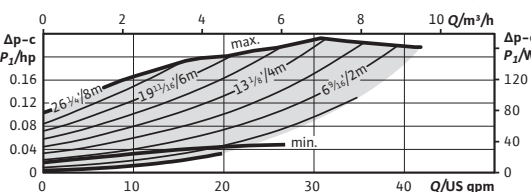
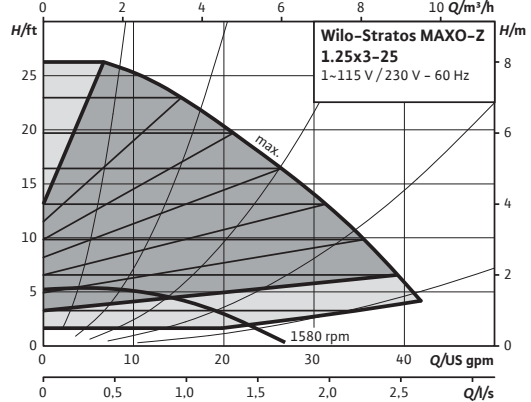
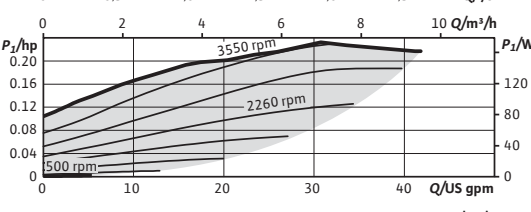
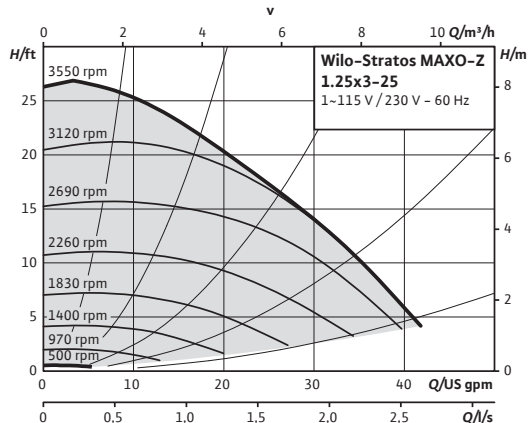

**Product Info**

Brand	Wilo
Product Description	Stratos MAXO-Z 1.25x3-25
Article Number	2164623
Net Weight (approx.)	16 lbs

**Hydraulic Data**

Max Operating Pressure PN	145 PSI
Min. Suction Head (122°F)	4.3 PSI
Min. Suction Head (176°F)	11.4 PSI
Min. Suction Head (203°F)	14.2 PSI
Min. Suction Head (230°F)	22.8 PSI
Min. Fluid Temp for SHW T	32°F
Max Fluid Temp for SHW T	176°F
Min. Fluid Temp for HVAC T	14°F
Max Fluid Temp for HVAC T	230°F
Min. Ambient Temp (SHW T)	32°F
Max. Ambient Temp (SHW T)	104°F
Min. Ambient Temp (HVAC T)	14°F
Max. Ambient Temp (HVAC T)	104°F

**CIF Module Selection**

- BACnet MS/TP
- Modbus RTU
- CANopen
- LON TP/FT-10
- PLR

**Accessory Selection**

- Immersion Temp. Sensor Pt 1000 AA
- Immersion Sleeve G 1/2", 45mm
- Pipe Surface Contact Sensor PT 1000 B
- Immersion Sleeve G 1/2", 100mm

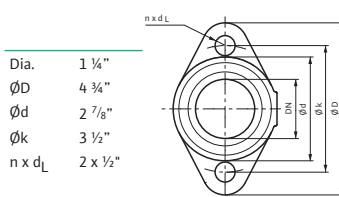

**Materials**

Pump Housing	1.4408
Impeller	PPS-GF40
Shaft	1.4122
Bearing	Carbon-graphite

**Motor Data**

Mains Connection	1~115 ±10%, 50/60Hz 1~230-240V ±10%, 50/60Hz
Motor Type	ECM
Rated Power P <sub>2</sub>	0.178 hp
Min. Speed n <sub>min</sub>	500 RPM
Max. Speed n <sub>max</sub>	3550 RPM
Power Consumption P <sub>1,max</sub>	0.233 hp
Power Consumption P <sub>1,min</sub>	0.009 hp
Max Current (1~230V) I <sub>max</sub>	0.76 A
Min Current (1~230V) I <sub>min</sub>	0.11 A
Max Current (1~115V) I <sub>max</sub>	1.53 A
Min Current (1~115V) I <sub>min</sub>	0.11 A
Insulation Class	F
Protection Class	Enclosure 2

**Electrical Inputs**

Analog Inputs (2x)	0-10V / 0-20mA / 4-20mA / PT 1000 Passive/Active +24V DC
Digital Inputs (2x)	Ext Off / Ext Min / Ext Max / Ext. MANUAL (BMS off) / External Key Lock / Switch heating, cooling
Wilo NET	Multi-Pump Communication
SSM	Fault Signal
SBM	Run Signal

**Installation Dimensions**

Pipe Connection (discharge)	1 1/4"
Pipe Connection (suction)	1 1/4"
Flange to Flange	6 1/2"

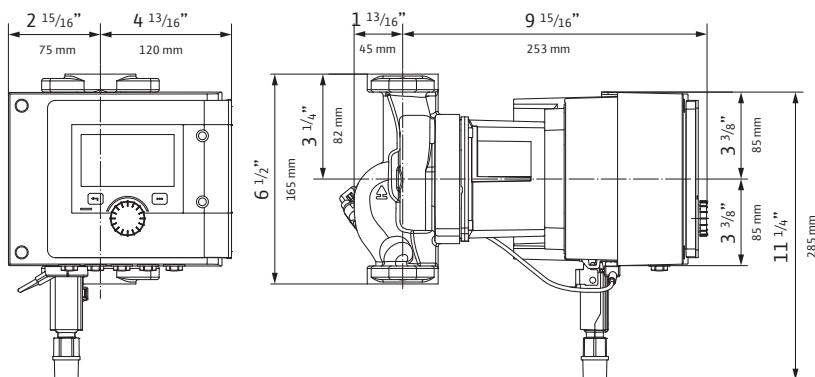

WILO USA LLC  
+1 262-204-6600  
www.wilo-usa.com  
info.us@wilo.com

WILO Canada Inc.  
+1 403-276-9456  
www.wilo-canada.com  
info@wilo-canada.com

WILO Mexico  
+52 442 167 00 32  
www.wilo-mexico.com  
info@wilo.com.mx