

# G SERIES

Centrifugal Pumps for G Series Condensate & Boiler Feed Pumps



## Technical Specifications

The Sterlco® G Series Centrifugal Pumps are designed so the motor shaft will not be exposed to water. Provisions for seal flush or vent are provided. The pumps are close-coupled to a 3450 RPM motor (open drip-proof, totally enclosed, washdown duty, or explosion-proof).

### Features

#### Standard Features

- "Sterl-Seal" ceramic pump seal (250°F.)
- Impeller is brass for long life. Efficient design provides maximum capacity, minimum motor load
- Heavy-duty cast iron pump housing and bracket assure rigidity and long life
- Flat perforated brass strainer in pump inlet prevents clogging (vertical application only)
- 1/3, 1/2 and 3/4 HP
- 3/4" NPT Discharge
- Stainless steel motor shaft
- Capacities to 30 GPM
- Discharge capacities to 46 FT.
- Motor, bracket and impeller assembly can be removed for service without disturbing discharge piping
- Available motor voltages: 115-208-230 V/1, 208-230-460 V/3, 575 V/3
- Available optional Tefcoated pump castings

#### Sample Specifications

A Sterlco® (G Series) centrifugal pump shall be furnished (and installed as shown on the plan). It will have a capacity of \_\_\_\_\_GPM @ \_\_\_\_\_feet total head pressure, without overloading the motor. The pump shall be designed so that the motor shaft will not be exposed to water. Provisions for a seal flush or vent shall be provided. The pump shall be close-coupled to 3450 RPM, (open drip-proof, totally enclosed, washdown duty or explosion-proof) motor of \_\_\_\_\_HP, \_\_\_\_\_phase, \_\_\_\_\_cycle and \_\_\_\_\_ volt. The pump shall allow the motor and impeller to be removed without disturbing the piping connections.

## Product Diagrams

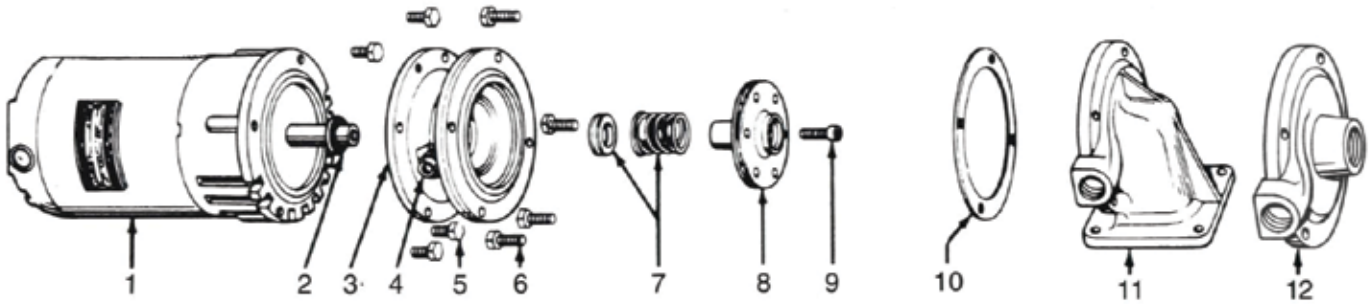

- 1. Motor
- 2. Water Slinger
- 3. Motor Bracket

- 4. Tube fitting
- 5. Motor Screws (4)
- 6. Pump screws (4)

- 7. Rotary Seal Assembly
- 8. Impeller
- 9. Impeller Screw

- 10. Housing Gasket
- 11. Pump Housing
- 12. Threaded Inlet Casting

## Removal

### Removal of old Seal Assembly

**A)** Remove pump housing from motor bracket and impeller assembly by removing pump screws.

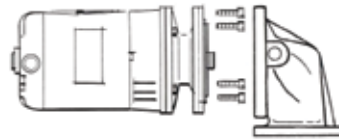

**B)** Remove impeller and screw and motor screws. (Note: opposite end of motor shaft is fitted with screwdriver slot to hold shaft securely while impeller screw is being removed).

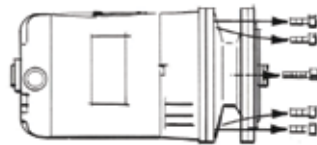

**C)** Insert two of the pump screws into the two threaded holes in the bracket. Tighten them slowly and evenly to force the impeller and bracket off the shaft. Do not pry the impeller or bracket!

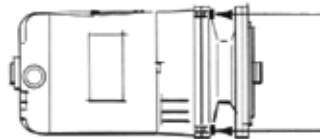

**D)** Remove old seal parts from impeller hub and bracket. Be sure water slinger is in place.

**E)** Clean impeller hub thoroughly...remove all loose particles of dirt, grease, etc. Also clean the recess in the bracket so the new seat will fit perfectly. Remove all particles and dirt on gasket surfaces of the two castings.



## Installation

### Installation of new Seal Assembly

**F)** Coat outside edge of new seat with seal lubricant and slip it into the bracket. Press into bracket with thumbs or wooden dowel. Handle seat carefully so seating surfaces are not scratched or chipped... be sure it is squarely seated.

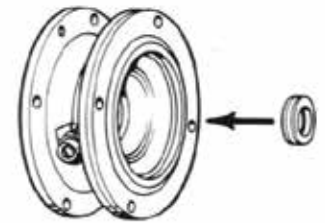

**G)** Remount bracket on motor

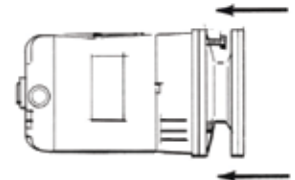

**H)** Lubricate impeller hub with seal lubricant. Slip new bellows and spring onto impeller hub. Be sure bellows slides freely on impeller hub.



**I)** Replace impeller on motor shaft and secure with impeller screw. Hold shaft with screwdriver slot while tightening screw.

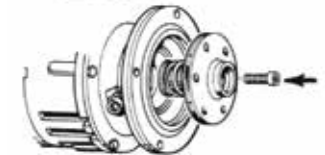

**J)** Replace pump housing onto bracket, using a new housing gasket. Secure with pump screws. Be certain gasket is seated properly.

