



PUMP SECTION

Centrifugal Pumps, Type RC07 - Close Coupled, End Suction



**General Service Pumps
Flows to 600 GPM, 110 PSI**

APPLICATIONS/FEATURES

The **MEPCO Model R Series Pumps** meet the latest standards for hydraulic performance and dimensional characteristics. The pump shall be close coupled to a NEMA standard JM motor. The pump incorporates a dry shaft design to prevent the fluid from contacting the shaft. The shaft shall be covered with a replaceable bronze (stainless steel) shaft sleeve.

The **standardization and interchangeability** for the R Series Pump line results in reduced parts inventories and lower costs for multiple pump installations. An easy-to-replace, slip-on shaft sleeve facilitates seal maintenance in the field and lowers costs. The dry shaft design protects the pump shaft by eliminating contact between the shaft and the fluid. Corrosion resistant shaft materials are not required. Standard brass sleeve or optional stainless steel sleeve will eliminate this maintenance problem.

MEPCO Model R Pumps are ideally suited for a variety of applications, including heating, air conditioning and pressure boosting.

Pump casing discharge can be located in any of six (6) positions. The pump shall be capable of being serviced without disturbing the system piping with pump back pull-out design.

The **advanced impeller design** maximizes hydraulic efficiency, dynamically balanced for vibration free operation.

The **mechanical seal is constructed of Buna N** and is rated for 250 degrees Fahrenheit and pressures up to 175 PSI. Ceramic seat and carbon seal face are stamped for long trouble free service. Alternative seals are available to suit temperatures and liquid.

Dry shaft design ensures shaft is never exposed to the system fluid.

- Simplifies sleeve and seal removal/reassembly.
- Easy-to-replace slip-on shaft sleeve facilitates seal maintenance in the field and lowers long-term maintenance costs.

MAXIMUM OPERATING CONDITIONS

BASED ON STD. CONSTRUCTION & PUMPING CLEAR WATER

RPM -	1750, 3500
HORSEPOWER -	30
STD. SEAL TEMP.-	250 DEGREES FAHRENHEIT
OPT. SEAL TEMP.	300°F = EPT, 400°F = VITON
MODEL RC07	150 LB. FLANGES
MAX. WORKING PRESS. -	175 PSI
HYDROSTATIC TEST PRESSURE -	265 PSI

MATERIALS OF CONSTRUCTION

ITEM	DESCRIPTION	MATERIAL	OPTION
1	CASE	CLASS 30 C. I.	BRONZE
2	ADAPTER	CLASS 30 C. I.	BRONZE
3	IMPELLER	BRONZE	CAST IRON
4	MECH. SEAL	BUNA N	EPT/VITON
5	SLEEVE	BRONZE	SST
6	O-RING	BUNA N	EPT/VITON
7	O-RING	BUNA N	EPT/VITON
8	WASHER	BUNA N	EPT/VITON
9	WASHER	SST	BRONZE
10	KEY	SST	
11	BOLT	STEEL	BRONZE
12	BOLT	STEEL	
13	BOLT	STEEL	
14	PIPE PLUG	CLASS 30 C. I.	BRONZE
15	MOTOR	NEMA (ODP)	TEFC/XPROOF

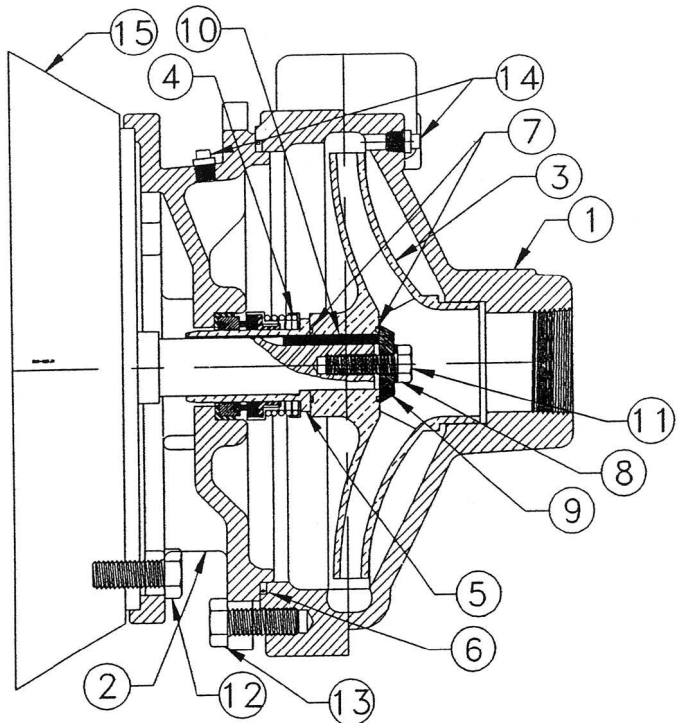

RAPID SELECTION CURVES

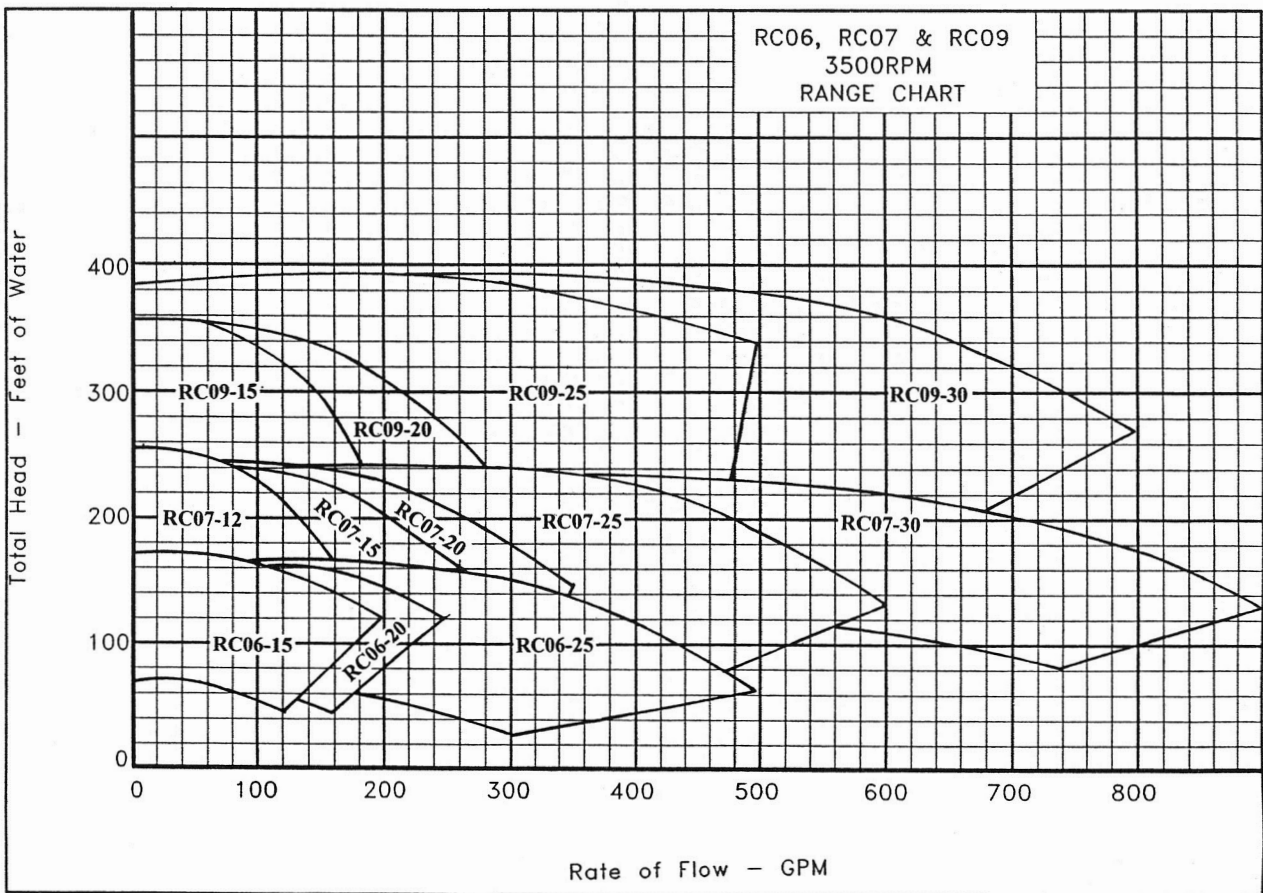
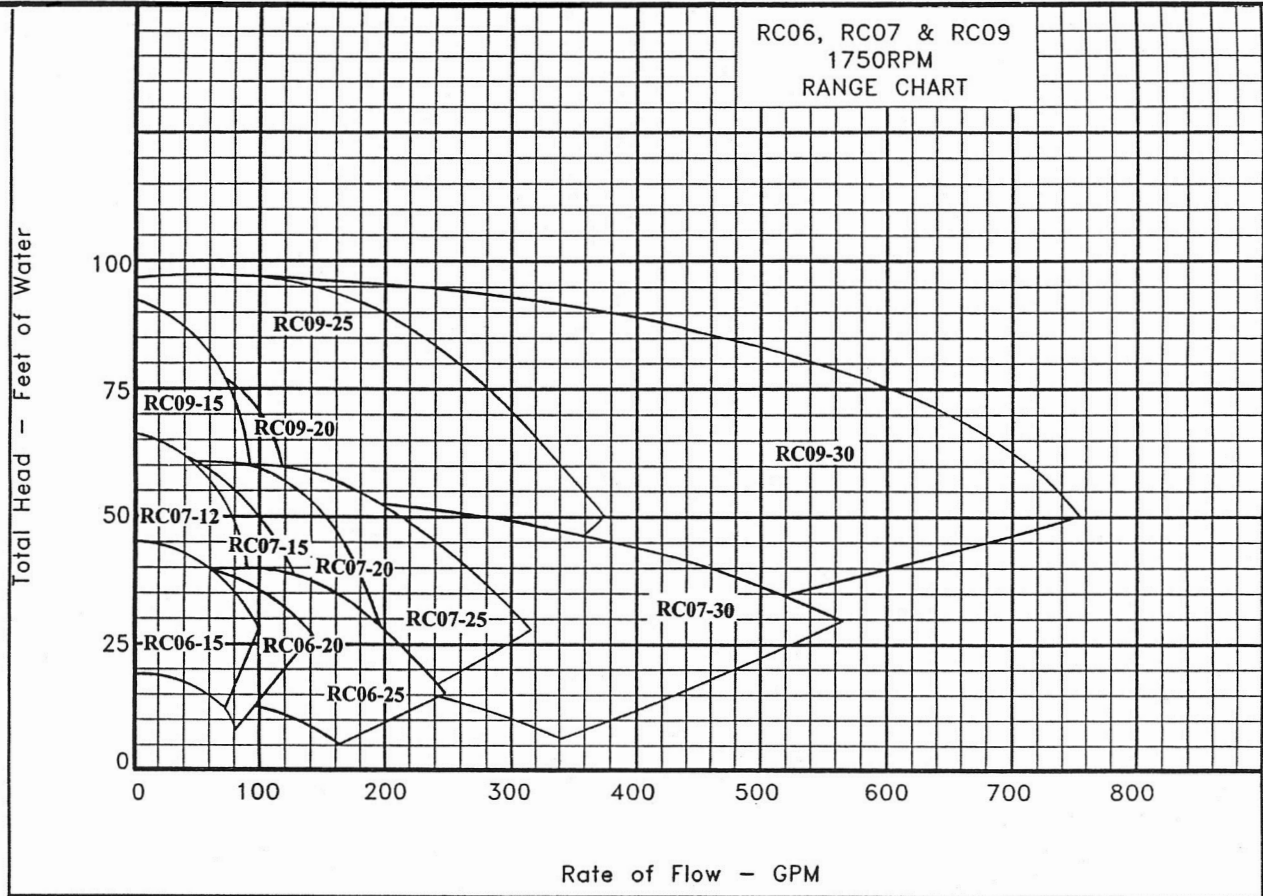

DIMENSIONS

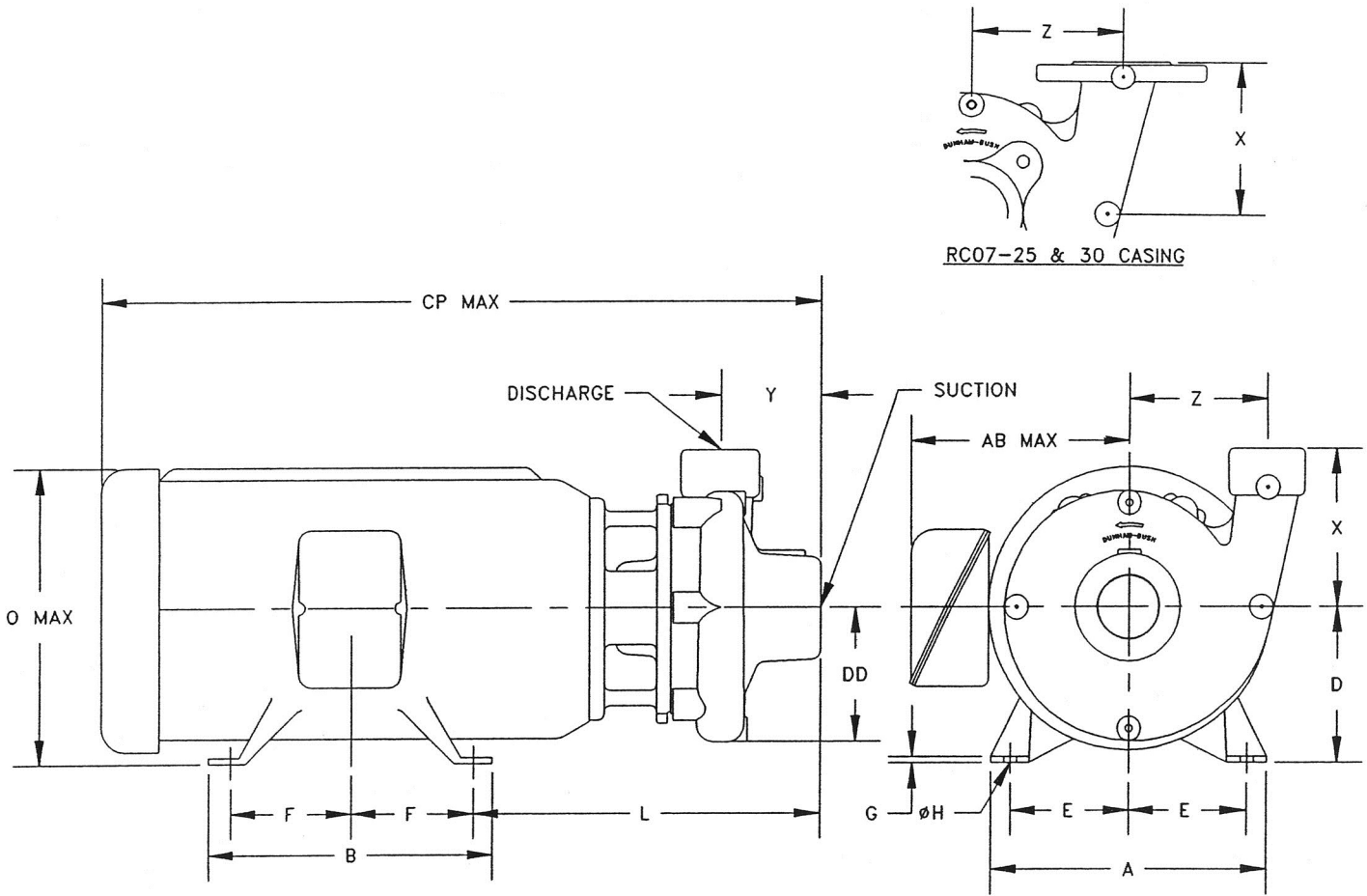

MOTOR HORSEPOWER DATA

FRAME	ODP - HORSEPOWER				TEFC - HORSEPOWER			
	1750RPM 1 ϕ	1750RPM 3 ϕ	3450RPM 1 ϕ	3450RPM 3 ϕ	1750RPM 1 ϕ	1750RPM 3 ϕ	3450RPM 1 ϕ	3450RPM 3 ϕ
143JM	1	1	1 1/2	1 1/2, 2	1	1	1 1/2	1 1/2, 2
145JM	1 1/2	1 1/2, 2	2	2, 3	1 1/2	1 1/2, 2	2	2, 3
182JM	2	3	3	5	2	3	3	
184JM		5	5	7 1/2		5	5	5
213JM		7 1/2		10		7 1/2		7 1/2
215JM		10		15		10		10
254JM		15		20				15
256JM		20		25				20
284JM		25		30				25
286JM		30		40				
324JM		40		50				
326JM				60				

DIMENSIONS

PUMP	MOTOR FRAME SIZE	DISC. NPT	SUCTION NPT	DIMENSIONS IN INCHES														
				A	AB	B	CP	D	DD	E	F	G	H	L	O	X	Y	Z
RC07 12	143JM	1 1/4	1 1/2	7	5 1/4	5 15/16	19 1/16	3 1/2	4 11/16	2 3/4	2	1/8	11/32	10 5/8	6 7/8	5 1/2	4	5 3/16
	19 13/16						2 1/2											
	9			5 7/8	6 1/2	20 3/16	4 1/2	3 3/4		2 1/4	3/16	13/32	11 1/4	8 7/16				
						21 11/16				2 3/4								
	213JM			10 1/2	7 3/8	8	22 9/16	5 1/4		4 1/4	2 3/4	1/4	13/32	12 1/2	10 1/16			
	24 9/16						3 1/2											
215JM																		
RC07 15	143JM	1 1/2	2	7	5 1/4	5 15/16	18 9/16	3 1/2	5 3/16	2 3/4	2	1/8	11/32	10 3/16	6 7/8	6 1/8	3 5/16	5 7/16
	19 5/16						2 1/2											
	9			5 7/8	6 1/2	19 9/16	4 1/2	3 3/4		2 1/4	3/16	13/32	10 13/16	8 7/16				
						21 1/16				2 3/4								
	213JM			10 1/2	7 3/8	8	22 1/8	5 1/4		4 1/4	2 3/4	1/4	13/32	12 1/16	10 1/16			
	24 1/8						3 1/2											
254JM	11 1/4	8 15/16	9 1/2	27 1/2	6 1/4	5	4 1/8	1/2	17/32	13 3/8	12							
256JM																		
RC07 20	143JM	2	2 1/2	7	5 1/4	5 15/16	19 9/16	3 1/2	5 7/16	2 3/4	2	1/8	11/32	11 3/16	6 7/8	6 1/2	4 3/16	5 11/16
	20 5/16						2 1/2											
	9			5 7/8	6 1/2	20 9/16	4 1/2	3 3/4		2 1/4	3/16	13/32	11 13/16	8 7/16				
						22 1/16				2 3/4								
	213JM			10 1/2	7 3/8	8	23 1/16	5 1/4		4 1/4	2 3/4	1/4	13/32	13 1/16	10 1/16			
	25 1/16						3 1/2											
254JM	11 1/4	8 15/16	9 1/2	28 1/2	6 1/4	5	4 1/8	1/2	17/32	14 7/16	12							
256JM																		
RC07 25	143JM	2 1/2 FLANGE	3 FLANGE	7	5 1/4	5 15/16	18 9/16	3 1/2	5 9/16	2 3/4	2	1/8	11/32	10 1/8	6 7/8	6 1/4	3	6 3/16
	19 5/16						2 1/2											
	9			5 7/8	6 1/2	19 1/2	4 1/2	3 3/4		2 1/4	3/16	13/32	10 3/4	8 7/16				
						21				2 3/4								
	213JM			10 1/2	7 3/8	8	22 1/16	5 1/4		4 1/4	2 3/4	1/4	13/32	12	10 1/16			
	24 1/16						3 1/2											
254JM	11 1/4	8 15/16	9 1/2	27 7/16	6 1/4	5	4 1/8	1/2	17/32	13 3/8	12							
256JM																		
284JM	12 1/4	12 1/4	10 3/4	28 5/16	7	5 1/2	4 3/4	1/2	17/32	13 3/8	13 5/8							
RC07 30	143JM	3 FLANGE	4 FLANGE	7	5 1/4	5 15/16	19 1/4	3 1/2	6 3/16	2 3/4	2	1/8	11/32	10 1/8	6 7/8	7	3 3/8	7 1/16
	20 1/16						2 1/2											
	9			5 7/8	6 1/2	20 1/4	4 1/2	3 3/4		2 1/4	3/16	13/32	10 3/4	8 7/16				
						21 3/4				2 3/4								
	213JM			10 1/2	7 3/8	8	22 13/16	5 1/4		4 1/4	2 3/4	1/4	13/32	12	10 1/16			
	24 13/16						3 1/2											
	254JM			11 1/4	8 15/16	9 1/2	28 3/16	6 1/4		5	4 1/8	1/2	17/32	13 3/8	12			
	256JM																	
	284JM			12 1/4	12 1/4	10 3/4	29 1/16	7		5 1/2	4 3/4	1/2	17/32	13 3/8	13 5/8			
	286JM																	
324JM	13 3/16	13 3/16	12	31 9/16	8	6 1/4	5 1/4	3/4	21/32	17 7/8	15 9/16							
13 1/2			32 9/16	6														

SELECTION CURVES

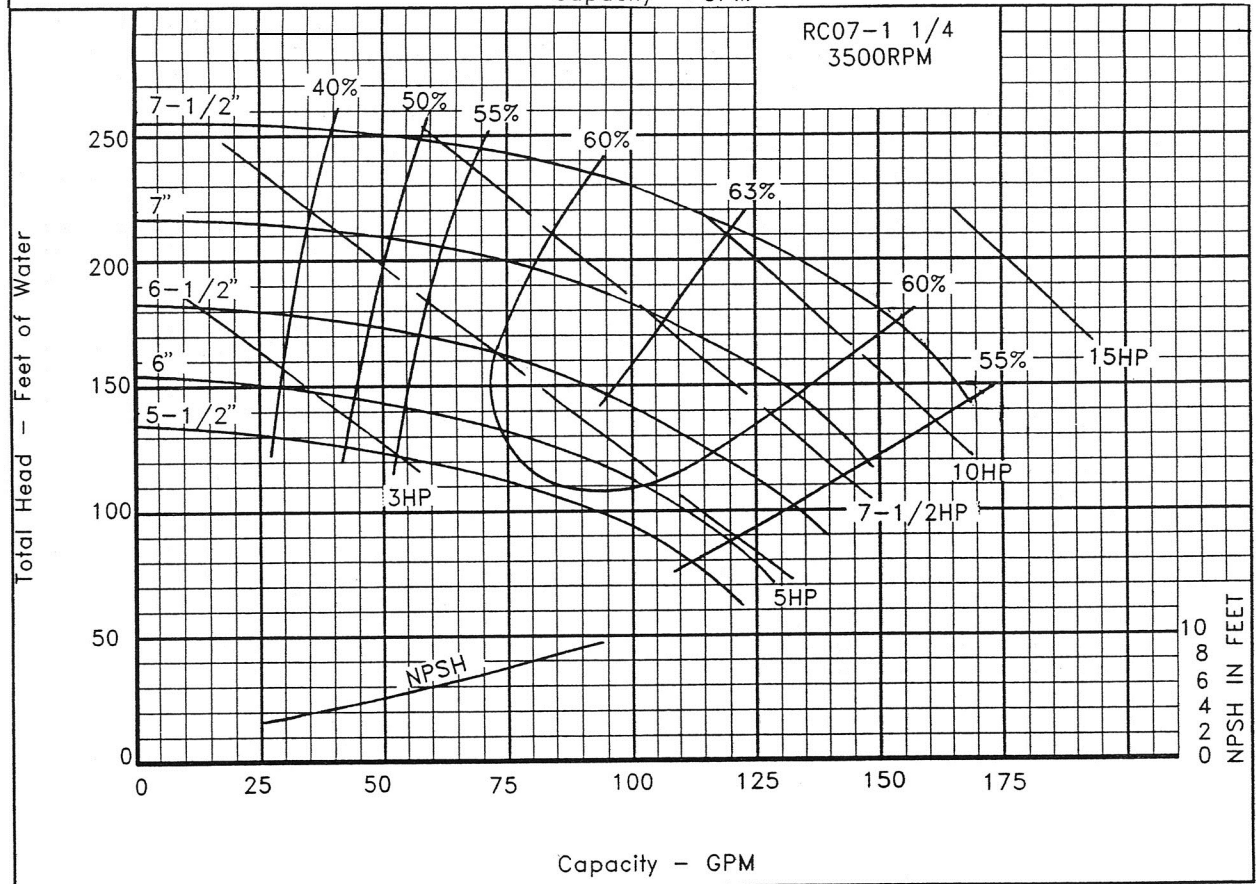
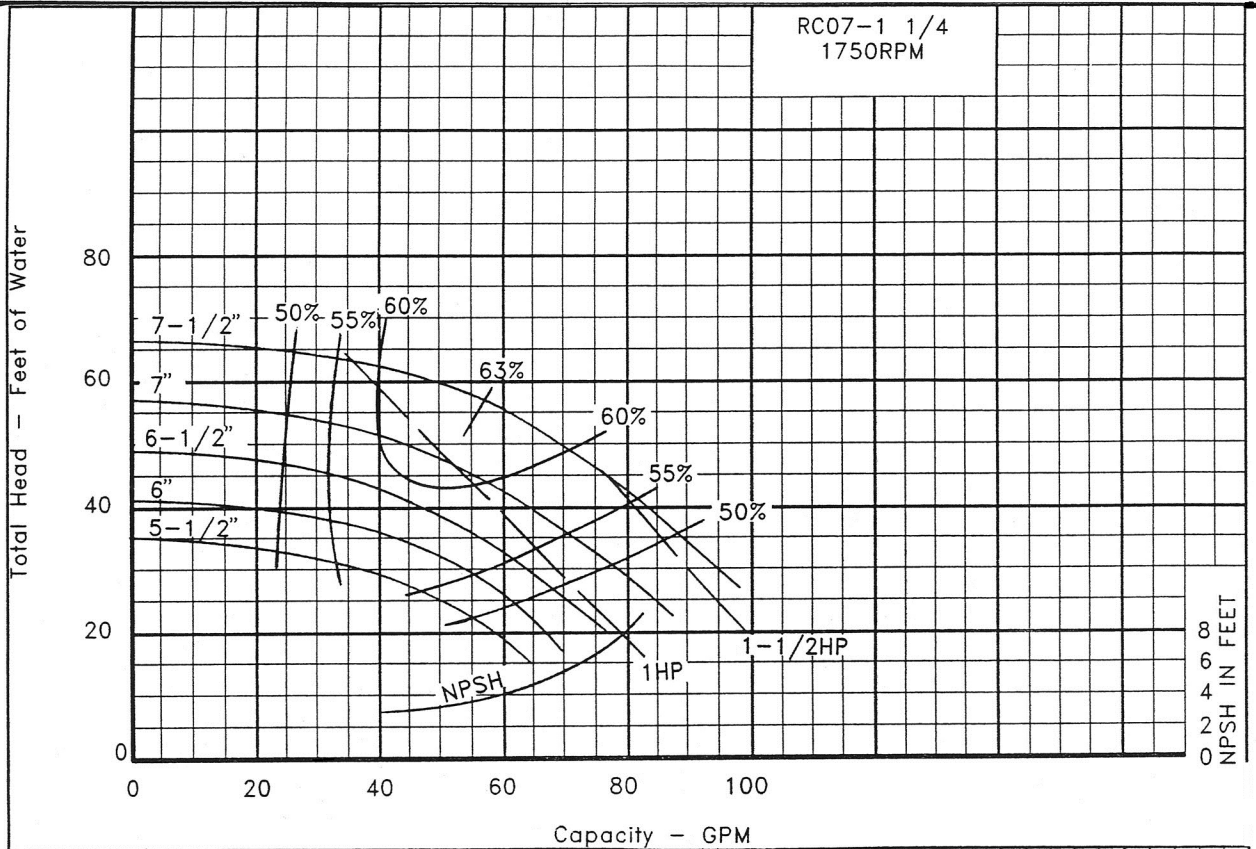

NOTE

Computerized pump curves are available for sizing, Pump Flo[™] program.

SELECTION CURVES

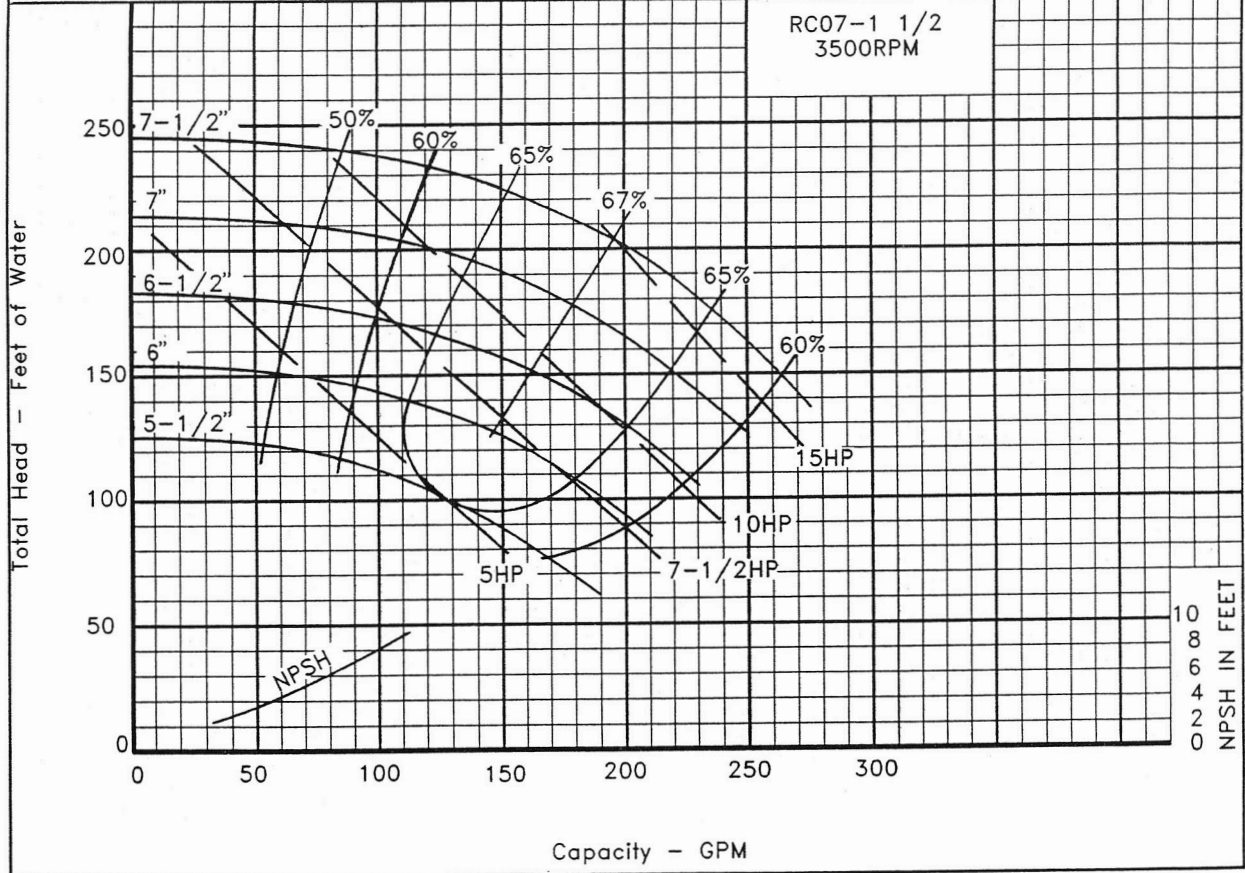
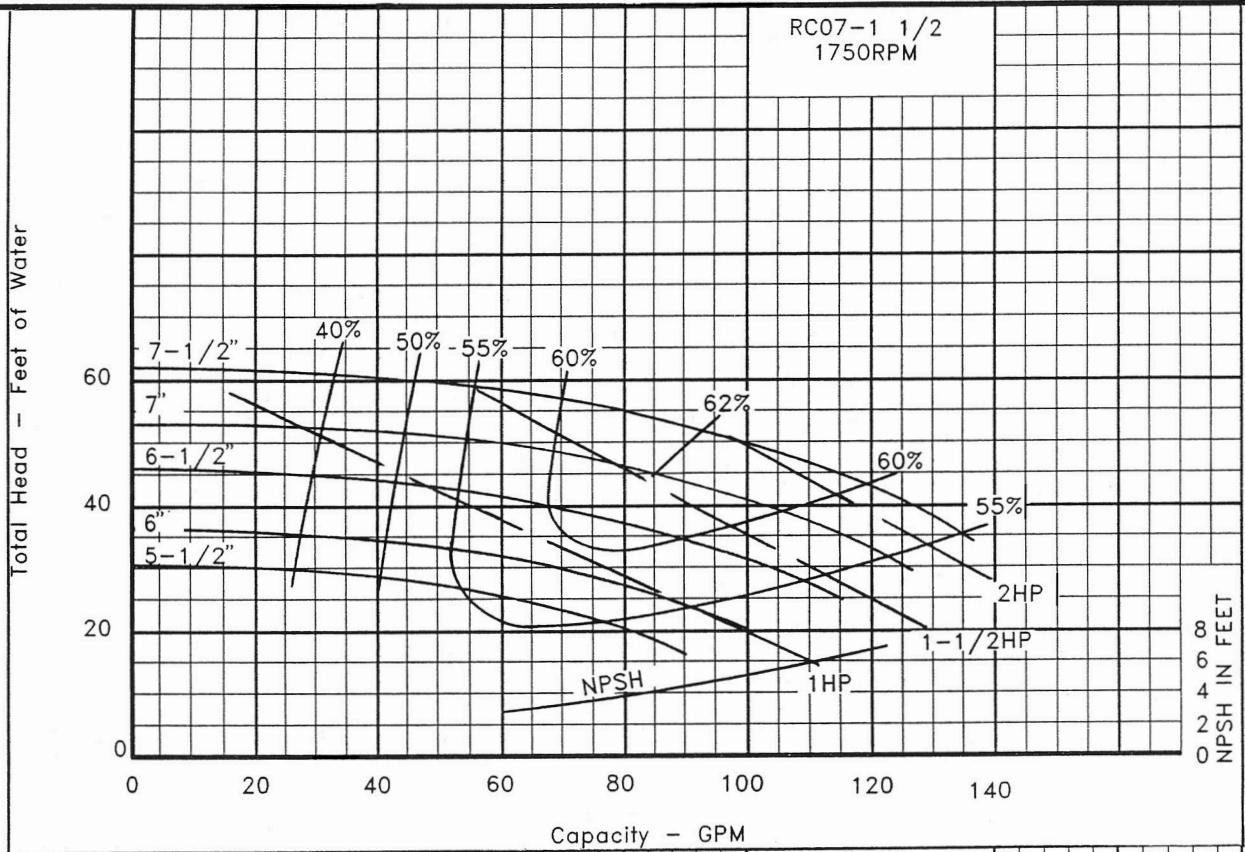

NOTE

Computerized pump curves are available for sizing, Pump Flo™ program.

SELECTION CURVES

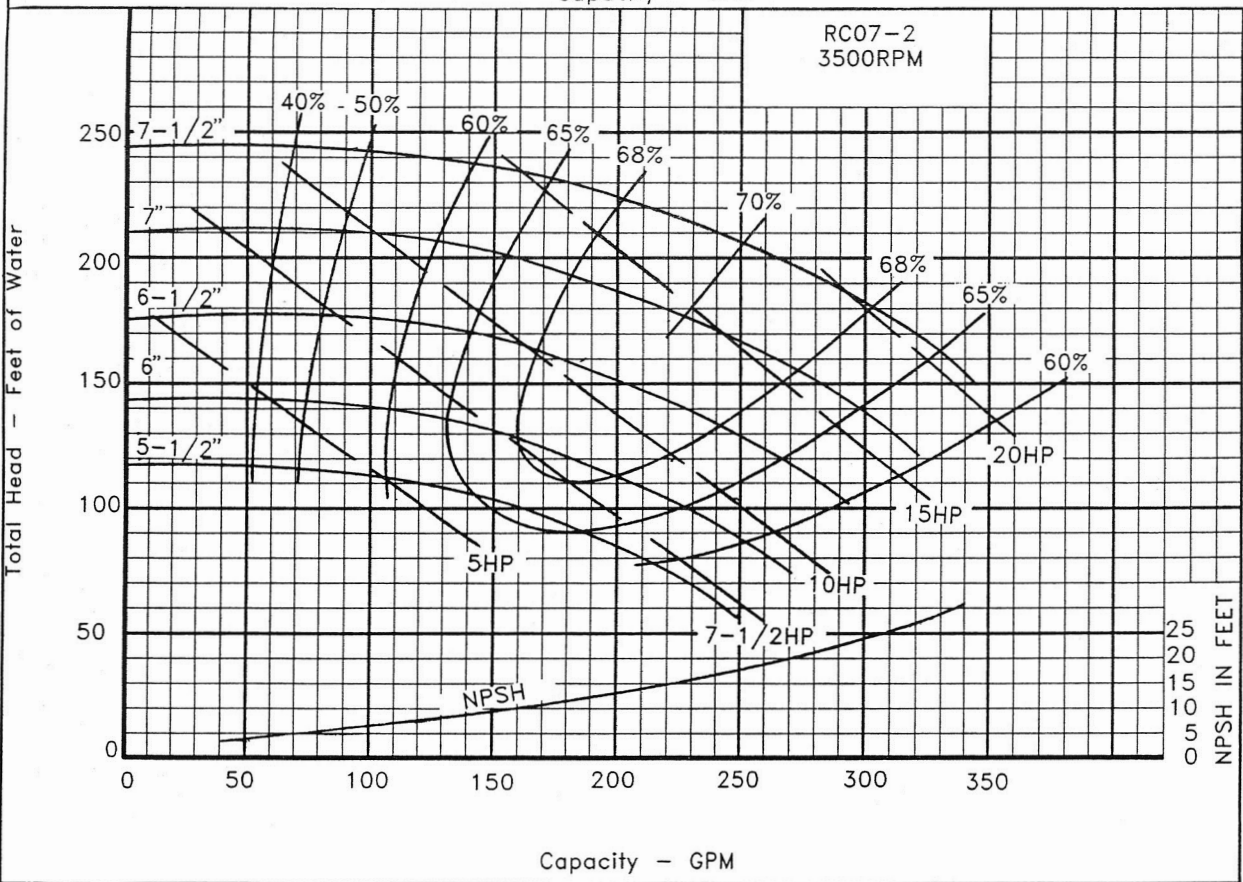
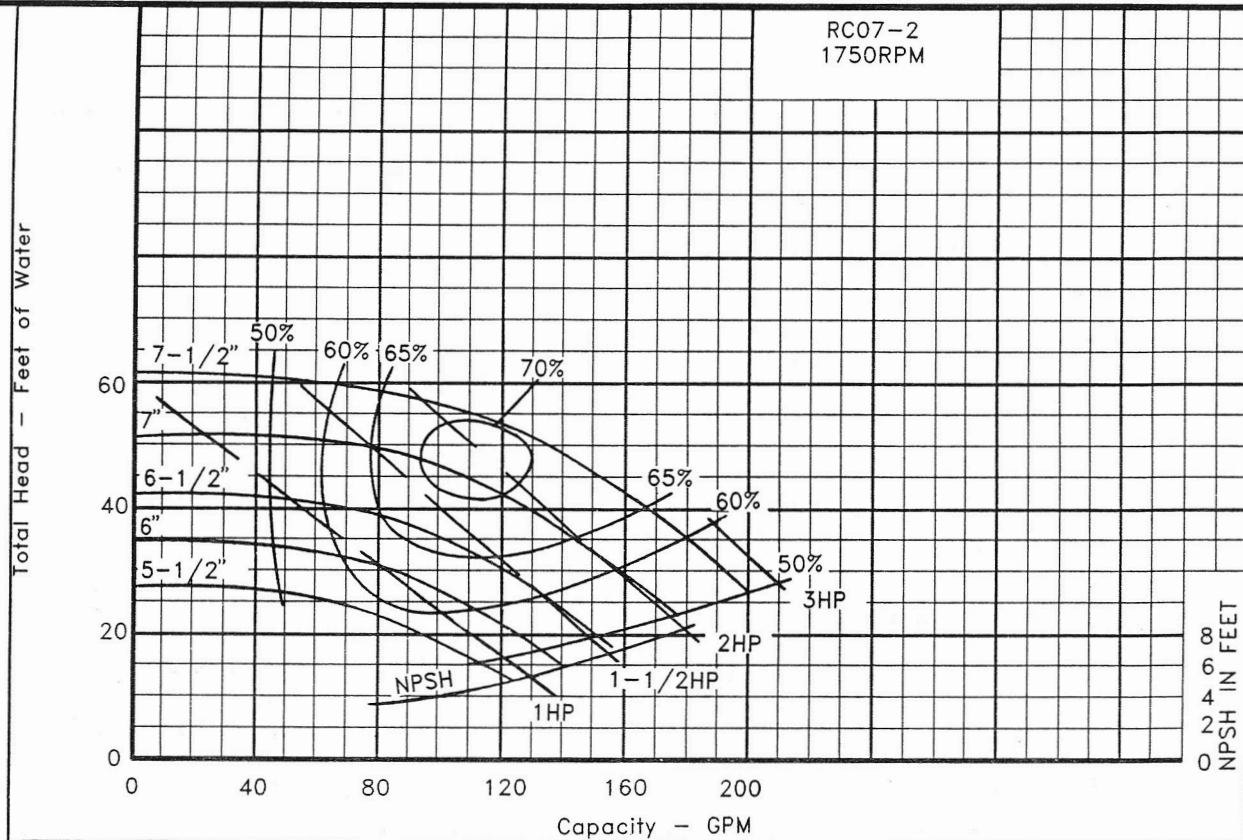

NOTE

Computerized pump curves are available for sizing, Pump Flo[™] program.

SELECTION CURVES

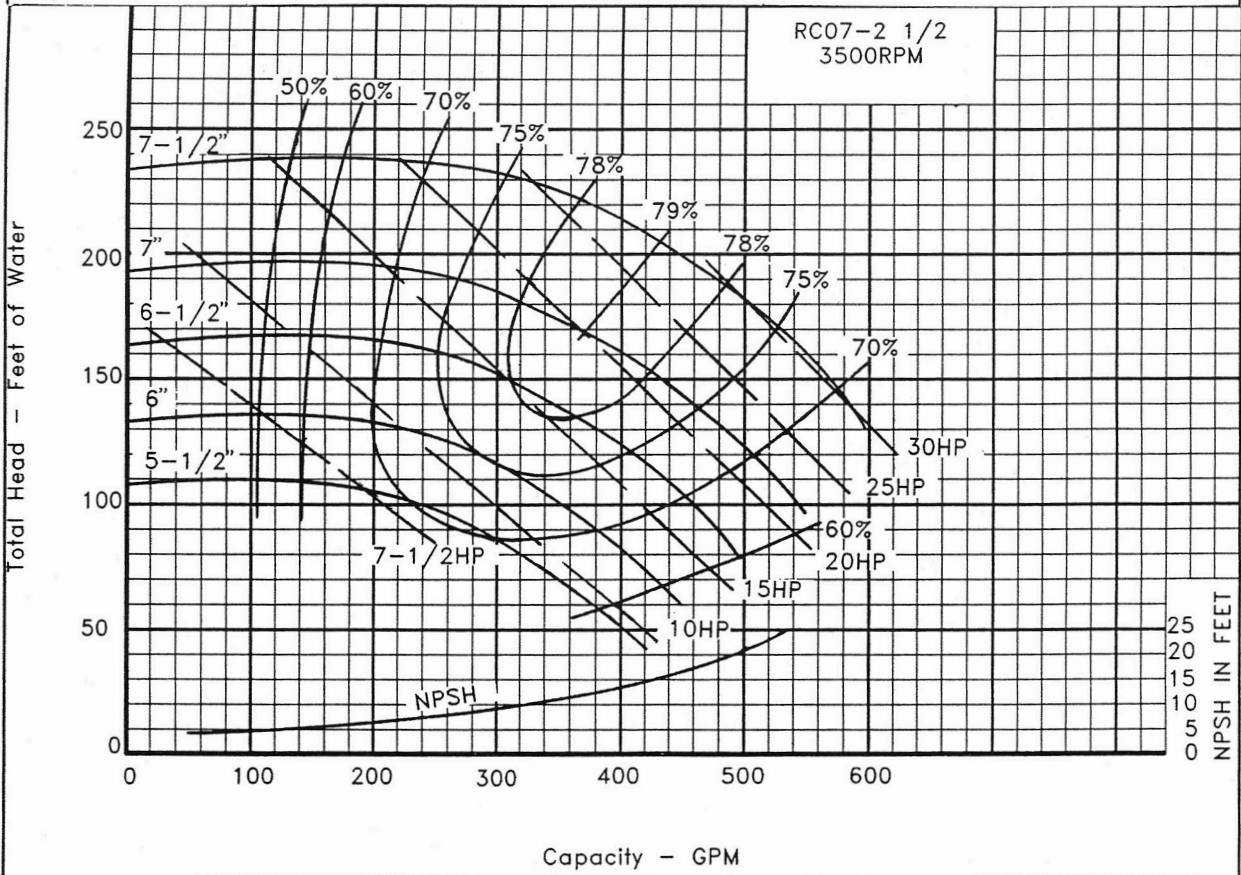
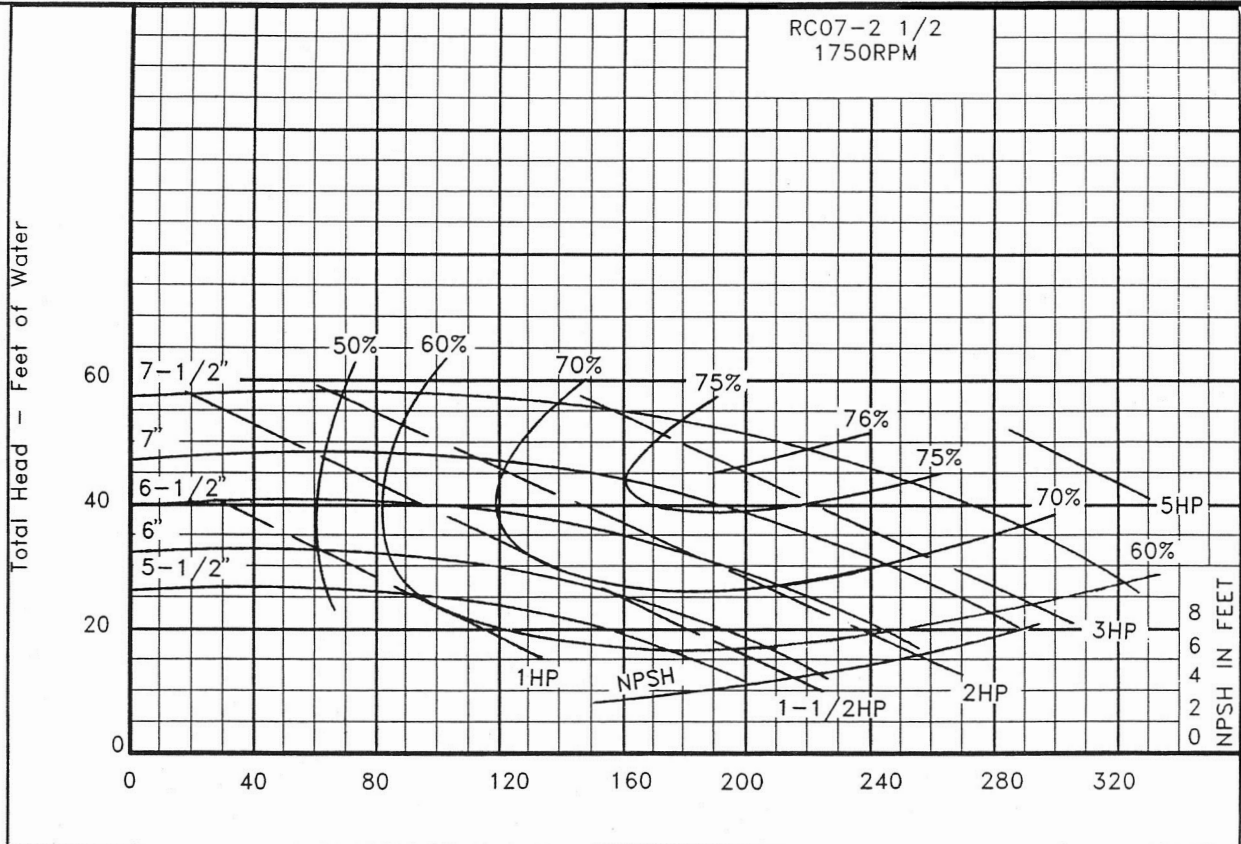

NOTE

Computerized pump curves are available for sizing, Pump Flotm program.

SELECTION CURVES

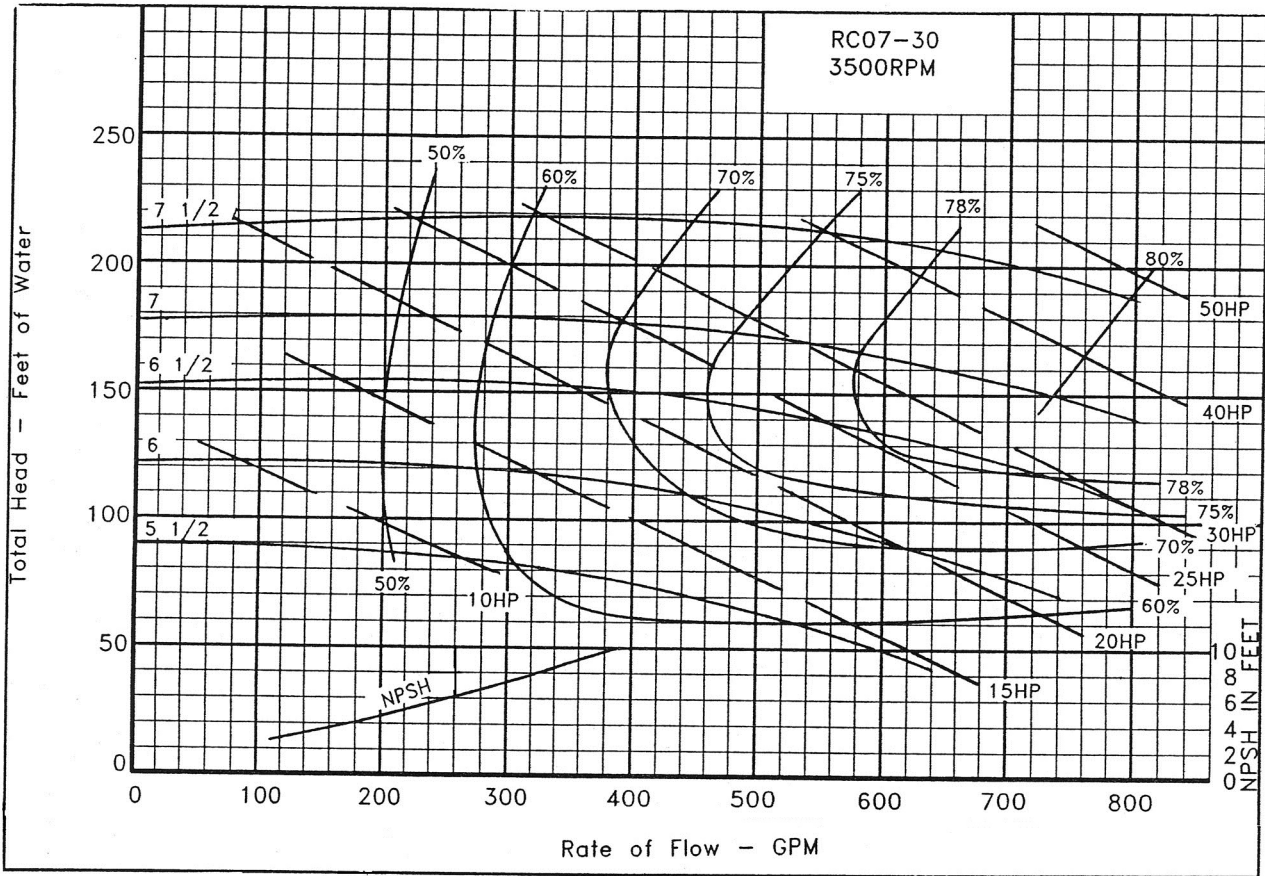

NOTE

Computerized pump curves are available for sizing, Pump Flo[™] program.

SELECTION CURVES

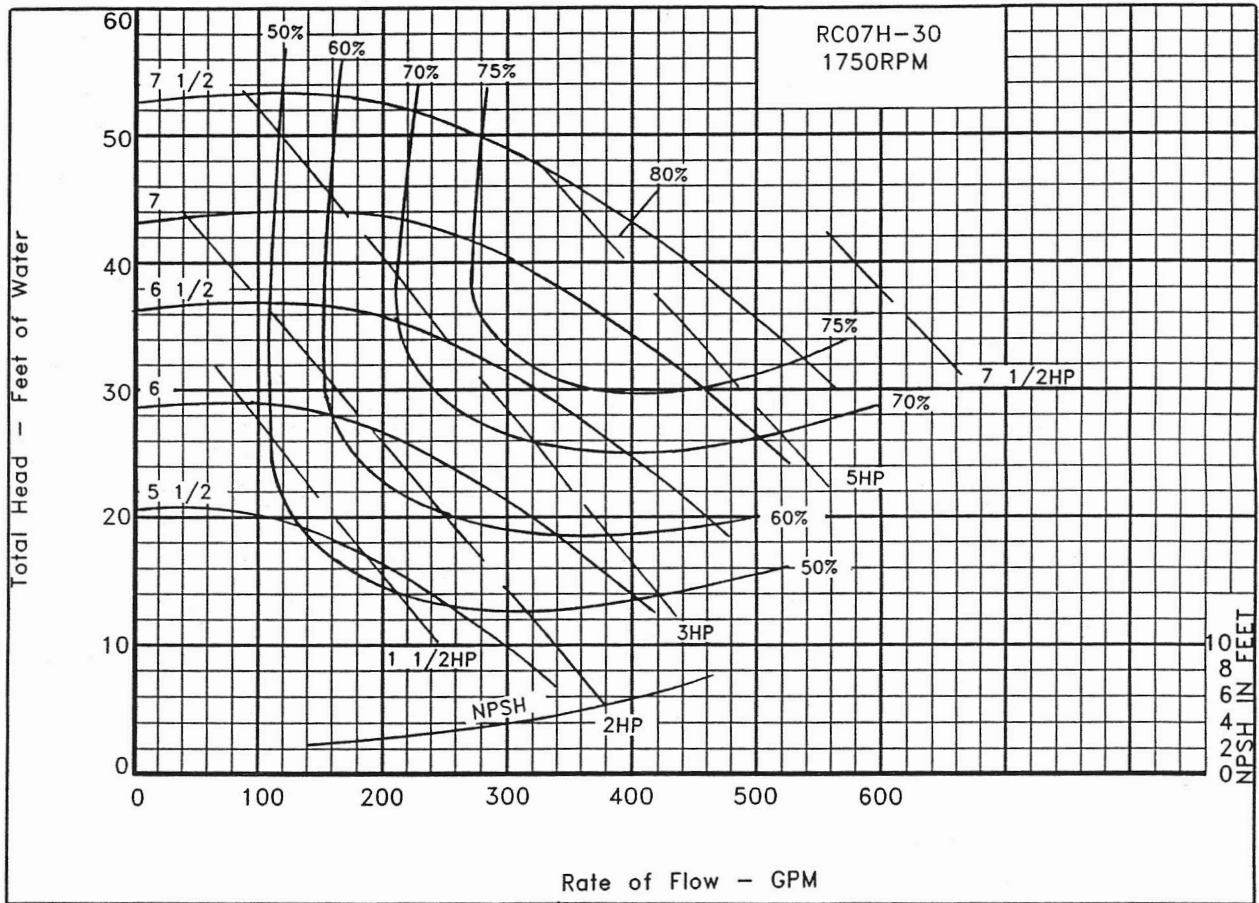

TYPICAL SPECIFICATIONS

- Furnish and install pumps with capacities as shown on plans. Pumps shall be MEPCO close coupled, single-stage, vertically-split case design, capable of being serviced without disturbing piping connections. Pump volute shall be Class 30 cast iron, and impeller shall be bronze enclosed type, dynamically balanced.
- Seal shaft shall be of rotary type and suitable for water temperatures up to 250 degrees Fahrenheit.
- Pumps shall be rated for minimum of 175 PSI working pressure. Casings shall have vent and drain ports at top and bottom casing.
- Motor shall meet NEMA specifications and shall be of the size, voltage and enclosure called for on the plans. It shall have heavy-duty ball bearings, completely adequate for the maximum load for which the motor is designed.
- Each pump shall be factory tested and thoroughly cleaned and painted with high-grade lacquer prior to shipment.
- Each pump shall be checked by the contractor and regulated for proper differential pressure, voltage and amperage draw. This data shall be noted on a permanent tag or label and fastened to pump for owner's reference. Pumps shall be Series RC07 manufactured by MEPCO.



3695 44th Street SE, Grand Rapids, Michigan 49512

Phone 616.971.3420 Fax 616.971.3421

www.mepcollc.com