



Refrigerated Glass Door Merchandisers

One (1) and Two (2) Door Merchandisers

Customer Service: 917-818-6899 | Service/Warranty: 1-866-972-3352
 www.PadelaEquipment.com | Sales@PadelaEquipment.com | Service@PadelaEquipment.com



MODELS: PDG-1R-HC
 PDG-2R-HC
 PDSG-2R-HC

FEATURES:

- ☑ Stainless Steel exterior & interior
- ☑ LED interior lights
- ☑ Heavy Duty Embraco compressor with environmentally friendly R290 refrigerant
- ☑ Dixell digital controller
- ☑ Maintains temperatures between 33°F – 38°F
- ☑ Self-closing door(s) with automatic stay open feature
- ☑ Recessed door handle
- ☑ Magnetic door gasket
- ☑ Double Pane glass door
- ☑ Pre-installed casters
- ☑ NEMA-5-15P plug standard
- ☑ Four (4) Pre-installed Shelves per section

OPTIONAL FEATURES:

- ☑ Extra Shelves – includes 4 shelf clips per shelf

DIMENSIONS:

	Width	Depth	Height	Weight
PDG-1R-HC	27	x 31 ^{1/2}	x 83 ^{1/8}	326
PDG-2R-HC	54 ^{3/8}	x 31 ^{1/2}	x 83 ^{1/8}	540
PDSG-2R-HC	54 ^{3/8}	x 29 ^{3/4}	x 81 ^{1/4}	511

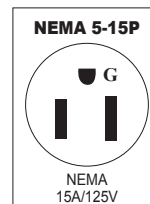



"Where a Great Kitchen Begins"

Refrigerated Glass Door Merchandisers

One (1) and Two (2) Door Merchandisers

Customer Service: 917-818-6899 | Service/Warranty: 1-866-972-3352
 www.PadelaEquipment.com | Sales@PadelaEquipment.com | Service@PadelaEquipment.com

SPECIFICATIONS

Model	Doors	Cu.Ft	Shelves	Exterior Dimensions (WxDxH)	Castors	Weight (lbs)	Voltage	HP	Amps	Refrigerant
PDG-1R-HC	1	19.1	4	27 x 31 ^{1/2} x 83 ^{1/8}	4inch	326 lbs	1/7	115/60/1	2.1	R-290
PDG-2R-HC	2	44.77	8	54 ^{3/8} x 31 ^{1/2} x 83 ^{1/8}	4inch	540 lbs	1/5	115/60/1	3.2	R-290
PDSG-2R-HC	2	44.85	8	54 ^{3/8} x 29 ^{3/4} x 81 ^{1/4}	2inch	511 lbs	1/4	115/60/1	4.2	R-290

LINE DRAWINGS

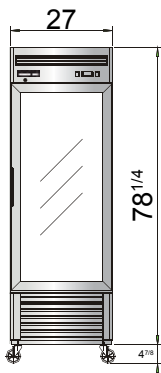
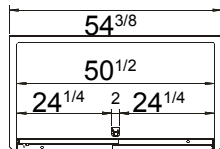
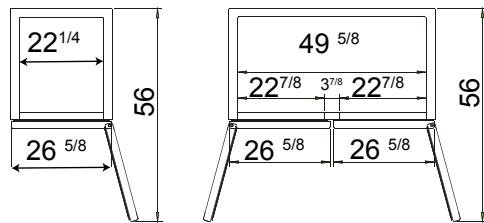

PDG-1R-HC

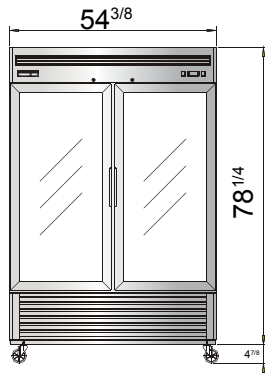

PDG-2R-HC

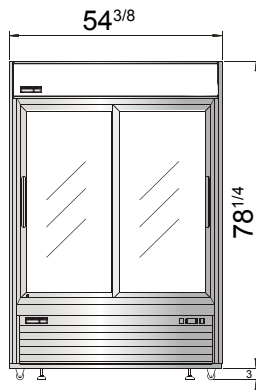

PDSG-2R-HC

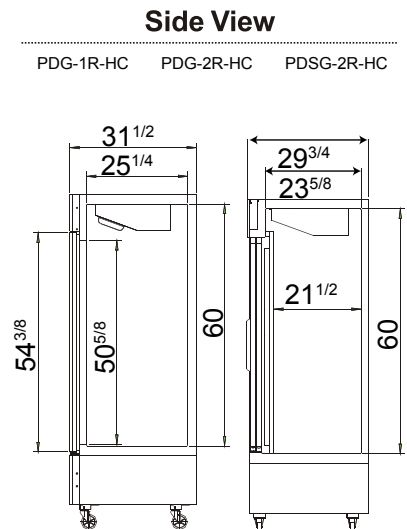

Temperature Control



Epoxy Shelves



Door Lock



Castors

