

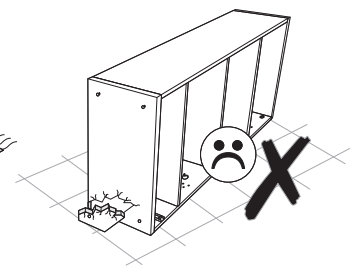

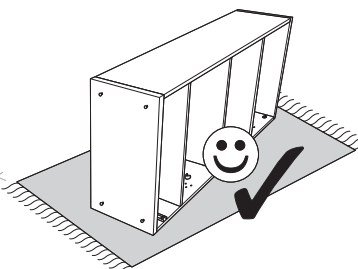

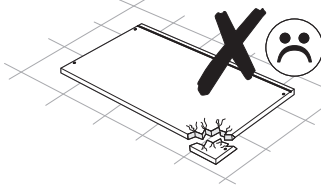

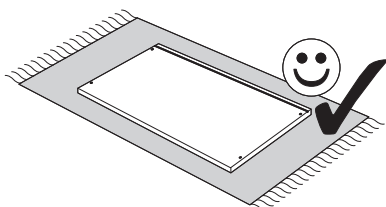

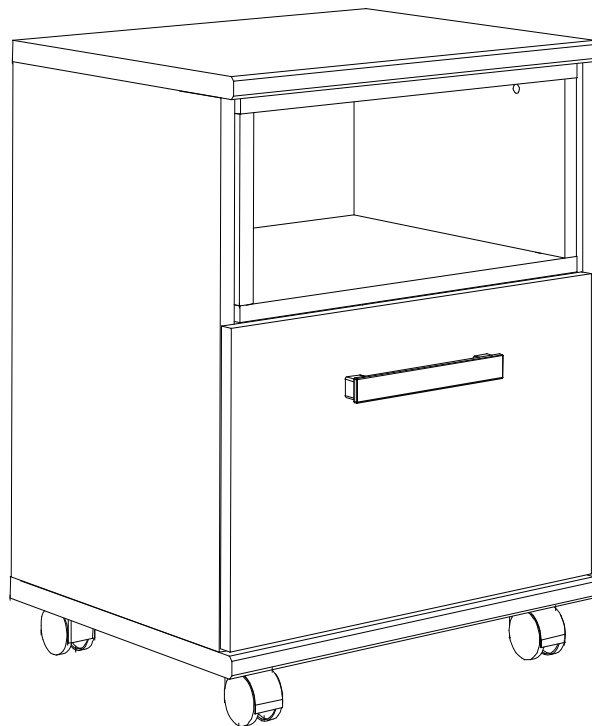
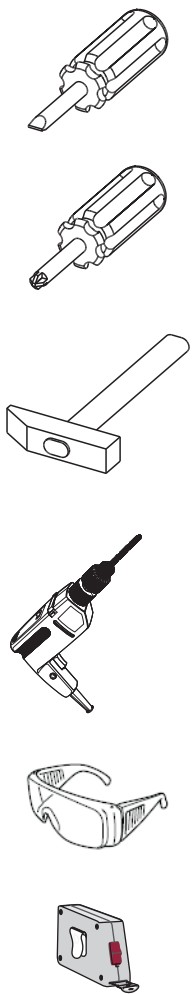
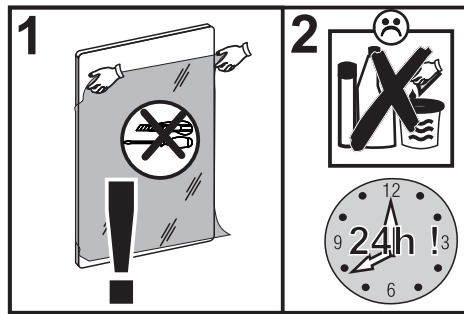
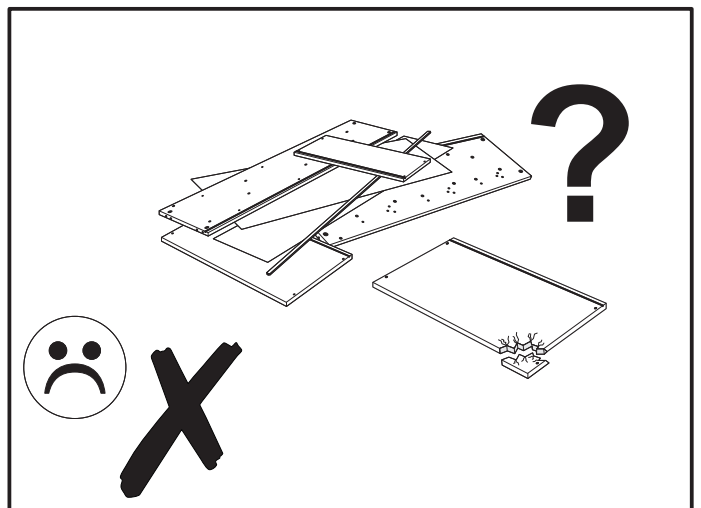
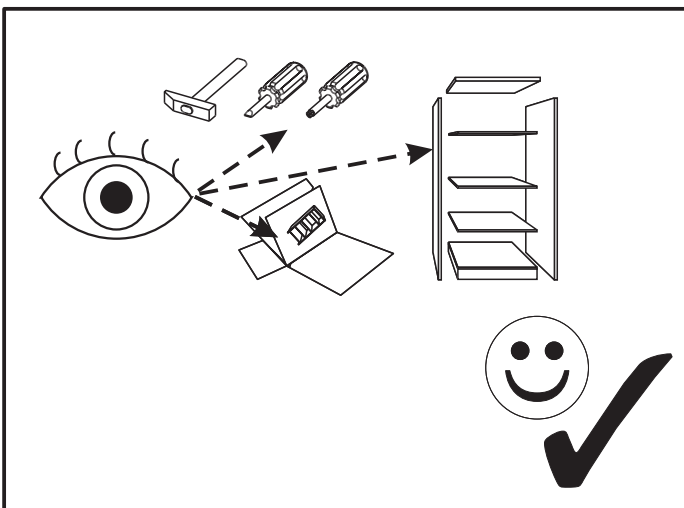
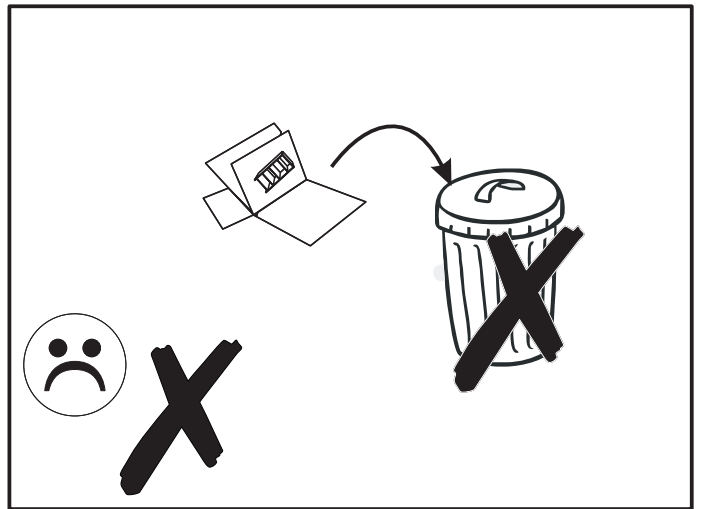
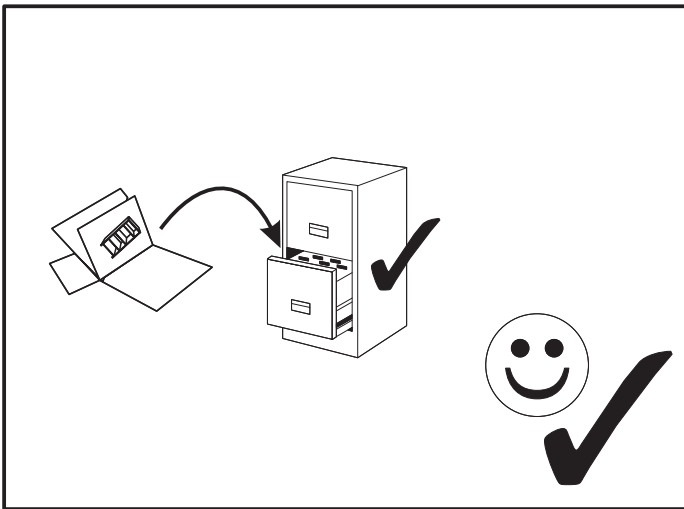
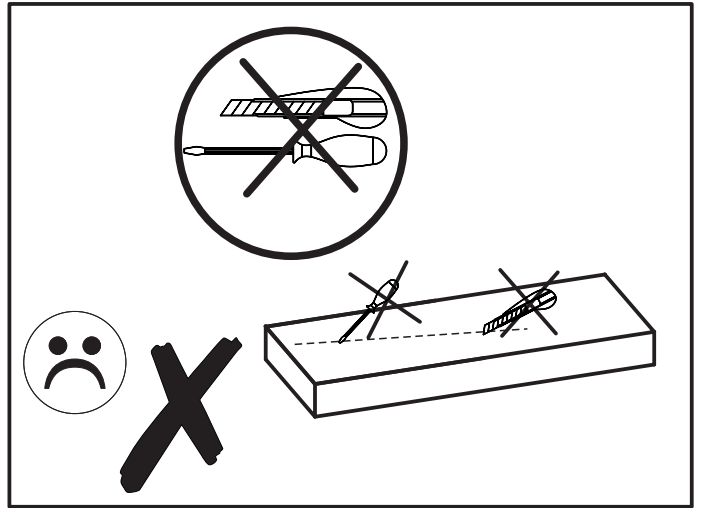
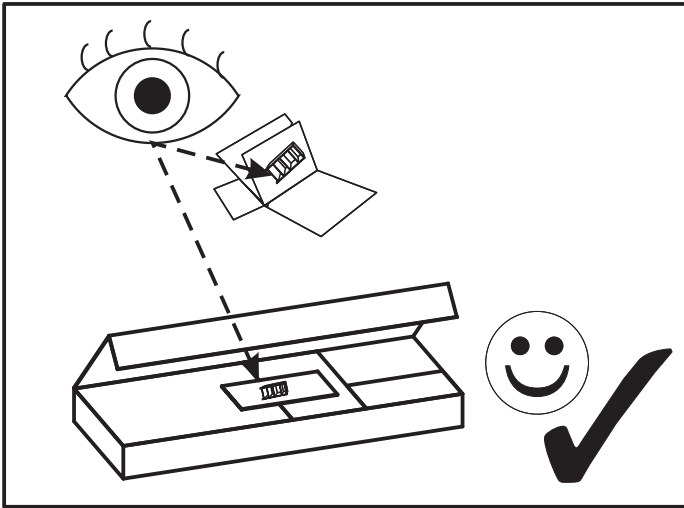
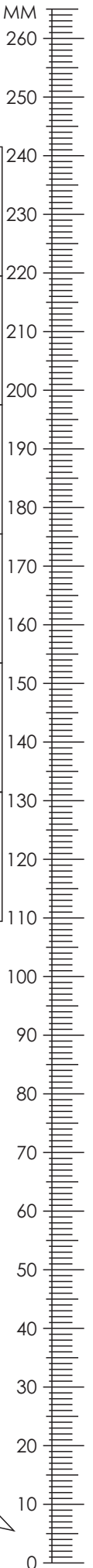



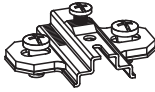



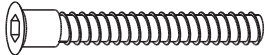
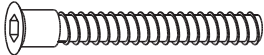

# AMAZON TYP85



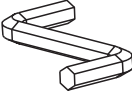

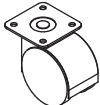
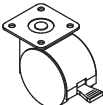
# AMAZON TYP85



<p><b>A1</b> x26 <math>\varnothing 8 \times 35</math> mm</p> 	<p><b>B0</b> x2</p> 	<p><b>B1</b> x2</p> 
<p><b>C1</b> x4 EURO 4 x 13 mm</p> 	<p><b>E0</b> x4</p> 	<p><b>E1</b> x8 <math>\varnothing 15 \times 12</math> mm</p> 
<p><b>F1</b> x8</p> 	<p><b>G0</b> x6</p> 	<p><b>G1</b> x4 <math>\varnothing 7 \times 50</math> mm</p> 
<p><b>G2</b> x4 <math>\varnothing 7 \times 60</math> mm</p> 	<p><b>H1</b> x1</p> 	<p><b>I2</b> x16 4 x 16 mm</p> 
<p><b>K3</b> x2 M4 x 22 mm</p> 	<p><b>M</b> x1</p> 	<p><b>N1</b> x10 3 x 16 mm</p> 
<p><b>O14</b> x2</p> 	<p><b>O16</b> x2</p> 	<p><b>P0</b> x6 <math>\varnothing 5</math></p> 
<p><b>P14</b> x4 <math>\varnothing 10</math></p> 	<p><b>R8</b> x2</p> 	

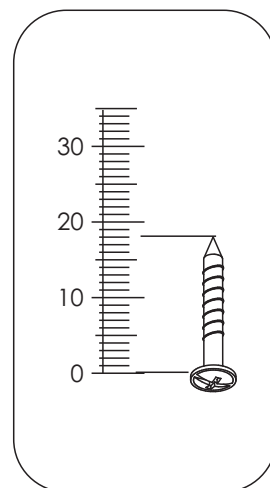

# AMAZON TYP85

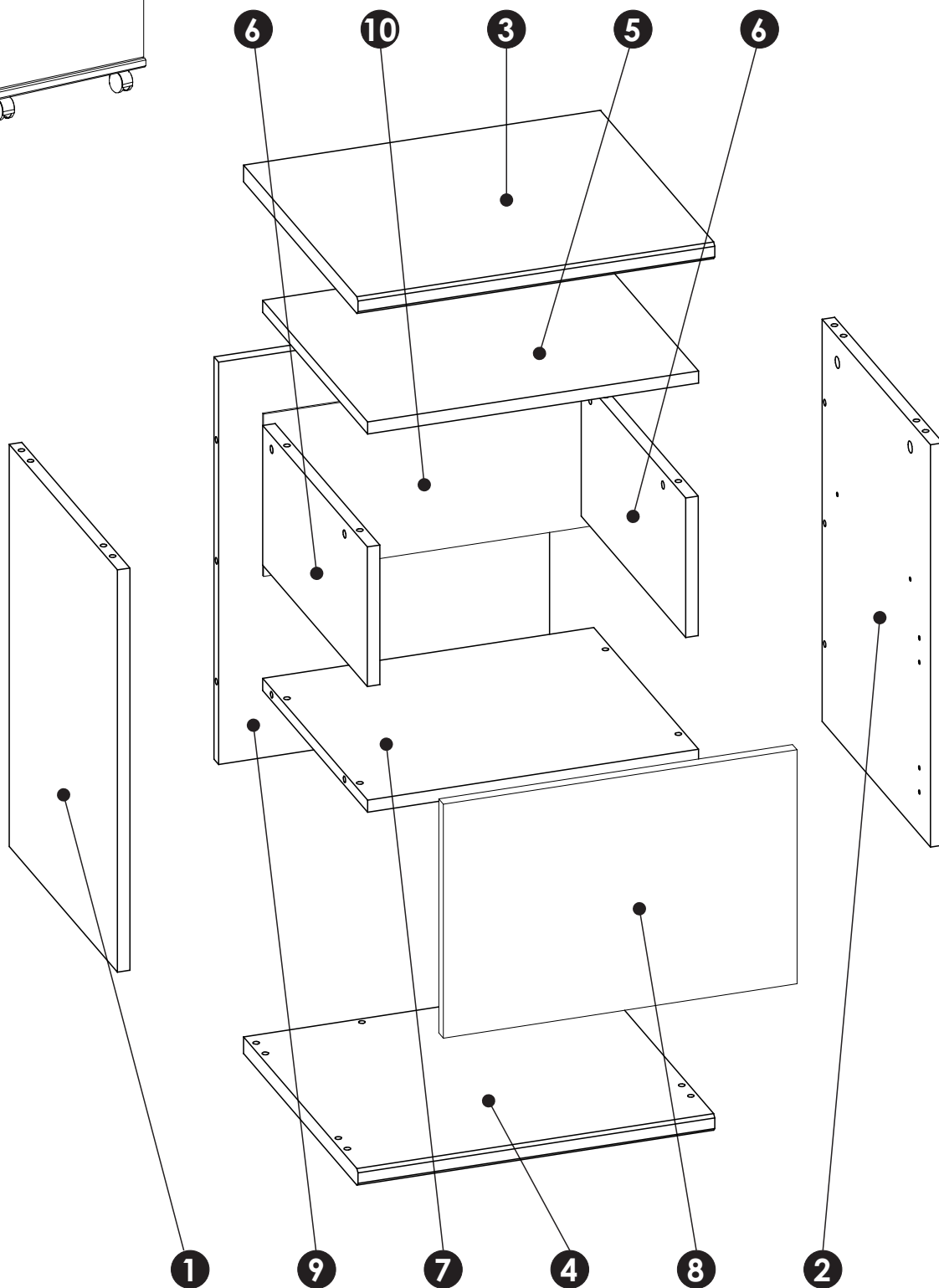
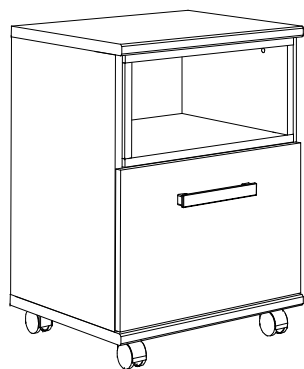

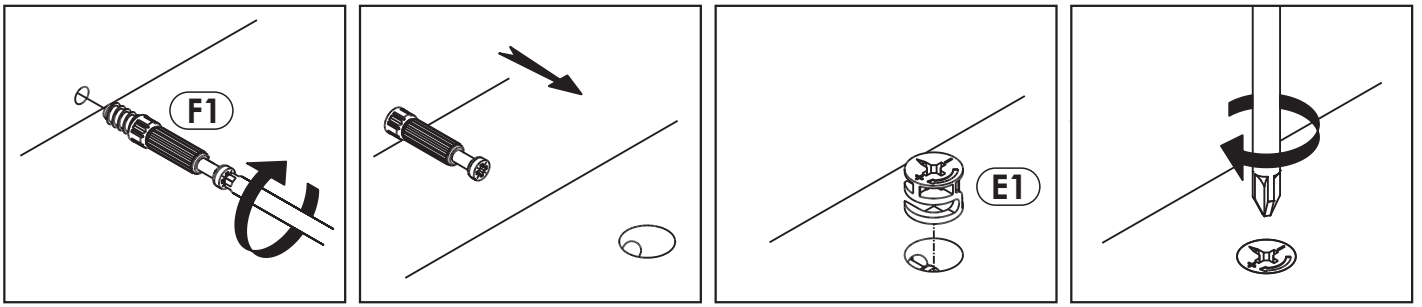

1 ▶

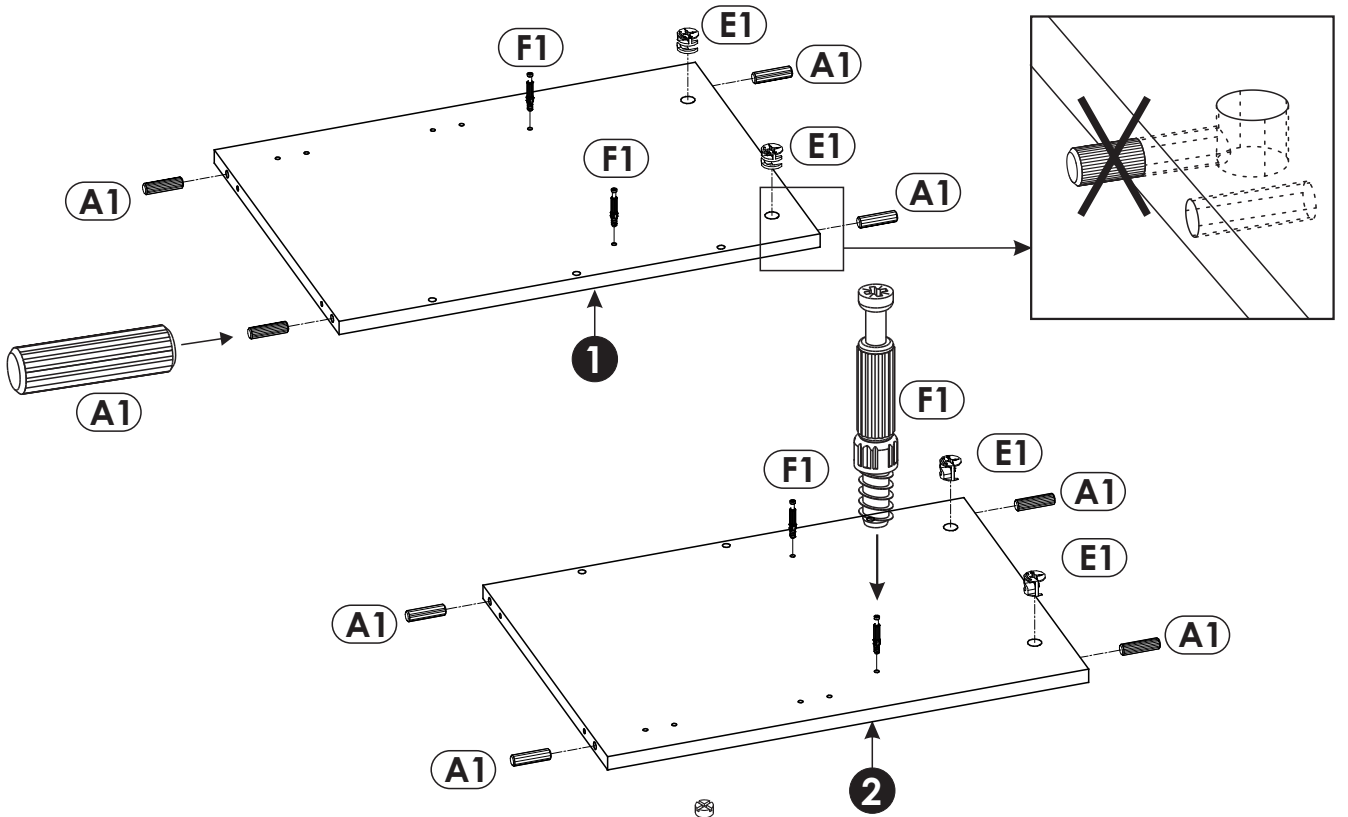

2 ▶

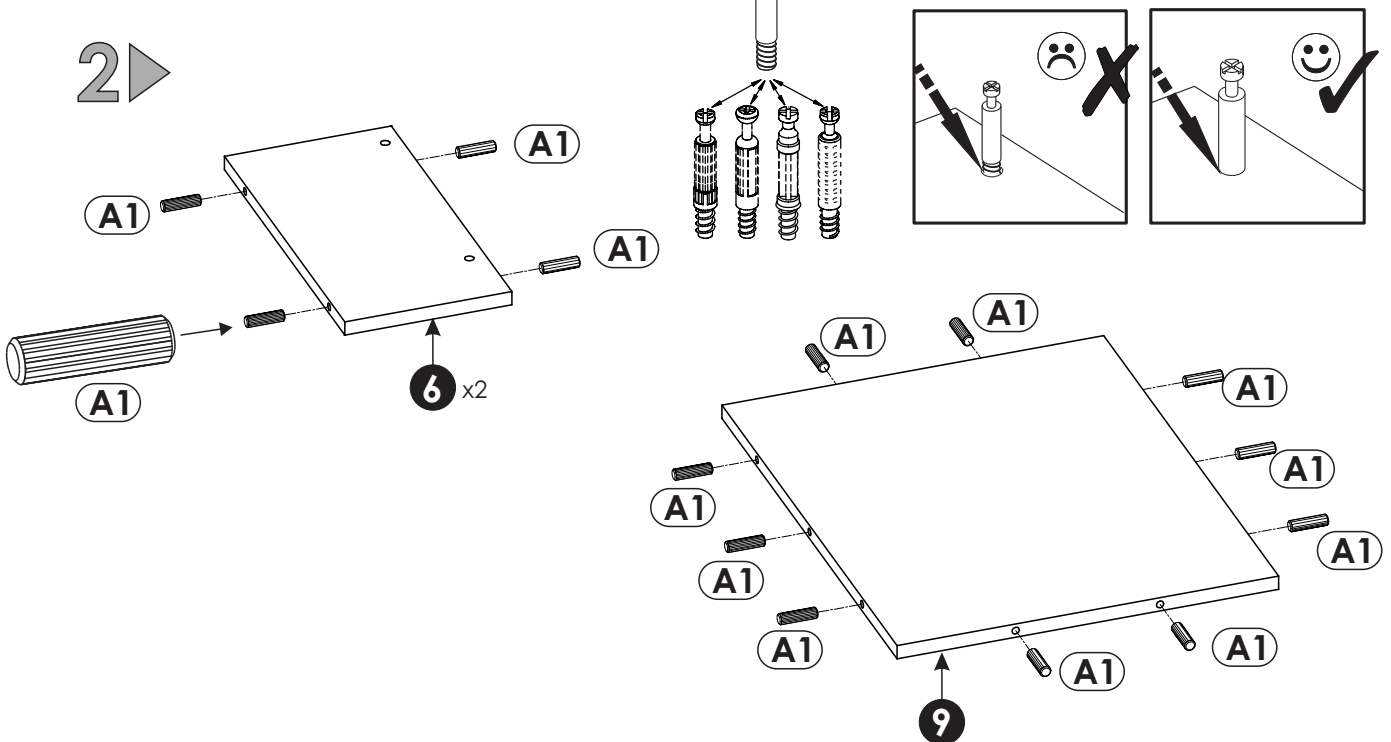

3 ▶

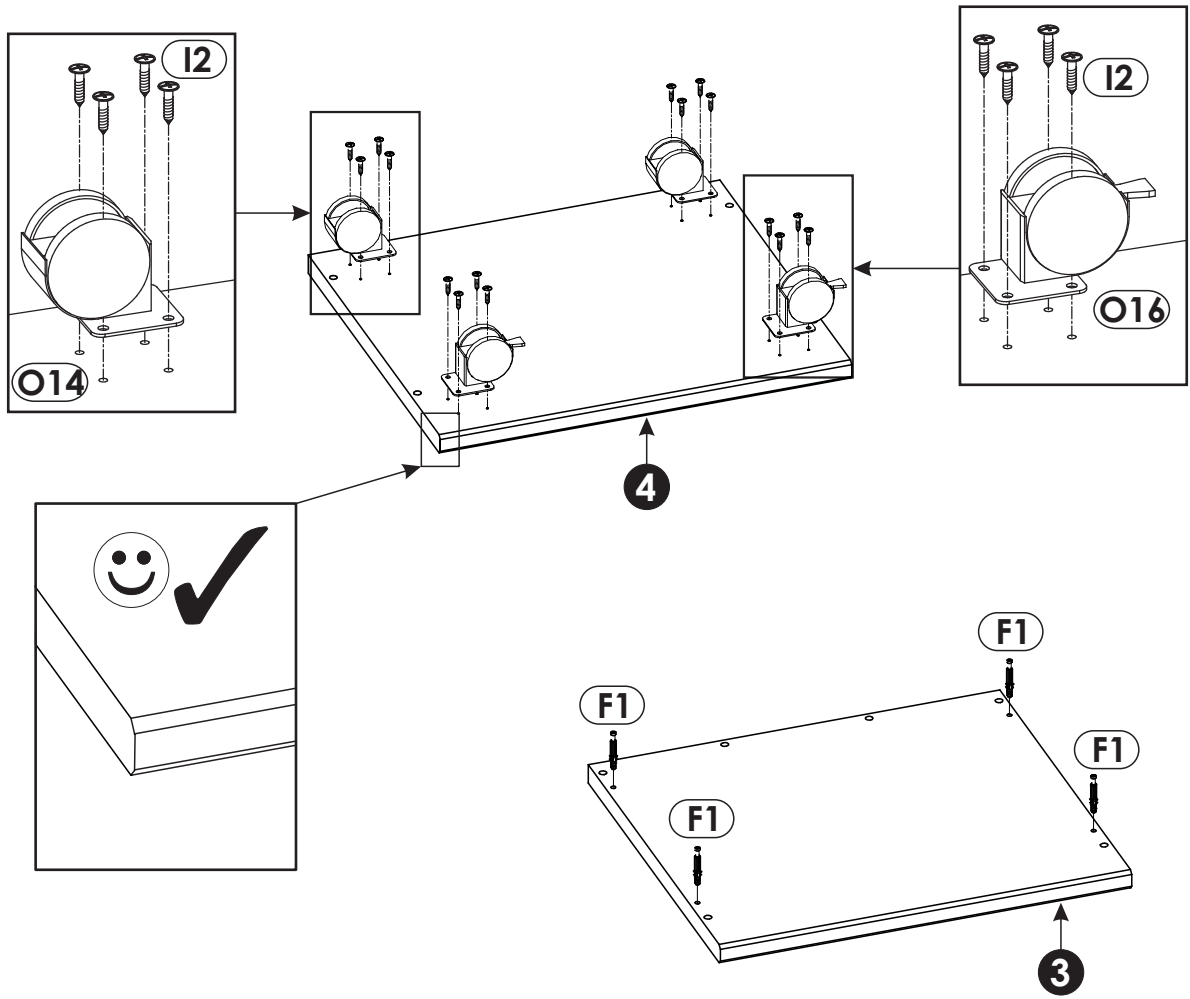

4 ▶

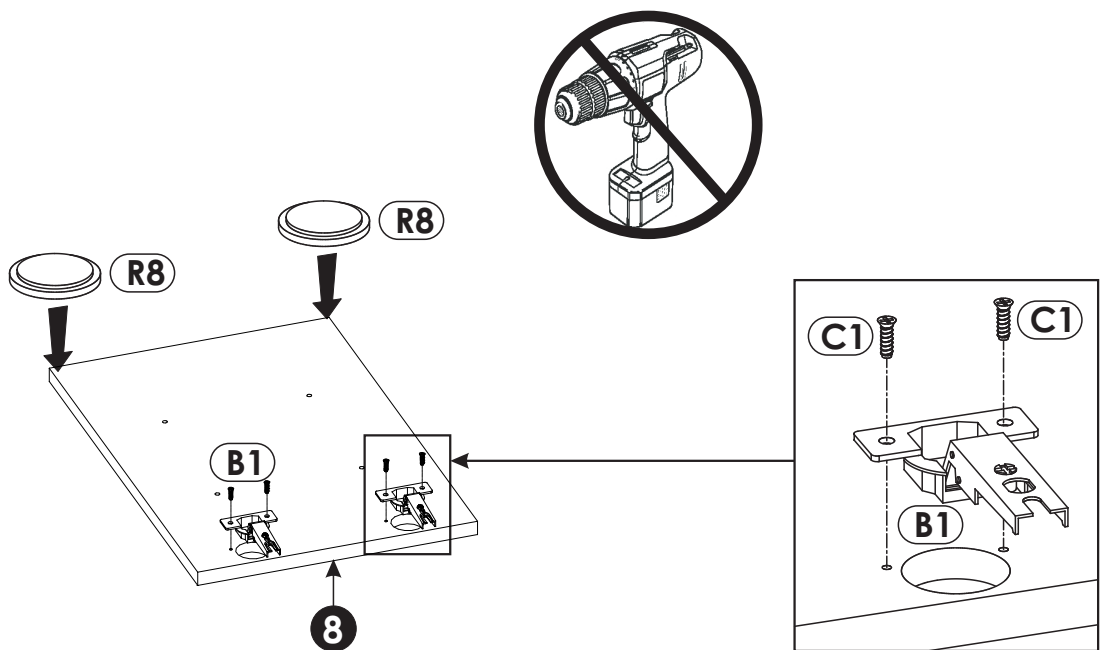

5 ▶

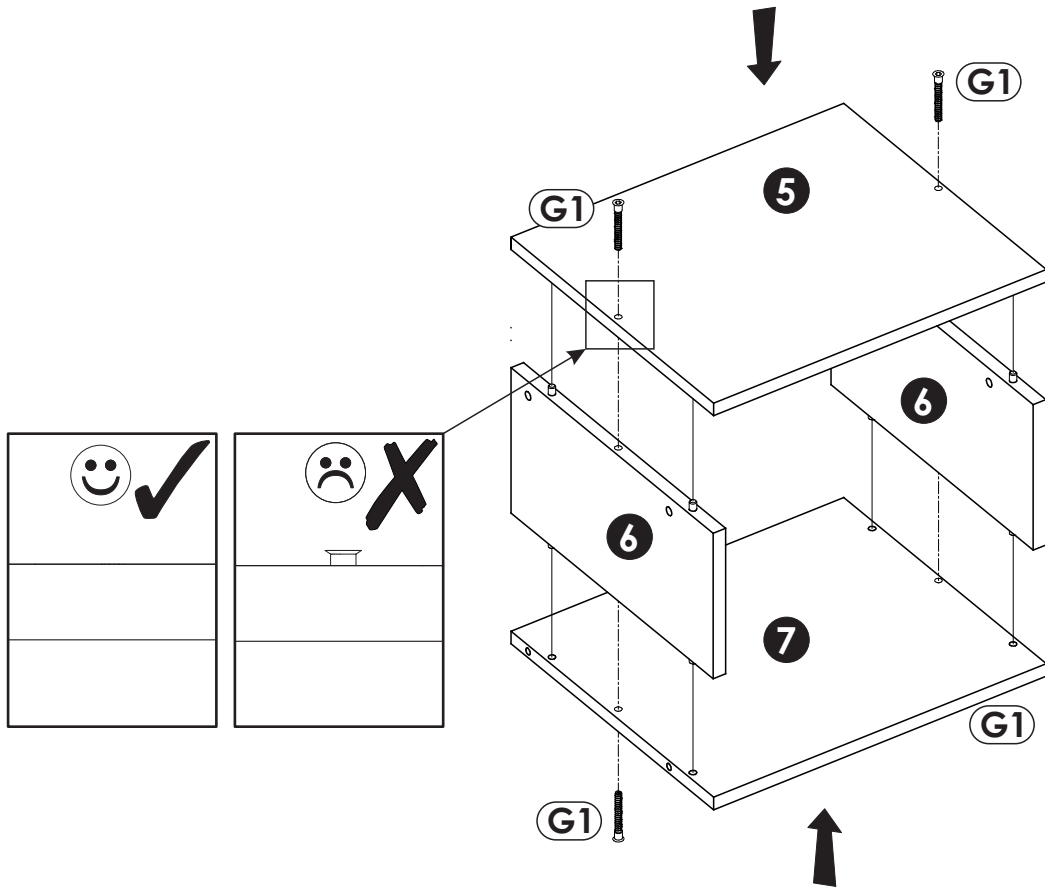

6 ▶

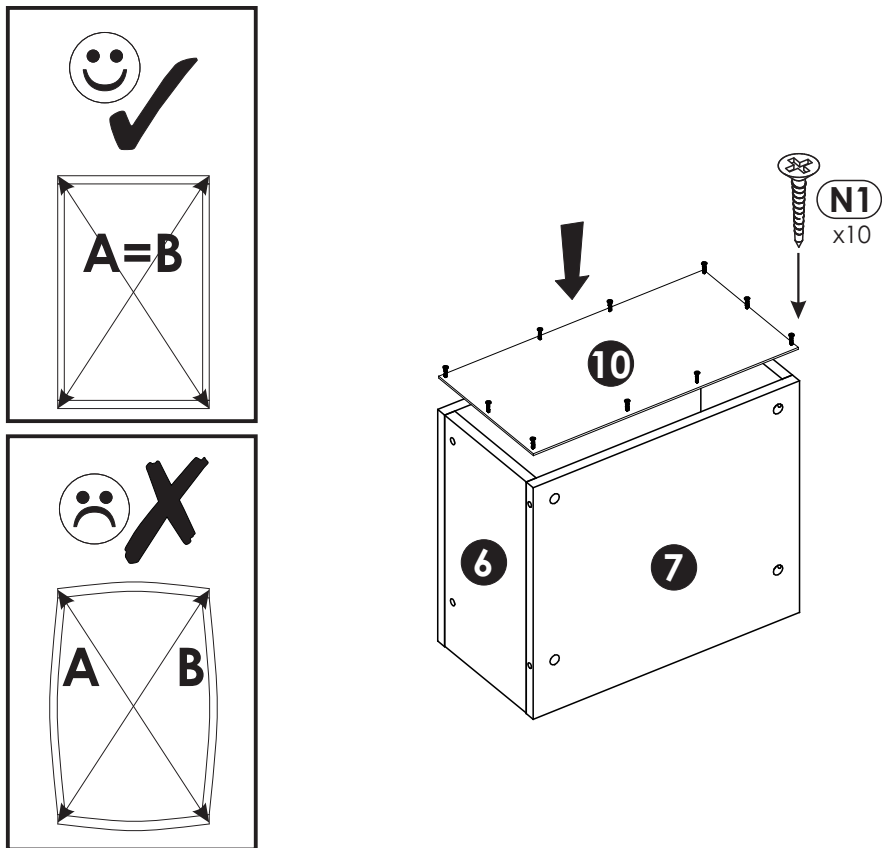

7 ▶

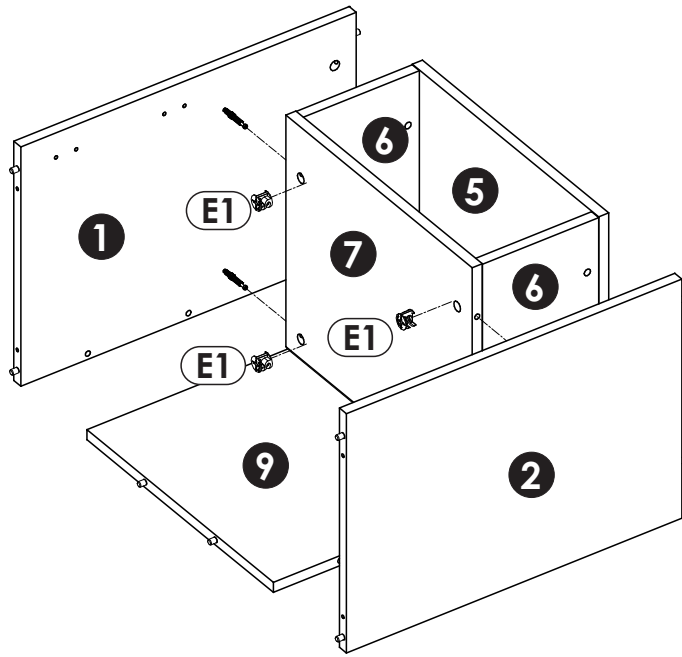

8 ▶

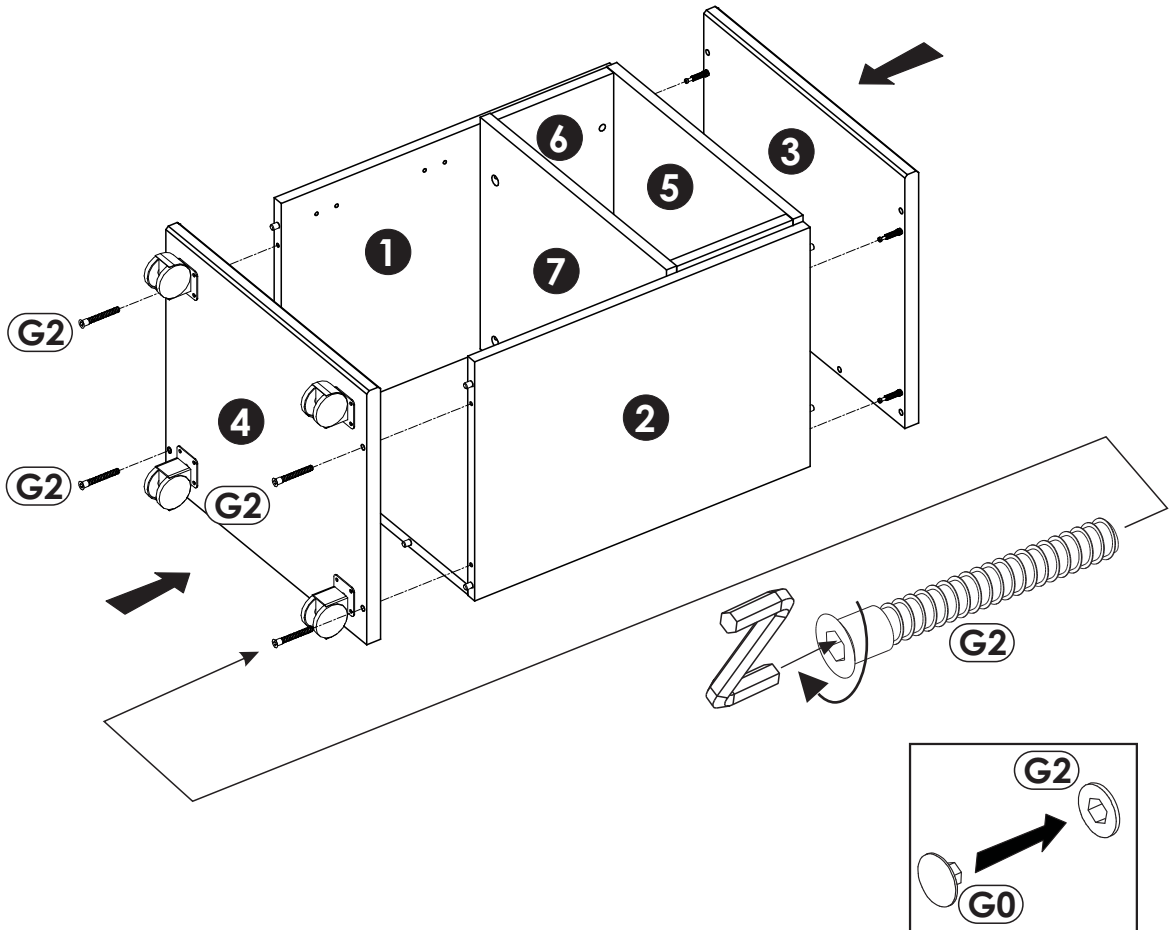



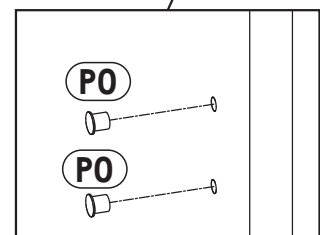
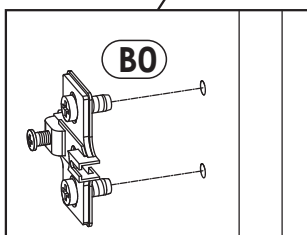
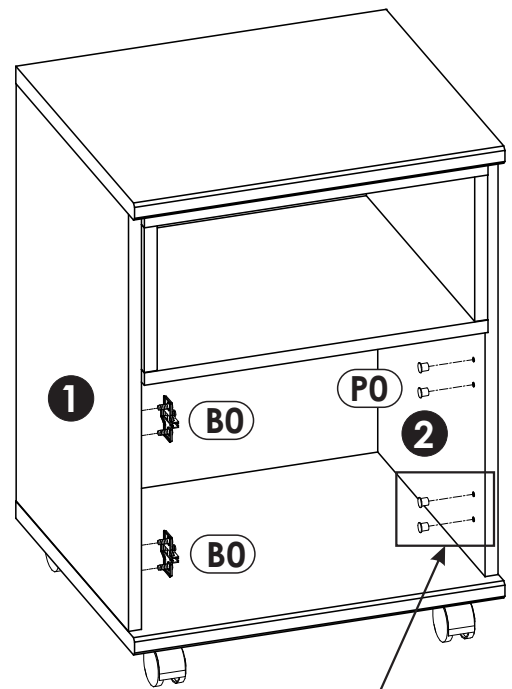
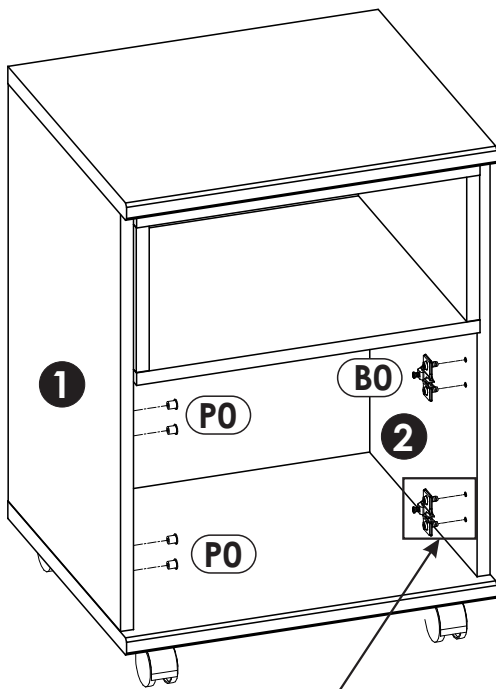
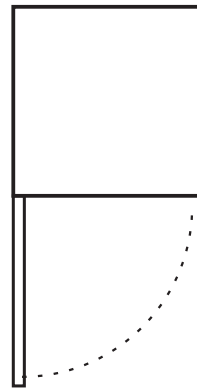
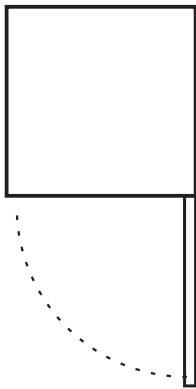

# 10 ▶

