

FLECK 9100 TWIN TANK WATER SOFTENER

› INSTALLATION GUIDE

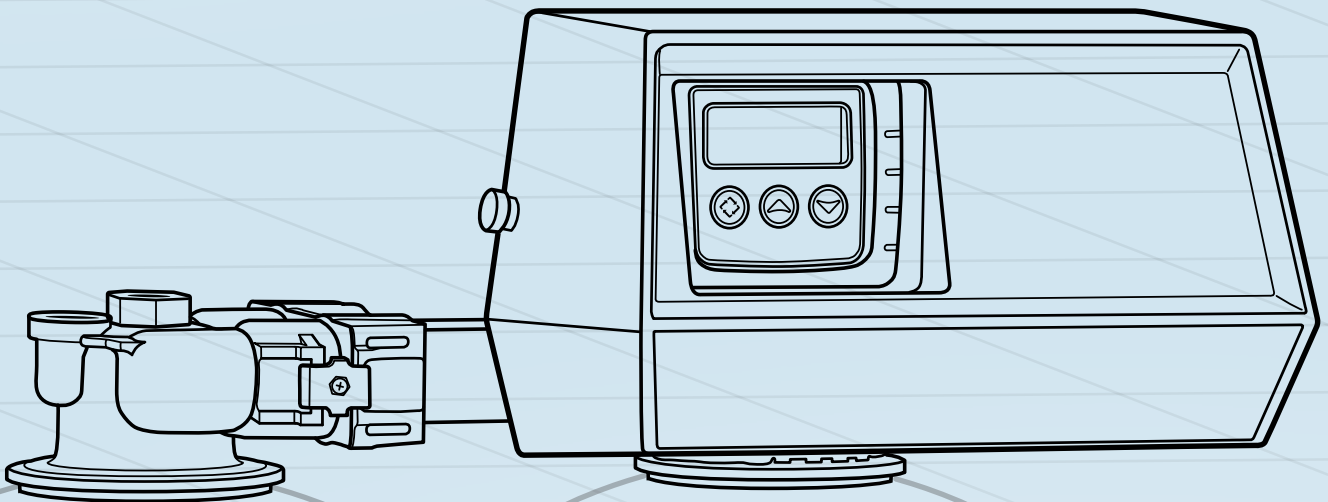

› PREFACE

Thank you for your purchase of a new water softener with Fleck 9100 Meter Control Valve from QualityWaterForLess.com! We have put together these instructions as reference and to be used as general installation guidelines. **It is always recommended that a licensed plumber perform all installation work according to all local codes.** We at QualityWaterForLess.com cannot assume responsibility for improper installation, application, or injury or damage as a result of improper installation.

›TABLE OF CONTENTS

Page 2	Preface (Click to Jump to Page)
Page 3	Table of Contents
Page 4	General Reference and Quick Electronic SXT Valve Programming
Page 5	Mechanical Valve Programming
Page 6	Calculating your Hardness Level and Salt Grid Table
Page 7	Tank Size, Salt Setting, and Salt Grid Table
Page 8	Pre-Installation and Home Plumbing Diagram
Page 9	Placing and Filling the Tank
Page 10	Installing the Fleck 9100 Valve onto the Tank
Page 12	Plumbing the Fleck 9100 Valve into your Home and the Brine Tank Connection
Page 14	Making the Drain Connection and Meter Connection
Page 15	Programming: Entering Master Programming Mode and Initial Programming
Page 16	Programming: Tank Number, Capacity, Hardness, and Reserve Settings
Page 17	Programming: Day Override, Regeneration Time, Backwash, Brine Draw, Rapid Rinse, and Brine Fill Duration
Page 18	Programming: Meter Type and Resetting the Time
Page 19	Initial System Start-Up and Testing for Leaks

›GENERAL REFERENCE

Please take a moment to review this page in order to familiarize yourself with these four ports on the valve. It is crucial not to mistake the inlet port with the outlet port. Mistaking and reversing the inlet and outlet ports will lead to failure of your softener system (Figure 4-A).

As you work through this guide, please make sure to follow all instructions exactly and to make special note of the bolded instructions and warning symbols. **PDF viewers may click underlined text to jump to that page or the page number in the bottom corner of every page to jump to the table of contents.** All our installation guides may be found on our site under "Information."

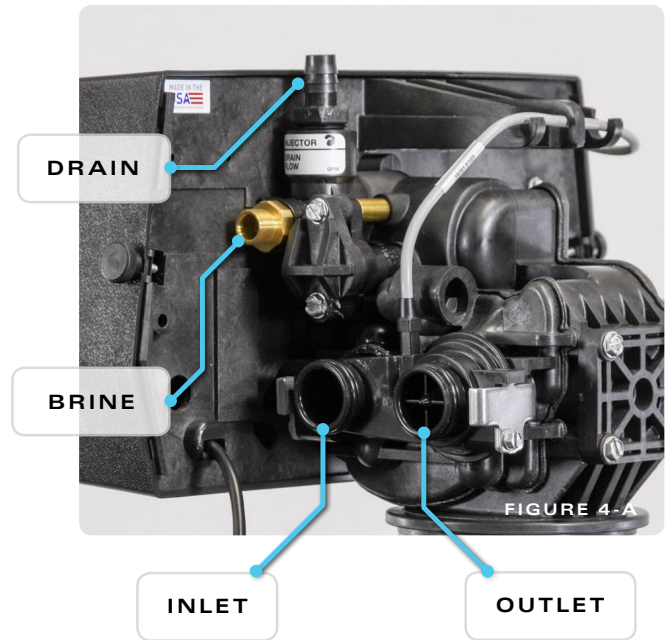



›QUICK START SXT ELECTRONIC PROGRAM

If you have a Fleck 9100 SXT electronic meter valve, here are your program settings. **If not all of the values are filled in, you can calculate the missing values from the exercise on pages 6 and 7 of this guide.** There we will cover identifying the 3 essential values of **H - HARDNESS**, **C - UNIT CAPACITY**, and **BF - BRINE FILL**. The remaining values that are already filled in are general standards for all softener sizes and hardness levels.

MASTER PROGRAMMING MODE: To enter in/check the adjacent values of your system, follow these steps: With either the up or down arrow button, change the clock to 12:01 PM, set the time by clicking the left-most, CYCLE / REGEN button, and then hold both the up and down arrow buttons for 5 seconds to enter master programming mode. Change values with the arrow buttons and set each value and advance to the next setting by clicking the CYCLE / REGEN button.

A more in-depth guide to programming the Fleck 9100 SXT is provided beginning on **page 15**.

FM - Flow Meter Type	
 t0.7	 P0.7

SETTING	INPUT VALUE
DF - Display Format	GAL - Gallons
VT - Valve Type	dF1b
CT - Control Type	FI - Flow Immediate
NT - Number of Tanks	2 Tanks
TS - Tank in Service	U X (Leave the Same)
C - UNIT CAPACITY	___ ,000 Grains
H - HARDNESS	___ Grains per Gallon
RS - Reserve Selection	SF
SF - Safety Factor	10%
DO - Day Override	14 Days
RT - Regen Time	2:00 AM
BW - Backwash	10 Minutes
BD - Brine Draw	60 Minutes
RR - Rapid Rinse	12 Minutes
BF - BRINE FILL	___ Minutes
FM - Flow Meter Type	t0.7 or P0.7

Job Number: _____

Model Number: _____

Mineral Tank Size: _____

MECHANICAL PROGRAM

If you have a mechanical meter valve, here are your softener program settings. **If you have an SXT valve, refer to page 4 for your programming values.** If not all of the values to the right are filled in, you can **calculate the missing values below AND with the exercise on pages 6 and 7 of this guide.** The remaining values that are already filled in are general standards for all softener sizes and hardness levels.

SETTING	INPUT VALUE
GC - GAL CAPACITY	___ 00 Gallons
BW - Backwash	10 Minutes, 5 Pins
BD - Brine Draw	60 Minutes, 30 Slots
RR - Rapid Rinse	12 Minutes, 6 Pins
BF - BRINE FILL	___ Minutes, ___ Slots

The **GC - GALLON CAPACITY** equates to the **C - UNIT CAPACITY** divided by the **H - HARDNESS** minus 10% of the result (Ex: 64K tank / 28 gpg hardness = 2,286 gal; 2,286 gal - 229 = 2,057 gal capacity. **Unit Capacity and Hardness can be determined from pages 6 and 7**). If the result exceeds the highest number on the dial, use the next smallest **Unit Capacity** listed on **the table on page 7**. With the front cover off of your control valve and while looking at the panel on the left side, pull out and rotate the dial and line up your gallon capacity with the white dot (Figure 5-A).

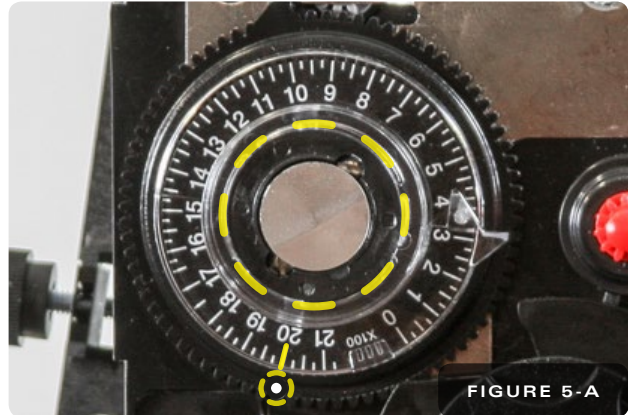

Swing open the left panel with the capacity wheel to the left to reveal the Program Wheel on the opposite side of the panel (Figure 5-B). To set the regeneration cycle times with the above input values, place the pins in the slots surrounding the wheel. **Each slot/pin on the Program Wheel represents 2 minutes during the regeneration process.**

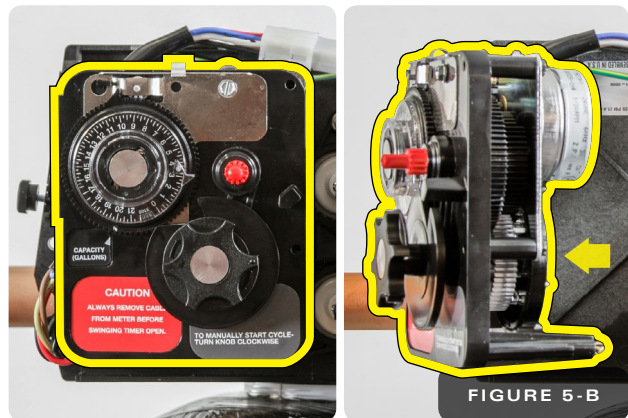

1. The first **group** of pins represents the BW - Backwash duration; 5 pins for 10 minutes (Figure 5-C).
2. The next **span of empty slots** represents the BD - Brine Draw duration; 30 empty slots for 60 minutes.
3. The next **group** of pins represents the RR - Rapid Rinse duration; 6 pins for 12 minutes.
4. The next **span** of empty slots represents the **BF - BRINE FILL** duration **found on page 7**. If it calls for an odd number of minutes, round up for the appropriate number of pins (Ex: 15 min → 16 min → 8 pins).
5. The last **group** of 2 pins marks the end of regeneration.

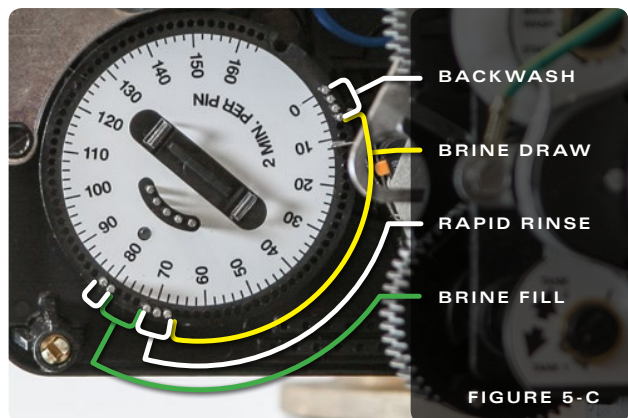

1 › CALCULATING HARDNESS, CAPACITY, AND BRINE FILL









- 1) **Water Test:** Before start-up, it is crucial that you know your water's **HARDNESS** and **IRON** levels in order to set up your unit properly. If your unit is not programmed with your particular hardness level, it will either regenerate too early or too late. If you do not know your water hardness or iron levels, you can take a sample of your untreated water to a local pool shop, hardware store, or well driller (**city water has no iron**)
- 2) **Initial Hardness:** Your Hardness test results may be recorded in Grains per Gallon (gpg), Parts per Million (PPM), or Milligrams per Liter (mg/L). Note that **PPM and mg/L are the same measure** and both figures can be used interchangeably. **If you get a hardness level in PPM or mg/L, please divide this number by 17.1 to get Grains (gpg).** Ex: If your hardness is measured at 300 PPM, take $300 / 17.1 = 18$ gpg before iron

$$\underline{\hspace{2cm}} \text{ PPM Hardness} \div 17.1 = \underline{\hspace{2cm}} \text{ gpg Hardness before Iron}$$

- 3) **H - COMPENSATED HARDNESS:** Your Iron results should also be measured in either PPM or mg/L. **Take your level of iron multiplied by 5 and add it to the hardness level from the previous step.** This final figure will be your **Compensated Hardness Level** that we will program into your softener system. Ex: If your iron level is measured at 2 PPM, add $2 \times 5 = 10$ Grains of hardness to existing hardness total. $18 + 10 = 28$ Grains Total

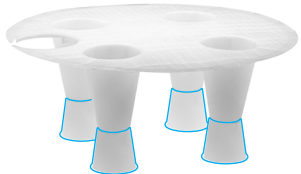
$$\underline{\hspace{2cm}} \text{ gpg Hardness} + (\underline{\hspace{2cm}} \text{ PPM Iron} \times 5) = \underline{\hspace{2cm}} \text{ gpg } \text{H - COMPENSATED HARDNESS}$$

- 4) **The compensated hardness level you just calculated will be the "H" value you use to program your softener. You may record this in the table on page 4 or 5.** Depending on your compensated hardness level, you will be able to use a different salt setting for programming and running your softener unit. The lower the hardness level, the more efficient you will be able to be with salt consumption for regeneration

	11X11" GRID	15X17" GRID	18" DIAMETER GRID
PLAIN GRID			
GRID + 3" LEGS			
GRID + 6" LEGS			

- 5) **C - UNIT CAPACITY:** In the first column, identify the **section** containing your softener tank size and then within this section, find the **row** pertaining to your **H - Compensated Hardness** level. Then look under the **C - Capacity** column to find the most efficient program value to enter for your **C - Unit Capacity** and record it **in the table on page 4 or 5**. **Note that your unit capacity program value may actually be lower than the tank's rated capacity.** This is to accommodate a lower salt dose for regeneration.
- 6) **BF - BRINE FILL:** In the first column, identify the **section** containing your softener tank size and then within this section, find the **row** pertaining to your **H - Compensated Hardness** level. Then look under the **BF - Brine Fill** column to find the most efficient program value to enter for your **BF - Brine Fill** and record it **in the table on page 4 or 5**.
- 7) **Example:** If you ordered a 64K grain capacity system and have 28 gpg compensated hardness, you would look under the 64K, 2.0 cu ft section and then look under the 25+ gpg row for your particular programming values. Note that the 11x11" and the 15x17" brine tanks are too small for the amount of brine needed to regenerate a 64K grain capacity system with 25+ gpg hardness. According to the table you would opt for an 18" diameter brine tank with a grid plus 6" legs

Tank Size	H HARDNESS	C CAPACITY	BF BRINE FILL	lbs of Salt	11x11" Grid	15x17" Grid	18x33" Grid	18x40" Grid	24x41" Grid	24x50" Grid
24K 0.75 cu ft 8x44"	0 - 12 gpg	15K	3 Min	4.5 lbs	Grid	NO GRID	NO GRID	NO GRID	TOO LARGE	TOO LARGE
	12 - 25 gpg	20K	5 Min	7.5 lbs	Grid	Grid	NO GRID	NO GRID		
	25+ gpg	24K	7 Min	11.25 lbs	Grid + 3" Legs	Grid	Grid	Grid		
32K 1.0 cu ft 9x48"	0 - 12 gpg	20K	4 Min	6 lbs	Grid	NO GRID	NO GRID	NO GRID	TOO LARGE	TOO LARGE
	12 - 25 gpg	27K	7 Min	10 lbs	Grid + 3" Legs	Grid	Grid	Grid		
	25+ gpg	32K	10 Min	15 lbs	Grid + 6" Legs	Grid + 3" Legs	Grid	Grid		
40K 1.25 cu ft 10x44"	0 - 12 gpg	25K	5 Min	7.5 lbs	Grid	Grid	NO GRID	NO GRID	TOO LARGE	TOO LARGE
	12 - 25 gpg	34K	9 Min	12.5 lbs	Grid + 3" Legs	Grid	Grid	Grid		
	25+ gpg	40K	13 Min	18.75 lbs	TOO SMALL	Grid + 3" Legs	Grid + 3" Legs	Grid + 3" Legs		
48K 1.5 cu ft 10x48"	0 - 12 gpg	30K	7 Min	9 lbs	Grid + 3" Legs	Grid	Grid	Grid	TOO LARGE	TOO LARGE
	12 - 25 gpg	41K	10 Min	15 lbs	Grid + 6" Legs	Grid + 3" Legs	Grid	Grid		
	25+ gpg	48K	15 Min	22.5 lbs	TOO SMALL	Grid + 6" Legs	Grid + 3" Legs	Grid + 3" Legs		
64K 2.0 cu ft 12x52"	0 - 12 gpg	40K	8 Min	12 lbs	Grid + 3" Legs	Grid	Grid	Grid	Grid + 5" Legs	Grid + 5" Legs
	12 - 25 gpg	54K	14 Min	20 lbs	TOO SMALL	Grid + 6" Legs	Grid + 3" Legs	Grid + 3" Legs		
	25+ gpg	64K	20 Min	30 lbs	TOO SMALL	TOO SMALL	Grid + 6" Legs	Grid + 6" Legs		
80K 2.5 cu ft 13x54"	0 - 12 gpg	50K	10 Min	15 lbs	Grid + 6" Legs	Grid + 3" Legs	Grid	Grid	Grid + 5" Legs	Grid + 5" Legs
	12 - 25 gpg	68K	17 Min	25 lbs	TOO SMALL	Grid + 6" Legs	Grid + 3" Legs	Grid + 3" Legs		
	25+ gpg	80K	25 Min	37.5 lbs	TOO SMALL	TOO SMALL	TOO SMALL	Grid + 6" Legs		
96K 3.0 cu ft 14x65"	0 - 12 gpg	60K	12 Min	18 lbs	TOO SMALL	Grid + 3" Legs	Grid + 3" Legs	Grid + 3" Legs	Grid + 6" Legs	Grid + 6" Legs
	12 - 25 gpg	81K	20 Min	30 lbs	TOO SMALL	TOO SMALL	Grid + 6" Legs	Grid + 6" Legs		
	25+ gpg	96K	30 Min	45 lbs	TOO SMALL	TOO SMALL	TOO SMALL	TOO SMALL		
120K 4.0 cu ft 16x65"	0 - 12 gpg	80K	16 Min	24 lbs	TOO SMALL	Grid + 6" Legs	Grid + 3" Legs	Grid + 3" Legs	Grid + 8" Legs	Grid + 8" Legs
	12 - 25 gpg	108K	27 Min	40 lbs	TOO SMALL	TOO SMALL	TOO SMALL	TOO SMALL		
	25+ gpg	120K	40 Min	60 lbs	TOO SMALL	TOO SMALL	TOO SMALL	TOO SMALL		

⚠️ PRE-INSTALLATION

Before assembly of your new system, be sure that the following conditions have been met for the placement of your system:

- Level, firm surface, such as concrete, on which to place the softener tanks and salt tank (also known as a **brine** tank)
- Un-switched power source, standard US plug, 120v 60hz (the softener system includes a 5 ft power cord and plug)
- Access to the water main coming into your home. You will need to install the softener at this point to assure that water for the home is going through the system
- Nearby floor drain or standpipe to connect to the softener for use during each regeneration

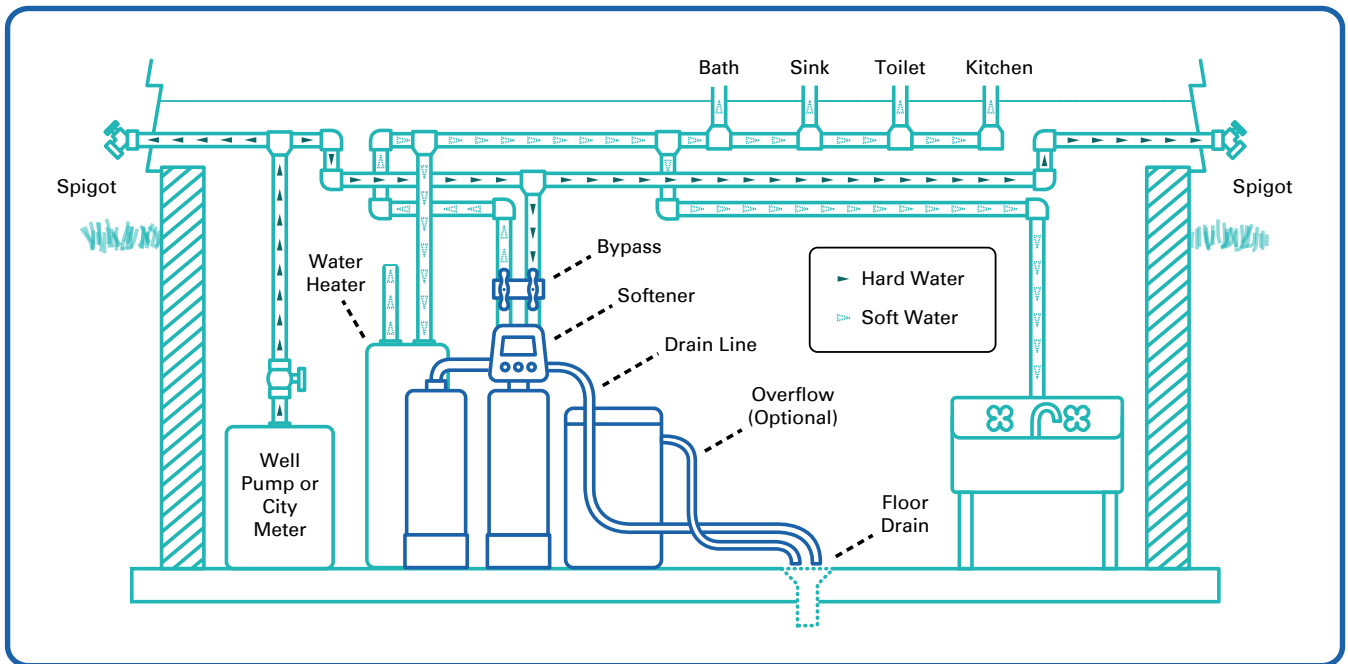

2 › PLACING AND FILLING THE TANK

- 1) Choose the final location for your water softener and place the tanks upright and level on the surface. Filling the tanks may be necessary on some larger system sizes. Your tanks may have also come pre-filled, and in this case you only need to unscrew the protective cap as shown in **Figure 9-A**
- 2) **If your tanks are not filled**, place the riser tubes into the tanks as shown in **Figure 9-B**. Please make sure that the riser tubes seat into the bottoms of the tanks and that the tops of the tubes are flush with the tops of the tank openings



FIGURE 9-A



FIGURE 9-B

- 3) Before filling the tanks, place a piece of painter's tape over the top of the riser tubes to prevent resin from dropping down inside the riser tubes as shown in **Figure 9-C**. **⚠ Avoid using duct tape which leaves behind unwanted residue**
- 4) Place the included filling funnel over the top of the tank as shown in **Figure 9-D** and prepare to fill the tank. If your softener system came with **gravel**, please pour this into the tank **first**, then pour in the included resin media afterwards. Do this for both tanks



FIGURE 9-C



FIGURE 9-D

3 › INSTALLING THE FLECK 9100 VALVE

- 1) Remove the filling funnel and tape and while using the included silicone lubricant packet, lubricate the inner and outer o-rings on the bottom of the Fleck 9100 Meter Valve and the second tank adapter as shown in Figures 10-A and 10-B

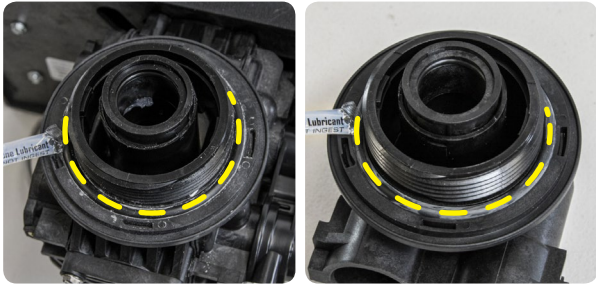

VALVE ADAPTER . FIGURE 10-A



VALVE ADAPTER . FIGURE 10-B

- 2) Install a **top screen/upper distributor (standard OR fine mesh)** to the bottom of the Fleck 9100 SXT Meter Valve and the second tank adapter (Figure 10-C). Then place the valve onto the top of the tank with the riser tube fitting into the central o-ring on the valve (Figure 10-D). **Hand-tighten** the valve to the tank. **Do not use Teflon tape or pipe dope on the valve or tank threading**



FIGURE 10-C



FIGURE 10-D

- 3) Loosen the two valve case screws to uncover the front of the valve to prepare for the next step of removing the plumbing adapter clips (Figure 10-E)



FIGURE 10-E

- 4) Please review the diagram below to make sure you install the meter, bypass, and tube assembly on the correct side of the valve (Figure 10-F). **⚠ Please note that you absolutely must not attach these components on the wrong side of the valve**

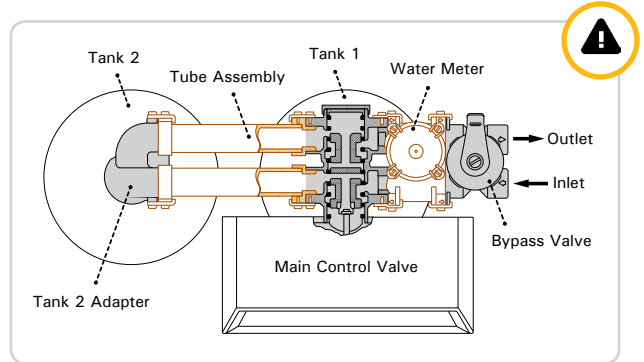

SYSTEM TOP VIEW . FIGURE 10-F

- 5) Loosen the screws holding the plumbing adaptor clips in place as shown in Figure 11-A and locate the plumbing adapter that came with your system

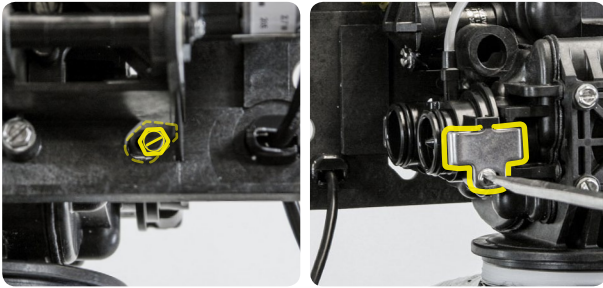

FRONT BACK . FIGURE 11-A

- 6) Using the included silicone lubricant packet, lubricate the o-rings on the meter of the Fleck 9100 Meter Valve as shown in Figure 11-B

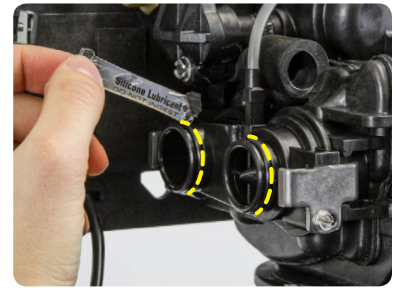

FIGURE 11-B

- 7) Attach the plumbing adaptor to the valve as shown in Figure 11-C (your bypass/plumbing adapter model may vary). When assembling the clips back onto the valve, leave the first clip loose, tighten the second clip, and complete the assembly by going back and tightening the first clip. **⚠ Please lightly tighten the screws into the meter as overtightening will easily cause cracking**

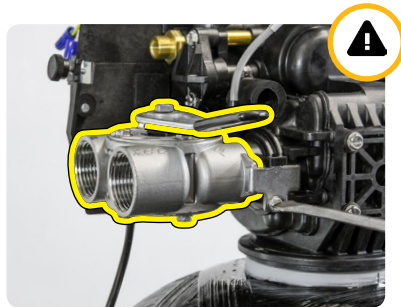

FIGURE 11-C

- 8) Locate the included plastic tube assembly and lubricate all four o-rings as shown in Figure 11-D



FIGURE 11-D

- 9) First, attach the plastic tube assembly to the second tank adapter as shown in Figure 11-E

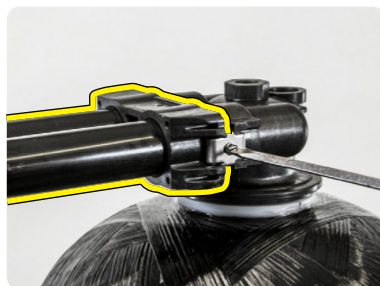
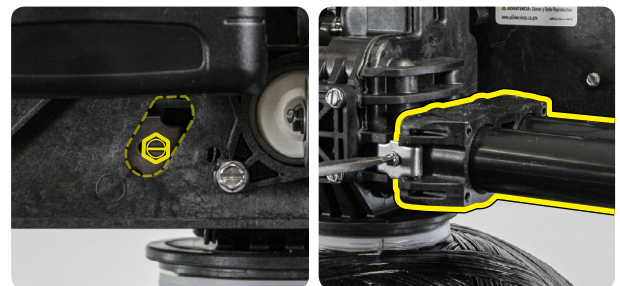

FIGURE 11-E

- 10) Then attach the plastic tube assembly onto the Fleck 9100 SXT Meter Valve as shown in Figure 11-F



FRONT BACK . FIGURE 11-F

4 › PLUMBING YOUR FLECK 9100 VALVE

- 1) Before beginning your installation, please first familiarize yourself with the IN and OUT ports on the Fleck 9100 Meter Valve. **In order to prevent damage to your home and to the softener system, install the softener according to the IN and OUT arrows on the softener valve**
- 2) Locate the main shut-off valve for your house and turn it to the OFF position. If you have a private well, this valve should be near your well pressure tank. If you have a city water supply, your valve should be near your water meter
- 3) Depressurize and drain your home of water by turning on all faucets and fixtures in your home, including those outside
- 4) Pick your installation point and cut a section of pipe out to run to and from your softener. **In most cases it is preferred to keep outside lines UNSOFTENED. If you wish to keep your outside lines unsoftened, you must plumb BYPASS lines to run hard water to these fixtures**
- 5) Using soldered copper, PVC plastic pipe, or flexible connections, plumb the system according to all local plumbing codes. **If using copper pipe, please pre-fabricate at least a 12" section of pipe for the IN and OUT bound lines and use a wet rag on the lines being soldered to prevent heat damage during soldering**
- 6) Once all connections have been made, place the system into bypass by either using your existing 3-valve bypass (if ordered with a YOKE adaptor), or by switching your included bypass ON (if ordered with a bypass)
- 7) Next, gradually open your main valve and allow all air in your plumbing lines to escape slowly. Also, you may turn off all outside and inside faucets and fixtures
- 8) Check for leaks at your plumbing site for signs of slow drips and rectify if necessary. **Please do NOT take the softener out of BYPASS as the installation is not completed yet. Please take this opportunity to check and re-check the IN and OUT ports to make sure they are correct**

5 › MAKING THE BRINE TANK CONNECTION

- 1) Attach the brine nut, tapered ferrule, metal tube insert, and brine line screen to one end of the included brine tubing as shown in Figure 12-A. **⚠ Be sure to face the tapered side of the ferrule towards the end of the brine line**
- 2) Next, connect this prepared end of the tubing to the Fleck 9100 Meter Valve as shown in Figure 12-B. Tighten the nut to the valve using a wrench until snugly in place. Be careful not to over tighten as you may sever the brine line

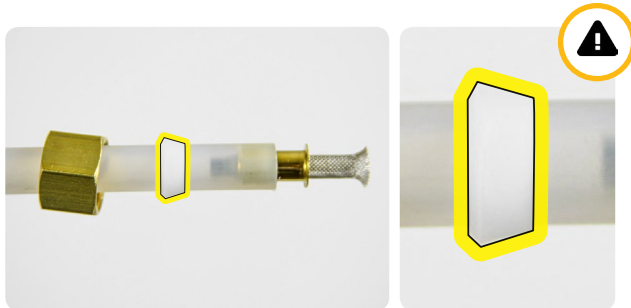

FIGURE 12-A



FIGURE 12-B

- 3) Locate the brine well and remove the cap. **You may also take this moment to prepare and insert the brine support grid determined from pages 6 and 7.** Then pull the **474 Brine Float Assembly** out of the brine well as shown in Figure 13-A



FIGURE 13-A

- 4) Next, fix the 474 Brine Float Assembly to the brine well through the pre-drilled hole and hand-tighten as shown in Figure 13-B

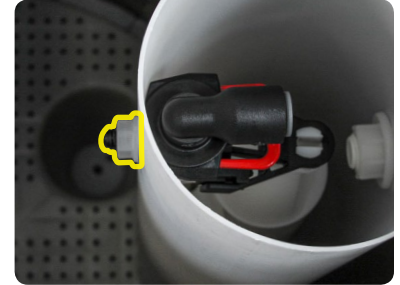

FIGURE 13-B

- 5) Take the other end of your brine line tube, make sure this end is clean cut, recut if it is not clean, mark 3/4" from the end of the tube, and insert the tube through the small hole drilled through the brine tank and brine well (Figure 13-C)



FIGURE 13-C

- 6) Firmly insert the tubing end 3/4" into the tube opening on the 474 Brine Float Assembly as shown in Figure 13-D. **⚠ Make sure the tube is fully inserted into the assembly**

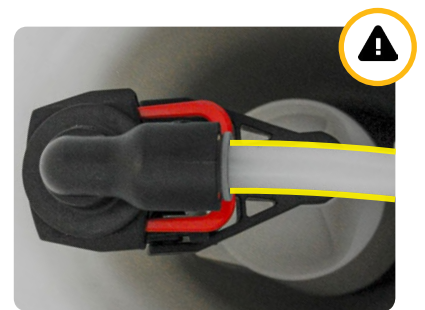

FIGURE 13-D

- 7) If you ever need to remove the tube, evenly press on both sides of the grey ring surrounding the tube and pull out as shown in Figure 13-E. **⚠ Be sure to recut the end of the tube each time you remove it to ensure a proper seal when the tube is inserted**

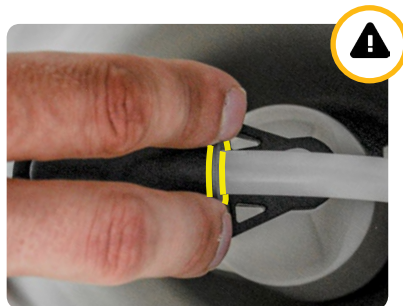

FIGURE 13-E

- 8) Finally, use 1/2" inner diameter (I.D.) tubing to connect the drain barb fitting on the brine tank to a floor drain as shown in Figure 13-F. Note that this is not necessary as the 474 assembly is designed to prevent an overflow from occurring, but it is a good precaution

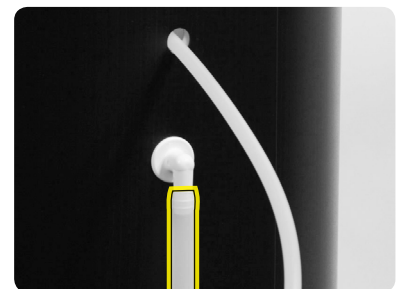

FIGURE 13-F

6 › DRAIN CONNECTION

- 1) Locate the drain barb fitting and use Teflon tape to wrap the threading as shown in Figure 14-A. **Be sure to wrap the tape clockwise with the threading towards you**
- 2) Install the drain barb fitting to the Fleck 9100 Meter Valve by screwing the fitting using a wrench snugly into the threads as shown in Figure 14-B. **⚠ Please use caution not to over tighten this fitting**



FIGURE 14-A



FIGURE 14-B

- 3) Next, connect your ½" I.D. drain line to the drain barb. Be sure to use rigid wall ½" I.D. tubing that will not flatten. Wrap electrical tape over the drain tubing to prevent a tubing split, and clamp the tubing securely into place with the included clamp as shown in Figure 14-C
- 4) Connect the other end of this drain line tubing securely to a standpipe or drain in accordance with all local plumbing codes. **Be sure that the drain line is securely in place before the use of the water softener system. When the system regenerates, there will be increased flow via this tubing which may cause the tubing to become loose**



FIGURE 14-C

7 › METER CONNECTION

- 1) Locate the meter cable on the rear of the control valve just in front of the drain port and plug it into the meter as seen in Figure 14-D (Your meter cable and meter model may vary. The model in Figure 14-D is the SXT turbine version). **⚠ If you fail to connect the meter cable to the meter on your meter demand softener, your system will not regenerate on time**

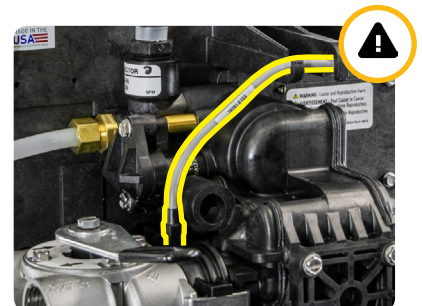

FIGURE 14-D

7 › PROGRAMMING THE FLECK 9100 SXT VALVE

- 1) To begin programming, first plug in your 9100 Valve to a nearby wall outlet. The system will illuminate 4 digits. The system will show the time of day and the amount of gallons remaining before the next regeneration. This display will switch between these values about every 10 seconds
- 2) Set the time on the system to 12:01 PM by pressing either the UP or DOWN button as shown in Figure 15-A. **⚠ Be careful to confirm the presence of the PM symbol in the top right corner.** You may hold the button to allow the time to scroll faster. Once the time display is set to 12:01 PM, press the REGEN button once as shown in Figure 15-B



FIGURE 15-A



FIGURE 15-B

- 3) To enter MASTER PROGRAMMING MODE, press the UP and DOWN buttons TOGETHER and HOLD both for 5 seconds as shown in Figure 15-C
- 4) The display should now show **DF / GAL** as shown in Figure 15-D. This indicates U.S. Operational Mode measuring consumption in gallons. Do not change this value and press the REGEN button once to advance to the next setting



FIGURE 15-C



FIGURE 15-D

- 5) The display should now show **VT / dF1b** as shown in Figure 15-E. This indicates Regeneration Flow Downflow Single Backwash. Do not change this value and press the REGEN button to advance to the next setting
- 6) The display should now show **CT / FI** as shown in Figure 15-F. This indicates Control Type Meter Immediate Mode. Do not change this value and press the REGEN button to advance to the next setting



FIGURE 15-E



FIGURE 15-F

- 7) The display should now show **NT / 2**. As shown in Figure 16-A. This indicates Number of Tanks is Dual. Do not change this value and press the REGEN button once to advance



FIGURE 16-A

- 8) The display should now show **TS / U1 or U2** as shown in Figure 16-B. This indicates which tank is currently in service. Leave this value the same and advance with the REGEN button



FIGURE 16-B

- 9) The display should now show **C / 32.0**. This indicates the Capacity is 32,000 grains. ⚠ **Use the UP or DOWN button to change this value to the one listed on page 4/calculated on pages 6 and 7** and press the REGEN button as shown in Figure 16-C



FIGURE 16-C

- 10) The display should now show **H / 20**. This indicates the Hardness is 20 gpg. ⚠ **Use the UP or DOWN button to change this value to the total hardness level of your water listed on page 4/calculated on pages 6 and 7** and press the REGEN button as shown in Figure 16-D



FIGURE 16-D

- 11) The display should now show **RS / SF** as shown in Figure 16-E. This indicates that the Reserve Selection is Safety Factor percentage. Do not change this value and press the REGEN button to advance to the next setting



FIGURE 16-E

- 12) The display should now show **SF / 10**. This indicates the Safety Factor is 10%. This means the system will leave 10% of the softening capacity for the day before regeneration. Leave this value the same and press the REGEN button as shown in Figure 16-F



FIGURE 16-F

- 13) The display should now show **DO / 14** as shown in Figure 17-A. This indicates the Day Override is 14 days; the system will regenerate in 14 days if the meter has not measured water consumption to have reached the calculated capacity. Do not change this value and press the REGEN button



FIGURE 17-A

- 14) The display should now show **RT / 2:00** as shown in Figure 17-B. This indicates the system will regenerate at 2:00 AM following the day override period. If you prefer an alternate regeneration time, please enter it here and then press the REGEN button to advance



FIGURE 17-B

- 15) The display should now show **BW / 10** as shown in Figure 17-C. This indicates Backwash time is 10 minutes long. Do not change this value and press the REGEN button to advance to the next setting



FIGURE 17-C

- 16) The display should show **BD / 60** as shown in Figure 17-D. This indicates Brine Draw time is 60 minutes long. Do not change this value and press the REGEN button to advance to the next setting



FIGURE 17-D

- 17) The display may now show **RR / 12** as shown in Figure 17-E. This indicates Rapid Rinse time is 12 minutes long. Do not change this value and press the REGEN button to advance to the next setting



FIGURE 17-E

- 18) The display may now show **BF / 10**. This indicates the length of the Brine Fill cycle during regeneration is 10 minutes. **⚠ Use the value listed on page 4/calculated on pages 6 and 7** and then use the UP or DOWN button to adjust this. Then press REGEN as shown in Figure 17-F



FIGURE 17-F

19) The display may now show **FM / t0.7** as shown in Figure 18-A. This indicates Flow Meter type 3/4" Turbine. Set the setting to t0.7 if you have the 3/4" turbine meter or P0.7 for the 3/4" paddle wheel meter. Press the REGEN button to advance to the home screen



FIGURE 18-A

20) The system will now exit Master Programming mode and the display should now show the time of day followed by the number of gallons remaining as shown in Figure 18-B. Change the time of day to your current time with either the UP or DOWN button and confirm the time with the REGEN button



FIGURE 18-B



FIGURE 18-C

21) Remember to replace the valve cover when you are finished installing your system as shown in Figure 18-C

8 › INITIAL START-UP

- 1) With one nearby softened faucet running in the COLD position, slowly open your bypass valve or 3-valve bypass to about ¼ open to allow the air trapped in the softener to escape via your running faucet. **NOTE: Opening the bypass too quickly or too open may damage your softener or plumbing**
 - 2) Allow the softener tank to slowly fill with water. After a few minutes, you will see a trickle of water coming from the cold water faucet. Allow the water to run slowly in this manner for an additional 5 minutes. Next, with the cold water faucet still running, gradually move your bypass valve to the fully open position. **NOTE: You may see some initial discoloration from the softened water – this is normal and should dissipate within the first 40-50 gallons of water used.** Turn off the running cold water faucet when the water runs clear
 - 3) Repeat steps 1 and 2 for the other tank (it will switch to the other tank automatically after a regeneration)
- 4) ⚠ **To test the integrity of your new system and all connections, it is strongly encouraged that you perform a short form regeneration to check for leaks before service.** Begin this process by adding approximately 5 gallons of water/the amount of water needed to cover the brine grid into the brine tank
 - 5) **If you have the mechanical version of the Fleck 9100**, begin a regeneration by turning the timer wheel clockwise, let the regeneration run its full course to completion, and check the entire system for leaks. If you notice a leak originating from the drain line/connection, **return to page 14** to review preparing the drain connection. If you notice a leak originating from the brine line/connections, **return to pages 12 and 13** to review preparing the brine tank connection
 - 6) **If you have the electronic Fleck 9100 SXT version**, begin the regeneration sequence by HOLDING the REGEN button for 5 seconds. Once the screen stops flashing BW, let BW - Backwash run for about 1 minute to observe the water leave out the drain line and check for leaks. If you notice any leaks, **return to page 14** to review preparing the drain connection. Click the REGEN button ONCE to move on to BD - Brine Draw
 - 7) Once the screen stops flashing BD, let BD - Brine Draw run for about 1 minute to observe the water level in the brine tank being drawn lower. Also check the brine line and the float valve in the brine well for leaks. If the water level doesn't lower or there is a leak, **return to pages 12 and 13** to review preparing the brine tank connection. Click the REGEN button ONCE to move on to RR - Rapid Rinse
 - 8) Once the screen stops flashing RR, advance from RR - Rapid Rinse to BF - Brine Fill by clicking the REGEN button ONCE more. Once the screen stops flashing BF, let BF - Brine Fill run for about 1 minute to observe the water level in the brine tank rise. Also check the brine line and float valve in the brine well for leaks. If the water level doesn't rise or there is a leak, **return to pages 12 and 13** to review preparing the brine tank connection. Click the REGEN button ONCE to finish
- 9) Now you may add 120-160 pounds of pellet, solar, or block salt to your brine tank. **Always keep your brine tank filled with salt to at least above the water level.** You do not need to perform a full regeneration immediately after installation as the new resin arrives at full softening capacity. Simply let your softener meter automatically trigger regenerations by tracking the water consumption

› CONGRATULATIONS

Your new softener with Fleck 9100 Meter Valve is now properly installed and programmed! Please maintain your system by keeping the softener plugged-in and always keep your brine tank filled with salt to at least above the water level. We appreciate your business and hope that you enjoy years of trouble-free softened water!