

PEBBLE

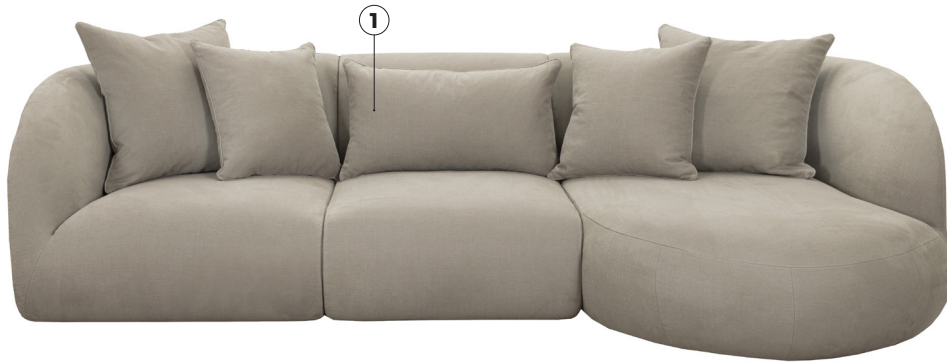

VILMERS

PEBBLE



Comfort

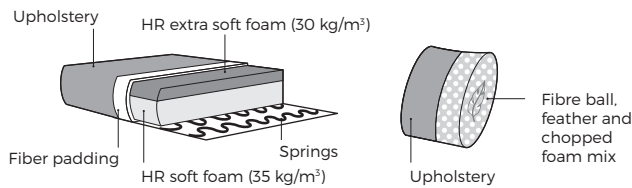

1. Upholstery



2. Legs



IMPORTANT:

Upholstered furniture is handmade using soft materials, therefore measurements can vary in all modules by up to **+/-2cm**.
 Modules and combinations shown in 2D drawings are left-sided. Modules and combinations can be mirrored from left to right.

Modules

Scale 1:100

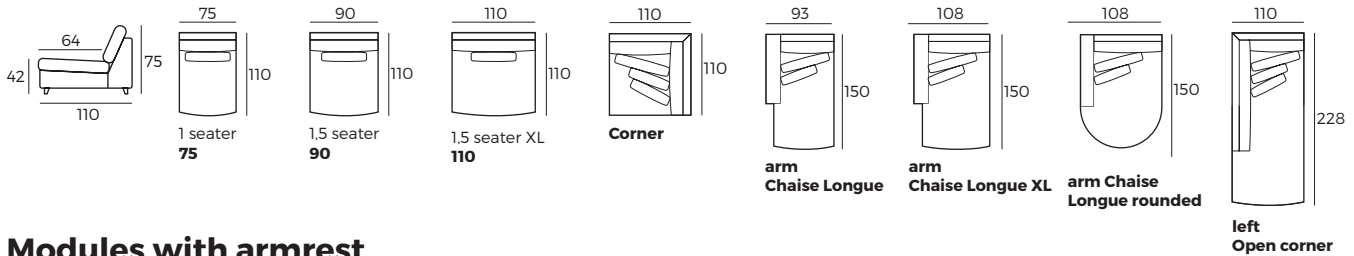

Modules with armrest

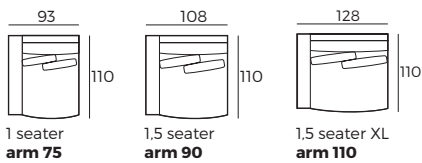

Combinations

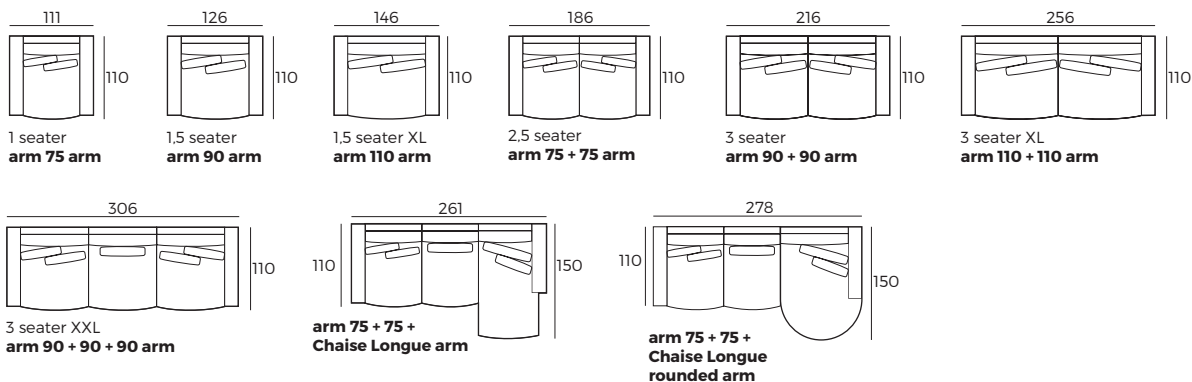

PEBBLE

Combinations

Scale 1:100

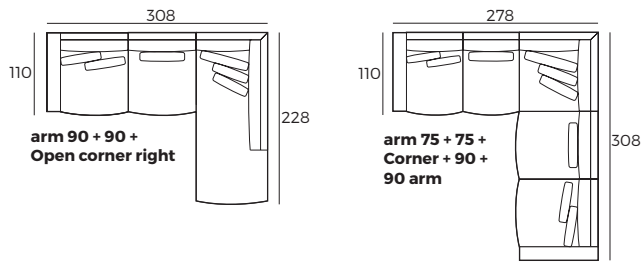

Accessories

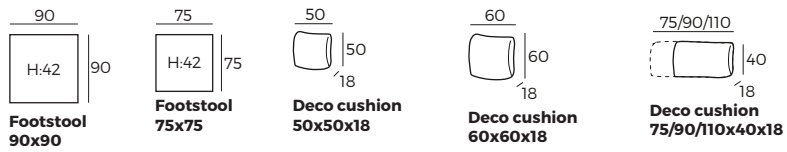

*The width of the cushion depends on the width of the seater.