



EPA Est 68177-CA-001

MAILING ADDRESS

PO Box 2189
Temecula, CA 92593

MAIN OFFICE

42371 Avenida Alvarado
Temecula, CA 92590
Toll Free: (800) 454-2725
Tel: (951) 296-3480
www.aquauv.com

DO NOT SUBMERGE THIS UNIT IN WATER!

**UV Sterilizer Instruction Manual Includes:
Classic Series
Twist Series
Swimming Pool & Spa Series**

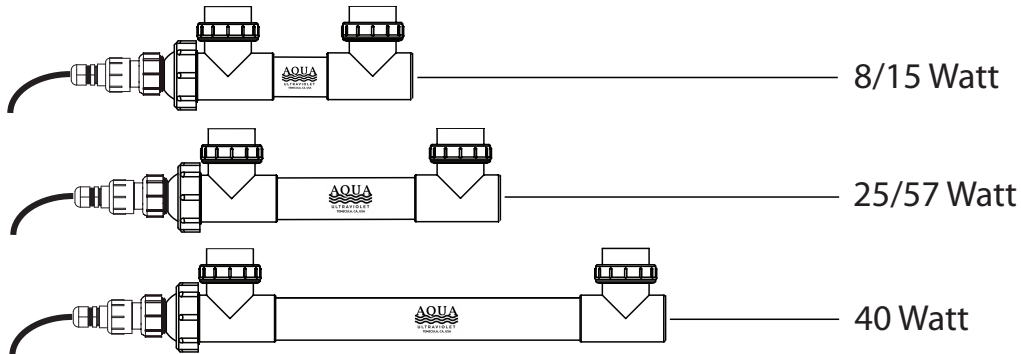

SEE PAGES 1 AND 2 FOR UNIT DIAGRAMS

Register your UV by using the warranty card included
or
go online to aquauv.com



Follow us on Facebook
www.facebook.com/aquauv



Follow us on Instagram
www.instagram.com/aquauv



See us on YouTube
www.youtube.com/AquaUltraviolet



TABLE OF CONTENTS

Classic & Swimming Pool / Twist Model Diagrams	1
Classic & Swimming Pool / Twist Wiper Model Diagrams	2
Important Information	3
Warranty Information	4
Introduction / How Ultraviolet Works	6
Fresh Water Sizing Chart	7
Salt Water Sizing Chart	8
Swimming Pool UV Sizing Chart	9
Recommended Layouts	10
Frequently Asked Questions	11
Installation Instructions	12
Trouble Shooting Leaks	15
Installing the Lamp for Single Lamp Units	16
Electrical Installation for Multiple Lamp Units	17
Winterizing	19
Maintenance Lamp Changes	20
Cleaning the Quartz Sleeve	21
Cleaning the Quartz Sleeve - Wiper Units	22
Replacing the Quartz Sleeve	23
Wiper Maintenance	24
Part List Classic & Twist	26
Part List Swimming Pool & Spa	28
Incorrect Installations	30

CLASSIC SERIES

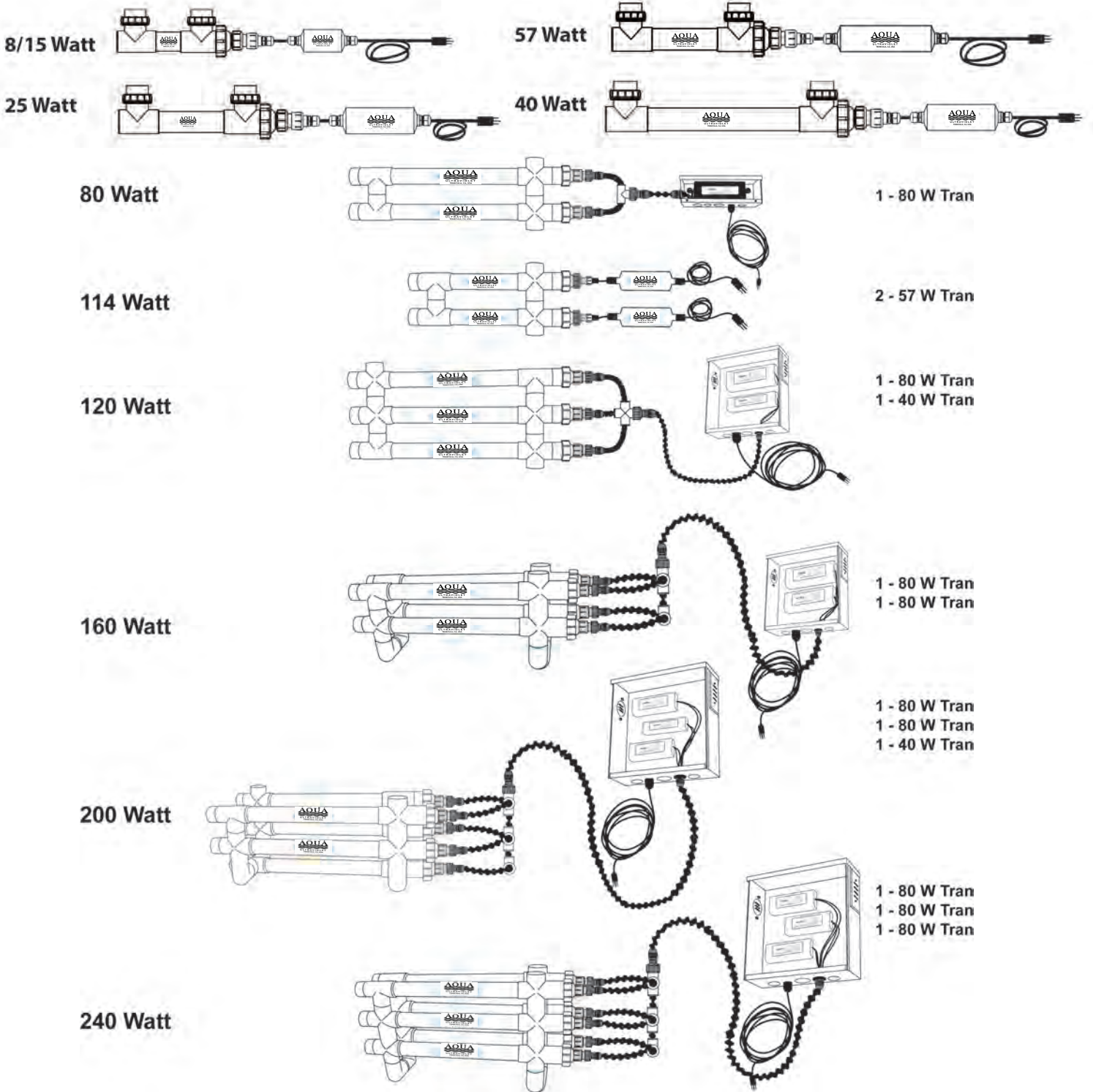

TWIST & SWIMMING POOL SERIES

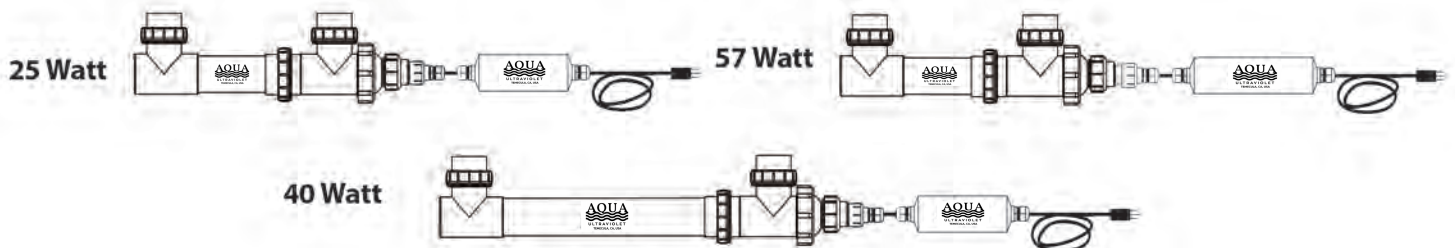

CLASSIC WIPER SERIES

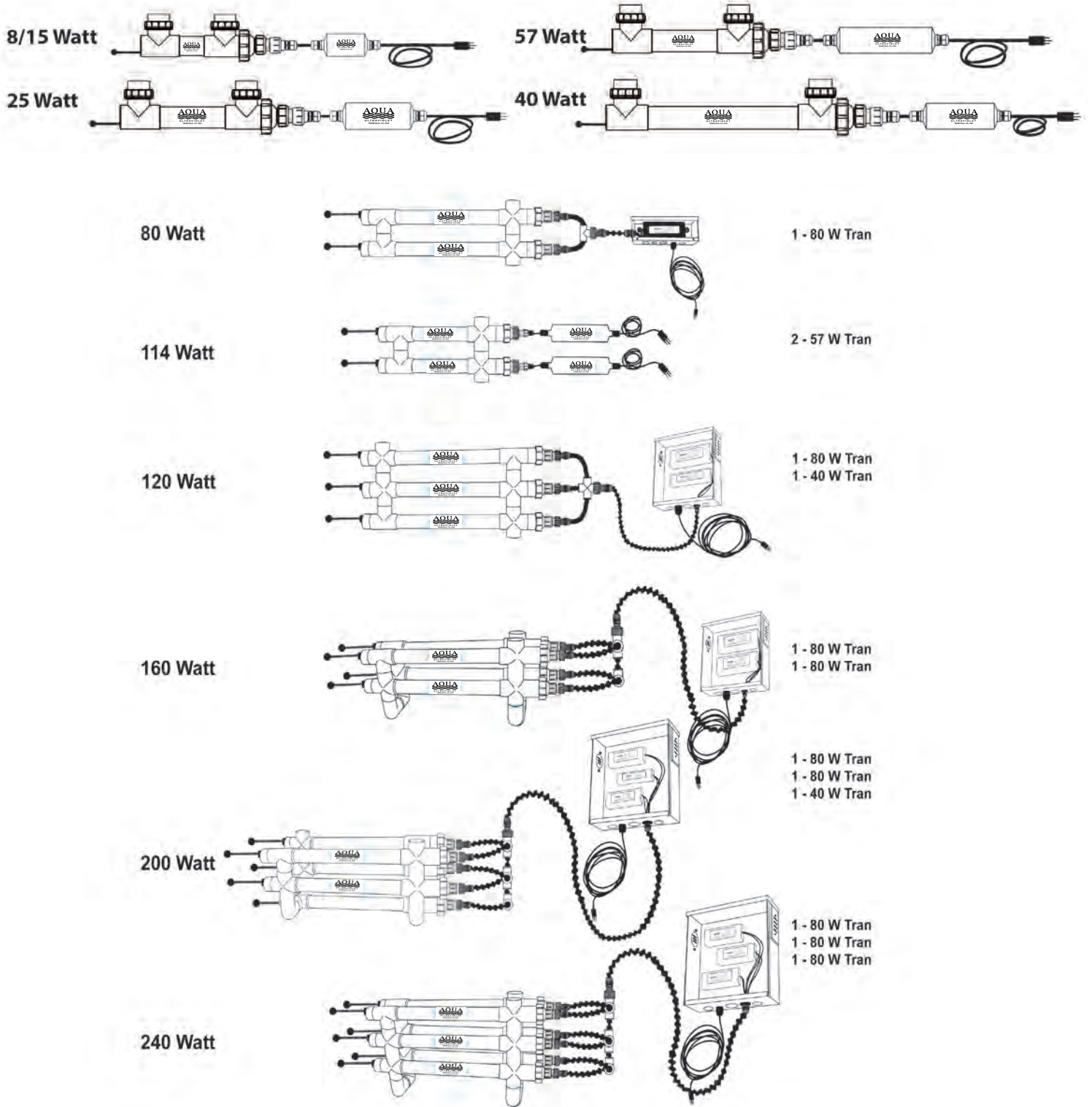

TWIST & SWIMMING POOL WIPER SERIES

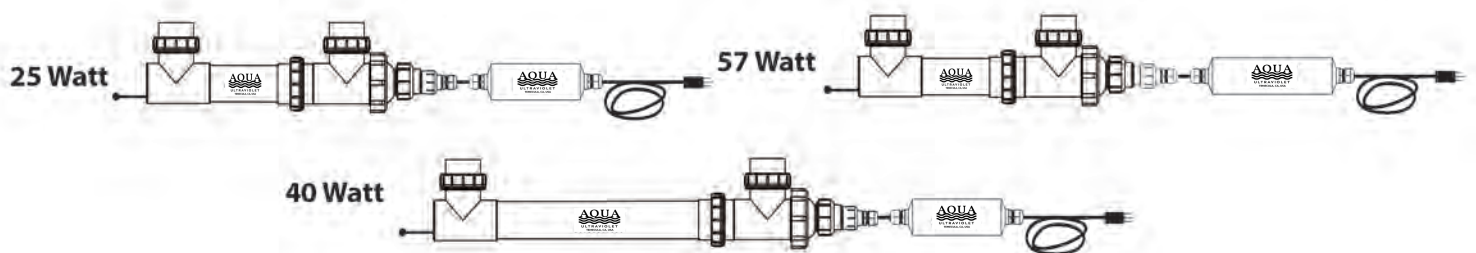

THANK YOU FOR PURCHASING THE BEST ULTRAVIOLET SYSTEM

IMPORTANT INFORMATION



WE CAN HELP YOU

Returning this product is expensive and time consuming for you, your retailer and for us, the manufacturer. Should you encounter any problems with your product, please call our toll free "HELP" line for assistance (800) 454-2725.

PLEASE DO NOT return your product to the store! Your dealer or distributor cannot offer any warranty work.



In the US please call
TOLL FREE (800) 454-2725
(951) 296-3480 Outside the U.S.
THANK YOU!

WARRANTY INFORMATION

Aqua Ultraviolet systems are warranted against failure due to defects in materials and/or workmanship during the warranty period. This warranty covers defects occurring under normal use and applies to the original retail purchaser and may not be transferred. The warranty and remedies set forth herein are conditional upon proper storage, installation, use, maintenance and conformance with the applicable use. It will be based upon Aqua Ultraviolet's discretion as to whether the defects are of manufacturing origin.

This warranty does not apply to appearance or accessory items. This warranty does not include damage due to shipping and handling, transportation, unpacking, set up, installation, improper maintenance, incorrect line voltage, modification, abuse, misuse, neglect, accident, fire, flood, acts of God or repair or replacement of parts supplied by anyone other than Aqua Ultraviolet.

Any oral statements about this product made by the seller, the manufacturer, their representatives or any other party does not constitute warranties and shall not be relied upon by the user and are not part of this contract.

Neither the seller nor the manufacturer shall be liable for any injury, loss or damages, direct, incidental or consequential including but not limited to lost profits, lost sales, injury, inability to use the product and the user agrees that no other remedy is available.

Before installing, the user shall determine the suitability of the product for their intended use and the user shall assume all risk liability whatsoever in connection therewith.

To validate this warranty, mail the enclosed warranty card within 10 days of purchase or register online at www.aquauv.com/support/productregistration

To have warranty work done the original receipt must be provided.

Warranty Period:

Housing: Limited lifetime warranty on housing against Ultraviolet degradation.

Complete Unit: One year from the date of purchase or 18 months from manufacturing date.

Limitations:

Warranty does not cover any malfunction from improper installation (we recommend that a licensed electrician install your system to the specifications outlined in this owners guide).

Warranty only applies to the original end user and is not transferable.

Warranty does not cover repairs done by anyone other than Aqua Ultraviolet.

Warranty is void if system is not plugged into a G.F.C.I. (Ground Fault Circuit Interrupter).

Warranty may not be modified by verbal statements by Aqua Ultraviolet, distributors, retailers, their agents or any other party.

Warranty covers the repair or prorated replacement of the Aqua Ultraviolet products.

Aqua Ultraviolet denies all liability for any other loss including but not limited to loss of equipment, income, livestock, pets, aquatic life or personal injuries.

Wiper system with Salt Water is not recommended and if utilized in this manner will void warranty on the Wiper parts.

There are no warranties on the Quartz Sleeve.

There are no warranties on broken Lamps. Lamps are prorated by usage.

Warranty is voided by the following:

Product labels defaced or removed.

Housing has been painted.

Product is improperly installed or maintained by user or agent.

Product abused, misused or damaged by user or their agent.

Product damage caused by electrical surges, electrical spikes, electrical brown outs or improper voltage.

Electrical cord has been cut.

Unit was run without water.

Use of anything other than genuine Aqua Ultraviolet Parts.

Damage from water to electrical components.

Any implied warranty granted under state law including warranties of merchantability or fitness for a particular purpose are limited to one year from the date of purchase or 18 months from the date of manufacture or as otherwise stated in the above warranty. Aqua Ultraviolet is not responsible for direct, indirect, incidental or consequential damages. Some states do not allow limitations on how long an implied warranty lasts and/or does not allow the exclusions or limitations of incidental damages so the above limitation and exclusion may not apply to you. This warranty gives you special legal rights and you may also have other rights that vary from state to state.

Warranty Returns or Repair Returns:

Please call Aqua Ultraviolet at (800) 454-2725 for a "Return Merchandise Authorization" (RMA) number, or email info@aquauv.com. You must have a valid RMA from an Aqua Ultraviolet customer service representative before sending any product in for warranty or repair. Please have your serial number, date of purchase and product type available when calling for an RMA number.

All warranty returns or repair returns must come freight prepaid with an RMA number clearly marked on the outside of the box. All other returns will be refused. Aqua Ultraviolet will not be liable for any shipping cost to return warranty or repair items. Include a note in the box with your RMA number, name, address, daytime phone number and brief description of the reason for return or repair.

Be sure to return product in the same packing or similar packing and insure the package (we recommend sending it UPS). If you do not have or can not locate proper packaging, please call our customer service department and we will send you packaging for a minimal charge.

Aqua Ultraviolet shall not be responsible for damage or loss done by the shipper. Nor shall Aqua Ultraviolet be responsible for merchandise that arrives damaged due to improper packaging. All claims for loss and damage must be filed by the customer with the shipper.

If the unit is found to be out of warranty we will contact you with the cost of repair. Your authorization is required prior to making any repairs.

INTRODUCTION



CAUTION: READ ALL INSTRUCTIONS CAREFULLY BEFORE BEGINNING INSTALLATION OR OPERATION.

We at Aqua Ultraviolet would like to take the time to thank you for purchasing the finest Ultraviolet System on the market.

For over thirty years, Aqua Ultraviolet has manufactured Ultraviolet Systems used in various industries, including aquaculture, public and commercial aquariums, educational institutions, government agencies and research organizations throughout the world.

Aqua Ultraviolet Sterilizers are used as a control to destroy single celled organisms, water borne bacteria, viruses, algae, fungi and protozoa. Aqua Ultraviolet sterilizers are recommended for both fresh and salt water systems as well as ponds, pools, spas, and drinking water. There are no residual effects when using an Aqua Ultraviolet Sterilizer. Ultraviolet will not affect Bio-filters or lower fish immune systems!

HOW ULTRAVIOLET WORKS

The Ultraviolet Lamp emits a germicidal ray which alters or disrupts the DNA or RNA of single celled organisms such as algae, bacteria and protozoa. By properly implementing an Aqua Ultraviolet System in-line, these organisms can be eradicated effectively without any harmful residuals.

Your Aqua Ultraviolet System was made to work as a control for green water and single celled organisms. This unit will not, nor will any other unit, completely sterilize your pond as the pond itself is not a sterile environment. As a control, this unit will effectively lower your water's bacterial count allowing your fish to stay healthier with less risk of disease.

The Aqua Ultraviolet Sterilizer works better on filtered water. Any debris in the water can inhibit UV Transmission.

The manual should answer most of the questions that you may have about the installation, operation and use of your new Aqua Ultraviolet Sterilizer. View our installation videos at www.aquauv.com. If you need technical support, we offer this service for free by telephone (800) 454-2725, or (951) 296-3480 M-F 8:30am - 3:30pm PST except selected holidays. You may reach us through the web www.aquauv.com or at info@aquauv.com.

FRESH WATER UV SIZING CHART

Classic UV Units	Size Fresh Water Sterilizer* in Gallons	30,000 $\mu\text{w}/\text{cm}^2$ (EOL) GPH	Fresh Water Pond Clarifier***	
			Gallons	Max Flow GPH
Classic 8 Watt	5 - 200	642	1,500	1,000
Classic 15 Watt	200 - 500	700	2,000	1,800
Classic 25 Watt	500 - 1,200	1,200	4,000	2,000
Classic 40 Watt	1,200 - 2,000	2,900	6,000	3,000
Classic 57 Watt	1,500 - 3,000	3,200	6,500	3,250
Classic 80 Watt	2,200 - 4,400	3,678	9,000	4,500
Classic 114 Watt	2,200 - 4,400	3,900	9,500	4,500
Classic 120 Watt	4,400 - 6,000	4,080	12,000	6,500
Classic 160 Watt	6,000 - 8,500	5,400	16,000	9,000
Classic 200 Watt	8,500 - 13,000	6,600	20,000	10,000
Classic 240 Watt	13,000 - 17,000	7,200	25,000	12,000
Twist Unit				
Twist 25 Watt	500 - 1,200	1,200	4,000	2,000
Twist 40 Watt	1,200 - 2,000	2,900	6,000	3,000
Twist 57 Watt	1,500 - 3,000	3,200	6,500	3,250

* Use the sterilizer column for crystal clear water and bacterial control, in pond and aquarium environments.

*** Use the clarifier column when the pond is partially in the shade and has 50% plant coverage. This will improve water clarity resulting in a natural looking pond.

GPH numbers are based on turning over the volume of water one time every hour to every hour and a half.

UV dosage is calculated at the end of lamp life (14 months).

Flow rates and results may vary

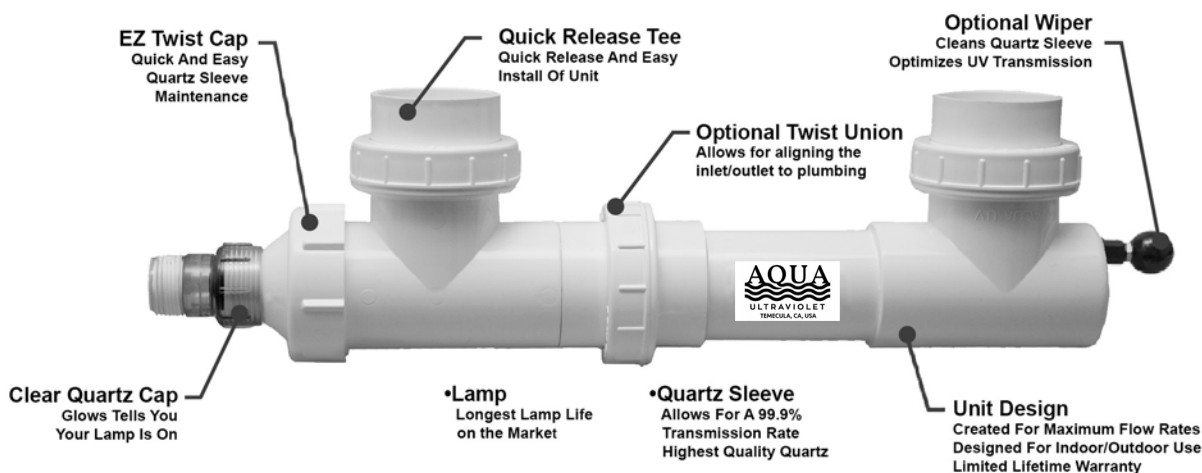

SALT WATER UV SIZING CHART

Classic UV Units	**Salt Water Tank Gallons	30,000 $\mu\text{w}/\text{cm}^2$ (EOL) GPH	45,000 $\mu\text{w}/\text{cm}^2$ (EOL) GPH	60,000 $\mu\text{w}/\text{cm}^2$ (EOL) GPH	75,000 $\mu\text{w}/\text{cm}^2$ (EOL) GPH	90,000 $\mu\text{w}/\text{cm}^2$ (EOL) GPH
Classic 8 Watt	70	642	428	321	256	214
Classic 15 Watt	75	700	466	350	280	233
Classic 25 Watt	150	1,200	800	600	480	400
Classic 40 Watt	325	2,900	1,930	1,450	1,160	967
Classic 57 Watt	355	3,200	2,133	1,600	1,280	1,066
Classic 80 Watt	600	3,678	2,452	1,839	1,471	1,226
Classic 114 Watt	700	3,900	2,600	1,950	1,560	1,300
Classic 120 Watt	900	4,080	2,720	2,040	1,632	1,360
Classic 160 Watt	1200	5,400	3,600	2,700	2,160	1,800
Classic 200 Watt	1500	6,600	4,400	3,300	2,640	2,200
Classic 240 Watt	1800	7,200	4,800	3,600	2,880	2,400
Twist Units						
Twist 25 Watt	150	1,200	800	600	480	400
Twist 40 Watt	325	2,900	1,930	1,450	1,160	967
Twist 57 Watt	355	3,200	2,133	1,600	1,280	1,066

Reef Tanks: A UV Rated in the 30,000 to 45,000 columns is ideal for the reef environment. UV's rated at higher kill rates will destroy the planktonic food supply for the reef.

Marine Fish Tanks (No reef or Live Rock): A UV rated in the 75,000 to 90,000 columns will be the most effective at controlling fish disease.

All UV dosages are calculated at the end of lamp life (14 months).

Flow rates and results may vary

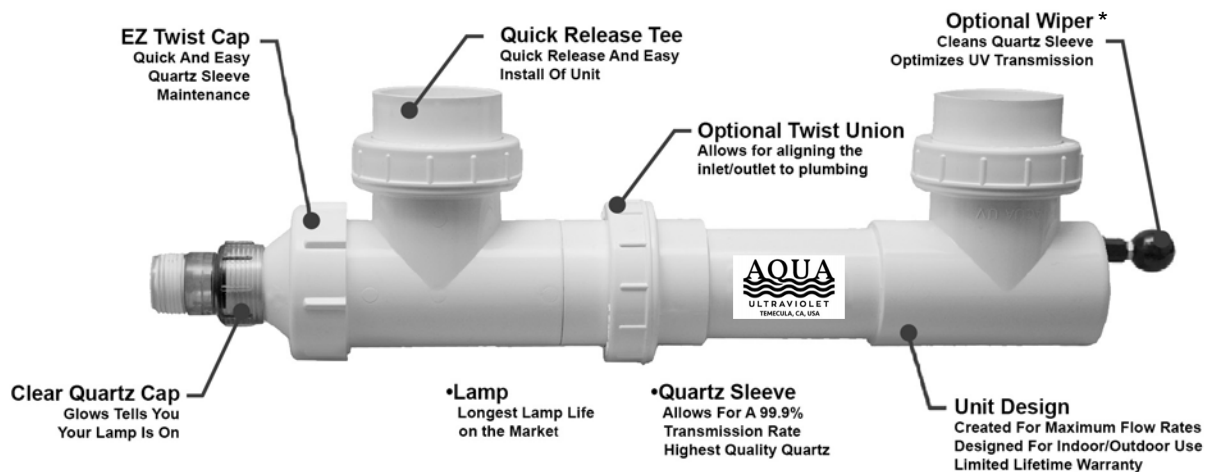

*Aqua Ultraviolet does not recommend utilizing Wipers with Salt Water and if utilized in this manner will void warranty on the Wiper parts.

SWIMMING POOL & SPA UV SIZING CHART

Model	Max Flow GPM	Pool Volumes in Gal.	Plastic Units w/ Twist 3" Body with 3" inlet/outlet 2" Reducers included	Dimension (in inches)
25 Watt	20 GPM	6,000	3"	27 x 3.5 x 5.5
40 Watt	48 GPM	15,000	3"	37.25 x 3.5 x 5.5

- Lowers chemical use and cost by 75%
- Kills bacteria and viruses
- Increases the life of pool equipment
- Eliminates chloramine and its odors without effecting pH
- Longest lamp life on the market
- Twist UV's allow for adjusting the inlet and outlet to the perfect position for each installation

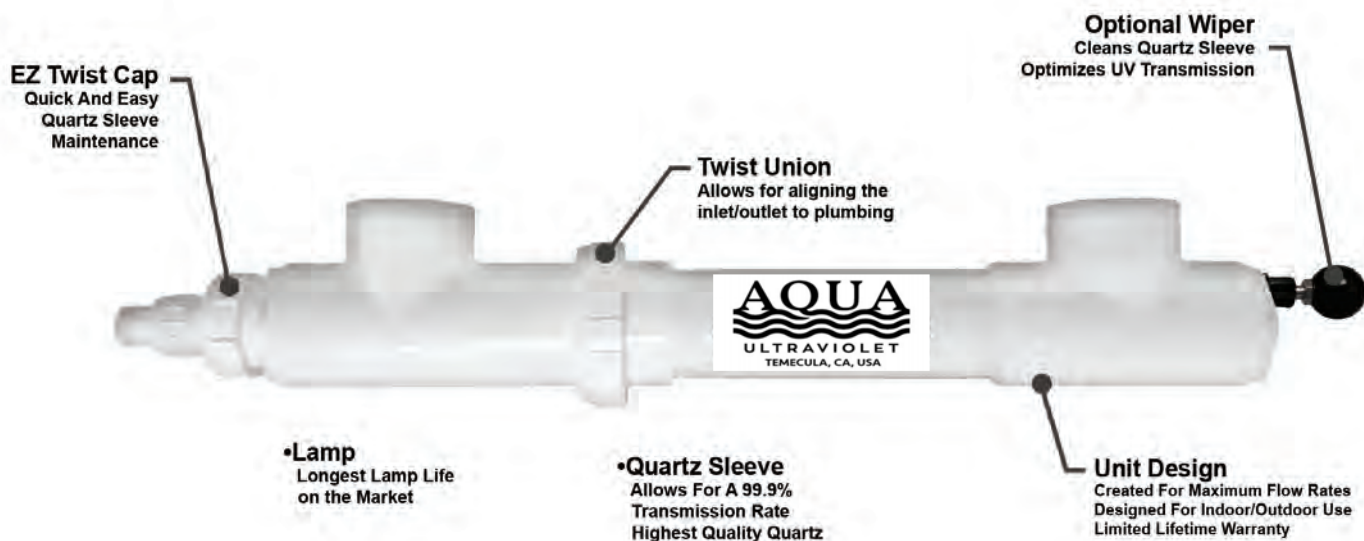

RECOMMENDED POOL & POND LAYOUTS

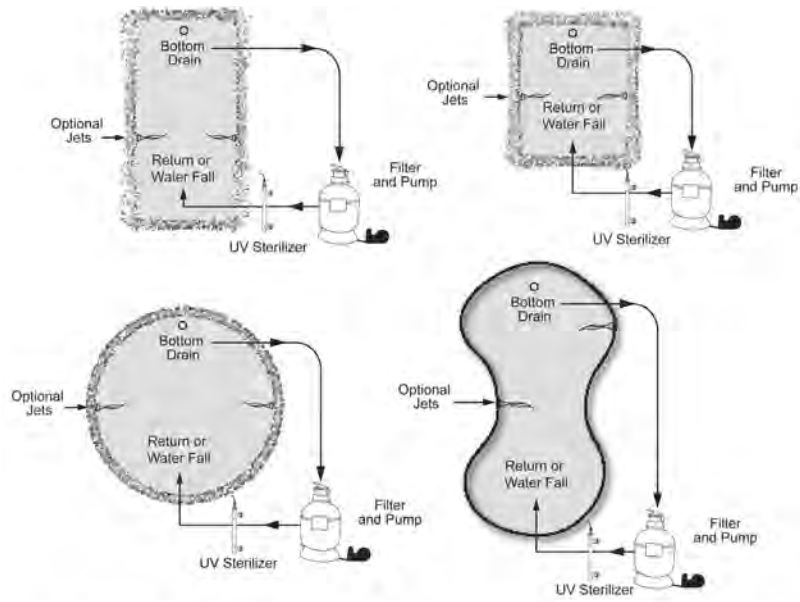

Incorrect Installation

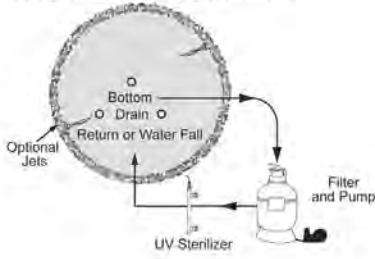

Incorrect Installation

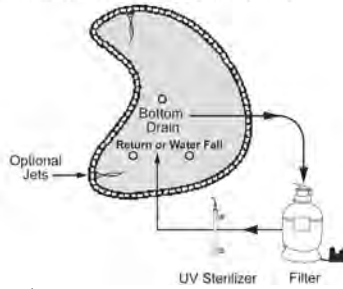

Pick up is too close to return.

RECOMMENDED AQUARIUM LAYOUT

Pickup on the bottom of one side of the tank and return to top of opposite side of tank.

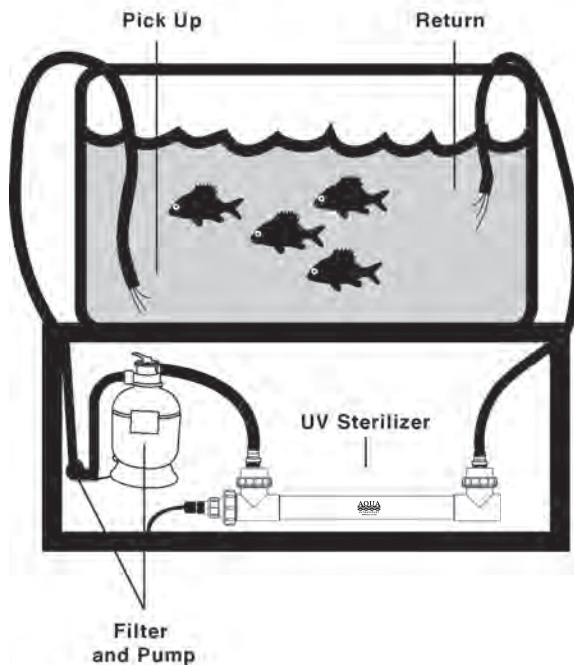

FREQUENTLY ASKED QUESTIONS

Where do I install my UV?

The best place to install your Aqua Ultraviolet Sterilizer is after the filter. If an after the filter installation is not feasible, your sterilizer can be installed before the filter, but it will take a little longer to work. If installed before the filter, be aware that a small rock passing from the pump can break the quartz sleeve. It is recommended that if you install your unit before your filter, you check the UV periodically for any water leakage due to a broken quartz sleeve. Be sure to have adequate pre-filtration to prevent breakage. (A broken quartz sleeve and any damage caused by a broken quartz sleeve is not covered under warranty.)

Do I have to turn my UV off when I clean my filter?

Yes, but only if the chamber is drained or if the water will remain at a stand still for more than 30 minutes. Note: Running longer than the recommended time without water flow can cause extensive damage to the unit that is not covered under warranty.

What should I expect after my UV is installed?

If your Aqua Ultraviolet system is installed after the filter and is properly sized the water should be clear in 3-5 days. If your Aqua Ultraviolet system is installed before the filter the water should be clear in 7-10 days. The green algae on the sides and bottom of the pond will not disappear, this is normal in a pond. The UV does not control this type of algae.

What's the difference between a sterilizer and a clarifier?

As a sterilizer, your Aqua UV system will keep your pond or aquarium water crystal clear, plus you will have the added benefit of bacterial control which will help keep your fish healthy and happy with less risk of disease. As a clarifier the algae in your pond will be reduced, your pond will still have a green tint to it, unless you have 50-75% plant coverage or your pond is in full shade.

Do I install my UV vertically or horizontally?

You can install it either way - (see Installation Instructions Page 13 and 14)

What should my flow rate be on my pond or fresh water aquarium?

The optimum flow rate on your pond or fresh water aquarium is to turn over the volume of water one time every hour to every hour and a half.

What should my flow rate be on my salt water aquarium?

Your flow rate should be 3 to 5 times the volume of water per hour.

Can I use the Wiper System with my saltwater application?

Aqua Ultraviolet does not recommend utilizing Wipers with Salt Water and if utilized in this manner will void warranty on the Wiper parts.

Should I bypass part of my water through the UV and the rest back to the water supply?

No, Our UV's are specifically designed to handle high flow rates for easier installation and the best water quality.

Is this unit submersible?

No, not this specific series.

Does the UV light have any residual effect to the fish?

UV only affects what passes through the chamber. There is no residual effect from UV light.

Does the UV kill good bacteria?

Ultraviolet light does not discriminate about what it destroys. If good bacteria passes by the light it will be destroyed. Beneficial bacteria are colonized in your filter and along the sides and bottom of your pond. The only time those will be affected is if it becomes free floating and passes through the UV.

How often should I change my lamp?

The lamp should be changed after 14 months of continuous use. Use Genuine Aqua UV Lamps or the Warranty is voided.

INSTALLATION INSTRUCTIONS

NOTE: All units are quality tested from the factory. All units are rated up to 50 PSI.

Mount your Aqua Ultraviolet Sterilizer horizontally or vertically on a wall or above ground, on a level and firm surface. Do not lay the system on the ground or where water may puddle. Your Sterilizer should be easily accessible. Do not submerge.

On units with the Wiper option remember to allow enough space to pull the Wiper Rod all the way out.

On all units allow space to change the Lamp and Quartz Sleeve.

Horizontal Installation is preferred since the chamber is more likely to remain flooded with water.

8, 15, 25, 40, 57 Watt Units:

Wiper Option

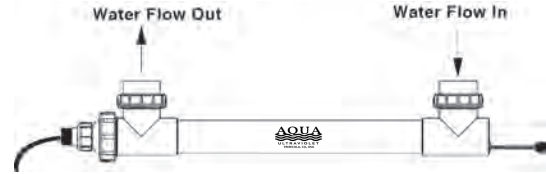
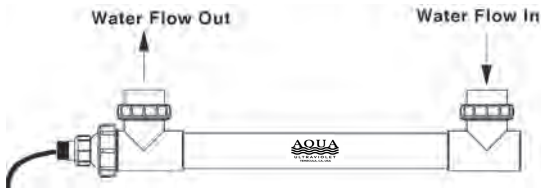

On Wiper Option UV's water should flow into the unit through the opening nearest the end with the wiper ball. This will help ensure that the chamber stays full and the Wiper Rod will not push out.

80, 120 Watt Units:

Wiper Option

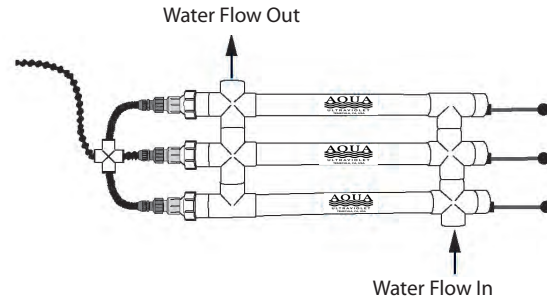
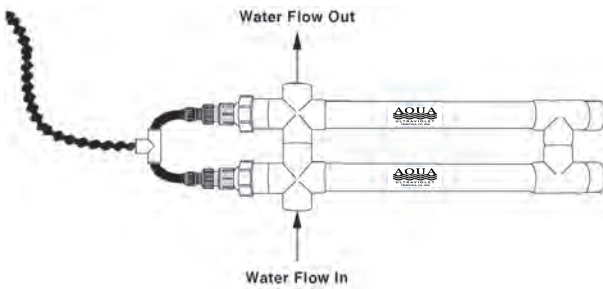

Plumb the water going in from the bottom and out through the top. This will help ensure the chamber stays full of water.

160, 200, 240 Watt Units:

Inlet / Outlet ports should be facing upward.

Wiper Option

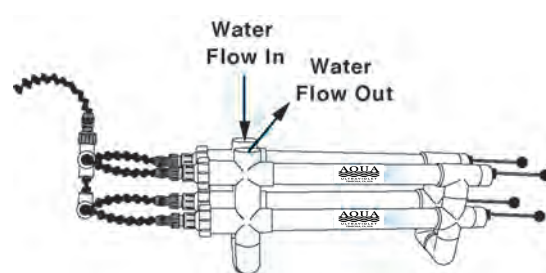
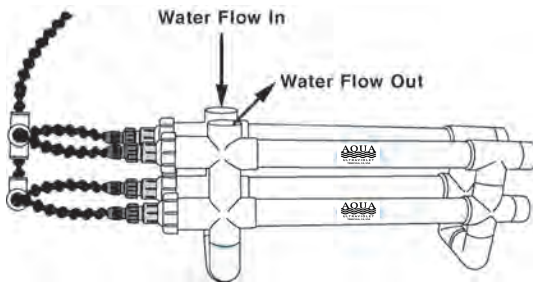

The above are suggestions, if these are inconvenient, either port can be used as the inlet or the outlet. In any installation the pump must be of a sufficient power to keep the chamber full of water so the seals around the wiper nut do not dry out.

Note: If the Wiper Nut Seal is exposed to air or to the lamp it will dry out, crack and leak. This is not covered under warranty.

INSTALLATION INSTRUCTIONS

Vertical Installation

Be careful not to drop the lamp down inside the unit, this can break the Quartz Sleeve. The Quartz Sleeve is not warranted against breakage nor is any damage caused as a result of a broken Quartz Sleeve. (SEE ILLUSTRATION ON PAGE 31.) In a vertical installation Wiper Units should be installed with the wiper portion facing downward.

8, 15, 25, 40, 57 Watt Units:

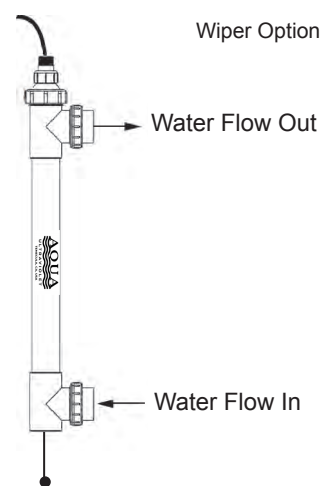
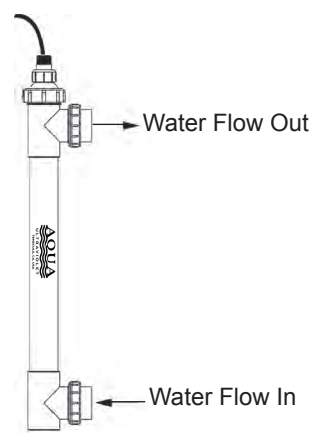

120, 200 Watt Units:

Plumb the water going in from the bottom and out through the top. This will help ensure the chamber stays full of water.

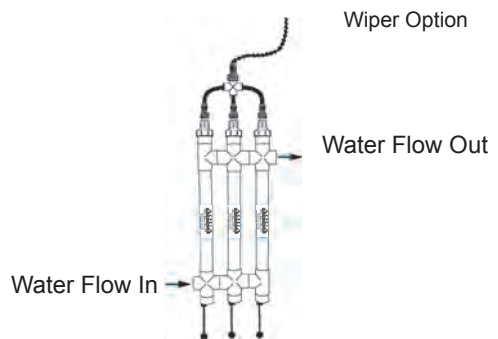
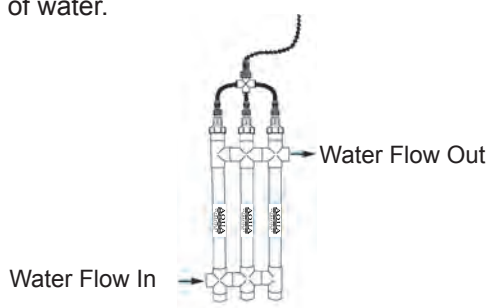

80,160, 240 Watt Units:

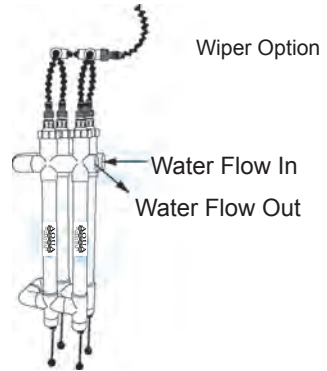
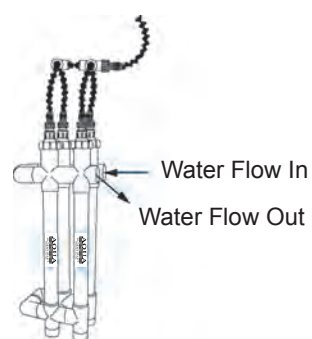

The above are suggestions, if these are inconvenient, either port can be used as the inlet or the outlet. For any installation it is important that the pump flow enough water to keep the UV chamber full; a partially filled chamber allows the seals to dry out including the wiper nut seal on wiper models.

Note: If the Wiper Nut Seal is exposed to air or to the lamp it will dry out, crack and leak. This is not covered under warranty.

INSTALLATION INSTRUCTIONS

1. You can use mounting brackets (A40124 that can be purchased from us) or plumber's straps to attach your unit to a wall or firm surface. Make sure the unit is mounted securely before operating

CAUTION: Your Aqua Ultraviolet unit is not submersible. If this unit falls into the water, turn main power off and then retrieve it. Do not attempt to use this sterilizer if it has been submerged. Do not operate this unit if it has a damaged cord or plug, if it is malfunctioning or if it has been dropped or been damaged in any manner.

2. The UV should be installed after the filter on the return line. This helps ensure that the water is clear of debris and impurities that could inhibit the disinfection process. The UV can be installed before the filter, however, it will take longer to work. Note: You increase the risk of breaking the Quartz Sleeve and Lamp if debris enters the UV unit when installed before your filter.

For 3/4" threaded units:

- a. Locate the barbs included with your unit. Barbs are fitted for either 3/4" or 1/2" hose (see illustration).
- b. The barbs have been Teflon taped for you to prevent leakage. Install barbs, hose and hose clamps. (Hose and hose clamps are not included.)

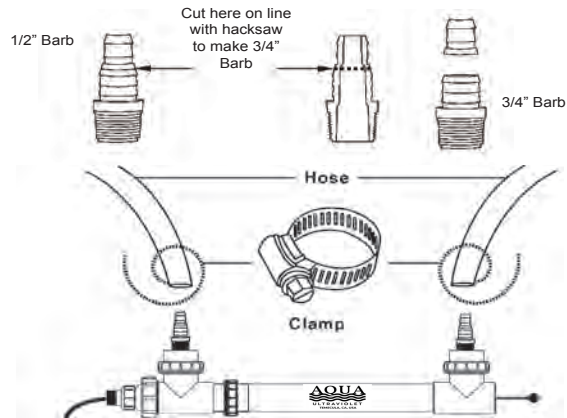

For 2" slip fitted units

8, 15, 25, 40, 57 Watt Units glue existing pipe into the unions provided with unit.

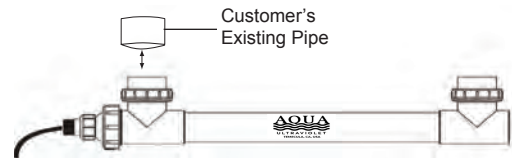

For 2" and 3" Slip Fitted Units:

80, 114, 120, 160, 200, 240 cut 2 pieces of sch 40 2" PVC pipe to the length of 2-3/8" (supplied by customer). This pipe is used to attach the UV sterilizer to the unions that were provided. Use only PVC glue and primer.

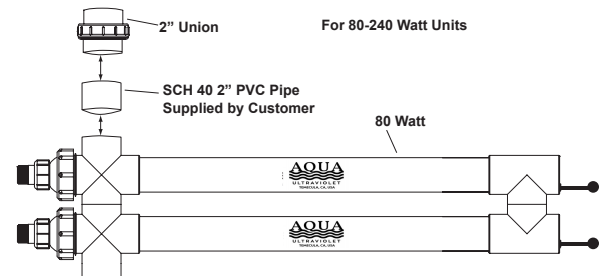

3. Based on your personal plumbing configuration, additional plumbing supplies may be needed

LEAK TEST: Do not install the Lamp or electrical components yet. After all connections have been made, turn on the pump and run for five minutes to check for leaks

- a. If there are no leaks, turn pump off and continue installing the lamp (on page 17). For units 8,15, 25, 57 and 114 watt. For 80 watt and 120- 240 watt continue to electrical installation on page 18.
- b. If unit leaks turn pump off and continue to trouble shooting leaks on page 16.

TROUBLE SHOOTING LEAKS

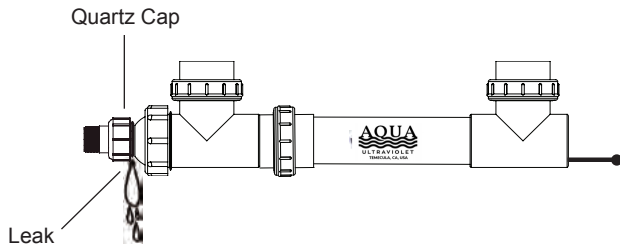

Leaks from Quartz Cap / Rubber Seal

Undo Quartz Cap and push Rubber Seal into the Sterilizer body evenly. Half of the Rubber Seal will still be in view. Screw on the Quartz Cap and hand tighten. Do not use a pipe wrench, pliers or any other tool. Hand-tighten only. Do not use any lubricant.

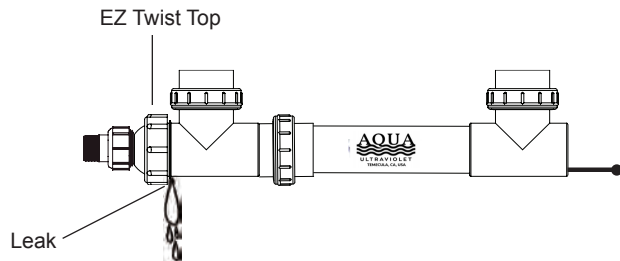

Leaks from the EZ – Twist Top

Check that the O-ring is in the EZ-Twist Top. Hand tighten EZ-Twist Top until leak stops. Do not use any lubricant.

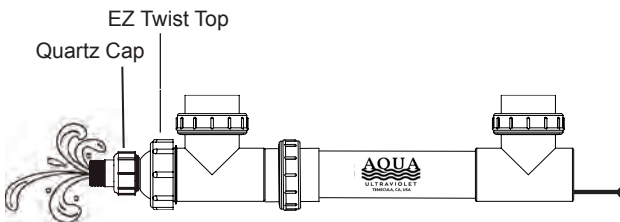

Leaks from Center of Quartz Sleeve

The Quartz Sleeve is broken and needs to be replaced. Neither the broken Quartz Sleeve nor any damage caused as a result of a broken Quartz Sleeve is covered under warranty. Contact your dealer for a replacement. (See Replacing the Quartz Sleeve on page 24).

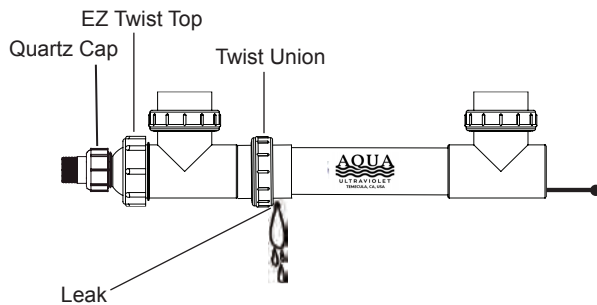

Leaks from the Twist Union

Hand tighten union until leak stops. If leak persists, turn off the pump, take the unit offline. Set the unit on a firm surface. Loosen the Twist union. Pull the unit apart straight. Do not pull the unit apart at an angle or the Quartz Sleeve will break (this is not covered under warranty). Be sure that the o-ring is seated in the inside of the union. Reconnect the twist union, hand tighten only. Reconnect unit inline.

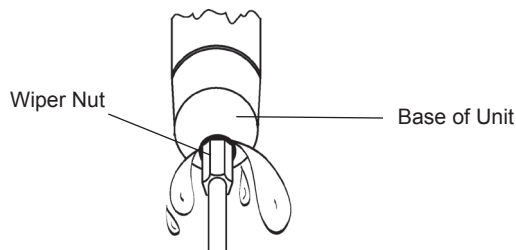

Leaks from outside the Wiper Nut

If you notice a leak between the base of the unit and the nut, the Wiper Nut may need more teflon tape for a tighter seal. If the leak persists, please contact our customer service department at (800) 454-2725 for assistance.

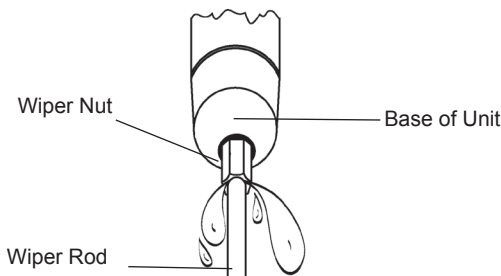

Leaks from the Wiper Rod

If you notice a leak between the Wiper Nut and the Wiper Rod, the seal may be cracked or damaged. If this occurs, please contact our customer service department at (800) 454-2725 for assistance.

INSTALLING THE LAMP For 8, 15, 25, 40, 57 and 114 Watt Units



NOTE: If you touch the Lamp use denatured alcohol and a soft cloth to clean the Lamp. If you do not clean the Lamp the fingerprints will become etched into the glass which will diminish UV output and may cause premature lamp failure.



NOTE: Lamps and Quartz Sleeves should be handled with care. Lamps and Quartz Sleeves are not warranted against breakage or damage.



WARNING: Do not install the Lamp at an angle (even a slight angle); this may cause a U shaped crack at the end of the Quartz Sleeve, or possible breakage of the Lamp. If this should happen, do not proceed with the installation. Purchase a new Quartz Sleeve or Lamp from your dealer and refer to the proper installation instructions.



NOTE: Do not force the Lamp into the Quartz Sleeve.

1. Unscrew the Davis Connector located behind the Transformer Cap, this allows your Transformer Cap to spin freely.

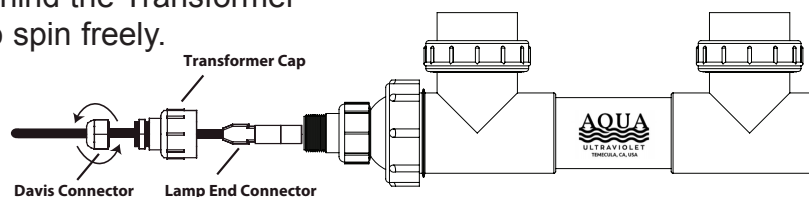

2. Plug the Lamp flush into the Lamp End Connector before inserting the Lamp into the unit. If the Lamp is not plugged in all the way it may cause damage to the unit and is not covered under warranty.

3. Insert the Lamp straight into the Quartz Sleeve. Be careful, inserting the Lamp at an angle, even a slight angle, can cause a "U" shaped crack in the Quartz Sleeve. Quartz Sleeves are not warranted against breakage or damage.

4. Twist the Transformer Cap onto the Quartz Cap. Do not over tighten. This is a connection only and is not in contact with water.

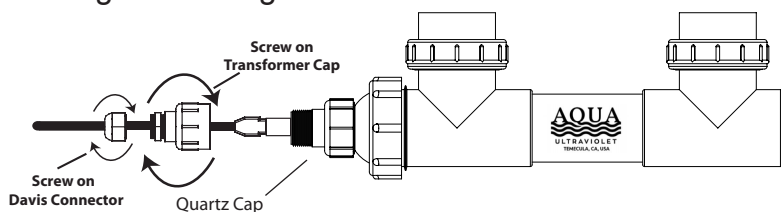

5. Tighten the Davis Connector back on to the Transformer Cap.
6. **FINAL LEAK CHECK:** Do not plug the Sterilizer into power yet, turn on the pump, let water run for 5 minutes and check for leaks. (See page 16 for trouble shooting leaks).
7. Once a leak test is completed, and there are no leaks, plug the Transformer into a GFCI outlet.

ELECTRICAL INSTALLATION For 80, 120, 160, 200, 240 Watt Units

- 1. Cover Removal:** Remove the cover from the Transformer Box to allow access to screw holes located on the back panel of the box. The cover slides down.
- 2. Mounting:** Mount the Transformer vertically on to a wall or other sturdy surface a minimum of 4 feet away from any dwelling. Make sure the Transformer is close enough to attach to the UV unit.



- 3. 220V Transformer:** Must be hard wired into a dedicated line of the appropriate voltage and hertz.
- 4. 110V Transformer:** Plug into 3 prong G.F.C.I. Outlet.

MULTI LAMP UNITS ELECTRICAL INSTALLATION

- 1. DISCONNECT THE HUBL CONNECTOR:** Unscrew the Hubl Connector located just above the Transformer Cap. This will allow the transformer cap to turn without kinking the harness.

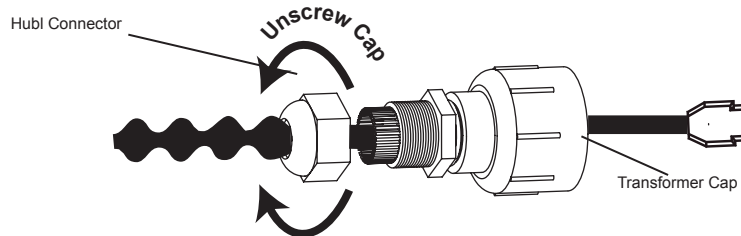

- 2. CONNECT THE LAMP:** Plug a Lamp into each of the Lamp End Connectors, located at the end of the harness, one at a time. Make sure the Lamps are plugged in all the way flush with the Lamp End Connectors. If the Lamps are not plugged in all the way it may cause damage to the unit and is not cover under warranty.

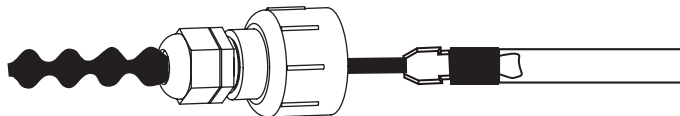

- 3. Insert the Lamp straight into the Quartz Sleeve. Be careful, inserting the Lamp at an angle, even a slight angle, can cause a "U" shaped crack in the Quartz Sleeve. Insert one lamp at a time.**

MULTI LAMP UNITS ELECTRICAL INSTALLATION

4. **CONNECT THE TRANSFORMER CAP:** Twist the Transformer Cap onto the Quartz Cap. Do not over tighten. This is a connection only and is not in contact with water so it does not have to be tight. Do not use a pipe wrench, pliers or any other tool.

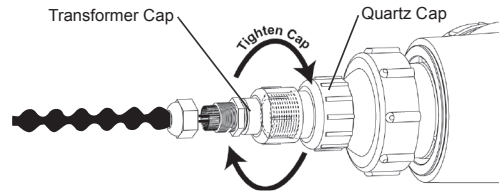

5. Tighten the Hubl Connector back onto the transformer cap.

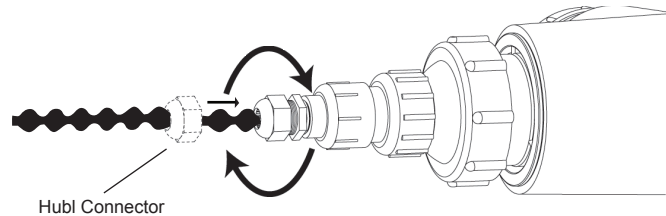

Repeat to install each lamp.

FINAL LEAK CHECK: Do not plug the sterilizer into power yet, turn on pump and check for leaks again. For illustrations, **SEE PAGE 16.**

- a. If there are no leaks, continue with electrical installation & turn power on to UV.
- b. If you have a leak, return to Trouble Shooting Leaks on page 16. Carefully examine this unit after installation. This unit should not be connected to electricity if there are any leaks. If leak continues contact Support at Aqua Ultraviolet **(800) 454-2725** or **(951) 296-3480**



CAUTION: Do not look at or handle UV Lamps when lit outside of the housing. Considerable Ultraviolet energy is emitted which may produce severe sunburn and/or conjunctivitis. As long as the UV light is in its housing it is 100% safe for humans and fish.



NOTE: The average life expectancy of Aqua Ultraviolet Lamps is 14 months of continuous operation. After 14 months the lamp may still light, but the UV has diminished.



NOTE: We recommend that the UV sterilizer be used in continuous operation for 24 hours a day, 7 days a week. Frequent starts and stops may shorten the life of your Lamps.



WARNING: If you are medicating your fish, we recommend shutting down the sterilizer as the UV Radiation may affect the treatment.



CAUTION: Do not use the Aqua Ultraviolet Sterilizer for anything other than its intended use.



CAUTION: Always turn off the pump and disconnect electricity from the unit prior to any maintenance.

Option 1: If you are going to continually run water through your unit and it will be exposed to freezing temperatures be sure to install winterizing caps (sold separately) on the unit and take all the internal parts inside (Quartz Sleeve, EZ-Twist Top, Quartz Cap, Lamps, Rubber Seals, and Small Transformers. NEMA Transformer Boxes may be left outside.

Take these parts inside

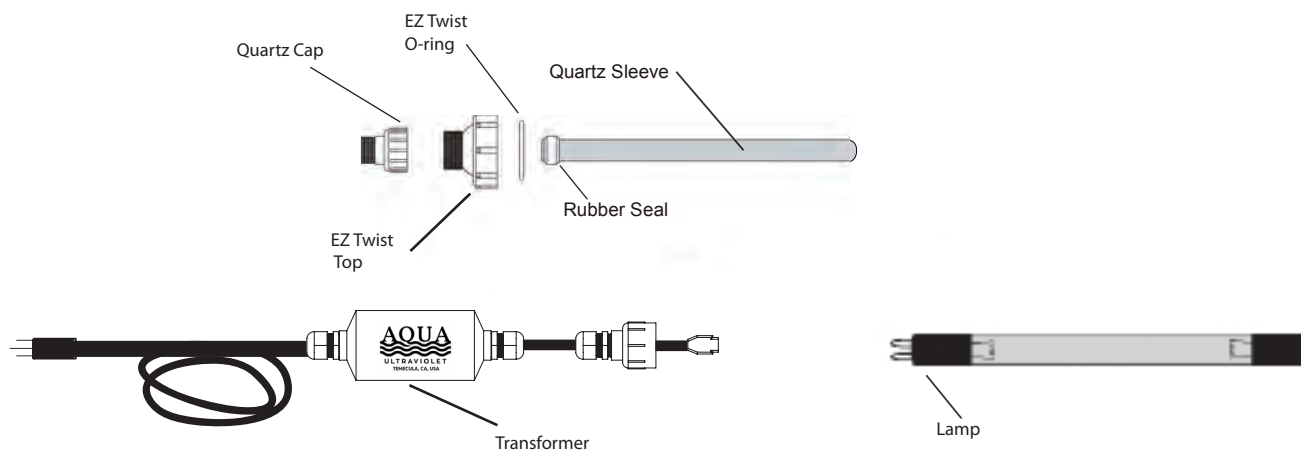

Option 2: If you are not flowing water through your system, use a winterizing cap, drain the unit completely and take the internal parts inside. If the unit is not completely drained, the water will freeze and crack the housing. This is not covered under warranty.

Option 3: If you don't have a winterizing cap and are not going to run water through the system, remove the Lamp, disconnect unions and take the Sterilizer inside. Store the Lamp separately to avoid breakage.

Note: Replace rubber seal when putting the unit back into use.

MAINTENANCE



CAUTION: Always turn off the pump and disconnect electricity from the unit prior to any maintenance.

Changing the Lamp.

*** We recommend changing the purple seal on the quartz sleeve when you change your lamp & after winterizing**

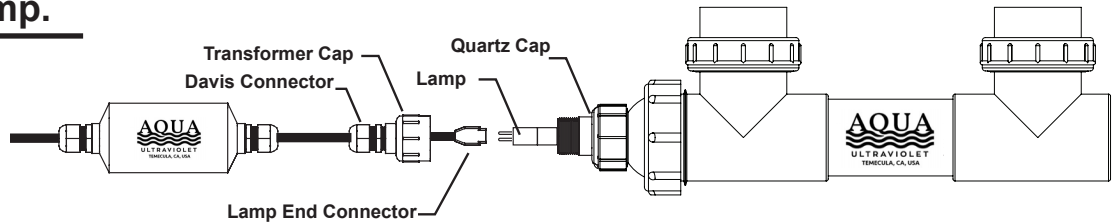

1. Unplug the UV from the power source and turn off the pump.

2. Unscrew the Davis or Hubl Connector located behind the Transformer Cap, this allows your Transformer Cap to spin freely.

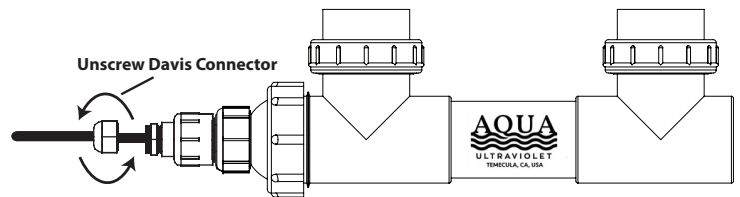

3. Twist off the Transformer Cap.

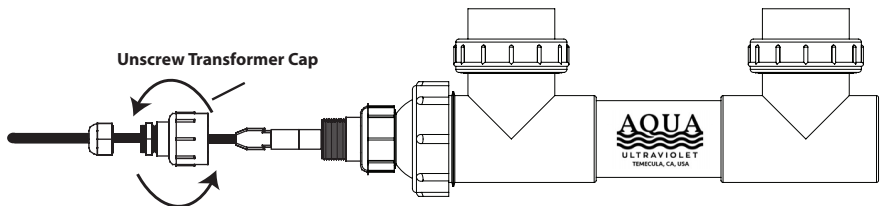

4. Slide Lamp out, be careful not to slide the Lamp out at an angle, even a slight angle, this may cause a "U" shaped crack at the opening of the Quartz Sleeve, or possible breakage of the Lamp. A Broken Lamp or Quartz Sleeve are not covered under warranty.

5. Disconnect the Lamp End Connector from the old Lamp.

6. Plug the new Lamp flush into the Lamp End Connector. If the Lamp is not plugged in all the way it may cause damage to the unit and is not covered under warranty. Use Genuine Aqua Ultraviolet lamps or the warranty is voided.

7. Insert the Lamp straight into the Quartz Sleeve. Be careful, inserting the Lamp at an angle, even a slight angle, can cause a "U" shaped crack in the Quartz Sleeve.

8. Twist on the Transformer Cap. Hand tighten only. This is a connection only and is not in contact with water.

9. Tighten the Davis or Hubl Connector located behind the Transformer Cap.

10. FINAL LEAK CHECK: Do not plug the Sterilizer into power yet, turn on the pump, let water run for 5 minutes and check for leaks.

11. Once a leak test is completed and there are no leaks, plug the Transformer into a GFCI outlet. Warranty is void if not plugged into a GFCI.

CLEANING THE QUARTZ SLEEVE

1. Unplug the UV from the power source and turn off the pump.

2. Unscrew the Davis or Hubl Connector located behind the Transformer Cap, this allows your Transformer Cap to spin freely.

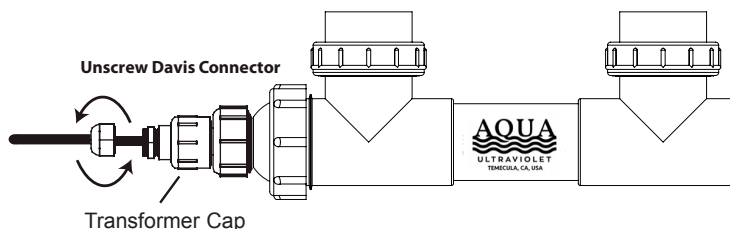

3. Twist off the Transformer Cap.

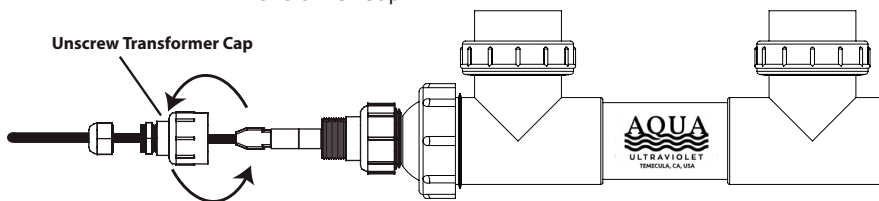

4. Slide Lamp out, be careful not to slide the Lamp out at an angle, even a slight angle, this may cause a “U” shaped crack at the end of the Quartz Sleeve, or possible breakage of the Lamp. Set the lamp on a secure level surface to avoid breakage.

For Units Without Wipers (for Wiper units, see page 23)

5. Remove the E-Z Twist Top. The Quartz Sleeve Assembly will come out with it. Be careful to pull it out straight.



NOTE: The Lamps and Quartz Sleeves should be handled with care. Lamps and Quartz Sleeves are not warranted against breakage and damage.

6. The Quartz Sleeve can be cleaned with Lime Away, CLR or similar products. Do not use any type of abrasive substance on the Quartz Sleeve as it may scratch the Quartz.

7. Replace the rubber seal.

8. To reinstall the Quartz Sleeve, carefully insert the Quartz Sleeve into the end of the UV body. Be sure the Quartz Sleeve is seated in the bottom of the UV Unit.

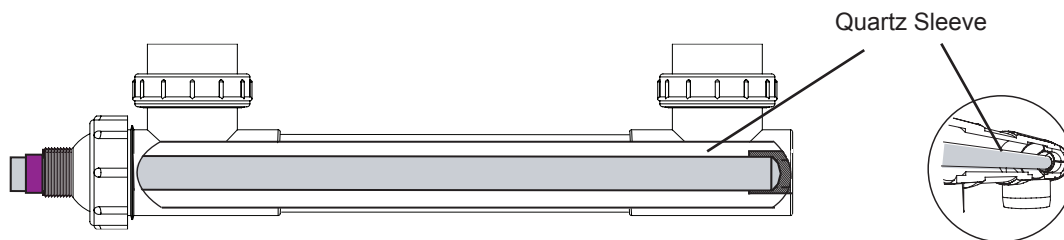

9. Screw on the E-Z Twist Top. Do not use a pipe wrench, pliers or any other tool on this unit. Tighten by hand only. Re-install the Lamp as Shown on page 21, starting at #6.

CLEANING THE QUARTZ SLEEVE FOR WIPER UNITS

1. Unplug the UV from the power source and turn off the pump.

2. Unscrew the Davis or Hubl Connector located behind the Transformer Cap, this allows your Transformer Cap to spin freely.

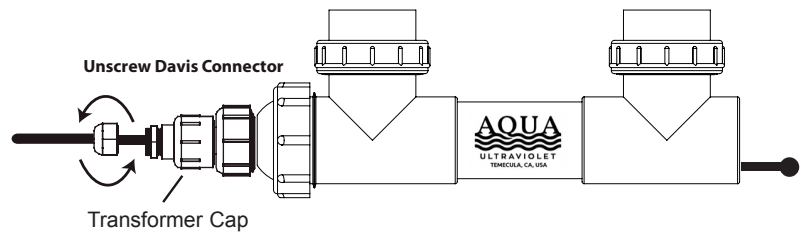

3. Twist off the Transformer Cap.

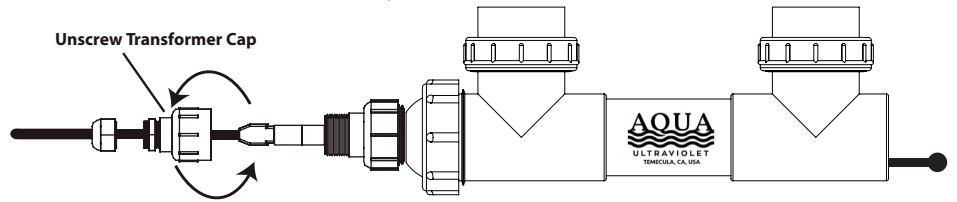

4. Slide Lamp out, be careful not to slide the Lamp out at an angle, even a slight angle, this may cause a "U" shaped crack at the end of the Quartz Sleeve, or possible breakage of the Lamp. Set the lamp on a secure level surface to avoid breakage.

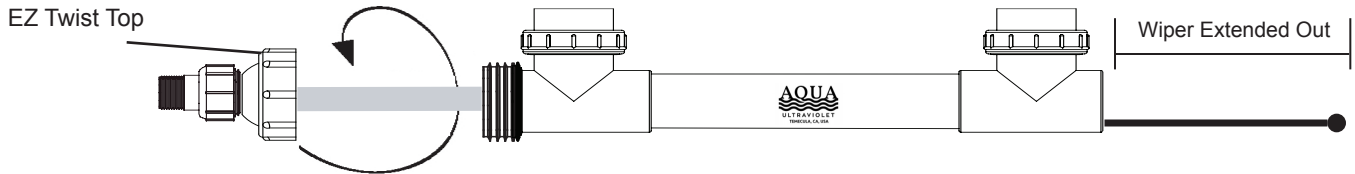

5. Pull the Wiper Rod completely out (fully extended)

6. Twist off the large nut (E-Z Twist Top). This will release the Quartz Sleeve and the assembly will still be intact.

7. The Quartz Sleeve can be cleaned with Lime Away, CLR or similar products.

Note: Do not use any type of abrasive substance on the Quartz Sleeve as it may scratch the quartz.

8. Once the sleeve has been cleaned, wet the Wiper Blades and the outside of the Quartz Sleeve.

Note: Use water only do not use any lubricant.

9. Push the rod completely into the unit and insert Quartz Sleeve assembly through the blade(s). Please note units that use 40 Watt Lamps have 2 Wiper Blades, be sure to insert Quartz Sleeve into both Blades. Be sure the Quartz Sleeve is seated in the bottom of the UV Body.

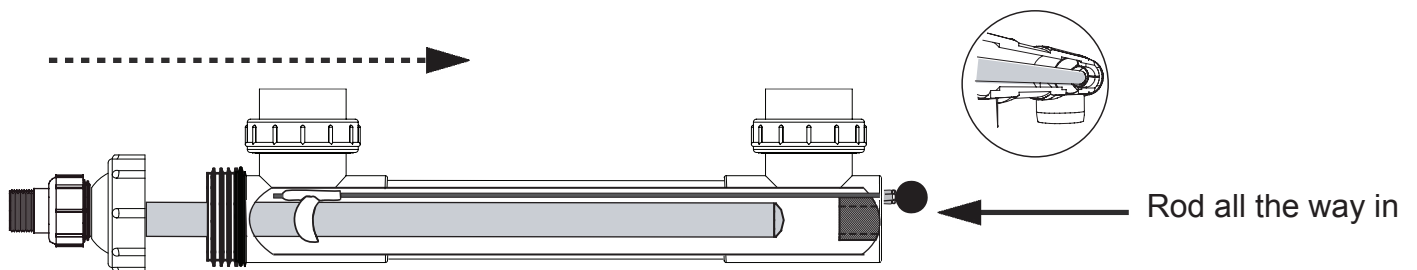

10. Screw on the EZ Twist top. Do not use a pipe wrench, pliers or any other tool on this unit. Tighten by hand only. Re-Install the lamp as shown on page 21, starting at #6.

REPLACEMENT OF THE QUARTZ SLEEVE

1. Unplug system, turn pump off and drain housing. Remove Lamp and Transformer.

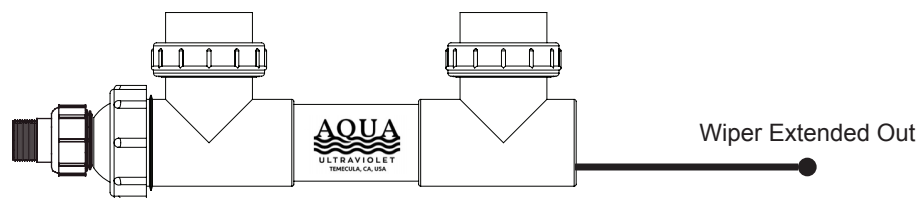

Note: If you have the Wiper option, pull the Wiper Rod out to be fully extended.

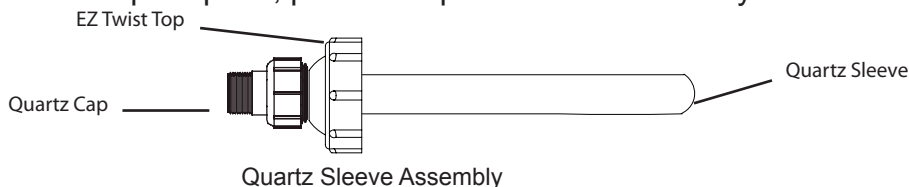

2. Untwist E-Z Twist Top. This will release the Quartz Sleeve Assembly. Pull The Quartz Sleeve Assembly straight out of the housing.
3. Untwist Quartz Cap. Push Quartz Sleeve up through E-Z Twist Top. Be careful not to break the Quartz Sleeve. Handling broken glass can cause injury. If your Quartz Sleeve is broken protect your hands before servicing.

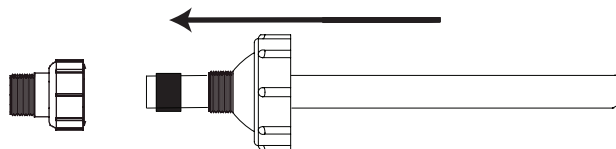

4. Discard old Quartz Sleeve and Rubber Seal, be sure to use only genuine Aqua UV Quartz Sleeves.
5. Re-install E-Z Twist Top without Quartz Sleeve. Slide Quartz Sleeve into the housing. Be sure to center the quartz sleeve into the seat at the bottom of the unit. Note if you have the Wiper Option: Push the rod completely into the unit. Wet the outside of the Quartz Sleeve and insert through the blade(s). Please note units that use 40 Watt Lamps have 2 Wiper Blades, be sure to insert Quartz Sleeve into both Blades. Be sure the Quartz Sleeve is seated in the bottom of the UV Body.

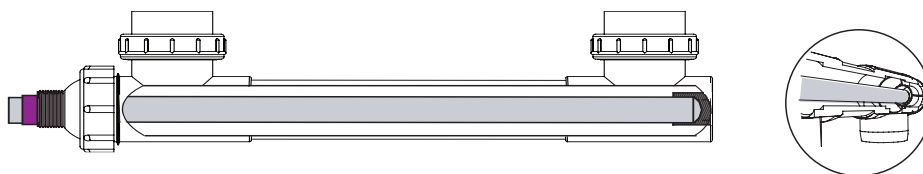

6. Gently push the Quartz Sleeve and Rubber Seal in to the E-Z Twist Top until only ½ the rubber seal is visible.

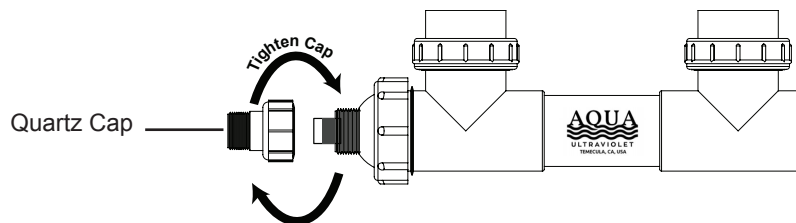

7. Twist on the Quartz Cap. DO NOT use a pipe wrench, pliers or any other tool on this unit. Tighten by hand only.

To Reinstall the Lamp

Go to step #6 under changing the Lamp on page 21.

WIPER MAINTENANCE

NOTE: The Wiper Rod should be pulled at least once a week for optimum performance. The pump does not need to be turned off. Do not pull the Wiper Rod on a dry unit. Always wet the Quartz Sleeve first.

REPLACING THE WIPER BLADES AND WIPER NUT

It is recommended that the wiper blades and Wiper Nut be replaced every time you change your lamp at 14 months of use. Also, when reinstalling the sterilizer after winter.

1. Unplug the unit and turn off the pump.
2. Unscrew the Davis or Hubl Connector located behind the Transformer Cap.
3. Twist off the Transformer Cap.
4. Slide the Lamp out while still connected to the Transformer. Be careful not to slide the Lamp out at an angle, this may cause a "U" shaped crack at the end of the Quartz Sleeve or possibly break the Lamp. **Do not force the Lamp out of the Quartz Sleeve, any force would be an indication of an improper removal of the Lamp!!**
5. Drain the housing.
6. Pull the Wiper Rod completely out (fully extended).

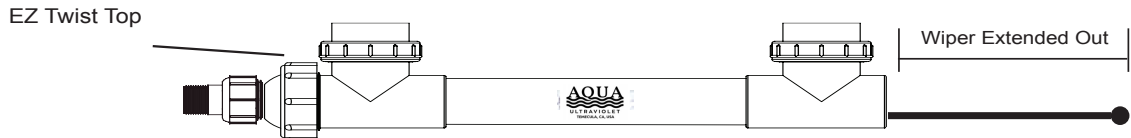

7. Twist off the large cap (EZ twist top) this will release the Quartz Sleeve and the assembly will still be intact.

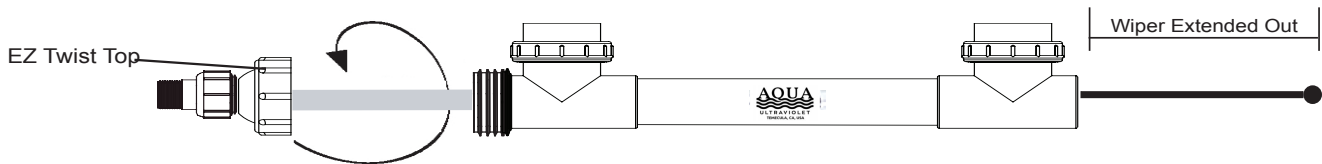

8. Remove the Quartz Sleeve Assembly.

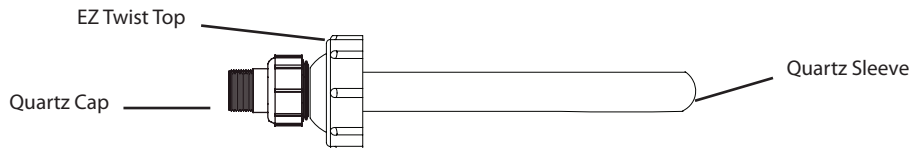

9. Unscrew the wiper ball and remove the hex nut.

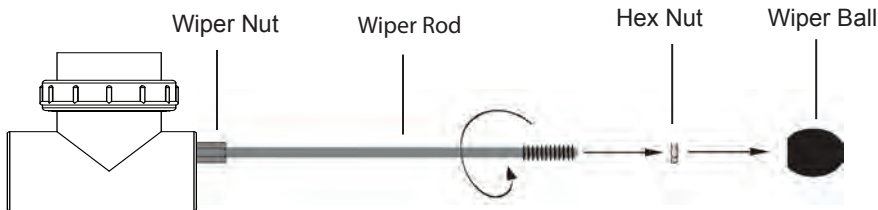

10. Using a 1/2" wrench, unscrew and remove the wiper nut located at the base of the unit. Be very careful not to cross thread.

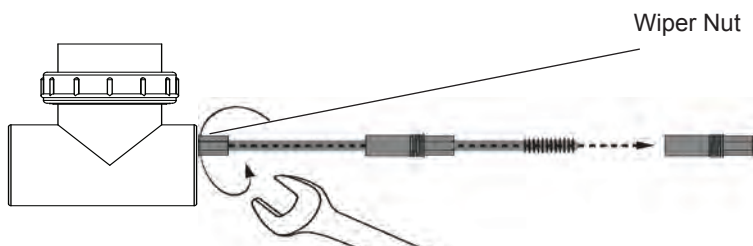

WIPER MAINTENANCE

11. Pull the Wiper Rod from the large open end of the unit.

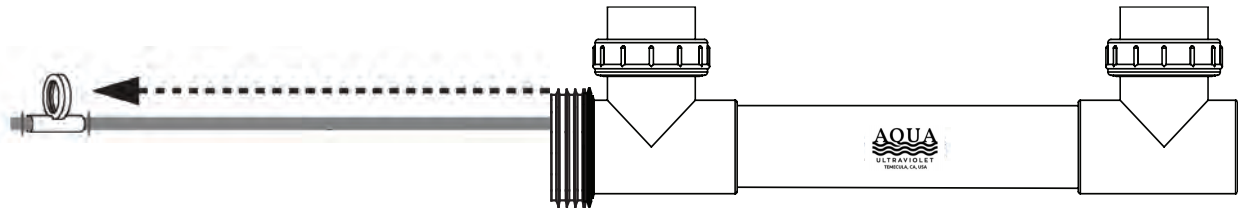

12. Using needle nose pliers, remove the top C-Clip from Wiper Rod. This will release the Wiper Blade.

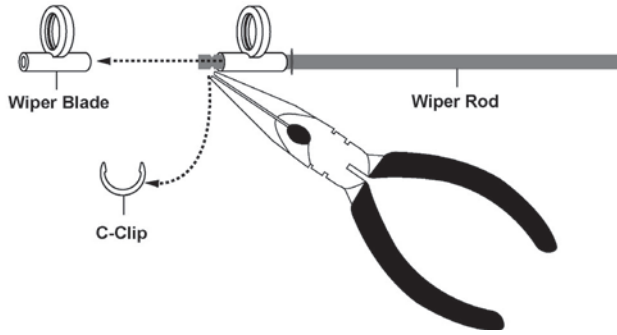

13. Remove and replace Wiper Blade.

14. Using needle nose pliers replace the top C-Clip into the top notch on the rod. Make sure the blade is secure.

Do not use the old c-clip or it will fall off.

15. Insert rod assembly back in through the large open end of the unit (from which it was removed) and guide rod out through hole at the base of the unit.

16. Screw new Wiper Nut in over the threads at the end of the rod and slide it the rest of the way down, until the nut is resting on the base of the unit. **NOTE:** Make sure to **SCREW** the nut over the threads on the rod or the seal inside of the wiper unit can be compromised causing the unit to leak. Do not use any lubricants.

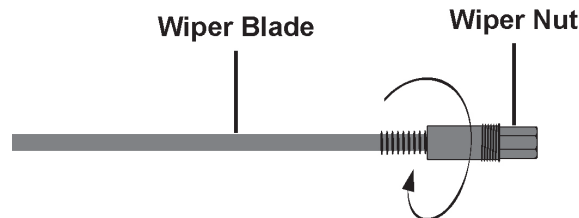

17. Using a 1/2" wrench screw the nut into the base of the unit. Be careful not to cross thread.

18. Re-install Hex Nut and Wiper Ball on the end of the rod.

19. Wet Wiper Blade and the outside of the Quartz Sleeve.

20. Push rod completely into the unit and insert Quartz Sleeve assembly through the blade. **PLEASE NOTE:** 40 Watt units have 2 wiper blades, be sure to insert in both blades. Make sure the Quartz Sleeve is inserted in the seat at the bottom of the unit. Hand tighten EZ twist cap.

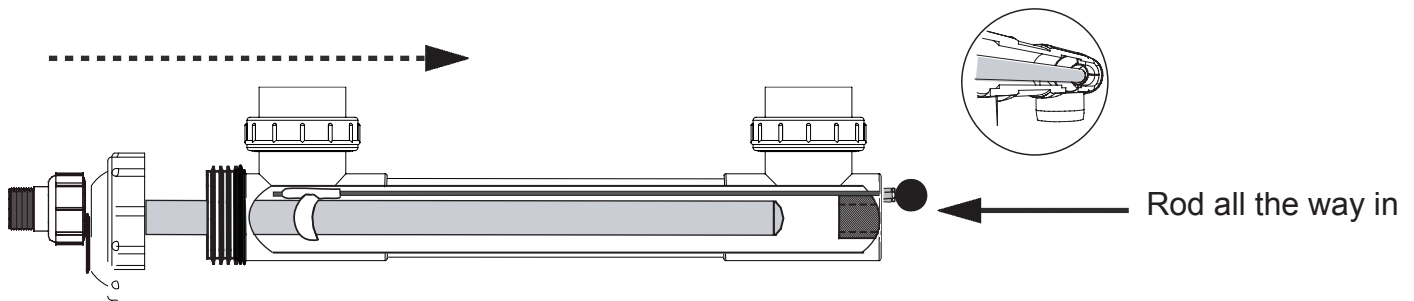







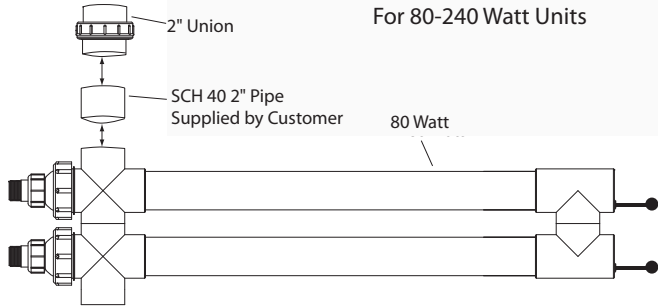
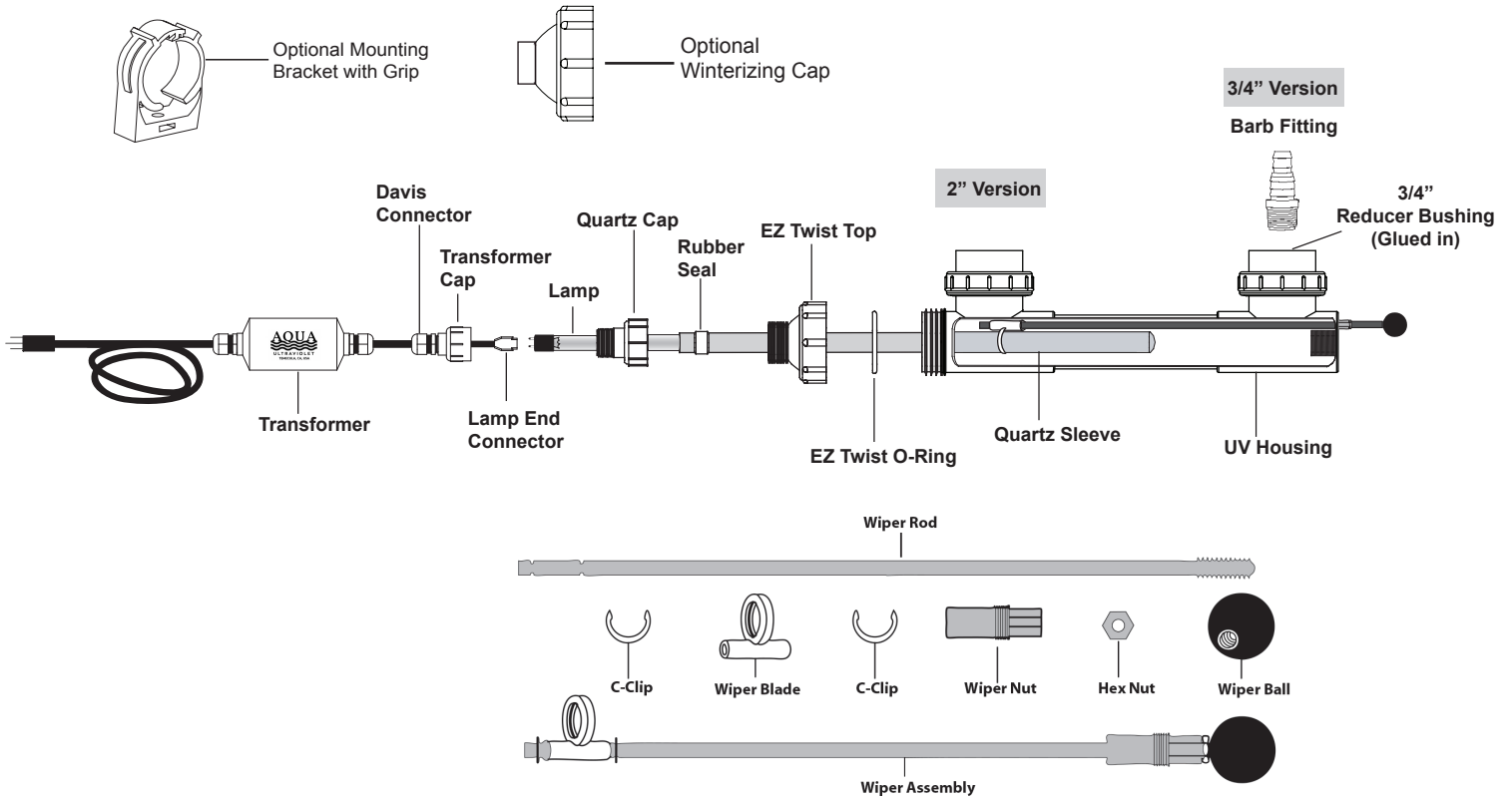



*Aqua Ultraviolet does not recommend utilizing Wipers with Salt Water and if utilized in this manner will void warranty on the Wiper parts.

PARTS LIST

Use genuine Aqua Ultraviolet Parts or the warranty is voided.



UV LAMPS	PART NUMBER
 8 Watt	11-5/8" A20008
 15 Watt	11-5/8" A20015
 25 Watt	17-1/2" A20025
 40 Watt	33-1/2" A20040
 57 Watt	17-1/2" A20057

UV QUARTZ SLEEVES	PART NUMBER
 8 Watt	15" A10008
 15 Watt	15" A10015
 25 Watt	19" A10025
 40 Watt	36" A10040
 57 Watt	19" A10057

PART #	Description
A40073	Wiper Ball
A40090	Wiper Hex Nut
A40021	Wiper Nut
A40019	8/15 Watt Wiper Rod
A40010	25/57 Watt Wiper Rod
A40013	40 Watt Wiper Rod
A40017	Wiper Blade With Plastic Clips
A40172	Wiper Blade With Metal Clips
A40089	Metal C-Clip for Wiper Blade (2)
A40180	Plastic C-Clip for Wiper Blade (2)
A40032	2" Union, White

PART #	Description
A40054	Barb Fitting 3/4"
A40124	Mounting Clip Grip Hold
A40014	O-Ring for EZ Twist Top
A40011	Quartz Cap, Clear
A40004	Rubber Seal, Purple
A40068	EZ Twist Top, Black w/ O-Ring
A40012	EZ Twist Top, White, w/ O-Ring
A40007	Winterize Cap w/ O-Ring
A40116	2" Union, Black

PARTS LIST TRANSFORMERS

THE CLASSIC SERIES INLINE TRANSFORMERS

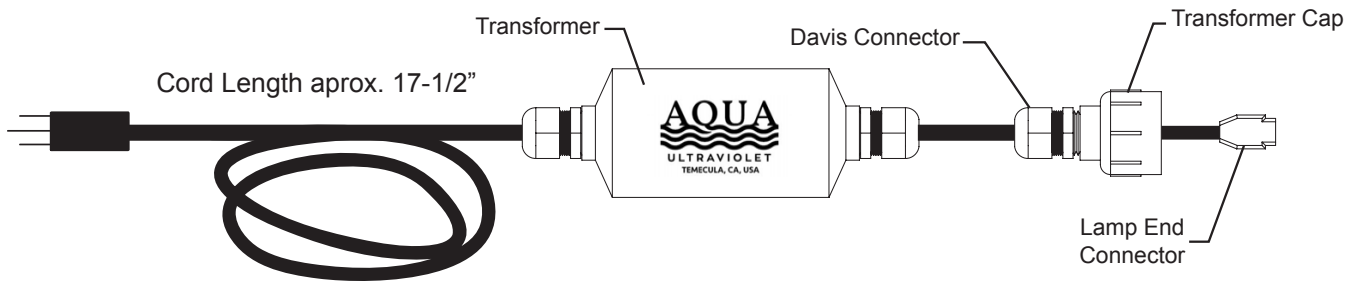

Cords not sold separately

THE CLASSIC SERIES NEMA TRANSFORMERS

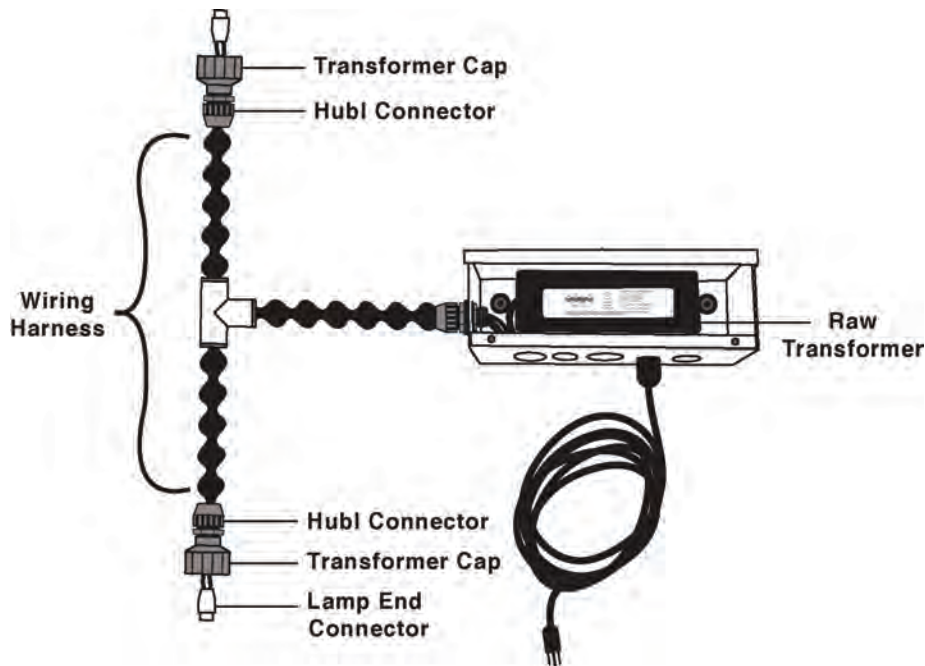

PART #	Description
A40002	Lamp End Connector
A40109	Davis Connector 8/15/25 Watt
A40349	Davis Connector 40 Watt & up
A30007	8W Transformer
A30014	15W Transformer
A30024	25W Transformer
A30044	40W Transformer
A30055	57W Transformer

PART #	Description
A30045	40W NEMA Transformer
A30056	57W NEMA Transformer
A30080	80W NEMA Transformer
A30120	120W NEMA Transformer
A30160	160W NEMA Transformer
A30200	200W NEMA Transformer
A30240	240W NEMA Transformer
A30042	RAW 40 Watt Transformer
A30058	RAW 57 Watt Transformer
A30082	RAW 80 Watt Transformer

PART #	Description
A40088	Hubl Connector
A40002	Lamp End Connector
A40113	Transformer Cap Black
A40062	Wiring Harness 40 Watt
A40063	Wiring Harness 57 Watt
A40065	Wiring Harness 80 Watt
A40106	Wiring Harness 114 Watt
A40066	Wiring Harness 120 Watt
A40092	Wiring Harness 160 Watt
A40093	Wiring Harness 200 Watt
A40094	Wiring Harness 240 Watt

* NEMA transformers are the entire Transformer component. Complete transformers come with a NEMA box, RAW transformer, wiring harness, hubl connector, transformer cap, lamp end connector, and power cord.

PARTS LIST/ Swimming Pool & Spa Units

Use genuine Aqua Ultraviolet Parts or warranty is voided

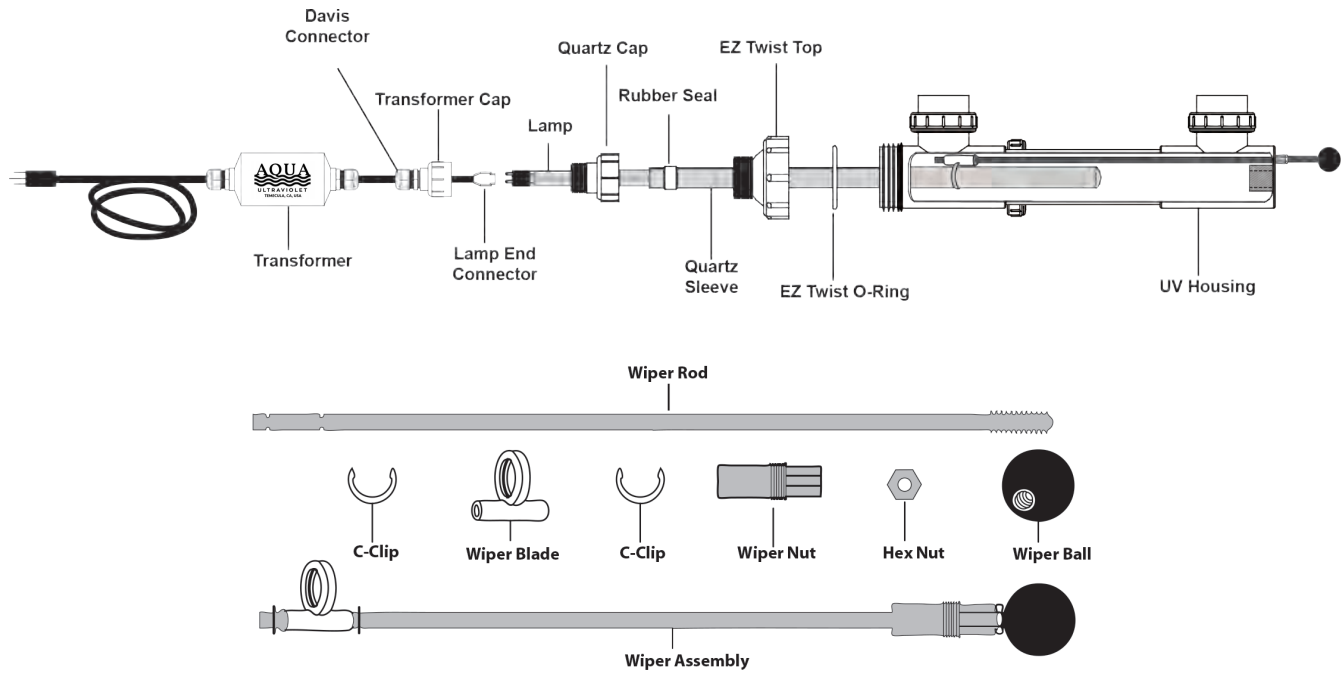

Wiper Assembly Pictured is for reference only-not sold as a set

 Wiper Plug - Use when removing Wiper Assembly

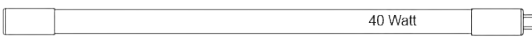
UV LAMPS	LENGTH	PART #
 25 Watt	17 1/2"	A20025
 40 Watt	33 1/2"	A20040

UV QUARTZ SLEEVES	LENGTH	PART #
 25 Watt	25-1/2"	A10019
 40 Watt	36"	A10040

PART #	Description
A40073	Wiper Ball
A40090	Wiper Hex Nut
A40021	Wiper Nut with Seal
A40231	Wiper Rod, for SP 25 Watt Unit
A40013	40 Watt Wiper Rod
A40017	Wiper Blade With Plastic Clips
A40172	Wiper Blade With Metal Clips
A40089	Metal C-Clip for Wiper Blade (2)
A40180	Plastic C-Clip for Wiper Blade (2)
A40082	Union, 3" for Unit Slip x Slip
A40029	Union O-Ring, 3"

PART #	Description
A40230	Plug for Wiper Units
A40011	Quartz Cap, Clear w/ Ring
A40004	Rubber Seal, Purple
A40012	EZ Twist Top, White, w/ O-Ring
A40014	O-Ring for EZ Twist Top

PARTS LIST/ Swimming Pool & Spa Units

Use genuine Aqua Ultraviolet Parts or warranty is voided

Inline Transformer 120V/60Hz

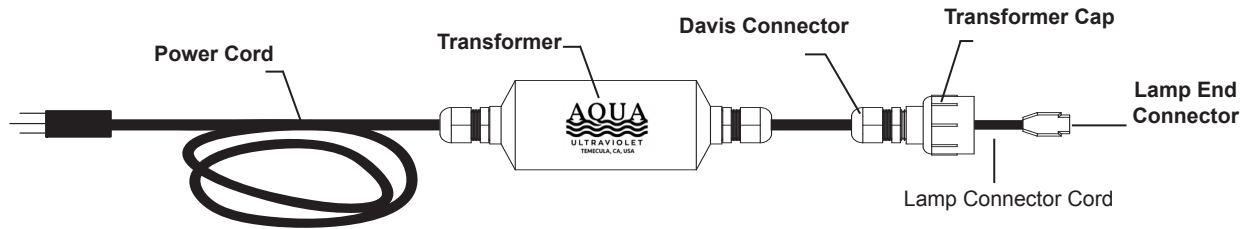

Inline Transformer 220V/60Hz

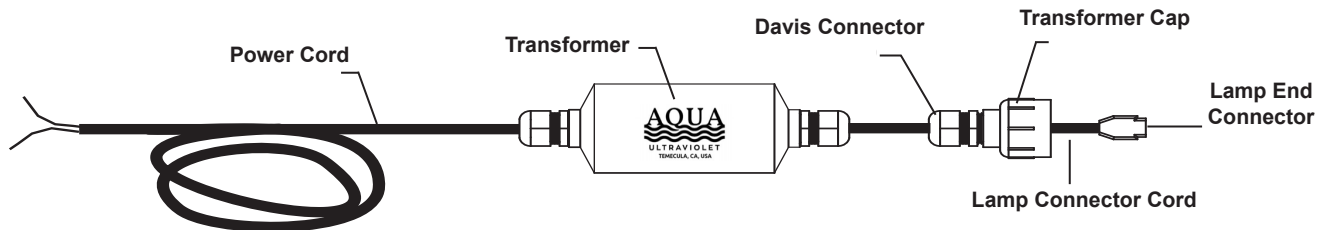

PART #	DESCRIPTION
A40109	Davis Connector 300VAC for 25W
A40349	Davis Connector 600VAC for 40W
A40113	Transformer Cap, Black
A40002	Lamp End Connector
A30024	25W Transformer, Black, 120V/60Hz
A30036	25W Transformer, Black, 220V/60Hz
A30044	40W Transformer, Black, 120V/60Hz
A30049	40W Transformer, Black, 220V/60Hz

INCORRECT INSTALLATIONS

The Following will Damage the Unit's Electrical Components

Incorrect: EZ Twist Top Over Rubber Seal
See Page 24 for Proper Quartz Sleeve installation

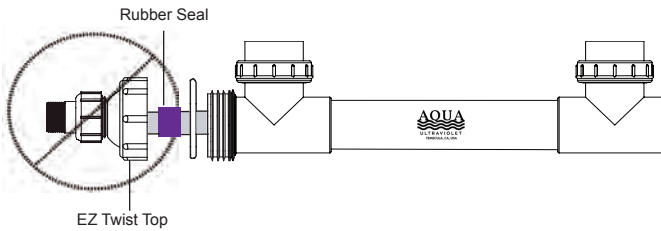

Incorrect: Quartz Sleeve is Outside of Wiper Blade
See Page 23 for Proper Quartz Sleeve installation

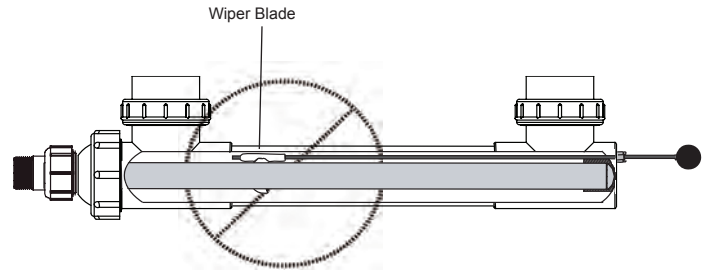

Incorrect: Rubber Seal is Outside of Quartz Cap
See Page 24 for Proper Quartz Sleeve installation

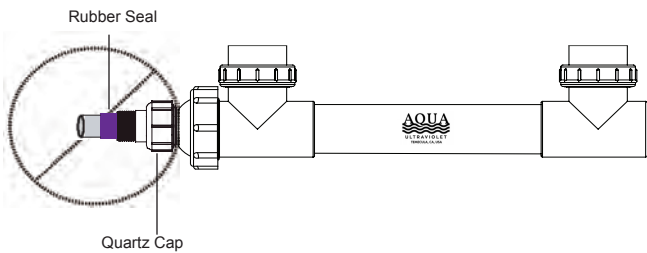

Incorrect: 40 Watt and Multi-Units with Wipers.
One Blade over the Quartz Sleeve and One Blade Outside of the Quartz Sleeve
See Page 23 for Proper Quartz Sleeve installation

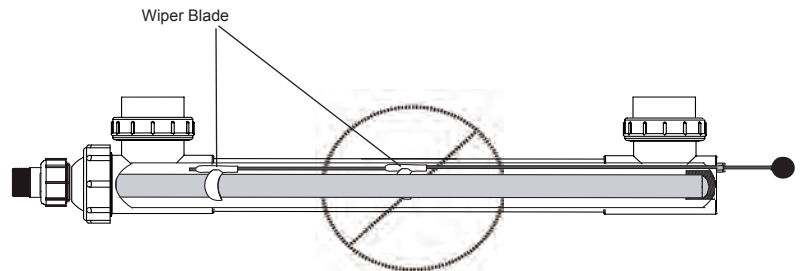

Incorrect: Quartz Sleeve Not Seated
See Page 24 for Proper Quartz Sleeve installation

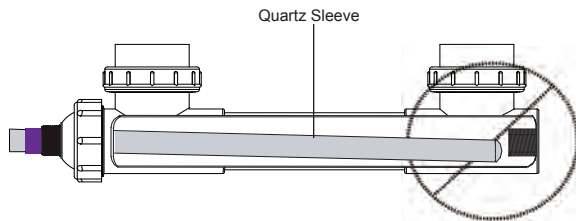

Lamp Dropped in Quartz Sleeve can Cause Breakage

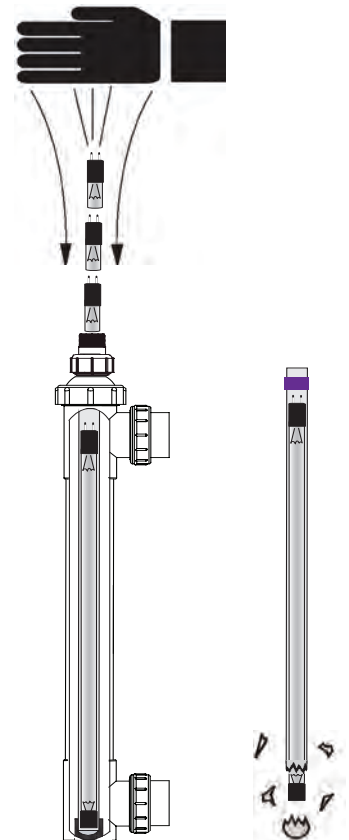

Incorrect: Lamp at an Angle will create a U Shaped Crack
See Page 17 for Proper Lamp installation

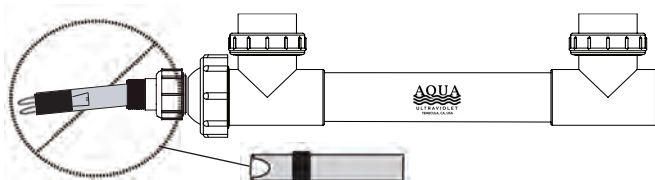

Incorrect: Lamp Not Plugged Flush with Lamp End Connector
See Page 17 for Proper Lamp installation

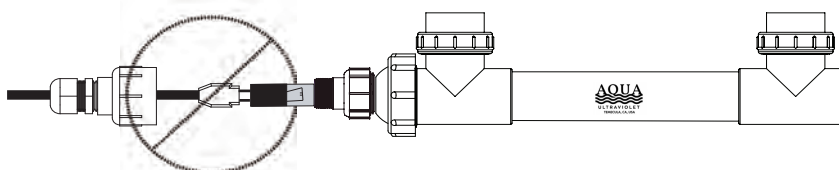



EPA Est 68177-CA-001

MAILING ADDRESS

PO Box 2189
Temecula, CA 92593

MAIN OFFICE

42371 Avenida Alvarado
Temecula, CA 92590
Toll Free: (800) 454-2725
Tel: (951) 296-3480
www.aquauv.com