

Performance

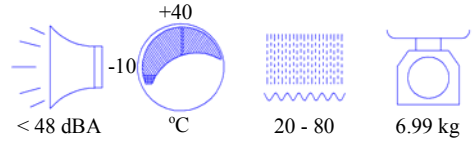

★ Allowance :  $\pm 5\%$

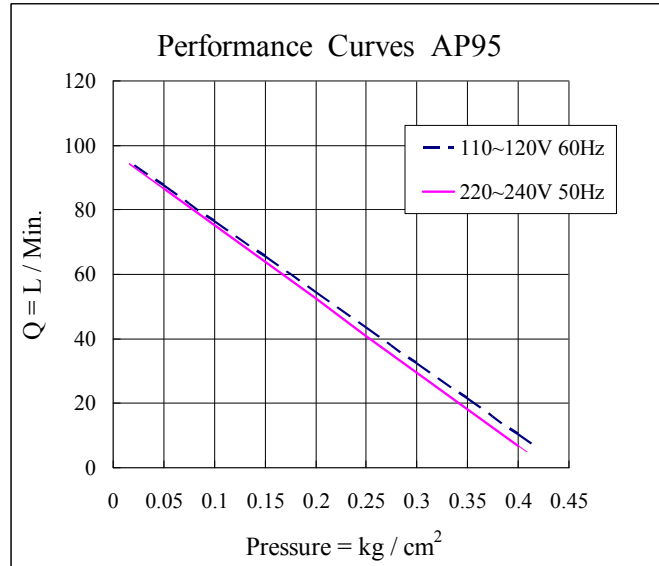

**Exhaust**

Dimensions

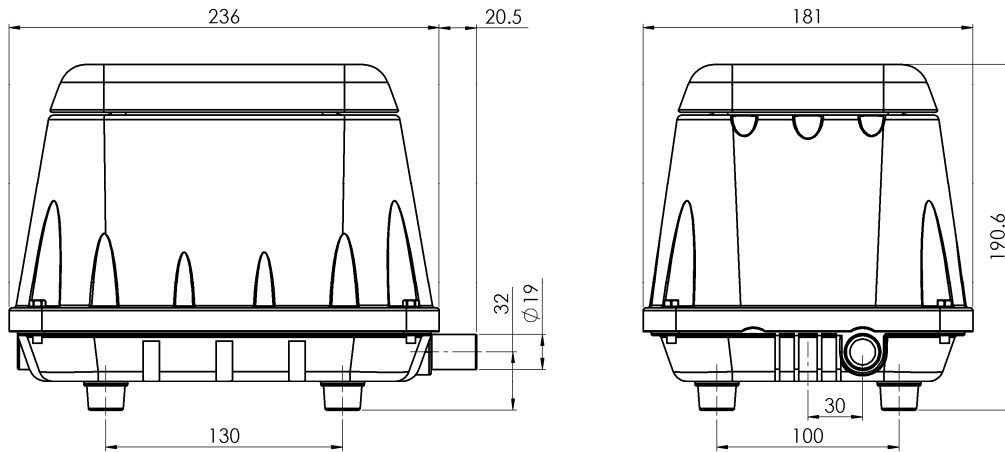

**Operating range : 0.1 to 0.25 kg/cm<sup>2</sup>**

Model No.	Voltage (VAC)	Frequency (HZ)	Rated Pressure (kg/cm <sup>2</sup> )	Airflow (LPM)	AMP (A)	WATT (W)
AirPump 95	110 ~ 120	60	0.15	68	1.3	63
AirPump 95	220 ~ 240	50	0.15	66	0.6	61