

YOSUDA Treadmill-S100A Manual

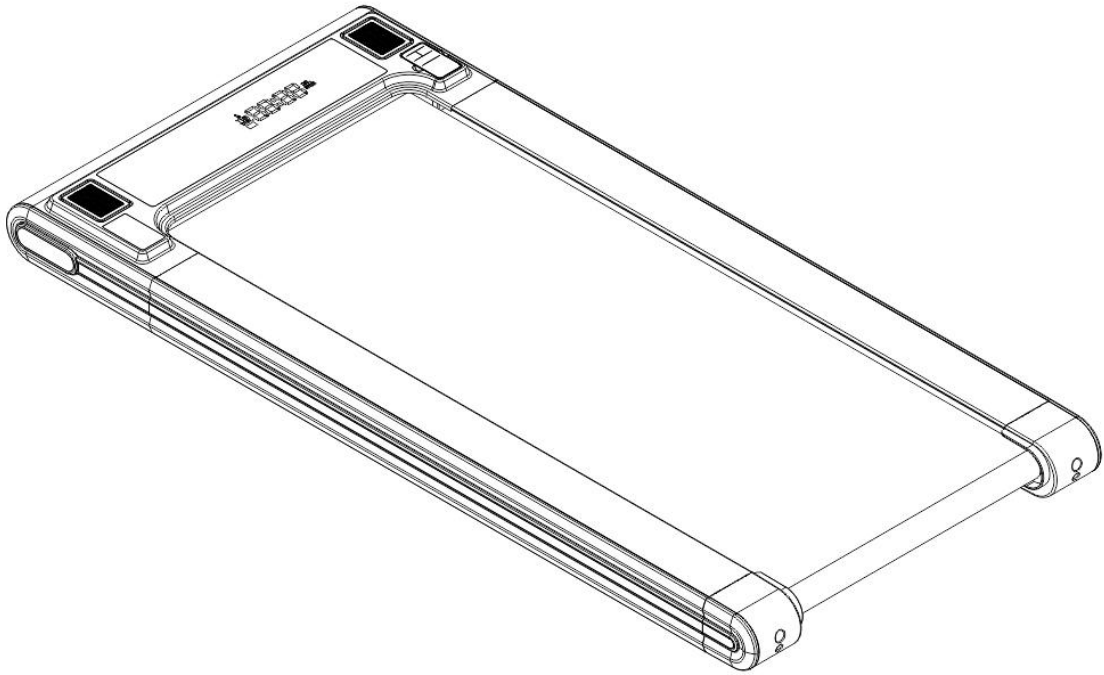

IMPORTANT! Please read this manual before assembling and using. Retain owner's manual for using instructions. Your satisfaction is very important to us, any questions **PLEASE CONTACT US.**

Catalog

Important Safety Instructions.....	1
Warranty Commitment.....	2
Parts List and Technical Parameters.....	3
Product Structure.....	4
Assembly Instructions.....	5
Function Operation Instructions.....	6
Warm-Up.....	8
Maintenance Guide.....	9
Trouble Code.....	12

Customer Service

Please let us know if you have any issues or concerns with the transaction, shipping or product. And relevant photos or video are very important to help us better understand the problem. We'll do our best to make it right for you!

➤ **Contact us via Amazon: Login your amazon account**

> **choose "Your orders"**

> **find the order ID**

> **click "Contact seller"**

Or

➤ **Click our store "Seller name" Under the Buy Box**

> **Click "Ask a question"**

> **Click "An order I placed"**

> **Select a subject and write a message to us**

Thank you for purchasing our products. Our products will help to improve your health

Treadmill supports connecting to mobile App via Bluetooth

(Note: The scenario simulation function in the FITSHOW ,KINOMAP& ZWIFT APP is free for a limited time. The final right of interpretation belongs to the official FITSHOW , KINOMAP& ZWIFT APP.)

FITSHOW

1. Scan this QR code and download app
2. Open the app and register the personal information.Turn on our phone Bluetooth.
3. Click the “Running”, and then click the “Quick Start” button, the program is connecting to the machine, wait until the mobile phone program displays the word connection, and click the connection directly.



Note:In order to ensure correct and fast connection, it is necessary to turn on the treadmill connection power in advance and turn on the Bluetooth on the mobile phone.

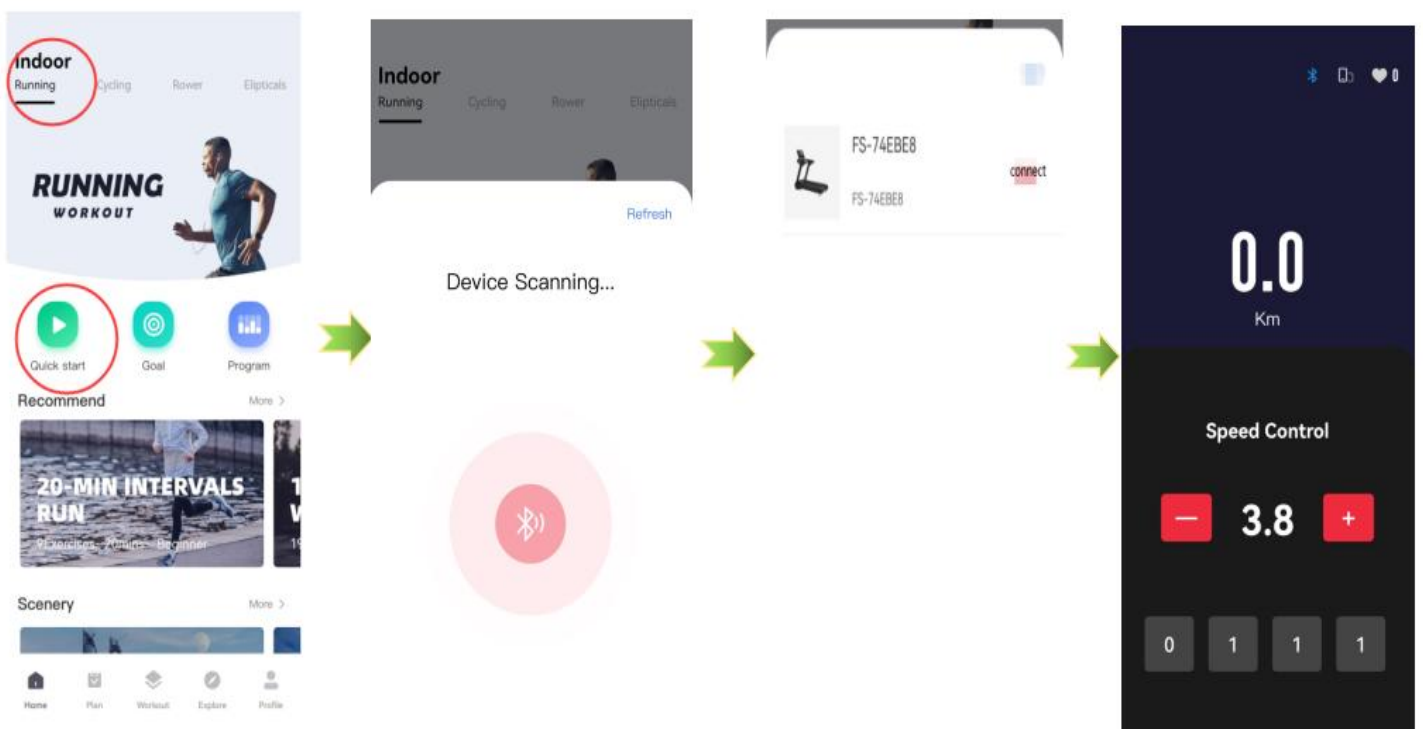

Kinomap

Search "KINOMAP" in the mobile app store to download app and register the personal information.

Note: The treadmill can connect to FTMS and XG FITNESS.

Our Bluetooth and treadmill equipment must be turned on to connect.

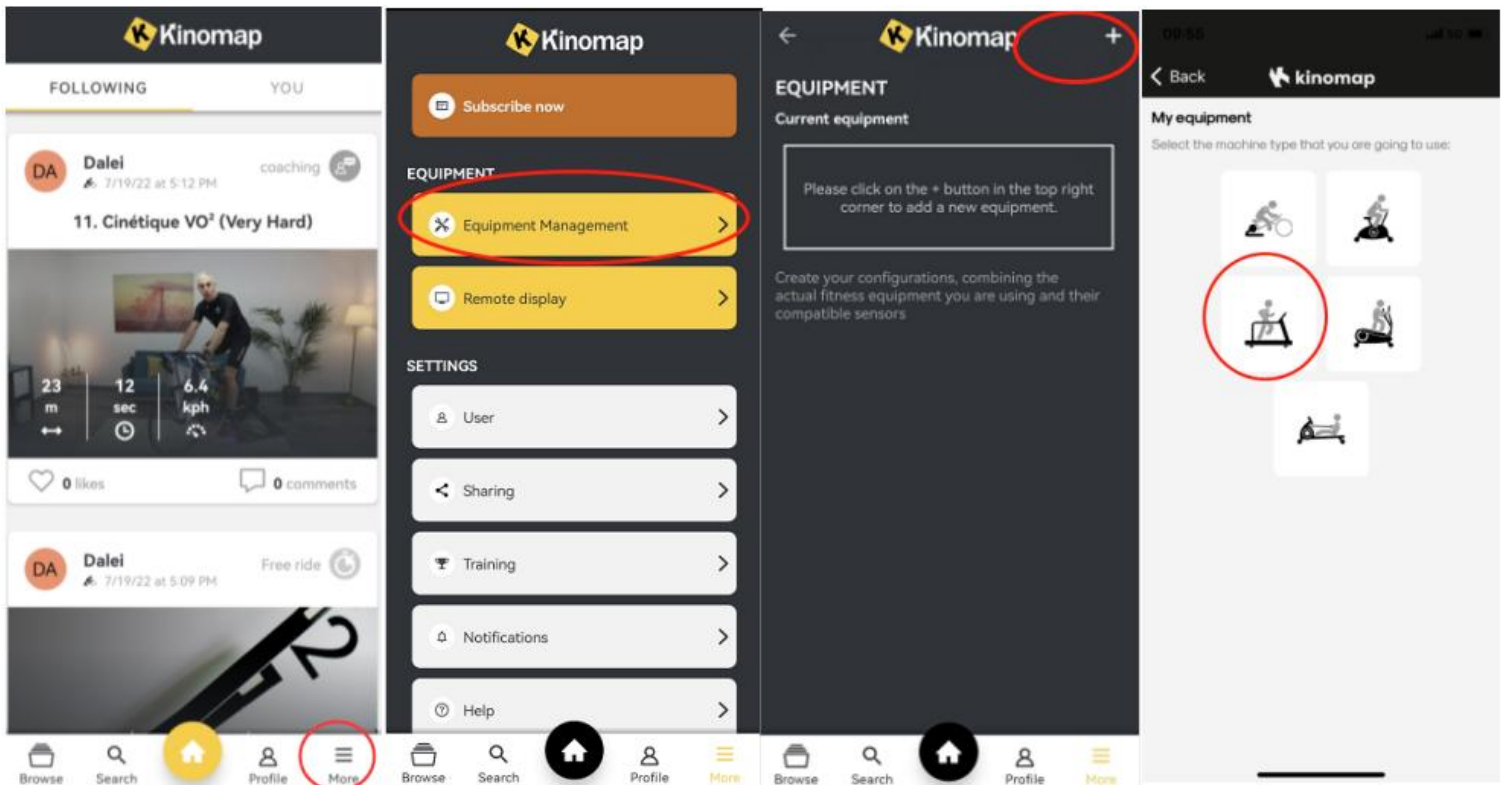

There are two ways to connect to the treadmill via Bluetooth. If one of **XG FITNESS** and **FTMS** cannot be connected, please change to another mode.

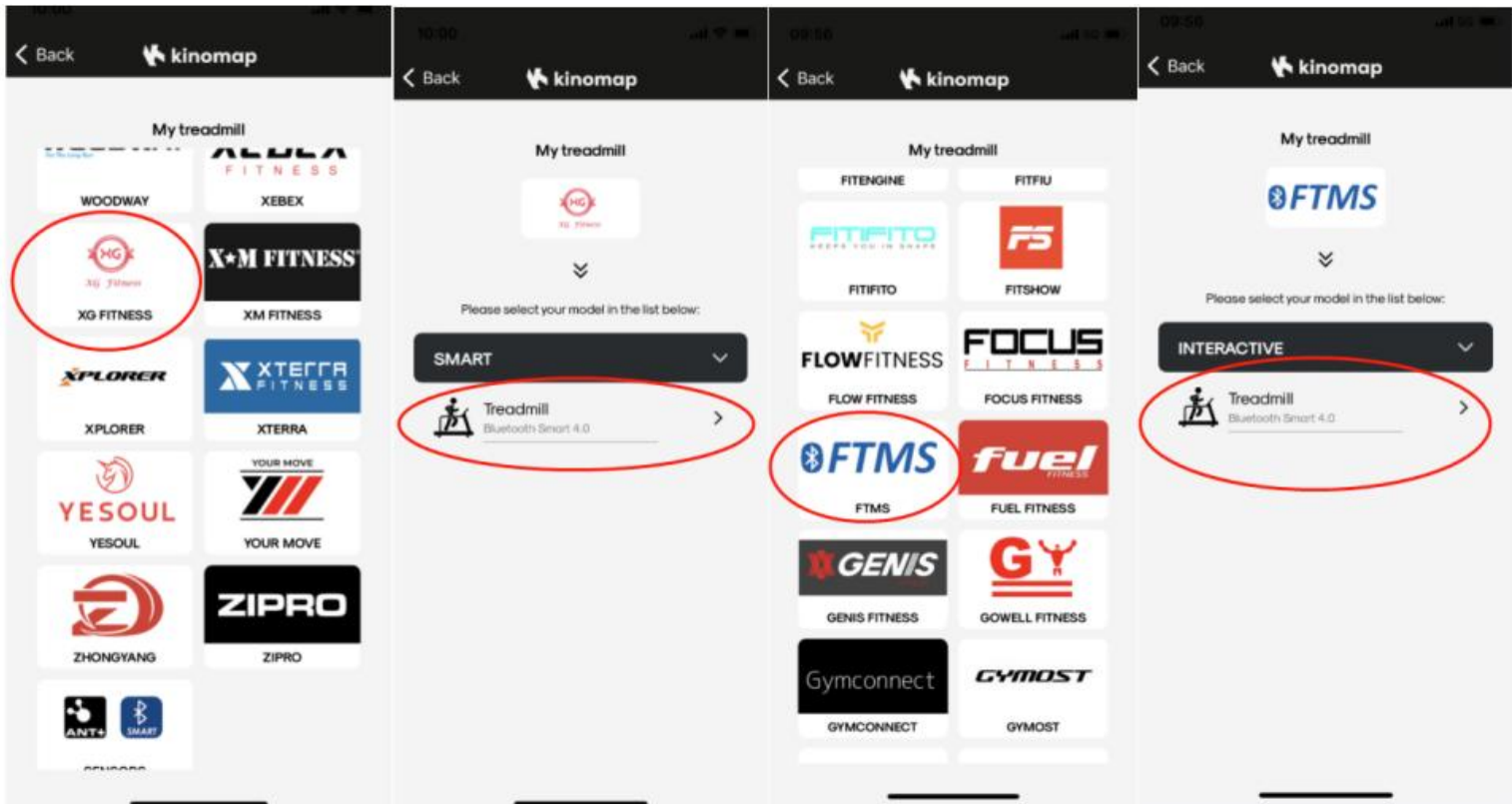

Finally, the connection is successful, and the user interface display is as follows.

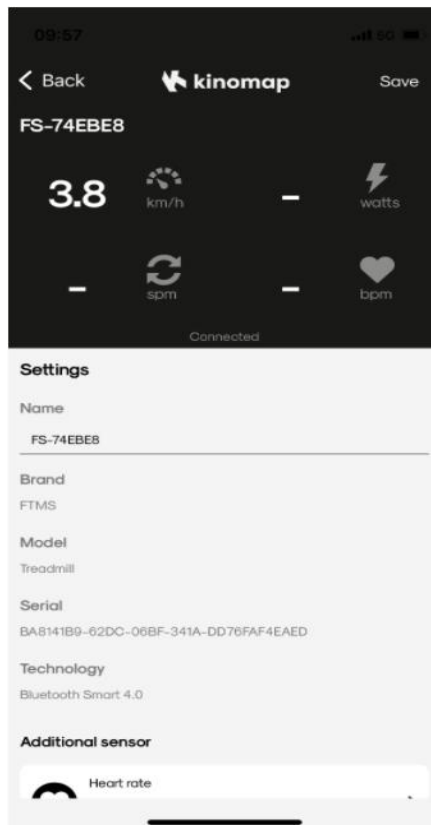

Zwift

【1】 Search "ZWIFT" in the mobile app store to download app and register the personal information.

【2】 Choose to pair running equipment;

【3】 After the pairing is successful, click OK to start exercising;

【4】 The treadmill needs to press the start button on the device to start exercising;



Note: The Bluetooth model connected to the APP is not unique, and the specific model is based on the model displayed on the mobile phone connection.

Important Safety Instructions



To ensure your safety and to avoid accidents, please read the operating instructions carefully before use.

- This product is an indoor household appliance, please do not modify it for other purposes or use it outdoors; the location of the treadmill should be flat and clean, and do not place it on for thick carpets or near water, there should be a barrier-free safety area of 1000*1000mm behind the treadmill and 500mm on the left and right sides.
- This product is for adults, and minors need to be accompanied by adults. Physically uncomfortable or mentally handicapped and those who lack common sense prohibited use. unless they have been under the supervision or instruction regarding the use of the product by a person responsible for its safety.
- If the power cord is damaged, it must be replaced by the manufacturer or professional maintenance personnel in order to avoid hazards.
- This product is only used for 100V—120VAC voltage. Please use a power outlet with safety grounding, grounding plug installation and grounding matters Be sure to be consistent with the parameters of the user's area. If the plug and socket are not compatible, please arrange a qualified electrician or after-sales personnel to come deal with.
- Please check all parts before use to ensure that the screws and nuts are locked tightly.
- Please wear comfortable tight clothes when using to avoid clothes being caught by the machine. Keep small children or pets away to avoid accidents.
- Keep your hands clear of all moving parts, and do not put your hands and feet in the space under the running belt.
- This product is suitable for home use, not for professional training and testing, nor for medical purposes.

- The heart rate display of this product does not provide data for clinical medicine.
- This product is for one person use only when it is in operation.
- Please switch off and unplug before cleaning and maintenance;
- Please turn off the phone and unplug it when people leave.
- Please use the accessories provided by the original factory,and unauthorized replacement is strictly prohibited.
- This product is HC grade, the maximum weight of the user is **265LBS**.

Warranty Commitment

We make sure that this product is made of high quality material.

Under normal use, if something goes wrong, we will be responsible for the warranty.

The warranty period is 1 year (from the date of purchase). If the product you purchased has quality problems, please contact our customer service within 12 months. Please do not deal with it without permission.

The following conditions are not covered by the warranty:

- Damage caused by external causes.
- Non-original accessories are used.
- Incorrect handling by oneself.
- Failure to follow instructions.

This warranty commitment is only valid for private use at home, not for professional training situations such as gyms.

If you need to purchase non-warranty accessories, please contact customer





service. Please provide the following information when ordering:

- Manual.
- Product model.
- The serial number of the accessory.
- Proof of date of purchase. (Amazon order invoice)

Please do not send the product to our company without the confirmation of our company's customer service. If you send the product back without permission, our company will not bear any costs.

Parts List and Technical Parameters

Machine configuration

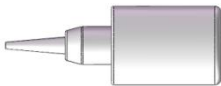
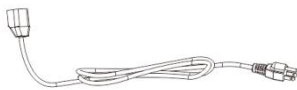
Name	Sketch (for reference)	Qty
Treadmill		1
remote control		1
manual		1
Allen wrench		1
lubricant		1
Power cable		1

Technical specifications

product configuration	specifications
Package size	54*27*5.5in
Product size	49*24*5in
Running Area Size	42.7*17in
Rated power	550W
Speed	0.6-4.0MPH
Weigh Capacity	265 lbs
N.W/G.W	53/ 59.5lbs

Product structure

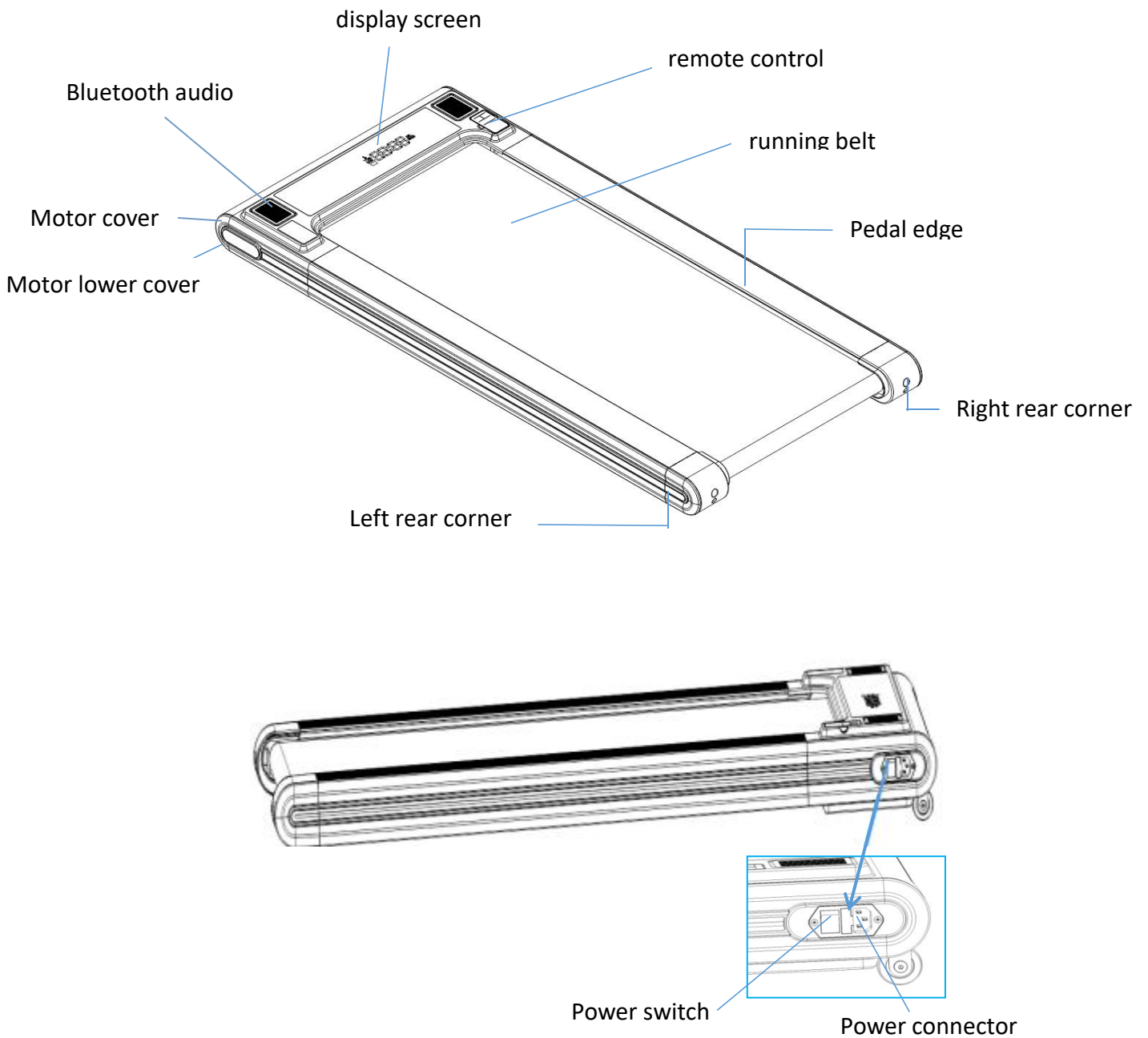

Assembly Instructions

Step 1: Open the packing box, remove the relevant accessories and machine from the box, and place the machine on flat floor.

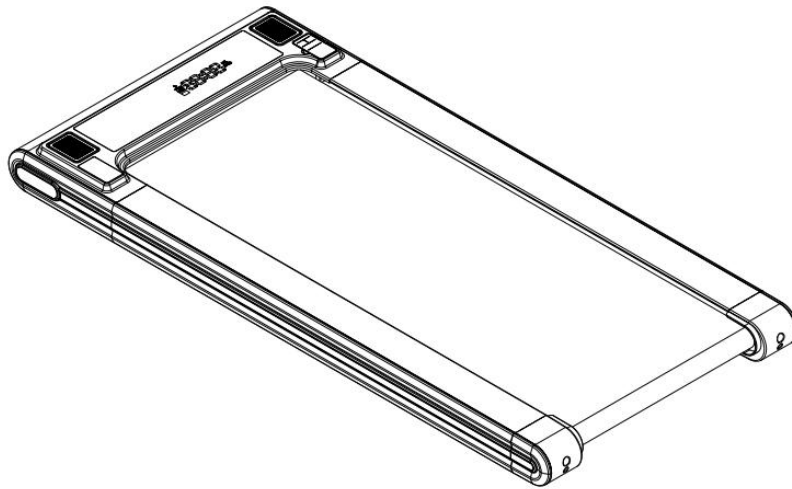

Step 2: Connect the power cable, and turn on the power switch to complete the assembly.

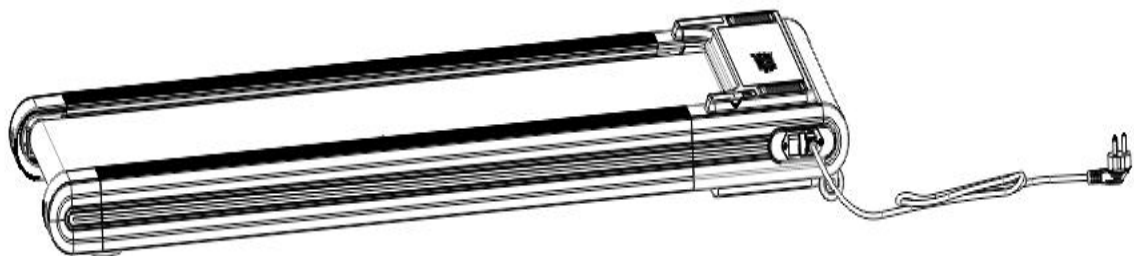

Function Operation Instructions

Start-up instructions

Turn on the power supply, turn on the power switch and the machine will enter the standby state quickly; the remote control will start the machine at 0.6MPH.

Display screen instructions

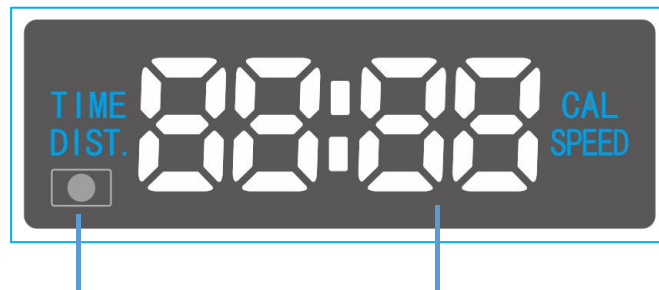

Infrared receiver

Function display: speed, calories, time, distance.

Infrared receiving: When using the remote control product to operate, the remote control needs to be aimed at this position.

Function display: SPEED display when adjusting the speed operation, the speed parameters are displayed at this time; SPEED, CAL, TIME, DIST. are displayed in a cycle every 3 seconds respectively when the machine is running without operation.

Description of the remote control key functions

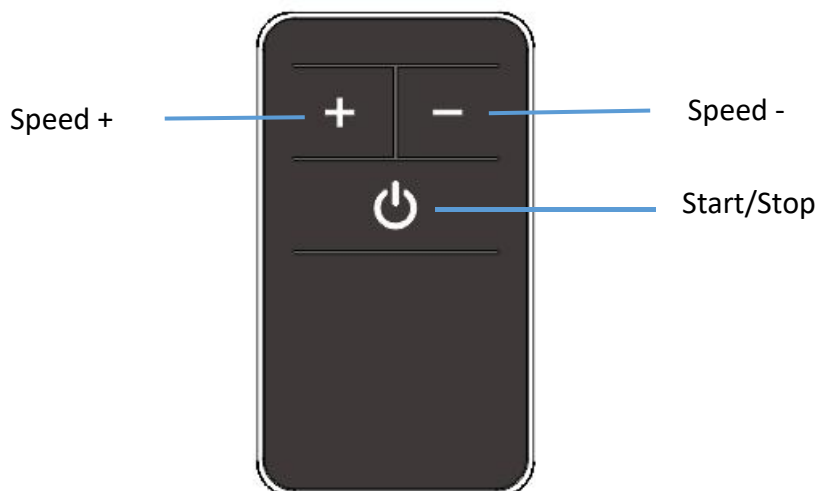

Operating Instructions

Functions:

1. Press key to start/stop, speed +/- .
2. Speed display 0.6-4.0MPH, Calorie display 0001-9999KCAL, Time display 01:00-99min
3. Display changes function menu (time, speed, distance, calories) every 3 seconds during operation.
4. Automatic stop at 99.00 minutes.
5. After 5 minutes of no operation after shutdown, it enters into a dormant state, and the display screen goes off.

Speed control instructions

Each press of the speed+ button on the keypad or rocker during operation increases the speed by 0.2MPH, a long press of the speed+ button increases the speed by 0.2MPH continuously.

Each time you press the speed-button on the keyboard or remote controller during operation, the speed will decrease by 0.2MPH; press and hold the speed-button to continuously decrease at a speed of 0.2MPH.

Note: During speed operation, the display shows speed data, and if the speed is not adjusted within 3 seconds, the display will cycle through the function menus (time, speed, distance, calories) every 3 seconds.

Stopping instructions

In the running state, press the stop button on the remote control, the machine stops running slowly.

Warm-Up

Before exercising, it is best to do stretching exercises. A successful exercise program must include warm-up, aerobic and soothing exercises. The amount of exercise should be carried out at least two to three times a week, with one day off for one day of exercise. After a few months, you can increase the amount of exercise to four to five days a week.

Warming up is a very important part of your fitness exercise. Warm up before each exercise. Moderate warming up can prepare your body for more intense exercise, because warming up can help muscles warm up and stretch, Improves blood circulation and pulse rate, sending more oxygen to the muscles. After aerobic exercise, repeated warm-up exercises can also reduce muscle soreness. We recommend the following warm-up and cool-down exercises.

1.Stretch down

The knees are slightly curved, the body slowly bends forward, let the back and shoulders relax, and the hands try to touch the toes.Keep it for 10~15 seconds, then relax. Repeat 3 times (As picture 1 shown).



2. Tendon stretching

Sit on a clean seat cushion and straighten one leg. Put the other leg inward so that it fits snugly against the inside of the straight leg. Try to touch the toes with your hands. Keep it for 10~15 seconds, then relax. Repeat 3 times for each leg.(As picture 2 shown).



3. Calf and heel stretch

Hold the wall or tree with both hands and one foot behind. Keep your hind legs upright and your heels on the ground, leaning in the direction of the wall or tree. Keep it for 10~15 seconds, then relax. Repeat 3 times for each leg. (As picture 3 shown)



4. Head exercises

Tilt your head to the right for a count of one ,and feel the stretch in the left stretching of the neck muscles;then turn your head to the back for a count of two.Then turn your head to the left for a count of three; finally turn your head turn your head back down towards your chest for a count of four. Then relax and repeat for 3 times.(As picture 4 shown)



5.Waist exercise

Stretch your arms to the left and right and then slowly raise them slowly above your head. Hold your right arm as straight as possible towards the ceiling. Hold for 1 second and feel the stretch in your right side. Repeat with your left arm.(As picture 5 shown)



Maintenance Guide

 **Warning:** Always unplug the treadmill from the power supply before servicing the product.

- Use a cloth to clean the surface of the product.
- Thorough cleaning will extend the life of the machine.
- A thorough cleaning will extend the life of the machine.
- Regularly remove dust to keep the parts clean and sweep the exposed parts of the running belt on both sides, which will reduce the accumulation of impurities on the running belt. Keep the sneakers clean to avoid carrying foreign objects under the running belt and wearing the running board and belt. The surface of the treadmill must be cleaned with a soapy damp cloth. Be careful not to splash water on the electrical components and under the treadmill.
- Check and lock all parts of the treadmill frequently, replace those defective parts and/or leave the equipment unused until restoration.

1. Adjust the running belt

If you are using the treadmill, the running belt slippage or not smooth, you can adjust the running belt elasticity to improve.

There are two functions for running adjustment: tightness adjustment and running belt center position adjustment. The running belt has been adjusted at the factory, but after use, the running belt will be stretched, and it will deviate from the center position, causing the running belt to rub against the pedal edge and the rear cover and damage it. It is normal for the running belt to stretch during use.

When the product is running at no load, the running belt will have a side deviation of not more than 5mm is a normal phenomenon.

Adjustment of the running belt method (the picture is for reference only, subject to the real thing)

◆ The running belt deviates to the left

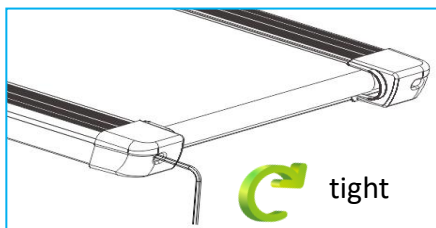

Adjustment method: When the power is turned off, take a 5mm hexagonal wrench, turn the adjusting bolts on the left side $\frac{1}{4}$ turn clockwise, and then power on the machine to run, and the test running belt is centered. Proceed in this way until the loose adjustment of the walking belt is centered.

◆ **The running belt deviates to the right**

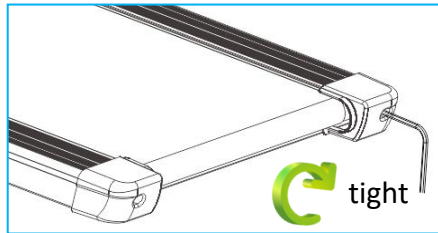

Adjustment method: When the power is turned off, take a 5mm hexagonal wrench, turn the adjusting bolts on the left side $\frac{1}{4}$ turn clockwise, and then power on the machine to run, and the test running belt is centered. Proceed in this way until the loose adjustment of the walking belt is centered.

◆ **The running belt will be loose after using for a period of time, the running belt is too loose, the running belt will slip when using.**

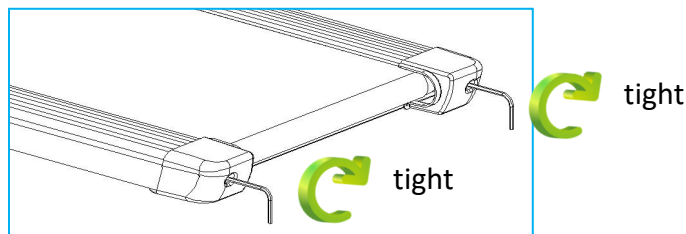

Adjustment: In the state of power off, take a 5mm hexagonal wrench, turn the left and right bolts of the rear roller to the right $\frac{1}{4}$ turn at the same time to tighten the running belt, and then power on the machine to run and test the tightness of the running belt. This method until the running belt tightness is appropriate.

Note: When you use the treadmill, due to the running of the two feet with the same force is not as large, the pressure on the running belt is not balanced, resulting in the running belt deviated from the center. This deviation is normal, when no one is running on the running belt, it will return to the center. The running belt should not be adjusted too tightly. This will pull the running belt, increase the pressure on the front/rear drums, bring harm to the drum bearings, etc., and produce noise or other problems.

2. Lubricating oil for walking machine

The machine is pre-lubricated before leaving the factory. With use, the belt running deck will become dry gradually and the friction between the belt and deck will increase, which may wear both the deck and the belt. Proper belt lubrication will help keeping your treadmill in its best condition. We recommend you to lubricate your treadmill once every 30 hours in use.

Note: Please use special lubricants for treadmills or contact our company directly.

How to add lubricant to the treadmill:

- Turn off the power switch and unplug the power plug. The place to lubricate is on the lower surface in the middle of the running belt. (As shown below)
- Cut the mouth of the oil bottle into a small mouth, not too large, but to be able to inject.
- Lift the running belt so that the oil bottle is extended to the bottom of the running belt, inject the oil into the middle of the running board, and lower the running belt.
- Plug in the power plug and turn on the power switch. After turning on the machine, wait one minute for the oil to be applied evenly and then use the treadmills.

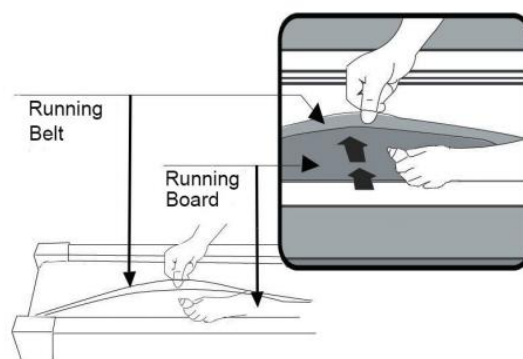

Note: Attention should be paid to safety during lubricating operations.

Trouble Code

Code	Causes	Resolutions
E01	Poor communication between electronic meter and controller	<ol style="list-style-type: none"> 1. Check that the connection between the electronic meter and the controller is not properly connected. 2. The main IC of the controller contacts badly and is re-tightened. 3. Controller power supply abnormal, change controller
E02	Explosion-proof and impact-proof protection	<ol style="list-style-type: none"> 1.If the motor is open or in bad contact, replace the motor or check the connecting terminals. 2.Power tube breakdown, replace it or the controller.
E05	Over current protection	<ol style="list-style-type: none"> 1.Overload. 2.The resistance of the treadmill is too heavy and needs to be lubricated. 3.The motor is damaged, replace it.
E06	Overload protection	
E10	Keyboard and panel control connection communication failure	<ol style="list-style-type: none"> 1. Check if the connection between the electronic watch and the controller is poorly connected. 2. The controller plug is not in good contact and is re-inserted. 3. The controller power supply is abnormal and the controller is replaced.