

PORTABLE POWER STATION

MASTER 2200

USER MANUAL

■ SAFETY INSTRUCTIONS

IMPORTANT SAFETY INFORMATION

To ensure safe operation and service of the power station, read and understand all instructions. Failure to follow all instructions may result in severe injury or property damage. The loss caused by wrong use of POWER STATION is not covered by our Warranty.

CHARGE NOW

Please FULLY charge the POWER STATION as soon as possible once you have it in possession.

Due to the length of time spent in transit and storage, the batteries may be reduced or in sleep mode.

Plug in the POWER STATION into a wall outlet for 10 minutes to reactivate the battery. If it doesn't charge after 10 minutes, please contact customer service team.

Note:

When turning on the AC Button, the LCD Display may show watts being drawn before you have plugged into a wall outlet. This is normal response caused by the "no-load" discharge. It is recommended that you turn off the output button(s) when not in use.

■ FEATURE DETAILS

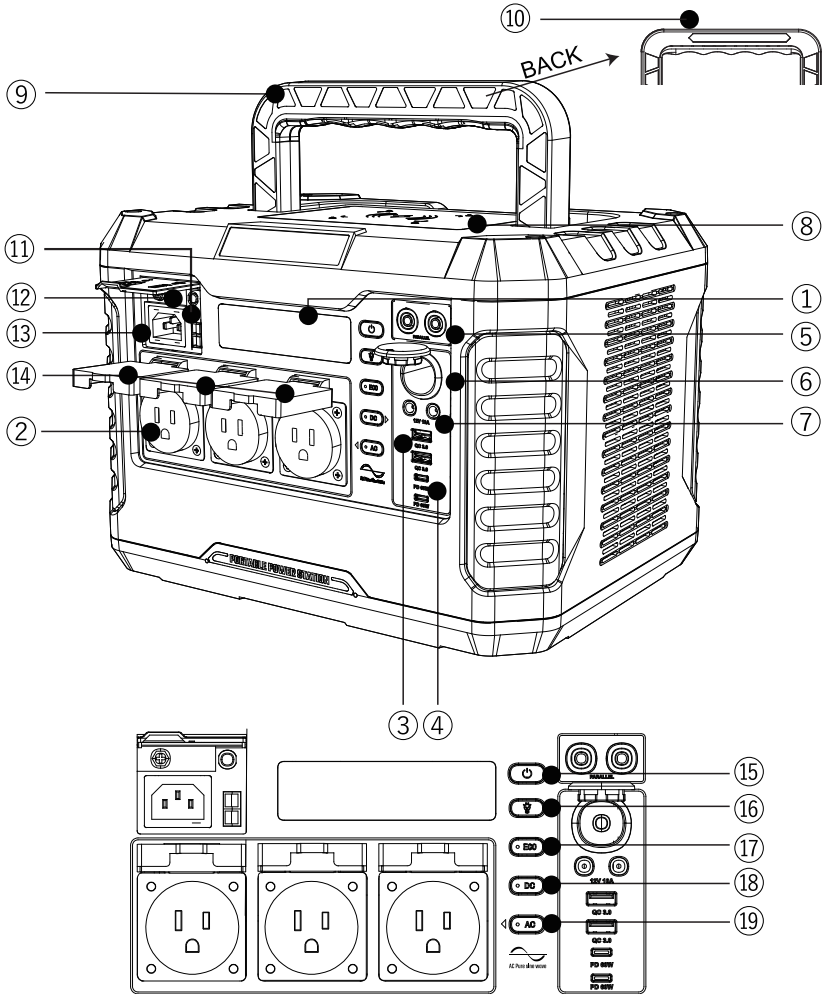

- | | | |
|--|-----------------------------|-----------------------------|
| 1. LCD Screen Display | 2. AC Outlet | 3. USB QC3.0 |
| 4. USB-PD | 5. Parallel Connection Port | 6. Cigarette Lighter Output |
| 7. DC 5525 | 8. Wireless Charger | 9. Handle |
| 10. LED Light | 11. Anderson Input | 12. Reset Button |
| 13. AC Input | | |
| 15. Power ON/OFF Button | | |
| 16. LED Light (SOS) ON/OFF Button | | |
| 17. ECO Function ON/OFF Button | | |
| 18. DC/USB Outputs Power ON/OFF Button | | |
| 19. AC Outlet Power ON/OFF Button | | |

■ OPERATION GUIDE

FUNCTION BUTTONS

15: 

Power ON/OFF Button

18: 

DC/USB Outputs Power ON/OFF Button

16: 

LED LIGHT ON/OFF Button

19: 

AC Outlet Power ON/OFF Button

17: 

ECO Function ON/OFF Button

15: POWER ON/OFF Button

POWER ON/OFF BUTTON is the master switch. Press POWER ON/OFF BUTTON to activate the DC/AC/ECO BUTTONS.

16: LED LIGHT ON/OFF Button

Press LED LIGHT ON/OFF Button once to turn on the LED LIGHT, press it again to turn off the LED LIGHT.

Press LED LIGHT ON/OFF Button over 3 seconds to turn on the SOS mode.

17: ECO Function ON/OFF Button

ECO Mode: If the output ports are not in use, the power station will automatically turn off after 1 hour for power saving.

Press the POWER ON/OFF Button, ECO Mode will be activated by default. If you do not need this function, please press the ECO ON/OFF Button to turn it off. The ECO mode will NOT Function until the ECO Button is on to activate again.

18: DC/USB Outputs Power ON/OFF Button

The DC/USB output ports will Not Function until the DC OUTPUT POWER ON/OFF BUTTON is pressed to activate.

19: AC Outlet Power ON/OFF Button

The AC Outlet will NOT function until the AC Outlet Power ON/OFF Button is pressed to activate.

Parallel mode: Press the AC Outlet Power ON/OFF Button over 3 seconds to turn on the parallel mode when two power stations can parallel together. Press the AC Outlet Power ON/OFF Button over 3 seconds again to turn off the parallel mode.

WIRELESS CHARGER

Press ON/OFF Button before charging. Press the ON/OFF Button to shut down the output.

■ OPERATION GUIDE

LCD FEATURES

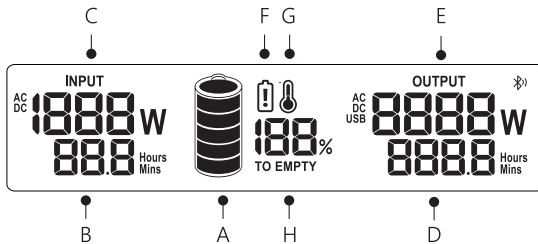

- A:** Battery Level **B:** Remaining Charging Time **C:** Input Power
D: Remaining Usage Time **E:** Output Power **F:** Low Voltage Warning
G: Temperature Warning **H:** Low Battery Alarm

DETAILS DISPLAYED ON LCD

Battery Level: The battery level is provided by the percentage of battery charge corresponding to the number of bars and percentage displayed.

PLEASE BE AWARE that this value can adjust multiple times as the energy draw changes from the connected devices. This is evident during the initial activation of ports with a connected device.

RECOMMENDED charge the **POWER STATION** when battery indicates less than 20%. Note that when you first plug into a power source, whether a solar panel or a wall charger, the **POWER STATION** may take a couple of minutes to detect and adjust its charge circuitry before it starts to draw power.

Remaining Charging Time: The **POWER STATION** can provide remaining charging time in hours and minutes.

Input Power: The **POWER STATION** can provide input energy in watts.

Remaining Usage Time: The **POWER STATION** can provide remaining usage time in hours and minutes.

Output Power: The display will provide the total output watts of the Cigarette Lighter Port, USB-A, USB-C and AC Outlet(s). When the AC Outlet Power ON/OFF Button is pressed activated, the AC on the screen will light up. When in parallel mode, the AC will twinkle every second.

Low Voltage Warning: If the Low Voltage Warning indicator is on, please recharge the power station.

Temperature Indicator: The Temperature Indicator lights on means the battery temperature of **POWER STATION** is too low/high. All functions of input and output will be stopped until the battery temperature returns to the working range.

Low Battery Alarm: The "TO EMPTY" Light on means the battery is lower than 20% and you should charge it as soon as possible to make the battery lifetime service longer.

■ Additional Function

UPS MODE

When connecting the AC charging cable to the main supply and charging devices to Master with AC ON, it would not consume the battery of Master. When power outage happens, it automatically switch charging from the main supply to stored battery within 10m milliseconds.

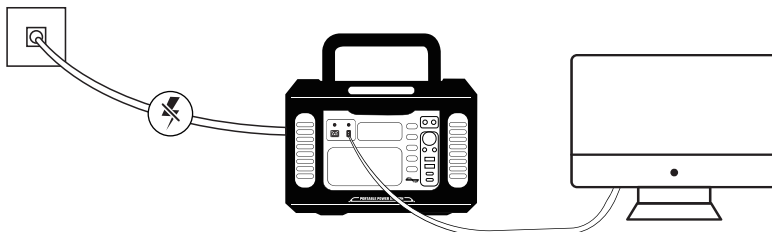

NOTICES:

Since there is 10ms switching time after power outage, some devices with switches need to be manually restarted .

UPS mode is not applicable to DC/USB output.

WOULD NOT be functional when paralleling two power stations.

ONLY WORKS when AC ON/OFF BUTTON is ON.

When charging and using the power station at the same time, it is powered directly by AC input.

Since the input current is limited to 15A, the total power of input and output is less than or equal to $15A \times \text{voltage}$.

Parallel Connection Kit (sold separately)

Plug the DC port of the parallel box separately into the two same power stations as below to expand the power watts.

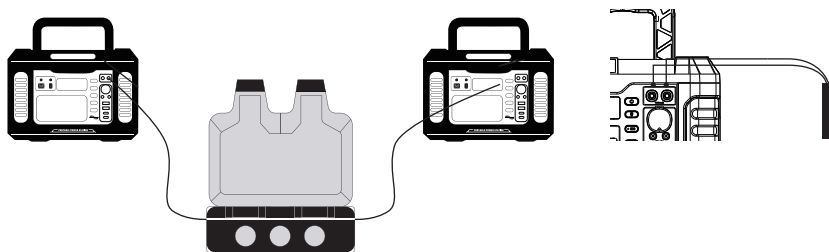

NOTICES:

The red part of the DC plug is positive, and the black part is negative.

Please connect the positive to positive and the negative to negative to ensure using correctly.

Please connect the parallel cable first, then press the AC output button to activate the parallel function.

The total output watts are separately displayed in the LCD of power station.

UPS WOULD NOT be functional when paralleling two power stations.

Please parallel two same power station with the provided parallel box (sold separately).

■ GENERAL SPECIFICATIONS

Model	MASTER 2200
Battery	Lithium Battery
Capacity	1944Wh (43.2V, 45Ah)
Dimensions	L350 x W265 x H240 mm
Weight	32.8 lbs(14.9kg)
Charging Temperature	32 to 104°F (0 to 40°C)
Discharging Temperature	14 to 104°F (-10 to 40°C)
AC Input	120V~60Hz 1000W Max
Solar Input	12-60V== 800W Max
AC Outlet	3x 120V~60Hz 2200W, 4400W surge
DC Ports	2x 12V==10A (DC5525), 1x 12V==10A(Cigarette Lighter Port)
USB-A Ports	2x 5V==3.4A、9V==2A、12V==1.5A, total 36W Max
USB-C Port	2x 5V==3A,9V==3A,12V==3A,15V==3A,20V==3A, total 120W Max
Wireless Charger	1x 10W
LED Lighting (SOS mode)	1x 1W

ACCESSORIES

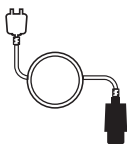

• AC Cable

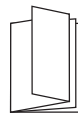

• User Manual

NOTICES:

- Check the input charge cable. The ports will be efficient when the input charge cable meets the specification outlined in the GENERAL SPECIFICATIONS section.
- Only charge POWER STATION with provided AC cable.

■ OPERATION GUIDE

HOW TO CHARGE

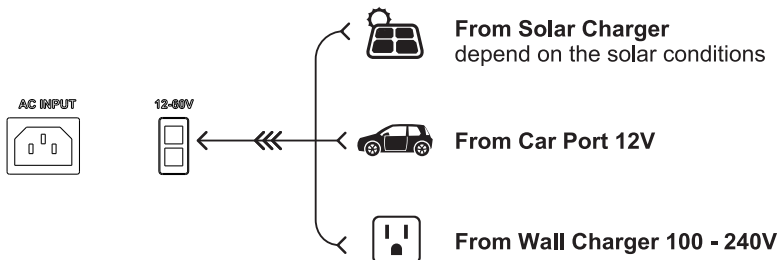

RECOMMEND TO DISCONNECT THE POWER STATION WHEN IT FULLY CHARGED.
WHEN CANNOT CHARGE THE POWER STATION, PLEASE CHECK IF THE RESET
BUTTON IS ON.

POWERING / CHARGING DEVICES

Select the type of output required by pressing either the DC (DC/USB outputs), AC, or ECO outlet button. The ports will NOT function until the appropriate button(s) are pressed to activate the port. When the ports are activated, the indicator on the button will illuminate green, indicating that the output(s) are active. The LCD screen will turn on and provide details on the output watt.

Press the ON/OFF BUTTON(s) to shut down the output(s) when not in use.

PASS-THROUGH CHARGING

The advanced battery management system of the POWER STATION allows it to charge a connected device via DC outputs & USB outputs & AC output while charging the POWER STATION.

OVERLOAD CONDITION

If an overload condition occurs on the OUTPUT ports, POWER STATION will:

Automatically turn off the outlet's power.

- The indicator light of the LCD Screen will still be illuminated.
- The DC Output's status will still be the same status as usual.

OPERATING INSTRUCTIONS

CHARGING POWER STATION

When charging, the LCD will show battery level. POWER STATION is fully charged when it shows 100%.

It is recommended to FULLY charge POWER STATION every 3 months to maintain the health of the battery pack.

■ MAINTENANCE

MAINTENANCE

Recharge as needed. There are no pre-designated intervals at which to recharge as long as the POWER STATION is being used regularly. Avoid fully draining the battery to 0%, as this can impact the quality and life span of the battery. Periodically inspect all ports and wall chargers for any debris, dirt, damage, and corrosion. DO NOT attempt to fix it. DO NOT cover the POWER STATION with towels, clothing, or other items. Regularly inspect the side vents to make sure there is no dirt or dust. If there is debris, clean the unit following the cleaning procedures noted in the manual.

CLEANING

Be sure that POWER STATION is disconnected from all input power sources and output devices. Use a clean, dry, soft lint-free cloth to wipe it down. Remove any debris, dirt, or other blockages on both side vents. When cleaning debris from the side vents, do not allow the debris, dirt, or other blockages to enter the body of POWER STATION.

DO NOT use abrasive cleaners or solvents.

DO NOT use compressed air to clean side cooling vents.

To avoid the risk of electrical shock, DO NOT use metal objects to clean the ports.

STORAGE

If storing for more than 1 month, charge it completely before storing it. Recharge the unit approximately every 3 months to avoid full discharge and possible damage. Store indoors in cool temperatures with only mild humidity, and away from direct sunlight (See GENERAL SPECIFICATIONS section). Leaving the unit in a vehicle or other confined spaces in extremely hot temperatures would lead to decrease the service life, cause overheating, and even fires. Extreme cold temperatures can harm the POWER STATION performance and service life. Keep away from corrosive chemicals and gases. After taking the unit out of storage, inspect the unit and make sure all the accessories look satisfactory. Review the intake and the exhaust side vents to ensure they are clear of debris. Allow the POWER STATION to return to safe ambient conditions before recharging or charging other devices.

DISPOSAL/RECYCLE

Do not place the unit or its accessories in the trash. These items must be appropriately disposed of in accordance with local regulations. See your local government's laws for additional information.

■ TROUBLESHOOTING

Indicator	Phenomenon	Solutions
E1	AC Output Overload Warning	Please charge/power the devices within the rated power. Otherwise, the AC button will automatically turn off.
E2	AC Output Off	Please charge/power the devices within the rated power. And then push the AC button to restart.
E3	DC Output Overvoltage / Undervoltage	Please charge/power the devices within the rated Voltage of DC and then press the ON/OFF Button to resume the functions.
E7	DC Output Overload Protection	Please charge/power the devices within the rated power of DC and then press the ON/OFF Button to resume the functions.
E8	USB Output Overload Protection	Please charge/power the devices within the rated power of USB and then press the ON/OFF Button to resume the functions.
E4/E5/E6/E9	Output Overload Protection	When E1/E7/E8 occurs, E4/E5/E6/E9 will be displayed to determine the problem more accurately. Please charge/power the devices within the rated powers and then push the corresponding button to restart.
E62	Over-long Charging Reminder	Stop charging after 100%.
E72	Charging Safety Protection	Unplug the charging cable and turn off the device, plug again after a period of time.

NOTICE:

If none of these solutions works, or if you see a different warning code than the listed codes above, please stop using the power station, make note of the warning codes, and contact customer service for further instruction.

■ TROUBLESHOOTING

Problem	Solutions	Remark
Unable to Charge	Check if the power adapter's cord is inserted fully into the DC input and wall plug.	Confirm whether it is a connecting problem.
	Check if the adapter indicator is on if connected well.	If the light is still off, please contact customer service for help.
	The charging indicator is on, still can't charge.	Contact customer service for help.
No Output	Ensure that the DC/USB/AC output ports are activated by pressing the DC/USB/AC OUTPUT ON/OFF BUTTON(S) for the port(s) in use.	Once the corresponding button (s) is pressed, the output Watts will show on the LCD screen.
	Check the connected cables are appropriately inserted into the devices and power station.	Confirm the connection condition.
	Confirm the power station is charged by reviewing the battery level.	Low battery will affect the outputs.
	Verify the watt data displayed on the LCD screen for an overload condition.	Overload will shut off the outputs (For more information, please see the error codes section).
Suddenly Interrupted When Using Output (s)	The power used by the electronic device exceeds the rated power of this product. Check if the connected device (s) is suitable for the power station by reviewing the output specifications in the GENERAL SPECIFICATIONS section.	Only plug in devices that DO NOT exceed the rated Watts. If you need a unit with a larger watt/hour capacity, you can either go to our website or contact customer service to see which unit is right for you.
	Check to see if the output power is low. If it is too low for some hours, the power station will automatically shut down. Please press the ON/OFF button to start the product.	Automatic shutdown for saving power. If you do not want the function, press the ECO button to turn it off.
	Check if it turns off automatically in case of the protection, lick overcurrent, over/under temperature, overloading, etc. If so, just press the power ON/OFF button to resume after the power station turns normal.	Several protections to ensure the safety use of power station.

If you are experiencing any other problems not listed above, please contact customer service for help.

■ WARNINGS

The warnings in this manual cannot cover all possible conditions or situations that could occur.

Please use the POWER STATION with common sense and caution. Always be aware of the environment around you while using the device and ensure the POWER STATION is being used safely and responsibly.

- **DO NOT** use the POWER STATION over its output rating. Overloading may risk instances of fire or personal injury, even though we have built-in overload protection.
 - **DO NOT** use the POWER STATION or AC Wall plug power adapter if it is damaged or modified. Damaged or modified batteries may exhibit unpredictable behavior resulting in fire, explosion, or risk of injury.
 - **DO NOT** subject to vibration, impacts, or drops. Secure the POWER STATION during transport. The housing may not show signs of damage, but internal components may have been compromised. It is advisable to replace it if any such severe events occur.
 - **DO NOT** expose the POWER STATION to moisture, rain, or snow.
 - **DO NOT** charge, use or store the POWER STATION in a bathroom or an area exposed to water, rain, or moisture.
 - **DO NOT** leave children or persons with reduced physical/sensory or mental capabilities/or lack of experience and knowledge, along with the POWER STATION, unless they have been given supervision or instruction concerning use of it by a person responsible for their safety.
 - **DO NOT** attempt to repair the POWER STATION or AC Wall plug power adapter. There are no user-serviceable components inside.
 - **DO NOT** handle the POWER STATION with wet hands.
 - **DO NOT** place the POWER STATION on its side or upside down while in use or storage. If rust, odor, overheating, or other abnormal circumstances are observed, stop using and contact customer service.
 - Children should be supervised to ensure that they **DO NOT** play with the POWER STATION alone.
 - The POWER STATION is only used for the emergency power station. It cannot always replace the standard AC or DC power of household appliances.
 - Keep away from high voltage electrical fields.
 - Risk of fire and burns. **DO NOT** open, crush, or heat above 104°F (40°C) or incinerate.
 - Use of a power supply, charger, or cable not recommended or sold by portable battery manufacturers may risk fire or injury to persons.
 - Should fluid from the inside of the POWER STATION come in contact with your skin or clothing, wash the affected areas with water.
 - The accessories included in the box should only be used with the POWER STATION.
 - **KEEP POWER STATION AWAY FROM PETS.**
-

■ CAUTIONS

Transportation: POWER STATION complies with all legal requirements for the transport of dangerous goods. The capacity of the lithium battery pack exceeds 100Wh. Based on international standards, if POWER STATION is transported by airplane, it must be transported by IATA standard packaging. IATA instructions and labeling requirements and the relevant declarations must be completed.



Not permitted on aircrafts.



Avoid dropping.



To preserve the battery lifespans, please use and recharge at least once every three months.



Do not disassemble.



Use original or certified charger and cables.



It's not waterproof, do not expose to liquids.



Avoid extreme temperature.



Please dispose of batteries and electronic goods by local regulations.



CONTACT US

 322 Paseo Tesoro, Walnut, CA 91789

 support@togopower.com

 1-855-801-0798

 www.togopower.com