

# SALUS<sup>®</sup>

## OPTIMA S THERMOSTAT

### SETUP GUIDE

SALUS North America, Inc.  
850 Main Street  
Redwood City, CA 94063  
www.salusinc.com

#### IN THE BOX YOU WILL FIND THE FOLLOWING:



Thermostat with Mounting Plate

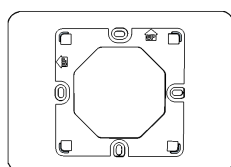

Wall Plate

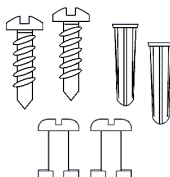

2 x Wood Screws  
2 x Wall Anchors  
2 x Locking Pins

Heat Pump HP (Wiring label)		Gas or Electric Non-HP (Wiring label)	
R	R	RC	RC
C	C	RH	RH
L	L	C	C
Y1	Y1	Y1	Y1
Y2	Y2	Y2	Y2
W1	W1	W1	W1
O/B	O/B	W2	W2
G	G	G	G

Wire Labels



2 x AA Alkaline Batteries

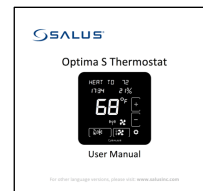

User Manual



Setup Guide

#### YOU WILL NEED THE FOLLOWING TOOLS:

- #1 Phillips or flathead screwdriver
- Drill with 3/16" bit  
(only if you cannot mount the thermostat using the existing holes)

#### Optional Tools

- Smartphone or digital camera to take picture of wiring for later reference
- Screwdriver to disconnect wires from old thermostat
- Pencil

#### STEP 1 TURN OFF POWER TO THE HVAC SYSTEM

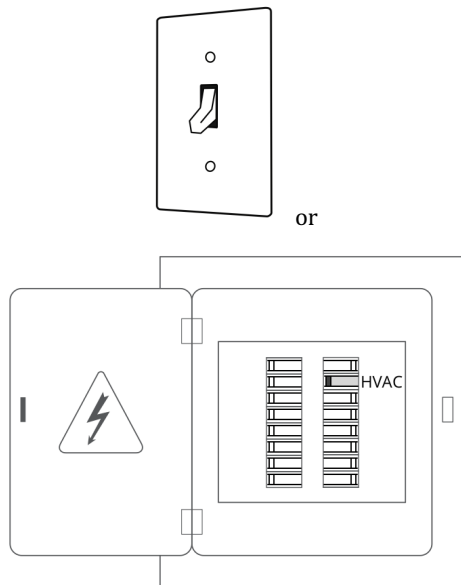

#### STEP 2 DETERMINE WIRING CONFIGURATION

Use the Wire Labels and the following table to keep track of wire colors on the old thermostat or on the heat pump / furnace / air conditioner.

HP	NON-HP	Wire Color
R	R or RH	
---	RC	
C		
Y or Y1		
Y2		
AUX	W or W1	
O/B	W2	
G		
L	---	

For new installations, refer to Appendix A and the "Install Mounting Plate" sections of the *Optima S User Manual*.

#### STEP 3 REMOVE OLD THERMOSTAT

Remove the old thermostat from the wall, taking care not to allow the wiring to fall inside the wall.

**TIP:** Wrap the wire ends around a long stick (such as a pencil) to keep the wires from falling into the wall.

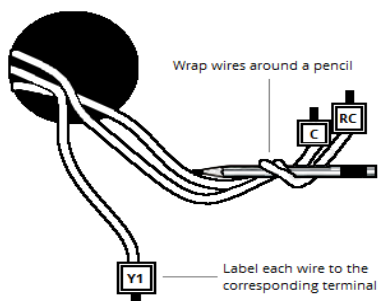

#### STEP 4 INSTALL MOUNTING PLATE

If there is space on the wall that needs to be covered, insert the Wall Plate between the Mounting Plate and the wall, and mount both plates using the same screws.

Make sure the wires run through the center opening.

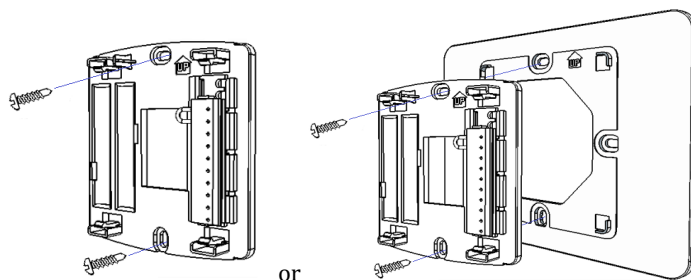

## STEP 5 ATTACH WIRING

- Using the labels, match the wires to the appropriate terminal.
- For each wire, press the terminal button and fully insert the wire into the side hole.
- Release the terminal button to secure the wire.
- If you have RC and RH wires, remove the jumper between RC and RJP.

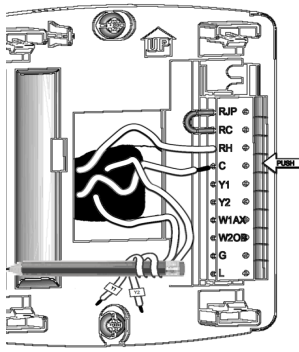

## STEP 6 CONNECT THE BATTERIES

Pull the battery tab from the back of the thermostat to activate the batteries.

- If the C wire is connected, the thermostat will draw power from the AC connection and use the batteries as backup.
- Battery-only operation typically lasts 18 months.

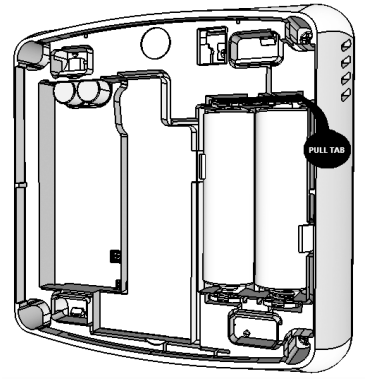

## STEP 7 INITIAL CONFIGURATION

After initial power-up, the thermostat will attempt to pair with a network for 10 minutes. **You may need to initiate scanning for devices in your connected home system.** Once paired, canceled with the Down button (  $\times$  ), or timed out, the device will ask for the following initial settings.

Use the Up (+) or Down (-) buttons to display the desired option, and Settings (  $\odot$  ) to enter that option.

Setting	Options	Description
Region	US	United States – Configures thermostat for use in the US.
	CA	Canada – Configures thermostat for use in Canada
Equipment Type	HP	Heat Pump
	NONHP	Non Heat Pump – Gas, electric, or oil heat
If HP: Reversing Valve	O	Heat Pump with O reversing valve
	B	Heat Pump with B reversing valve
If NONHP: Fan Control	FRNC	Furnace Control (Gas / Oil heat)
	TSTAT	Thermostat Control (Electric heat)

## STEP 9 TURN POWER BACK ON TO THE HVAC SYSTEM

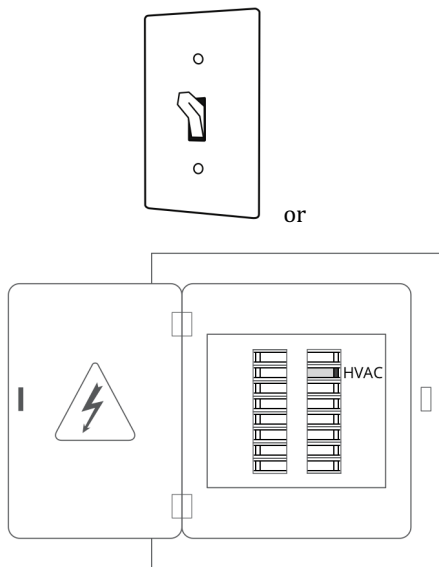

Congratulations on installing and setting up your new Optima S thermostat.

## STEP 8 ATTACH THERMOSTAT TO MOUNTING PLATE

After the initial configuration, the home screen will be displayed and the thermostat is ready to be attached to the Mounting Plate.

Align the connector pins and the plastic retention posts, then push the thermostat onto the Mounting Plate.

Make sure the connector pins are not bent and that the **thermostat is fully seated** on the Mounting Plate.

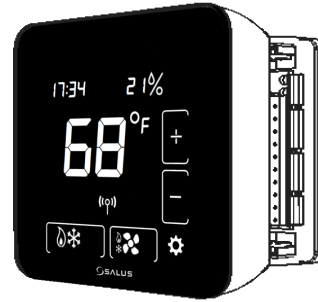

## OPTIONAL STEP CONFIGURE THE NEW THERMOSTAT

As you use the thermostat, and there are features you would like to customize, see the “Configuring the Thermostat” section in the *Optima S User Manual* for more details.

Settings that can be changed include:

Item #	Item Name	Description
1	Temperature Units	Celsius or Fahrenheit
2	Brightness	Display brightness when active
3	Display Mode	Full or Simple display mode
4	Display On Time	Length of time the display stays on
5	Set Point Span	Accuracy of heat/cool set point
6	Frost Protect Point	Set point to call for heat regardless of mode.
7	Offset	Adjustment to temperature reading
8	Language	English, French or Spanish
9	Region	US or Canadian defaults
10	Equipment Type	Heat Pump or Conventional system
11	Fan Control / Reversing Valve	Additional setting for Equipment Type: Furnace or thermostat fan control / O or B reversing valve
12	Clock Format*	12 or 24 hour display format <i>Only available when paired with a network</i>
13	Identify	Initiate ZigBee IDENTIFY function for 10 minutes
14	Start Pairing	Deletes network settings and attempts to pair with a network
15	Factory Default	Resets the thermostat to Factory settings