



Red | CN

cloud **node**

Quick Start Guide



View the user manual here:
prodatakey.zendesk.com

PN: RCNEW

www.prodatakey.com
801.317.8802

1. Package Contents



Red Cloud Node Controller (1)



Can Lock (1)



Diode (1)



Battery Leads (1)



Jumpers (2)



Antenna (1)



Enclosure Screws (2)

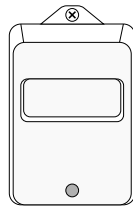

Transformer (1)
14 VDC, 2 Amp

2. Mounting Controller

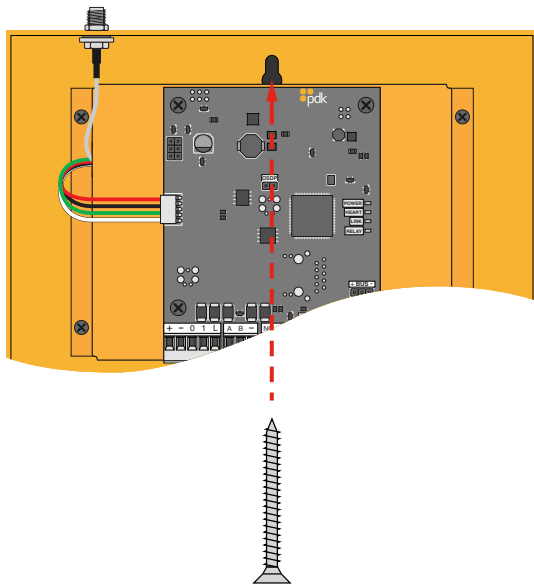

Mounting - Mount the enclosure securely to a wall.

3. Reader Connection

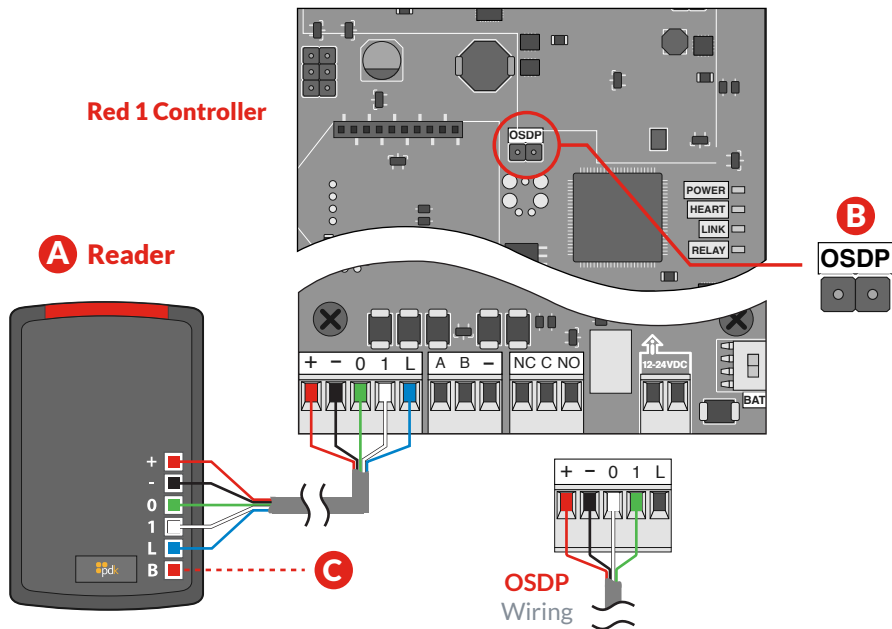

- A Reader** - The reader is mounted at the door with a 22/5 or 22/6 wire running to the door controller. Wire the reader to the controller as shown above. Be sure to check the polarity and voltage prior to powering the controller.
- B OSDP** - Place jumper to enable OSDP (see OSDP reference guide at the end of this guide for more info)
- C Piezo** - Can be connected to available relay and configured with software.

4. Input A / DPS Connection

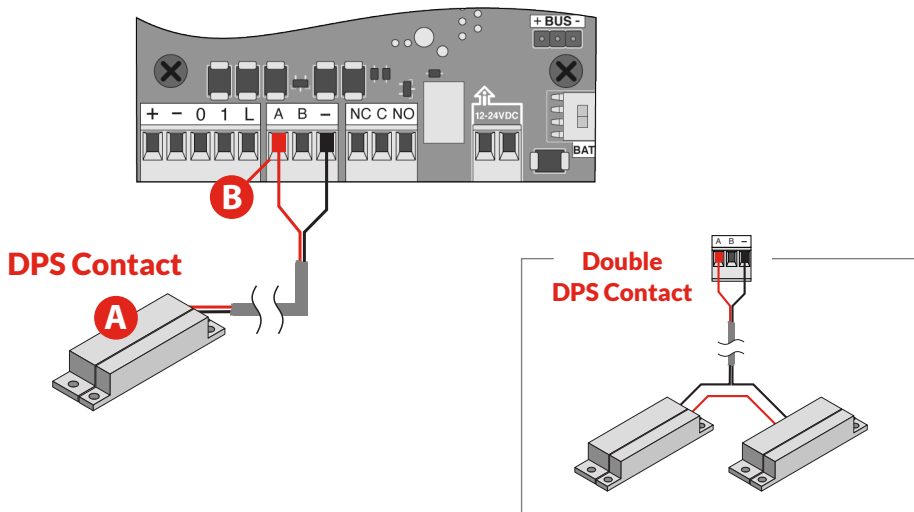

A **DPS (Door Position Sensor)** - The DPS is mounted on the door frame with a 22/2 wire running from the DPS to the controller. Wire the DPS to the controller as shown above. For reporting double doors, wire the two-door position in series and connect to the controller.

B **AUX Input** - A software rule can be programmed to trigger events or outputs based on input triggers.

5. Input B / REX Connection

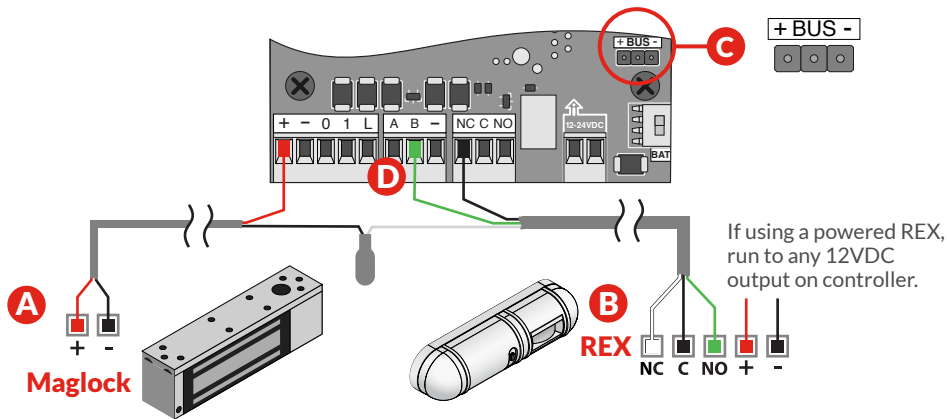

- A Maglock** - When installing a Maglock, it is typical to install a REX (request to exit) at the door for free egress. Run an 18/2 wire from the maglock to the controller and REX as shown.
- B REX (Request to Exit)** - The REX is mounted at your desired location with an 18/5 wire. Wire the REX to the controller and maglock, as shown above. If reporting is not needed in the system, simply eliminate the green input wire.
- C Jumper Block** - Use to designated (+) or (-) board voltage out of NO and NC. If the jumper is off, the relay is a standard dry contact requiring an input into C on the relay.
- D AUX Input** - A software rule can be programmed to trigger events or outputs based on input triggers.

6. Locking Relay

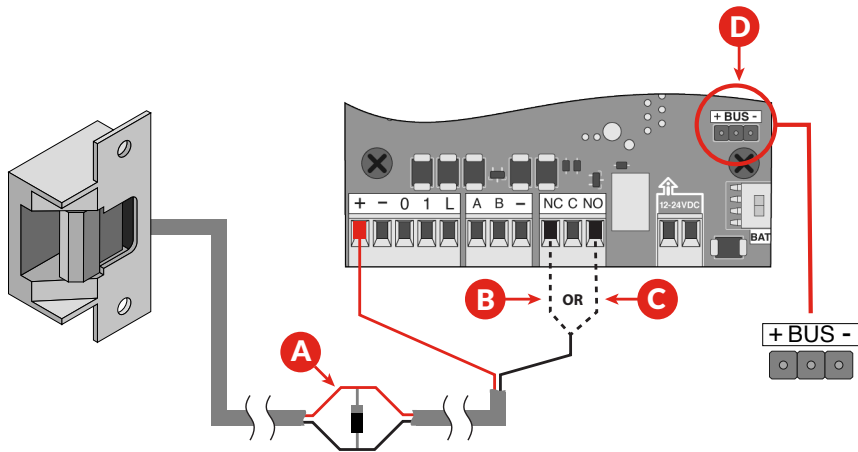

- A Diode** - The provided diode must be installed when using a strike. Install at the strike with the gray stripe on positive and the black on negative.
- B NC** - Used for maglocks (or strikes in fail-safe configuration). Connect the negative (-) of the maglock or strike to NC on the controller.
- C NO** - Used for strikes in fail-secure configuration. Connect the negative (-) of the strike to NO on the controller.
- D Jumper Block** - Use to designate (+) or (-) board voltage out of NO and NC. If the jumper is off, the relay is a standard dry contact requiring an input into C on the relay.

7. Communication Connections

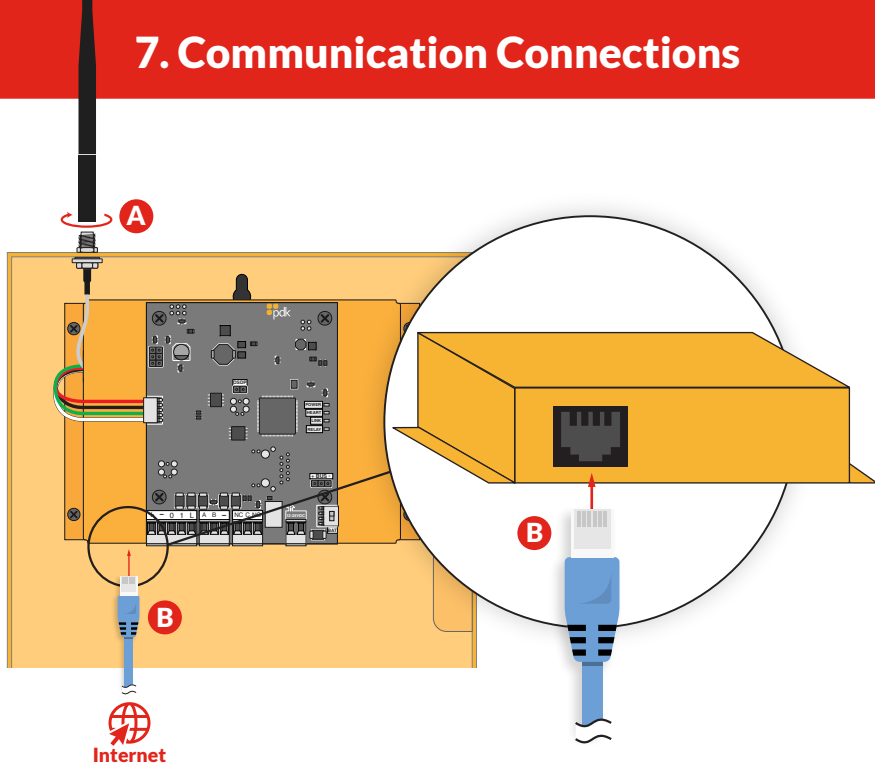

- A WiMac Wireless Antenna** - Connect the antenna to the top of the enclosure.
- B Network** - A live internet connection is required to program and manage the system.
- C Connect** - Connect the Cloud Node to the network by plugging an Ethernet connection into the node.

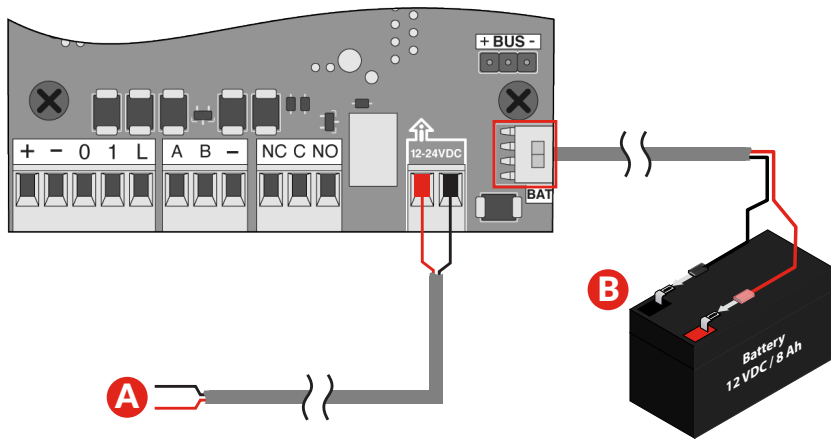

8. Power Connection



A DC Input - Input 12-24 VDC power using an 18/2 wire. For high voltage applications, use the High Voltage Converter (PN: HVC).

B Backup Battery - The enclosure will fit most 12 VDC 8 Ah batteries. Connect the battery to the controller using the supplied battery leads.

9. Cloud Node Registration

- A** Login to your pdk.io account and click the plus icon  next to Customers.
- B** Enter the customer name and click Create.
- C** Select the customer and click the plus icon  next to Cloud Nodes.
- D** Enter the Cloud Node serial number and a Name, then click Register.

OSDP Reference Guide

What is OSDP - Open Supervised Device Protocol (OSDP) is an access control communications standard developed by the Security Industry Association to improve interoperability among access control and security products. OSDP brings heightened security and improved functionality. It is more secure than Wiegand and supports AES-128 encryption.

OSDP Wire Specification - Four-conductor, twisted-pair cable with overall shield is recommended to remain fully TIA-485 compliant at the maximum supported baud rates and cable distances. **Note** - It's possible to reuse existing Wiegand wiring for OSDP. However, using a simple stranded cable typical of Wiegand readers generally does not meet the RS-485 twisted pair recommendations.

OSDP Multi-Drop - Multi-drop gives you the capability to accommodate many readers by running one length of four-conductor cable, eliminating the need to run wire for each reader.

Note - The maximum number of readers each port can support is four.

Note - Wiegand readers will not work when OSDP jumpers are installed.

Reference Guide

Fire Input - To integrate the fire system into a controller, refer to wiring diagrams at www.prodatakey.zendesk.com

Programming - After the controller is connected, access the configuration software as instructed in the programming manual available at www.prodatakey.zendesk.com

Reader Compatibility - PDK does not require proprietary readers. Controllers accept a Wiegand input, including biometric readers and keypads. OSDP readers are supported by using the included jumper (see OSDP reference guide). Contact PDK support if assistance is needed.

UL 294 Compliance - All equipment must meet appropriate UL certifications. For UL-listed installations, all cable runs must be less than 30 meters (98.5').

Part Number - RCNEW

PDK Technical Support

Phone: 801.317.8802 Option #2

Email: support@prodatakey.com

Knowledge Base: www.prodatakey.zendesk.com