

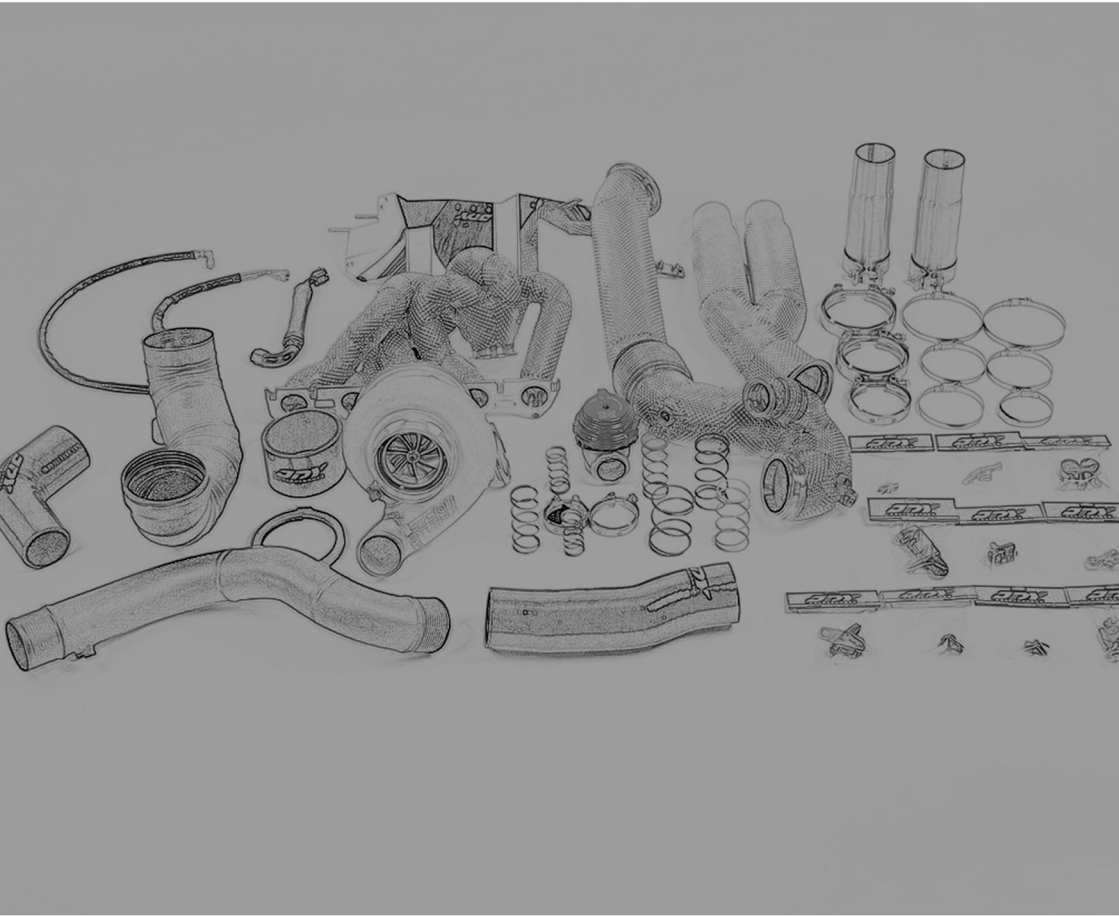

INSTALLATION GUID-V2!-2.5TFSI

JDY TTRS 8SRS3 8V2 DAZA DNWA Turbo Kit - Direct Fit

Instruction Manual



Notes:

When disassembling the car, be sure to keep all fasteners so they can be reused. It is recommended that you get some kind of compartmented tray to organize the fasteners, such as a fishing tackle box or several large ice cube trays. All directions used in this manual (right, left, front, etc.) are based on if you were sitting in the driver seat of the car.

These instructions assume that you have basic mechanical skills and several varieties of basic hand tools in order to install the kit. If you have any questions about the installation, feel free to contact our JDY representative.

Installation guid-V2!-2.5TFSI JDY TTRS 8SRS3 8V2 DAZA DNWA Turbo Kit - Direct Fit

NO		Descripton	Specification	Quantity
1		Exhaust Mainfold	45mm Outside Diameter	1
2		6870 Precision Turbo	V-BAND	1
3	Assembly	Downpipe	89mm Outside Diameter	1
4		Oxygen Sensor Block	M18*1.5	1
5		Ø18 Copper Pad	Ø18	1
6		Stainless Steel Screw (Hexagon Socket Head Cap Screw)	M8*20	2
7		Stainless Steel Washer	Ø10	2
8		Stainless Steel Nut	M8	2
9	Assembly	Exhaust Midpipe	89mm-76mm	1
10		Exhaust Clamp With Fitting Tube To Catpipe	76mm-65mm	2
11		Clamp	76mm	2
12		Turbo Hotside Inlet Clamp	3.0 In	1
13		Turbo Hotside Outlet Clamp	3.5 In	1
14		Exhaust Midpipe Downpipe Clamp	3.5 In	1
15		Tial Wastegate MVR 44mm	MVR	1
16	Assembly	Turbo Intake Pipe	101mm	1
17		M6 Stainless steel round head screw	M6*15	1
18		Ø6mm Stainless steel washer	Ø6	1
19		O Ring		2
20		Intake silicon elbow	70cm	1
21	Assembly	Intake Pipe Aluminum Clamp A	M4 thread	1
22		Intake Pipe Aluminum Clamp B	M5 thread	1
23		Intake Pipe Bolt (Hexagon socket head cap Stainless steel)	M5*15	2
24		High-Frequency Solenoid Valve Mount Board		1
25		High-Frequency Solenoid Valve Mount Bolt	M4*10	2
26		High-Frequency Solenoid Valve Screw		2
27		High-Frequency Solenoid Valve Nut		2
28		110*57/63mm to 70mm Boost Silicon Pipe	57/63mm-70mm	1
29		Boost Aluminium Pipe	70mm	1
30		70mm to 70mm Boost Silicon Pipe	70	1
31		Water Pipe Bracket	14mm	2
32	Assembly	Turbo Oil Outlet Pipe Flange		1
33		Turbo Oil Outlet Pipe Flange Seal		1
34		Turbo Oil Outlet Flange Bolts (Full Threaded)	M8*35	1
35		Turbo Oil Outlet Flange Bolts (Half Threaded)	M8*35	1
36		Turbo Oil Outlet Pipe Flange Bolt Washer	8*12*1.2mm	2
37	Assembly	Turbo Oil Pipe Flange (Cylinder Block Side)	AN10	1
38		Turbo Oil Pipe Flange Seal(Engine Block Side)		1
39	Assembly	Turbo Oil Pipe Inlet Fish Eye Fitting	AN4	1
40		Turbo Oil Inlet Pipe Hollow Bolts (Cylinder Block Side)	M10*1	1
41		Turbo Inlet Pipe Washer (Cylinder Block Side)	Ø10	2
42		Turbo Oil Inlet Flange (Engine Block Side)		1
43		Turbo Oil Inlet Flange O-ring		1
44		Turbo Oil Pipe Inlet Bolt 1/8NPT to AN4	1/8NPT-AN4	1
45	Assembly	Turbo Water Bypass Inlet Flange		1
46		Turbo Water Bypass Inlet Flange O-ring		1
47		1/8 NPT to AN6 Fitting	1/8NPT-AN6	1
48		Exhaust Manifold EGT Sensor Block	1/8 NPT	5
49		Exhaust Manifold Bolt M8	M8	12
50		Exhaust Manifold Fasteners M8 Copper (With Washers)	M8	12
51		Turbo Oil Outlet Pipe 120 Degrees - 60 Degrees	AN10	1
52		Turbo Oil Inlet Pipe 45 Degrees - 90 Degrees	AN4	1
53		Engine Water Bypass Pipe 45 Degrees - Straight	AN6	1
54		Clamp 100mm-120mm		2
55		Clamp 70mm-90mm		1
56		Clamp 70mm-90mm		3

1.Remove the Engine from the Engine bay

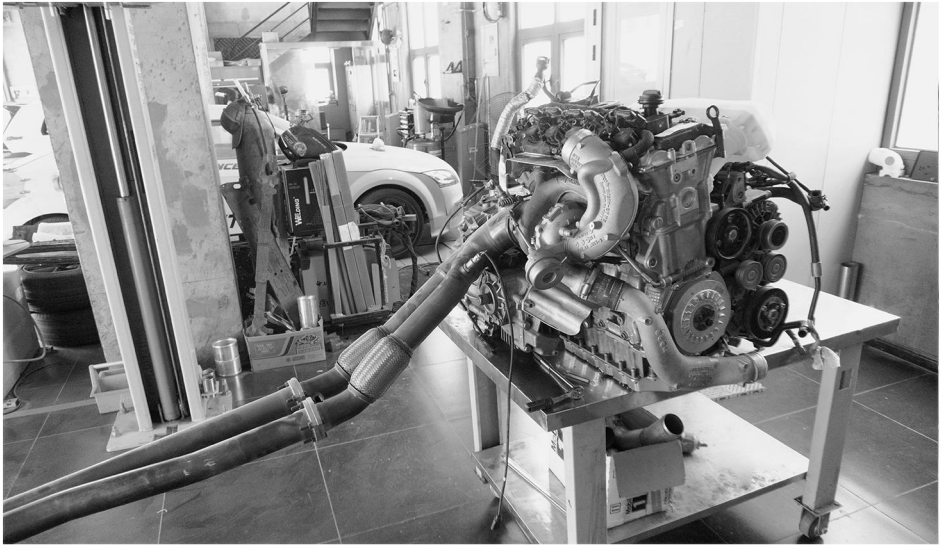

2.Remove the OEM Downpipe Clamp with T25 Socket

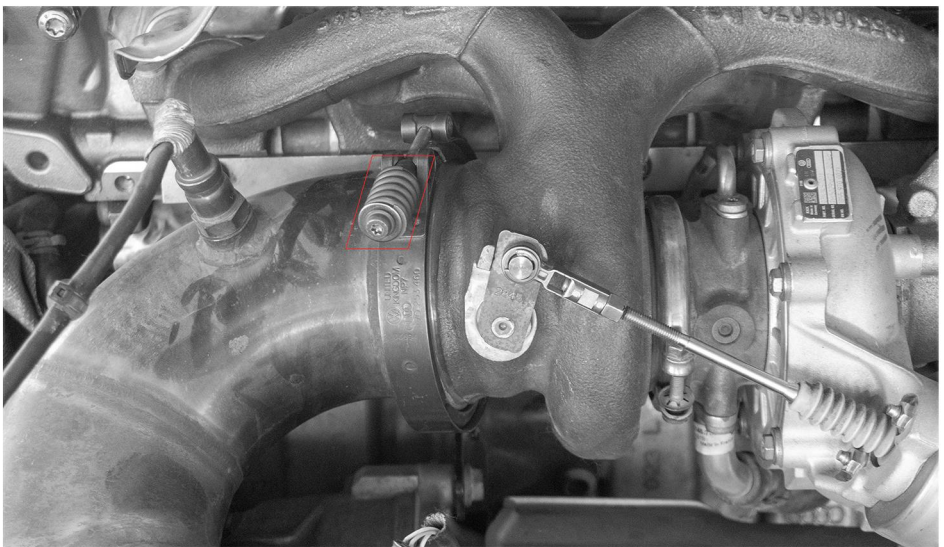

3.Remove the OEM Downpipe

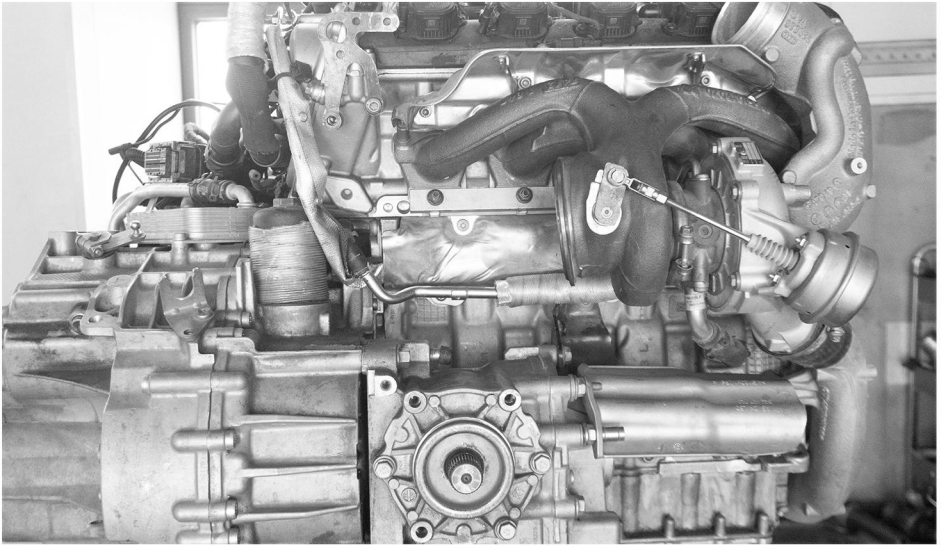

4.Remove the Bolts on OEM EGR(Exhaust Gas Recirculation) Pipe with T30 Socket



5.Remove the OEM EGR Pipe(Exhaust Gas Recirculation)



6.Remove the Bolts on the Turbo Inlet Pipe with T30 Socket

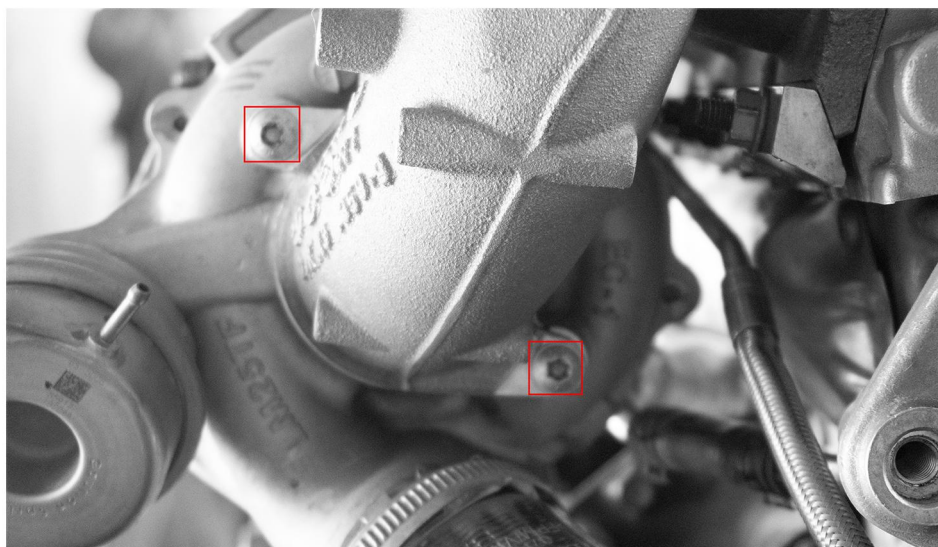

7.Remove the OEM Turbocharger Inlet Pipe

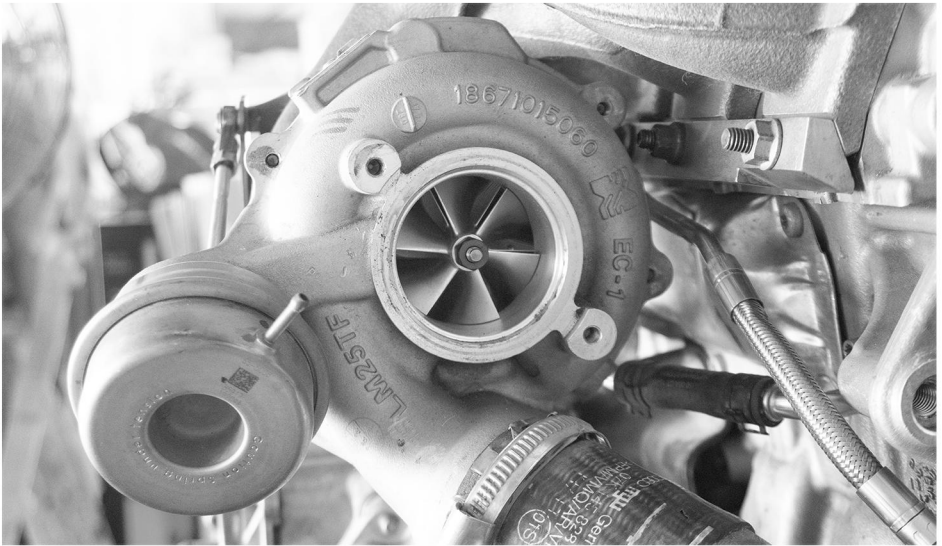

8.Remove the Bolts on the OEM Charge Aluminum Pipe Bracket with T30 Socket

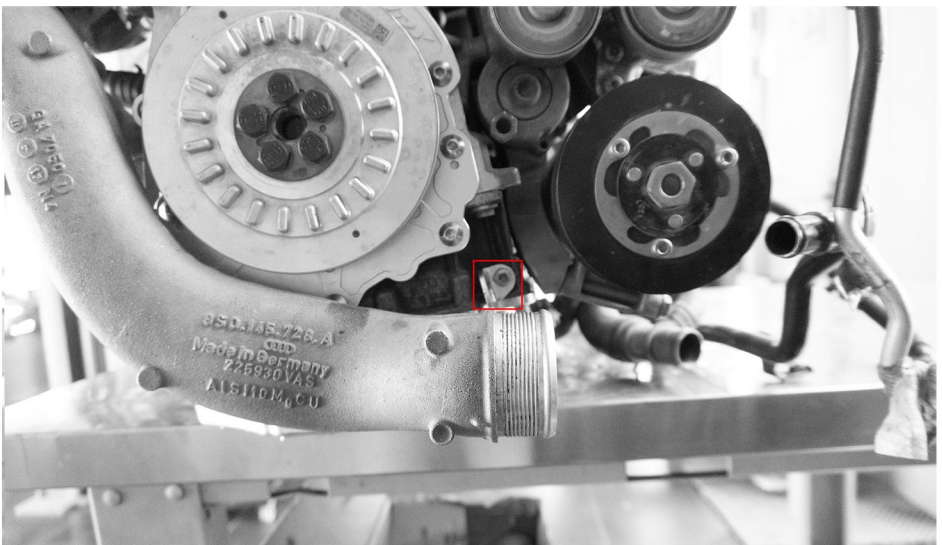

9.Remove the Bolts on the OEM Charge Aluminum Pipe Bracket with H6 Socket

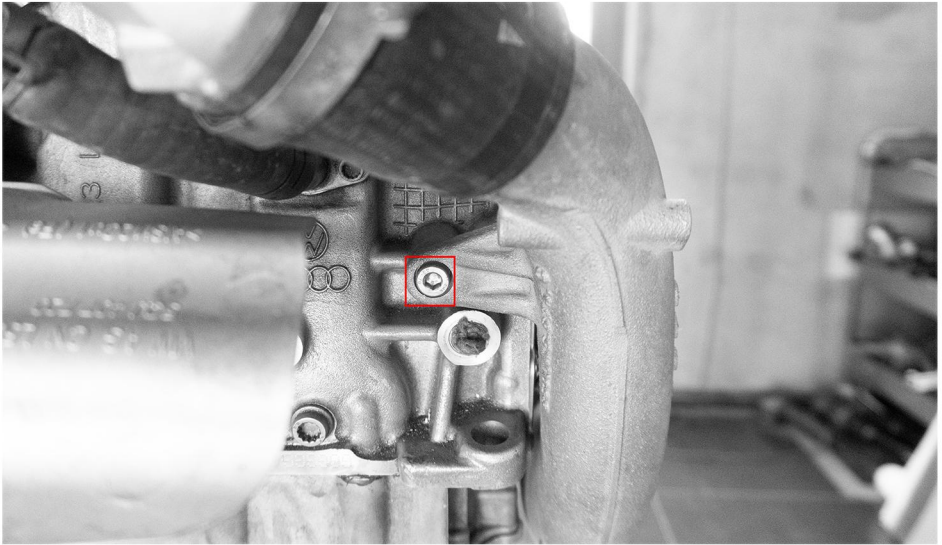

10.Remove the OEM Charge Silicon Pipe Clamp with 7mm Socket

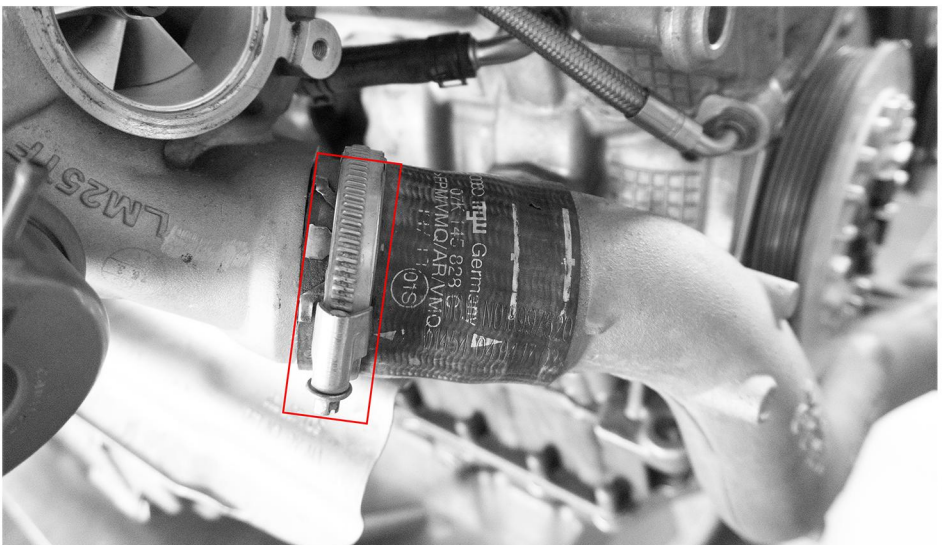

11.Remove the OEM Charge Pipe

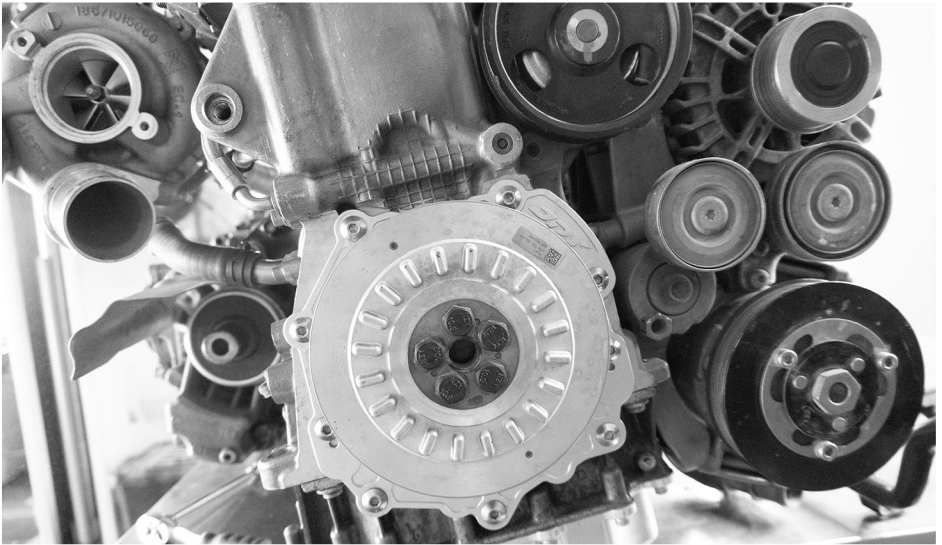

12.Remove the Bolts on the OEM Oil Inlet Pipe from Cylinder Block with M8 Socket

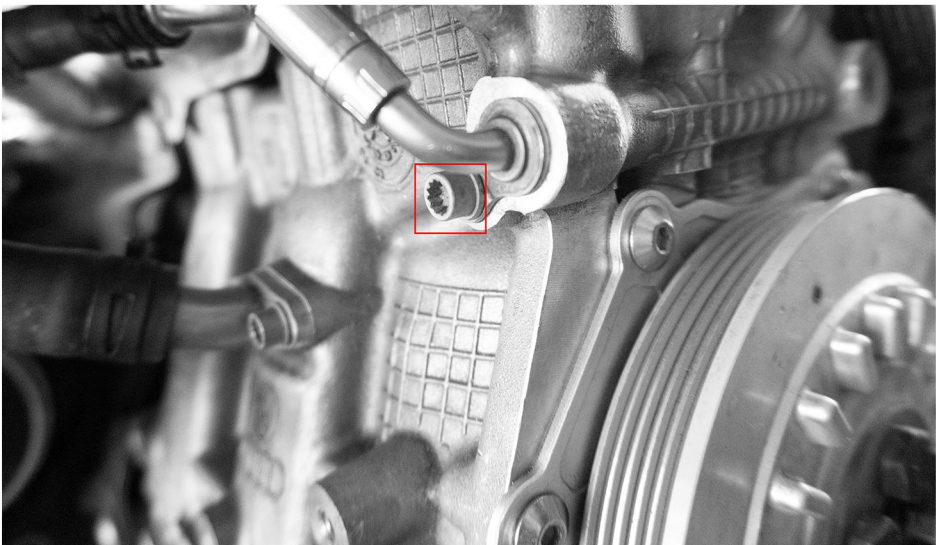

13.Remove the OEM Oil Inlet Pipe

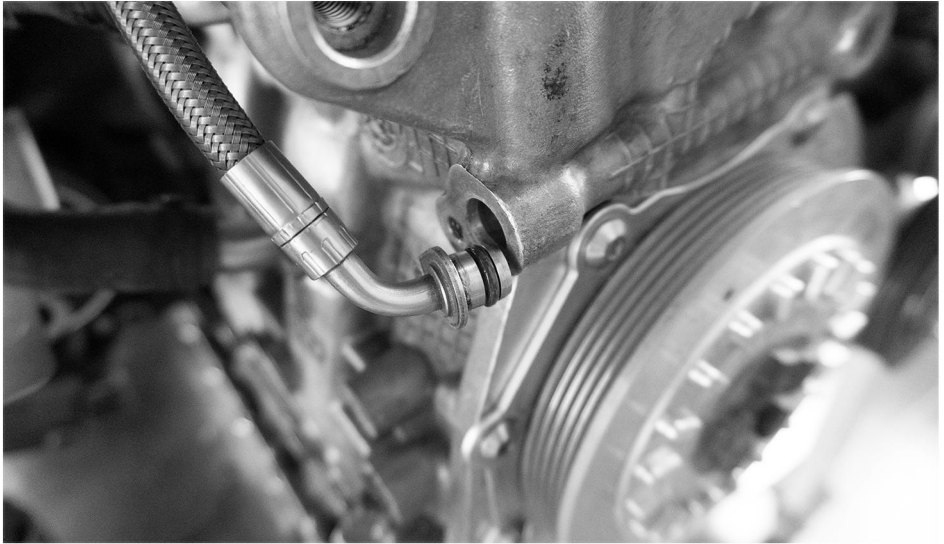

14.Remove the Bolts on the OEM Water Pipe from Cylinder Block with M8 Socket

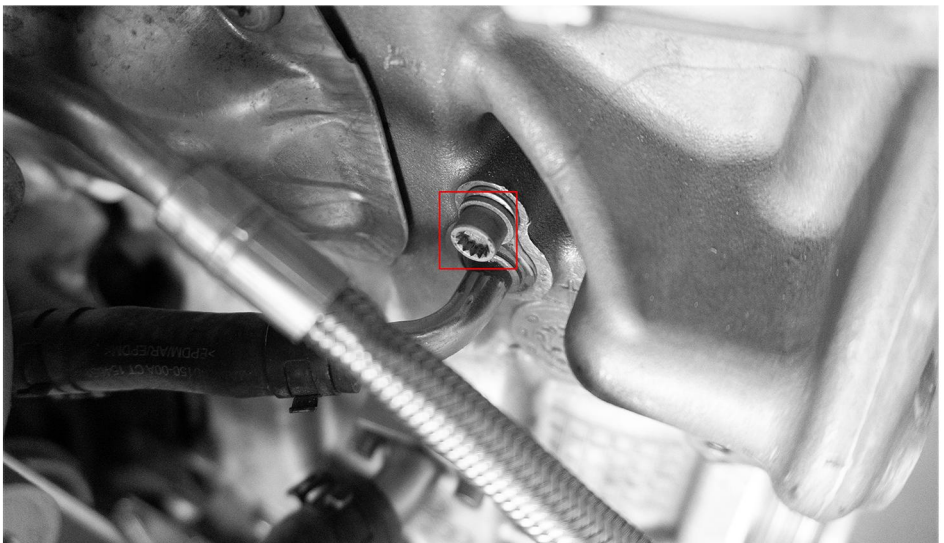

15.Remove the OEM Water Pipe

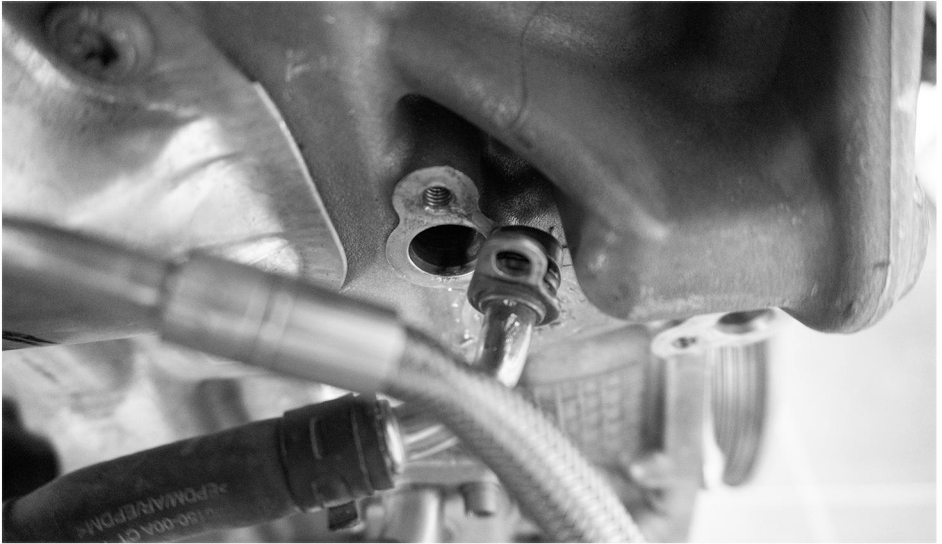

16.Remove the Bolts on the OEM Turbo Oil Return Line with M8 Socket

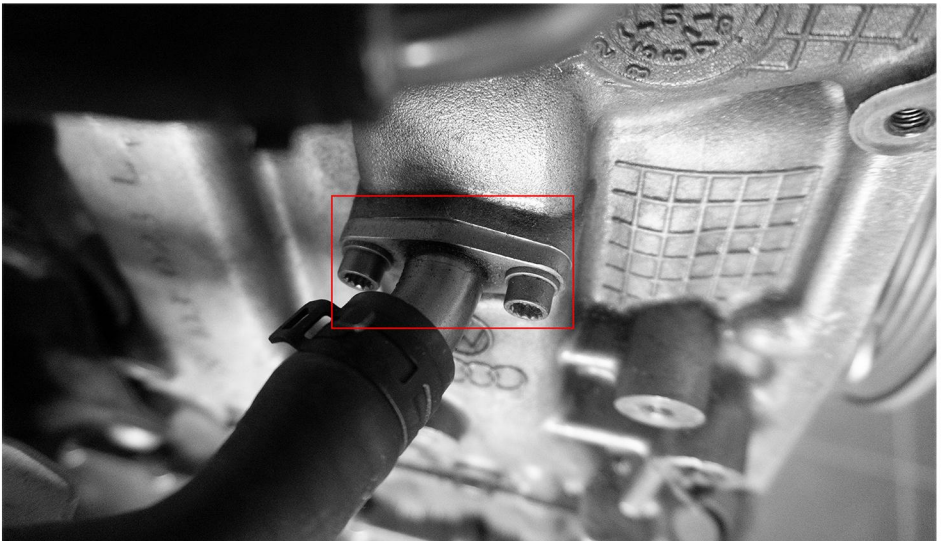

17.Remove the OEM Turbo Oil Return Line

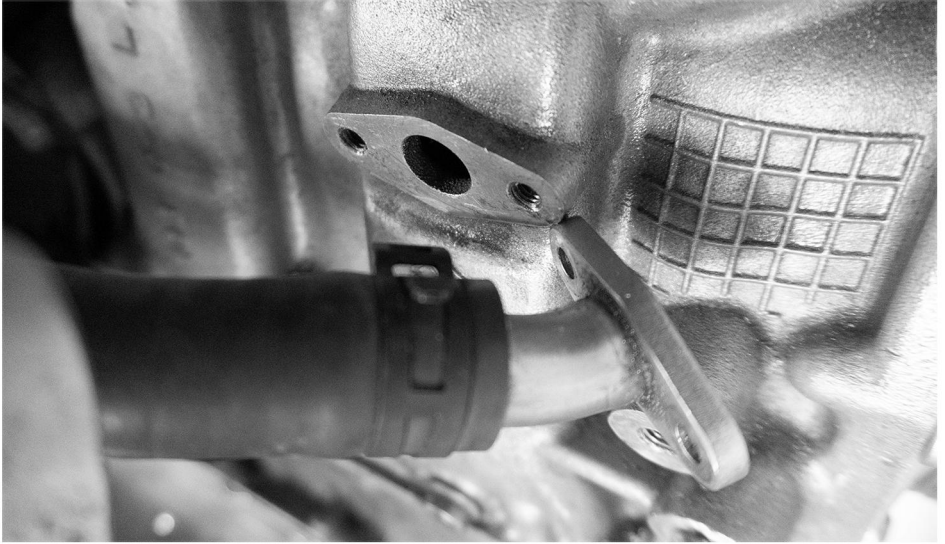

18.Remove the OEM Turbo Water Return Line Clamp

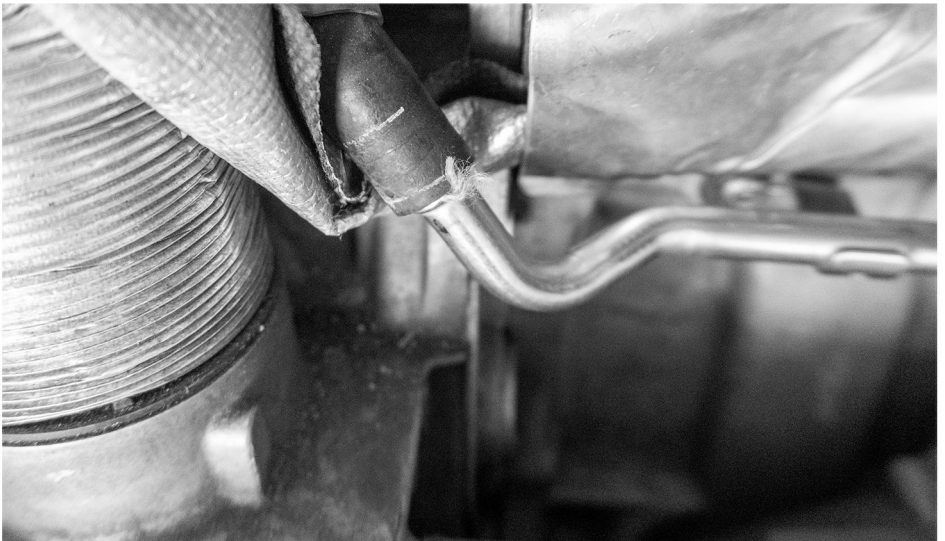

19.Remove the OEM Turbo Water Return Line

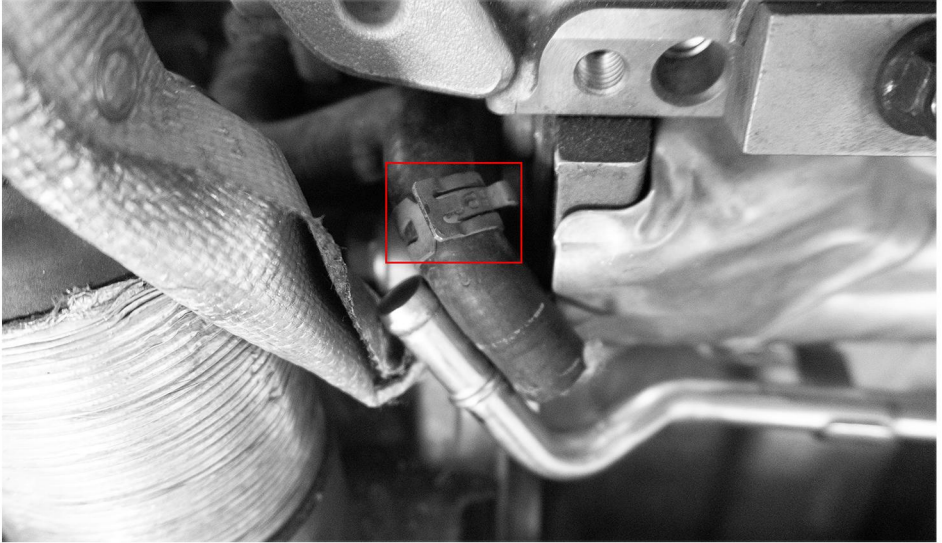

20.Remove the bolts on Turbo Water Return Line with T30 Socket

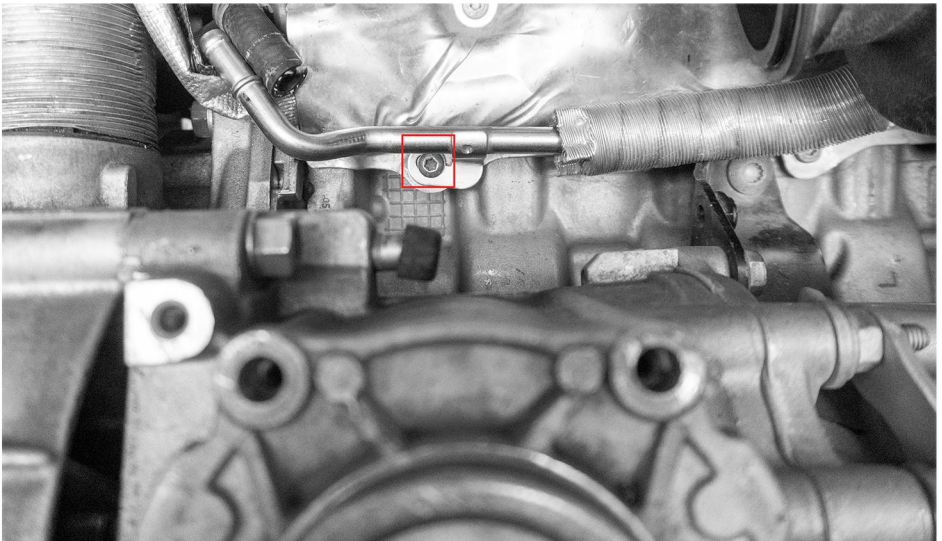

21. Remove the Bolts on OEM Heat Shield with H5 Socket
Remove the OEM Heat Shield"

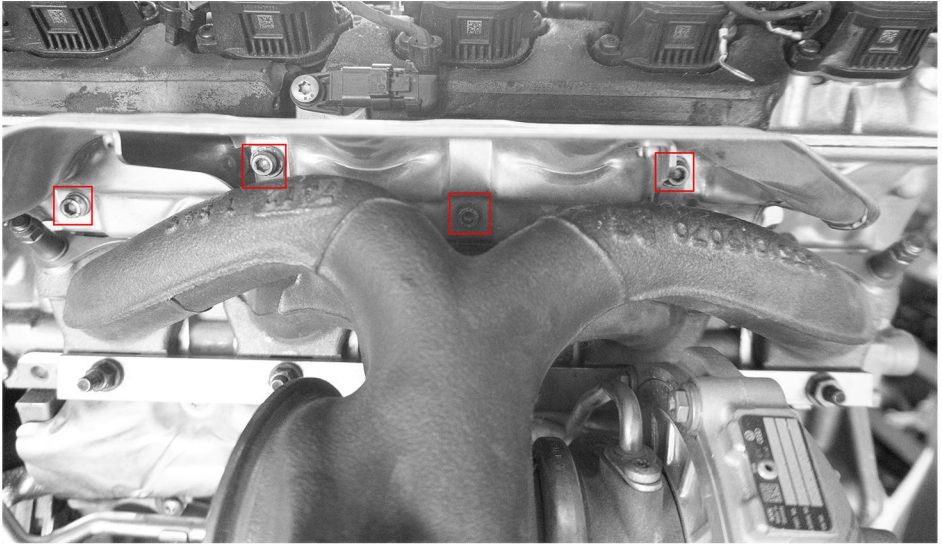

22. Remove the Bolts on OEM Exhaust Manifold with 11mm Socket

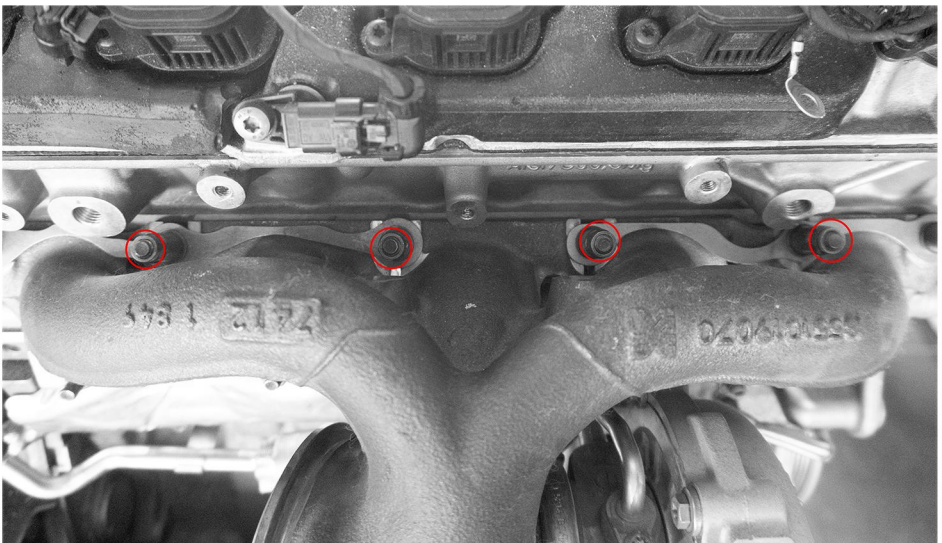

23.Remove the OEM Washers on the Exhaust Manifold Bolts

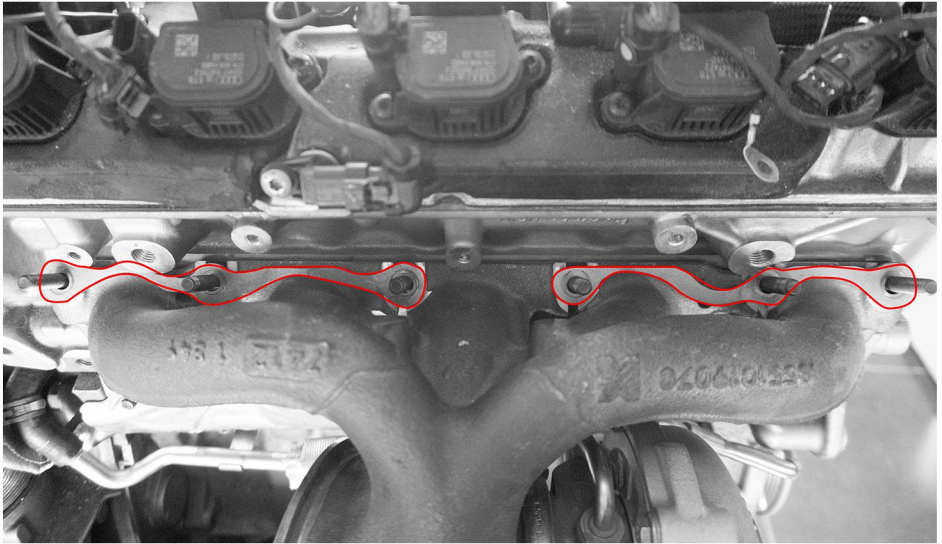

24.Remove the OEM Turbocharger

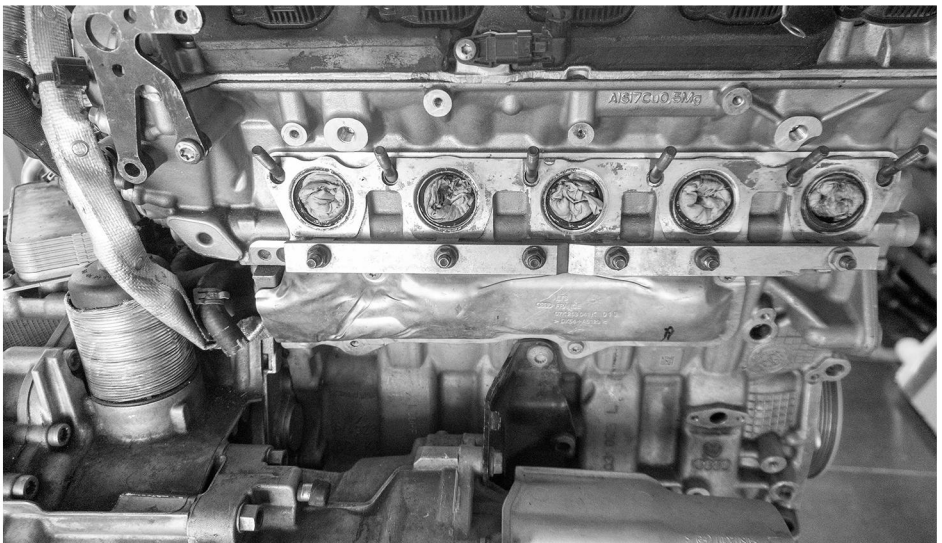

25.Remove the Bolts on the OEM Exhaust Manifold Shackle plate with 12mm Soc27.Remove the studs on the OEM Exhaust Manifold ket

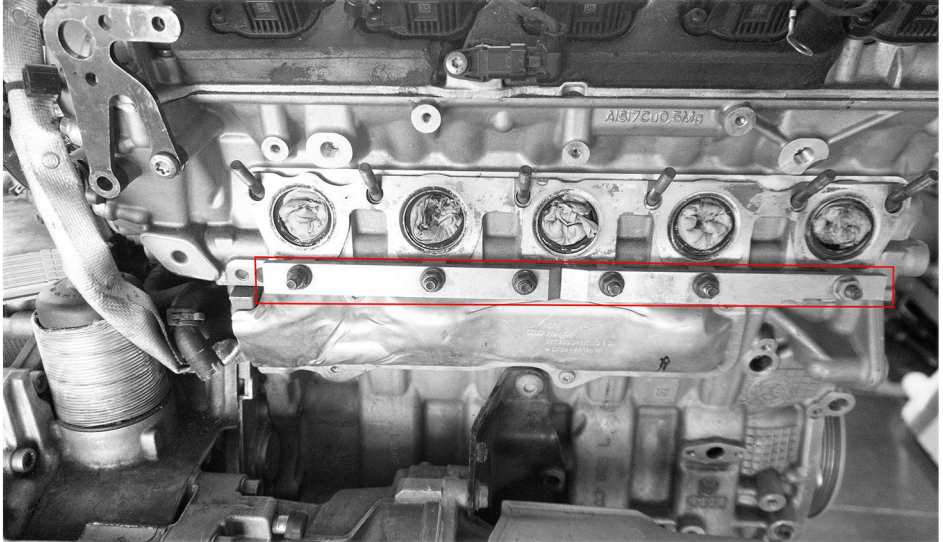

26.Remove the OEM Exhaust Manifold Shackle plate

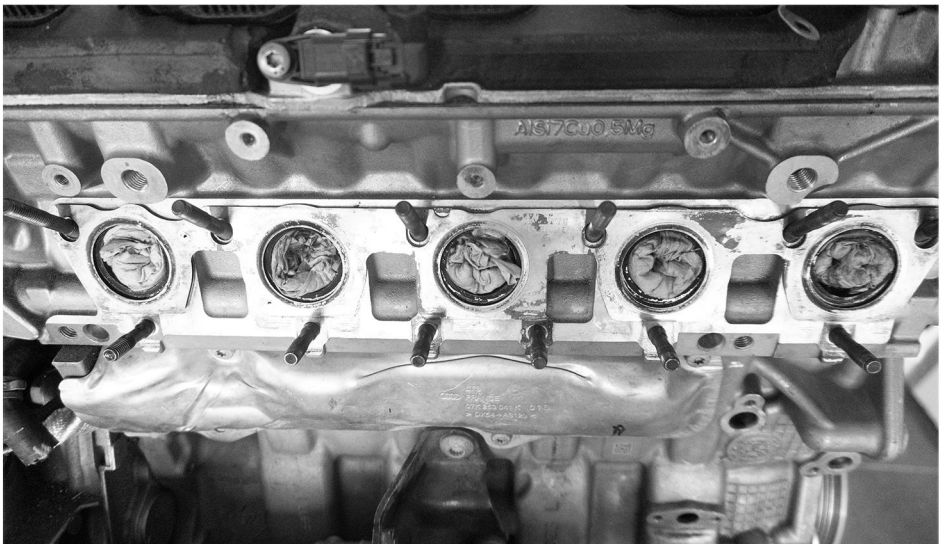

27.Remove the studs on the OEM Exhaust Manifold

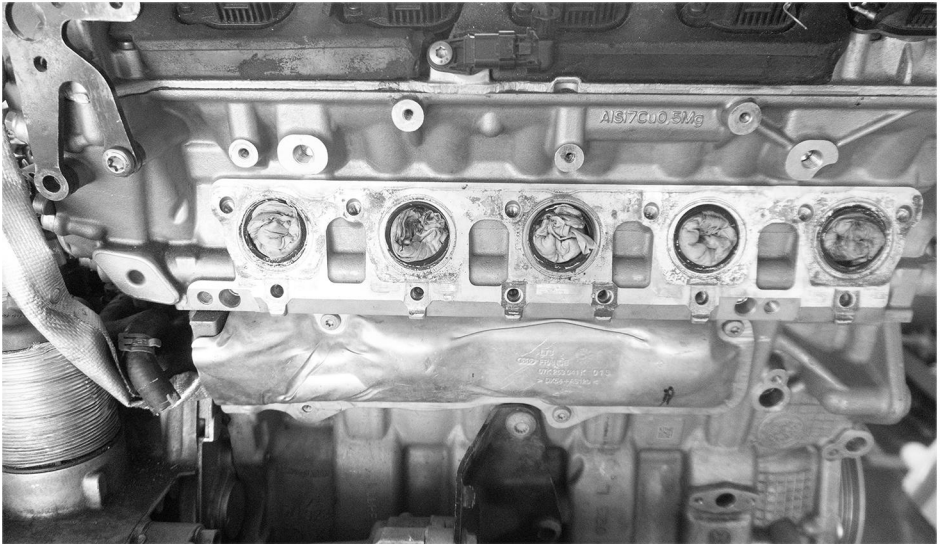

28.install the twin thread Studs supplied by JDY on the Exhaust Manifold

Note: Please make sure the end with less threads is fixed onto the Cylinder Head. Don't forget to apply Screw Sealant before taking the action

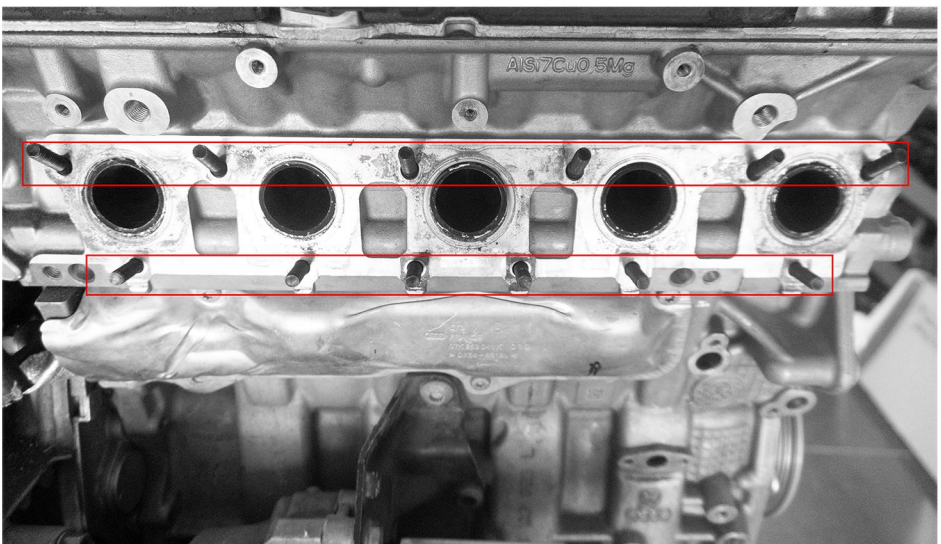

29. Install the OEM Exhaust Manifold Gasket

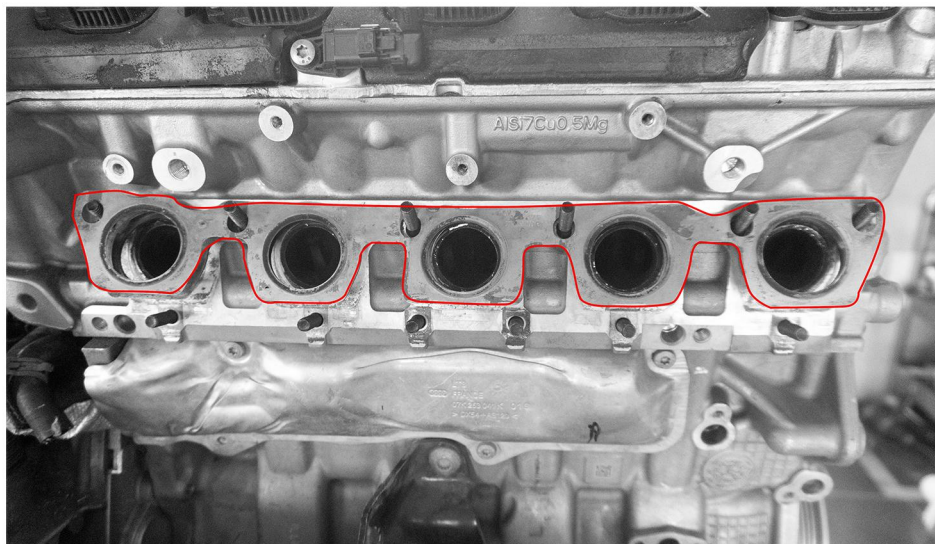

30. install the JDY Heat Shield with the bolts supplied by JDY using H5 Socket with Torque applied at 10NM

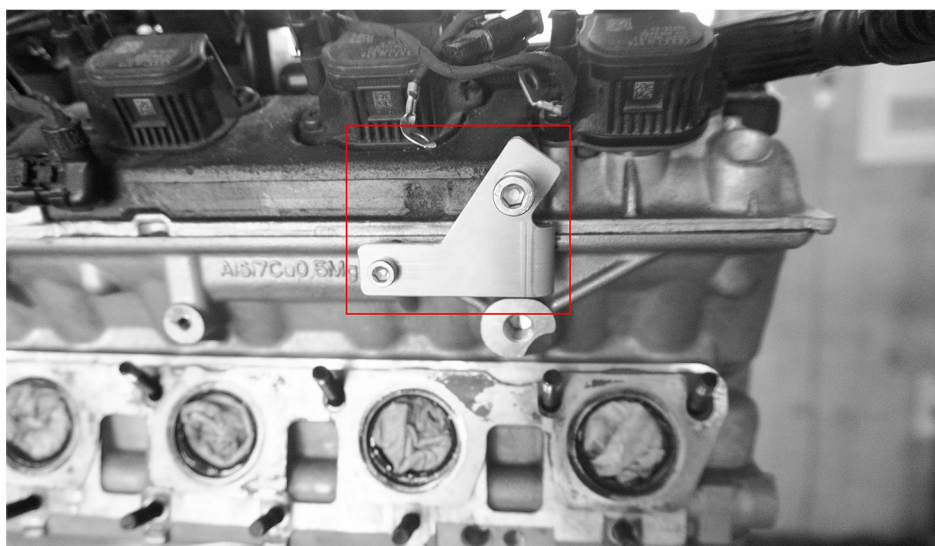

31. by using M8 socket, install the coolant return flange on the engine block, with torque of 10nm

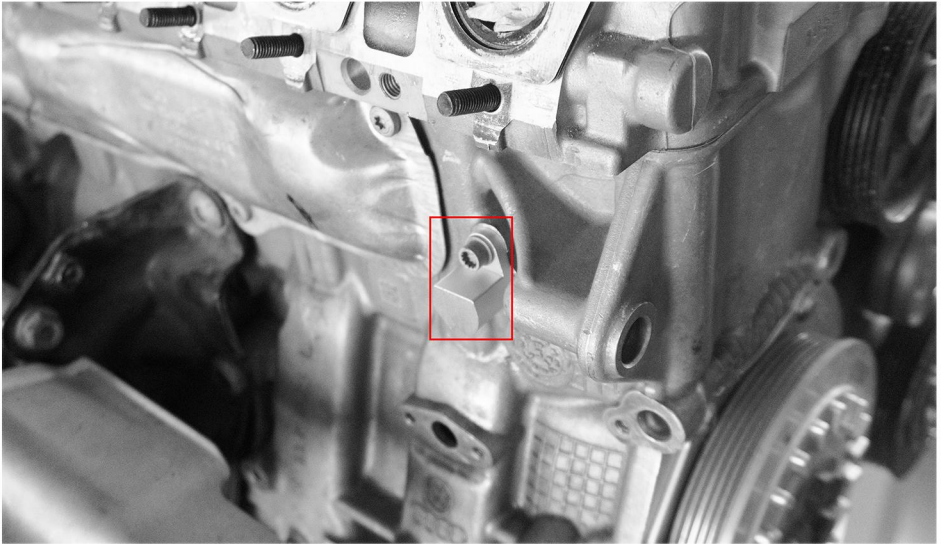

32. install the JDY 1/8NPT To AN6 Fitting on the Flange installed from previous step with 16mm Socket

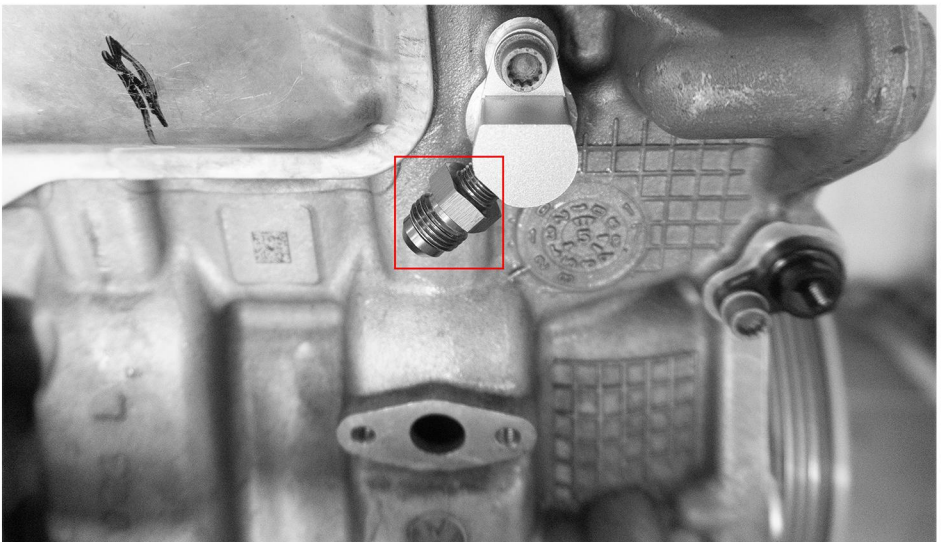

33. Install the coolant Return Line supplied from JDY onto the 1/8NPT To AN6 Fitting with 19mm Wrench

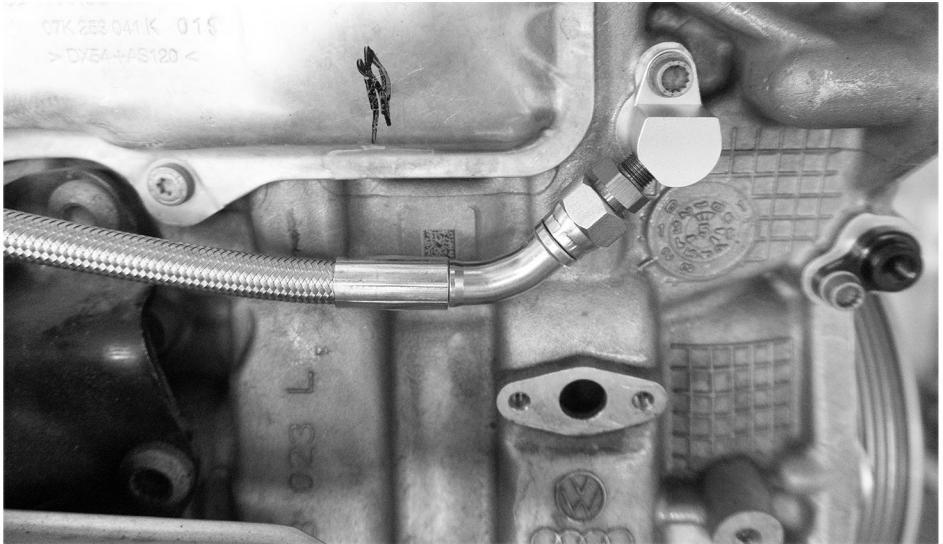

34. Connect the coolant Return Line

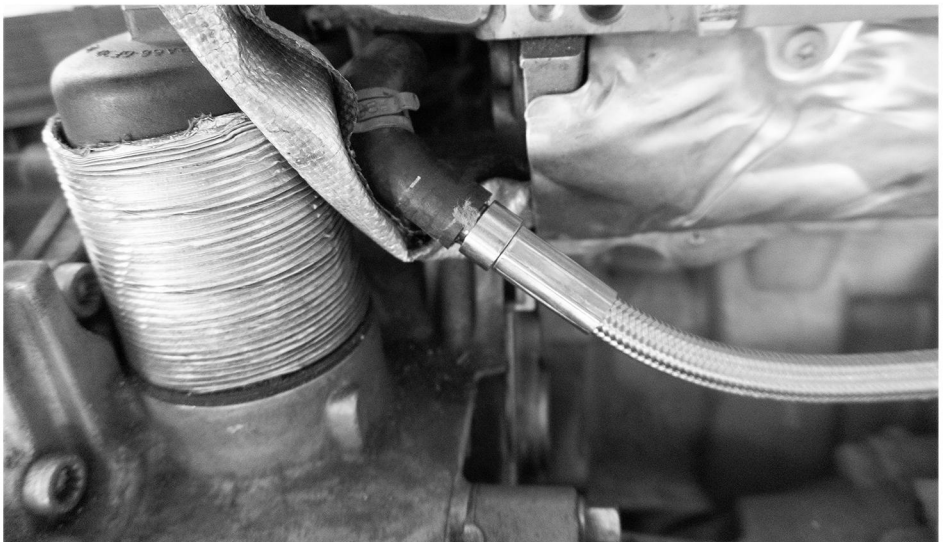

35.As shown in the pic

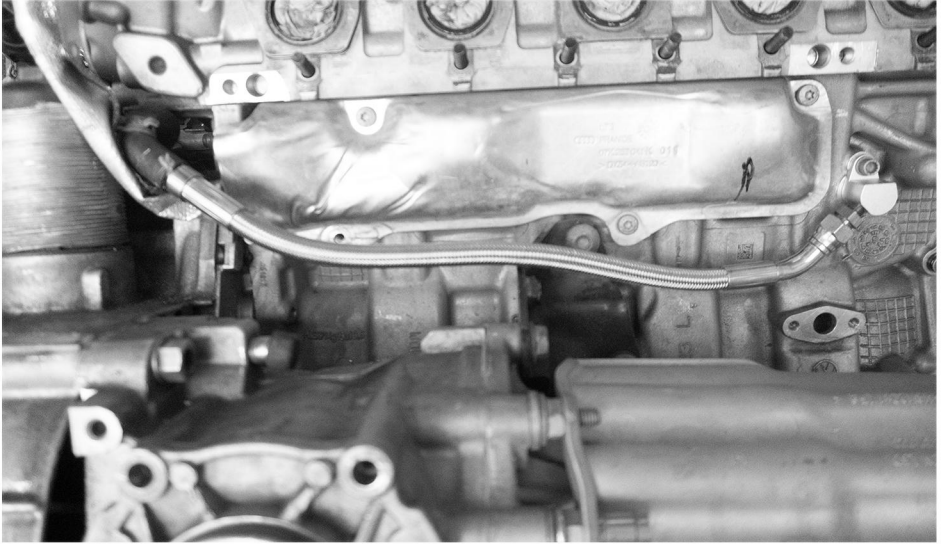

36.Install the JDY Flange to Cylinder Block using OEM Bolts with Torque applied at 10NM

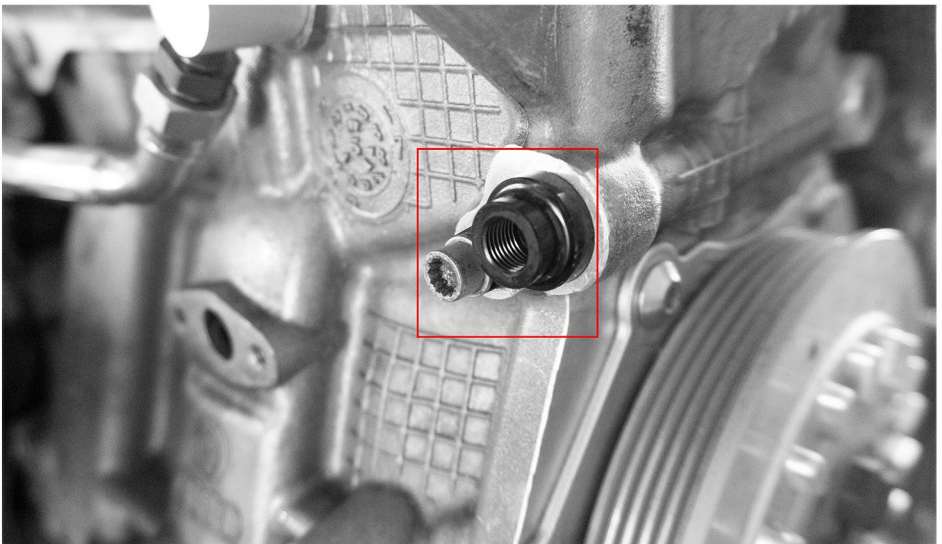

37. Install the Hollow bolts, Hollow Bolt Washers and AN4 Fitting with 14mm Socket

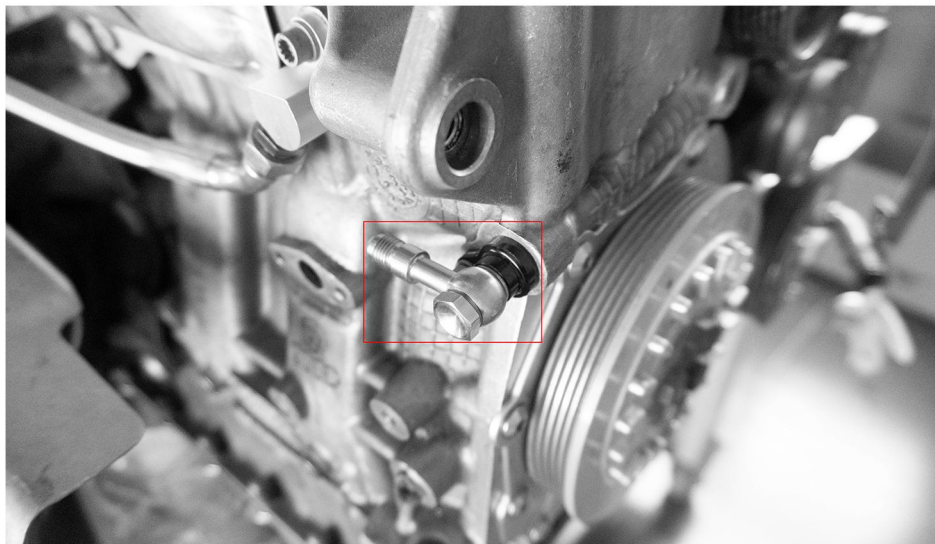

38. Install the JDY oil inlet Flange supplied to Cylinder Block and install the JDY Flange washer using OEM Bolts with Torque supplied at 10NM

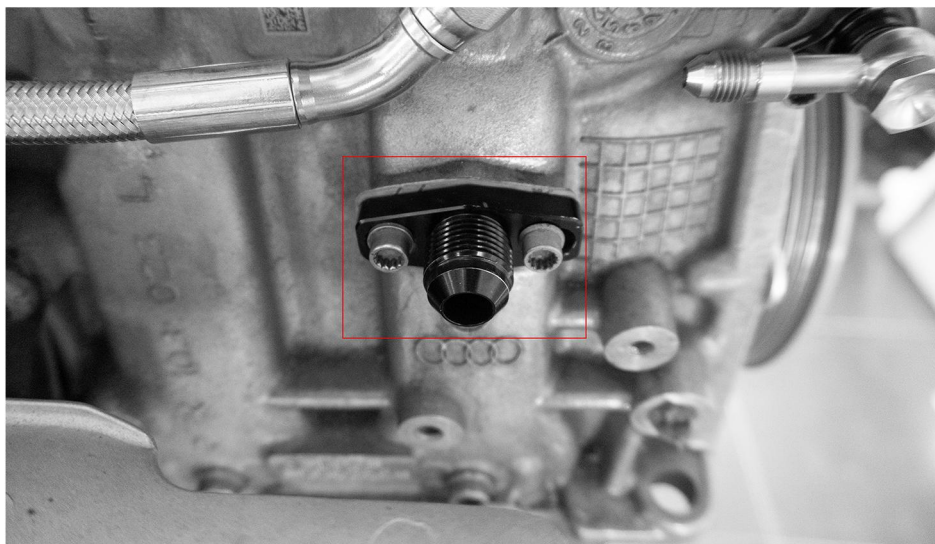

39. Install the JDY Exhaust Manifold



40. Fix the JDY Exhaust Manifold with Nuts supplied by JDY using 12mm Socket

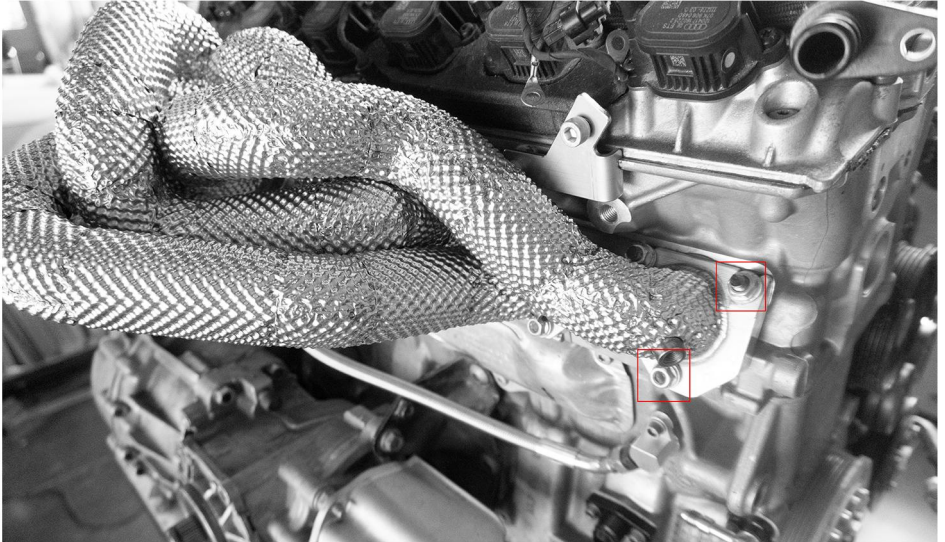

41. install the Nuts with hands, pre-torque in order from 1-12

Torque applied at 25NM to get it fully fixed using Torque Wrench for two rounds

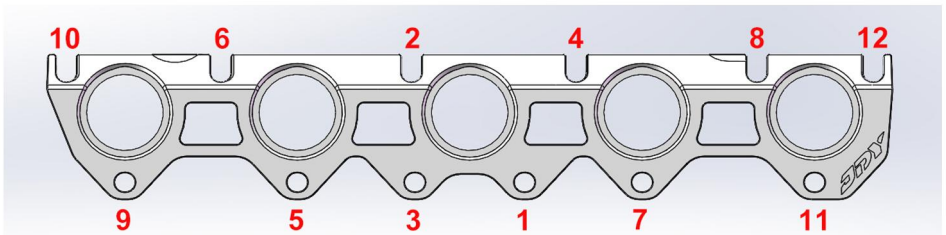

42.install the bolts(two different ones from OEM andJDY) on JDY Heat Shield with M10 and H6 Sockets

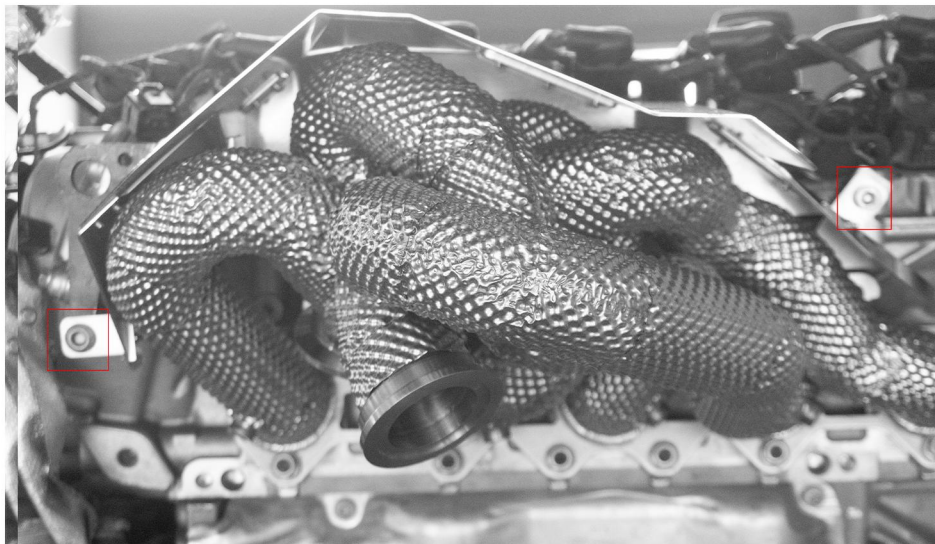

43.Install the JDY 1/8NPT to AN4 Fitting onto the Turbo Oil Inlet Port with 13mm Socket

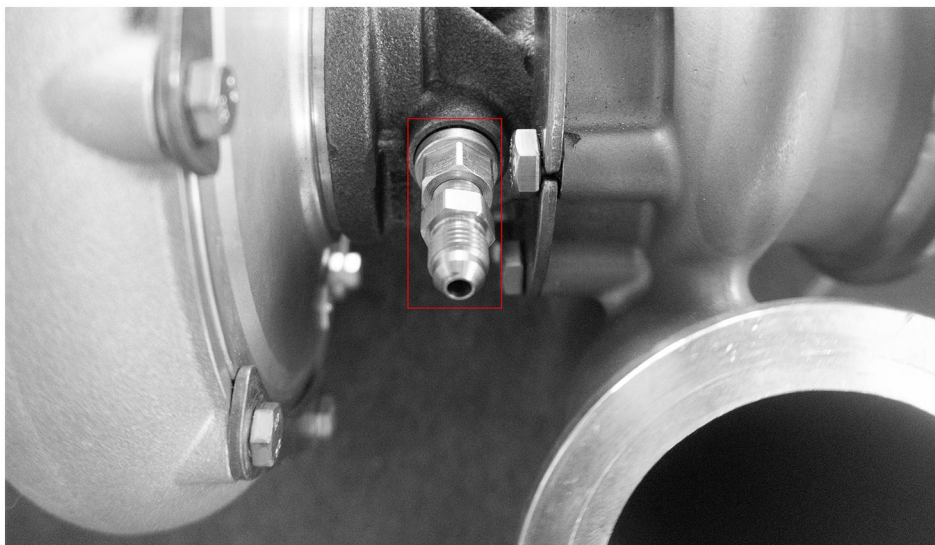

44.install turbo oil outlet lfange, flange seal, flange whasher, and flange fastening bolts (torque 20nm)



45:Fasten the bolts on JDY Intake manifold and Turbo Clamp with 13mm Socket (Make sure the turbo's put at the right place adjustable. With everything being set in place, then it's time to fasten the clamp bolts with torque applied at 15NM)

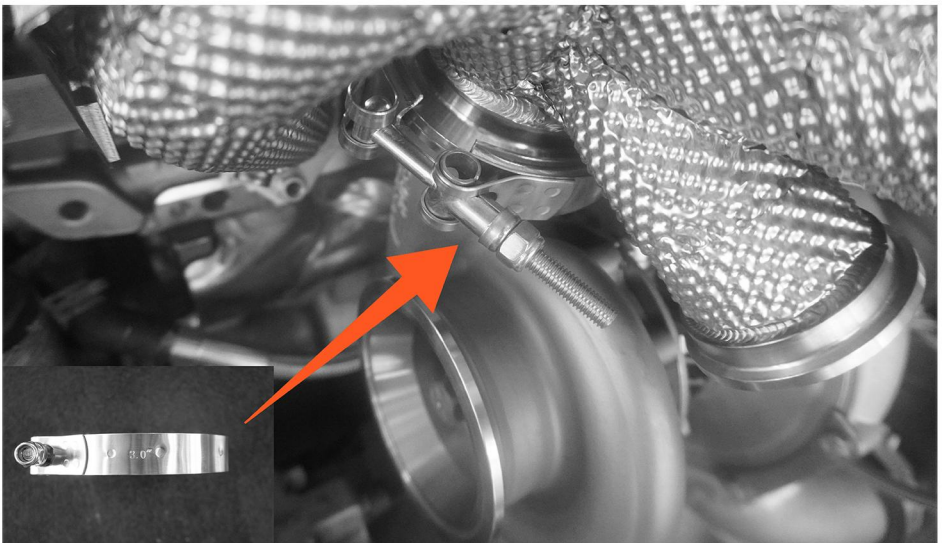

46. Install the JDY Oil Return Line with Wrench
(Oil Return Line angled 60° on the Turbo, , Oil Return Line angled 120° on the block"

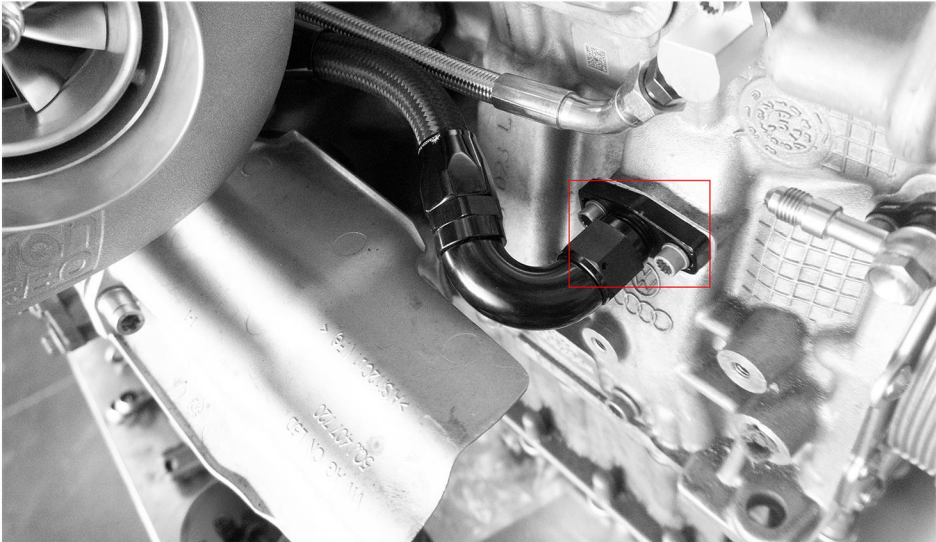

47. Install the JDY Oil Return Line with 14mm Wrench
(install Oil Return Line angled 90° , AN4 Fitting to Turbocharger, install Oil
Return Line angled 45° to the engine Block)"

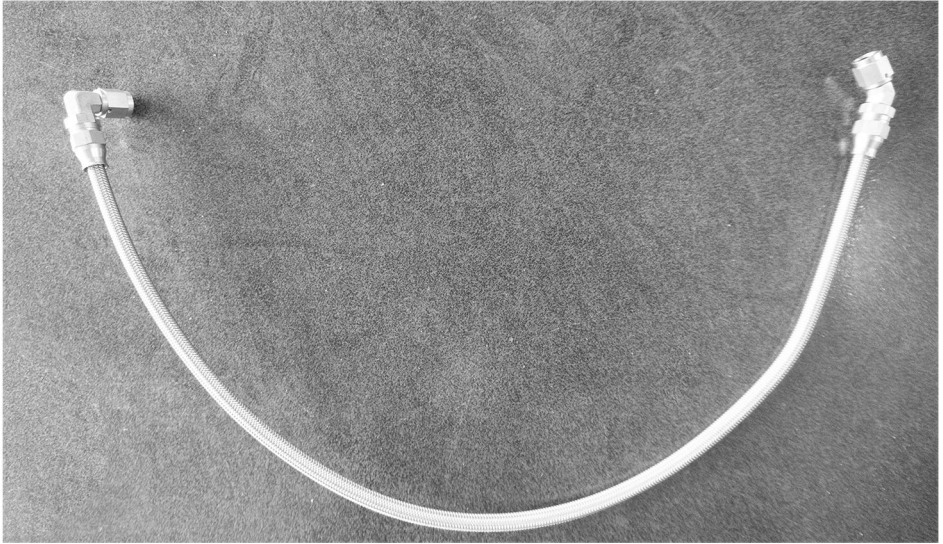

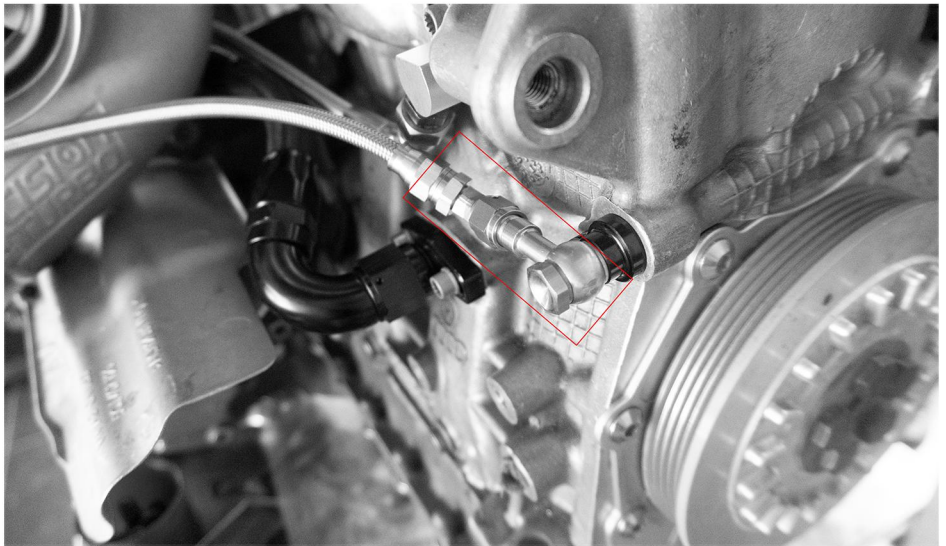
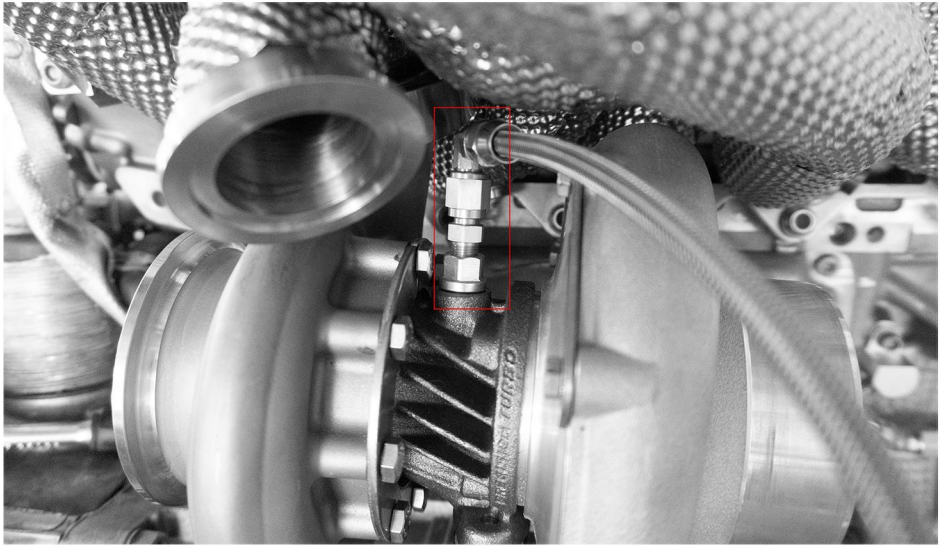

49. Remove the OEM Turbo Charge Aluminum Pipe Bracket with T30 Socket

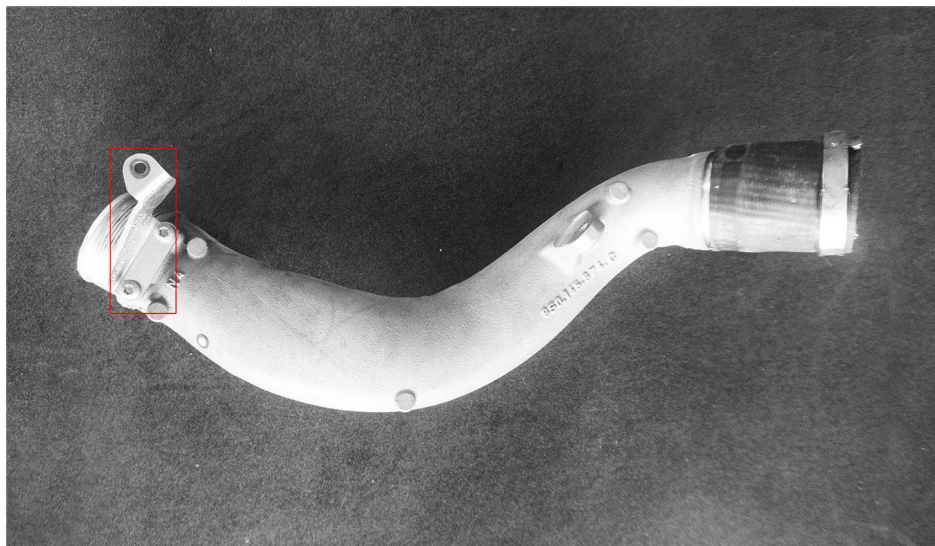

50. Install the OEM Bracket on the JDY Turbo Charge Aluminum Pipe with T30 Socket

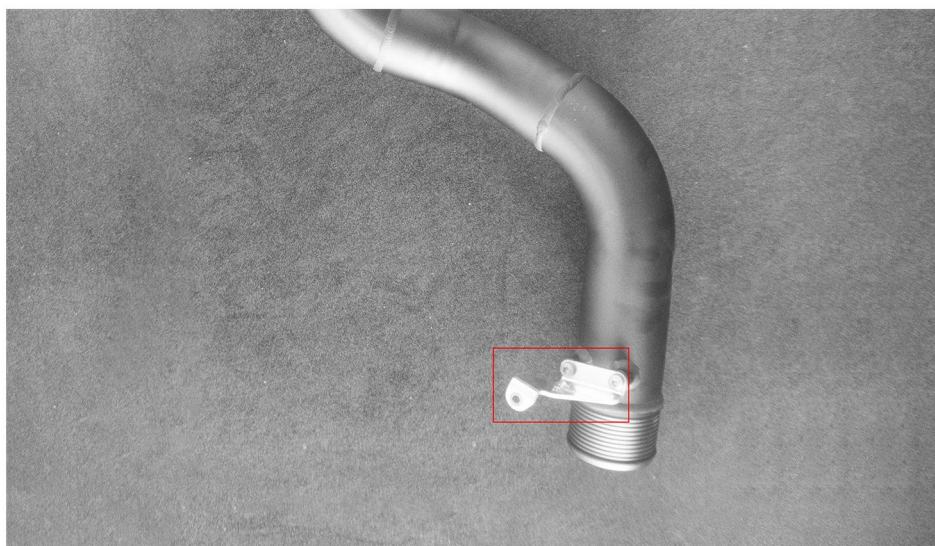

51. Connect the JDY Turbo Charge Scilicon Pipe with 7mm Socket

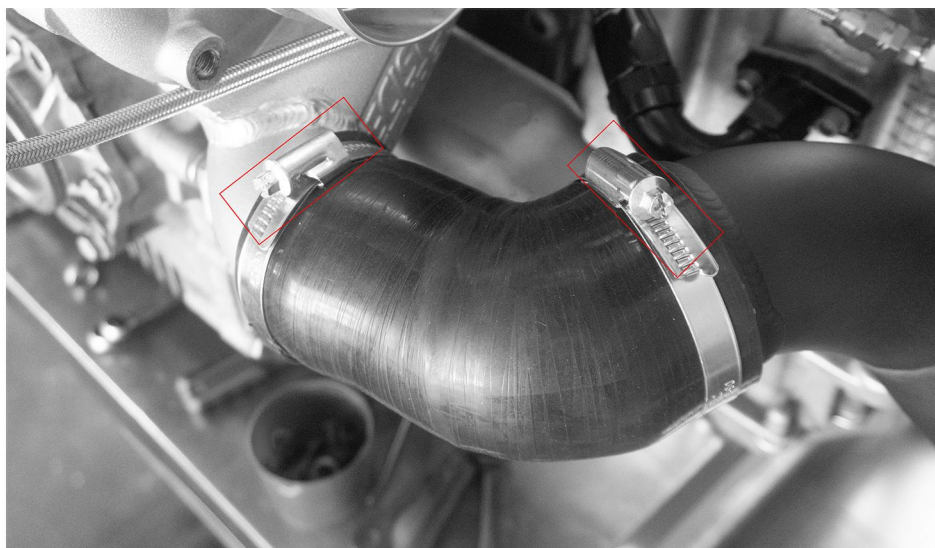

53.install the Bolts from OEMCharge Aluminum Pipe Bracket with T30 Socket

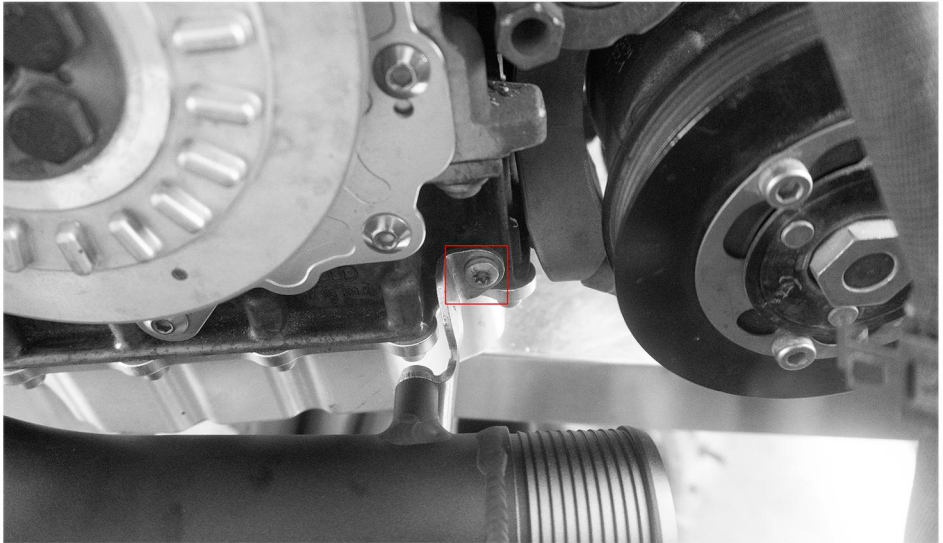

54.Fasten the bolts on the MVR and Exhaust Manifold with H4 Socket
(Make sure the MVR's put at the right place adjustable. With everything being set in place, then it's time to fasten the clamp bolts with torque applied at 10NM)

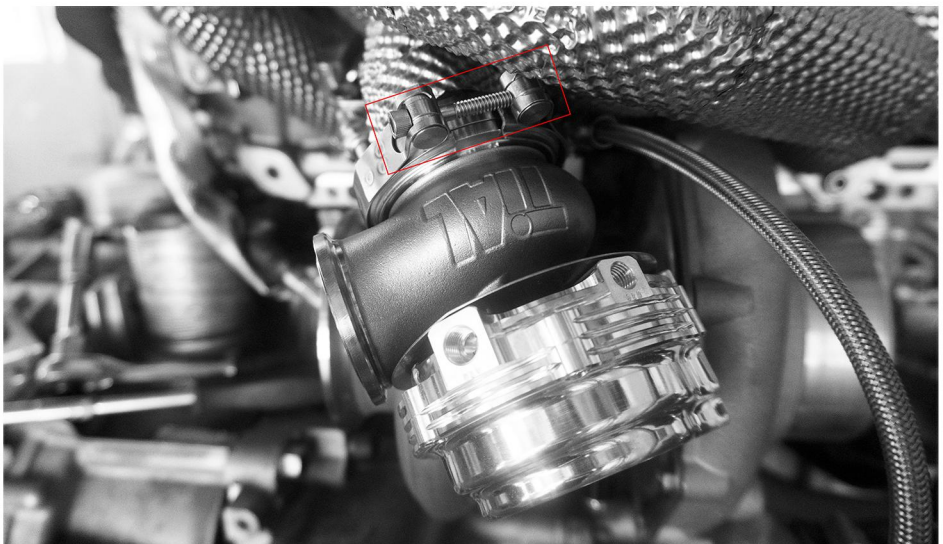

55:Fasten the bolts on JDY Intake manifold and Turbo Clamp with 13mm Socket
(Make sure the downpipe's put at the right place adjustable. With everything being set in place, then it's time to fasten the clamp bolts with torque applied at 15NM)

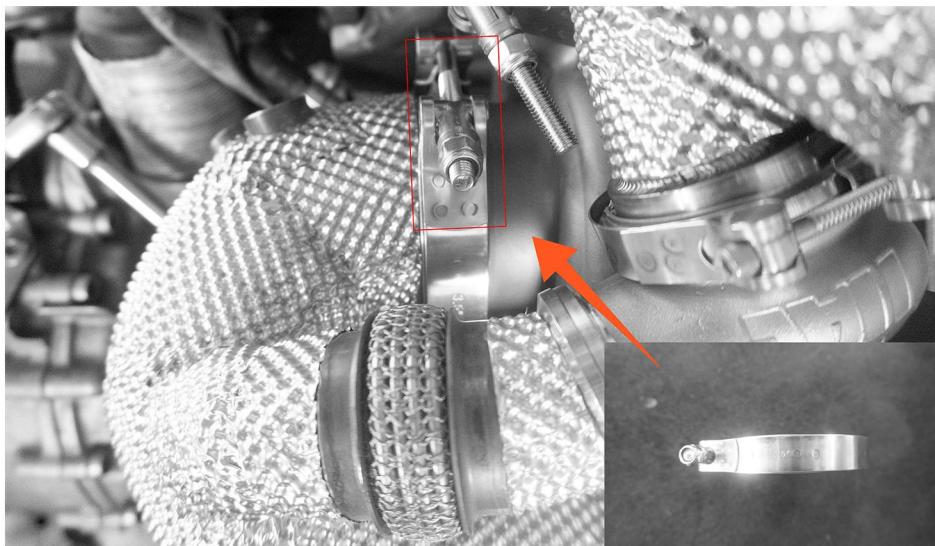

56:Fasten the MVR and Downpipe Clamp Bolts with H4 Socket
(Adjusting both of the turbo and downpipe in every direction possible to the stage where there's no clearance in between. Then fasten all the bolts on turbo, downpipe and MVR clamp with torque applied at 10NM)

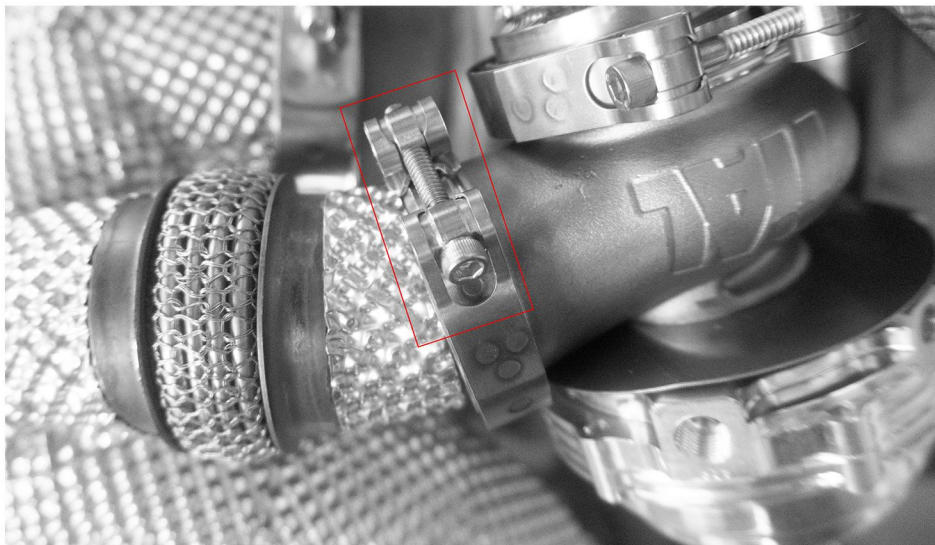

58:Fasten the bolts on the downpipe and midpipe clamp with torque applied at 15NM

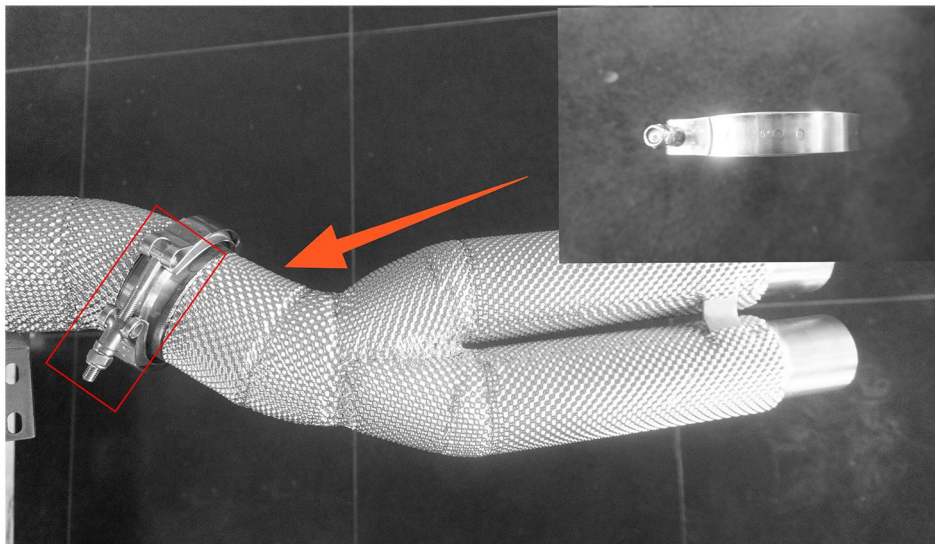

59: Fix the intake aluminum pipe onto the compressor cover inlet using clamp bolts supplied by JDY with H4 Socket

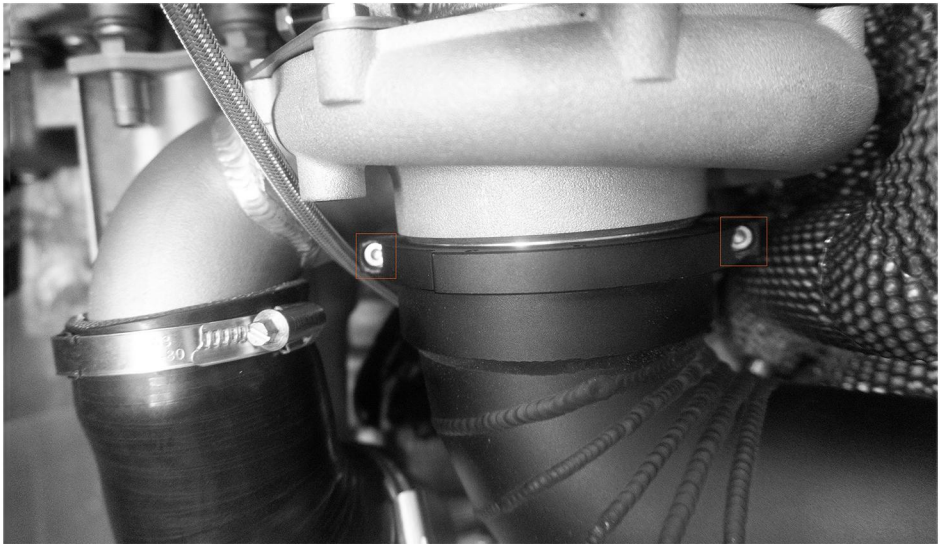

60.install the JDY bolts on the OEM EGR(Exhaust Gas Recirculation)Pipe with H5 Socket

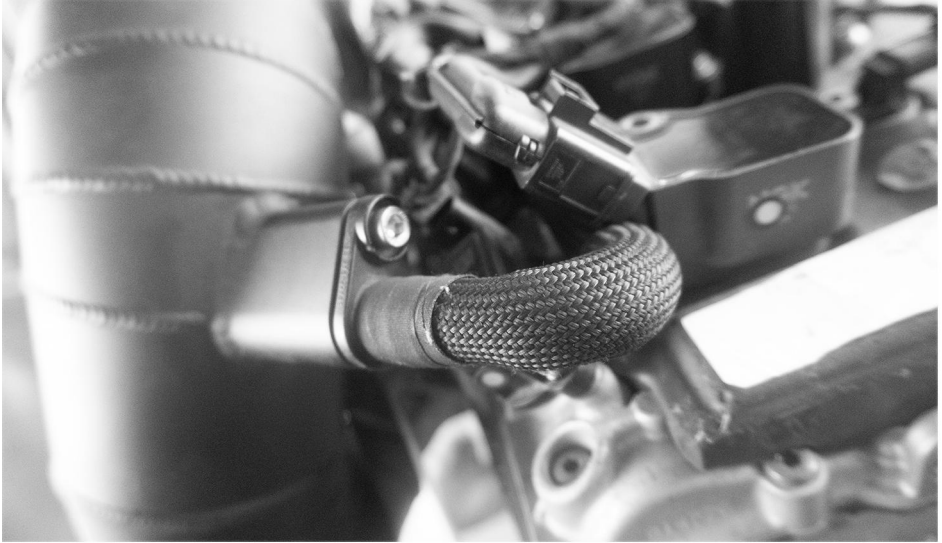

61.The process has come to an end

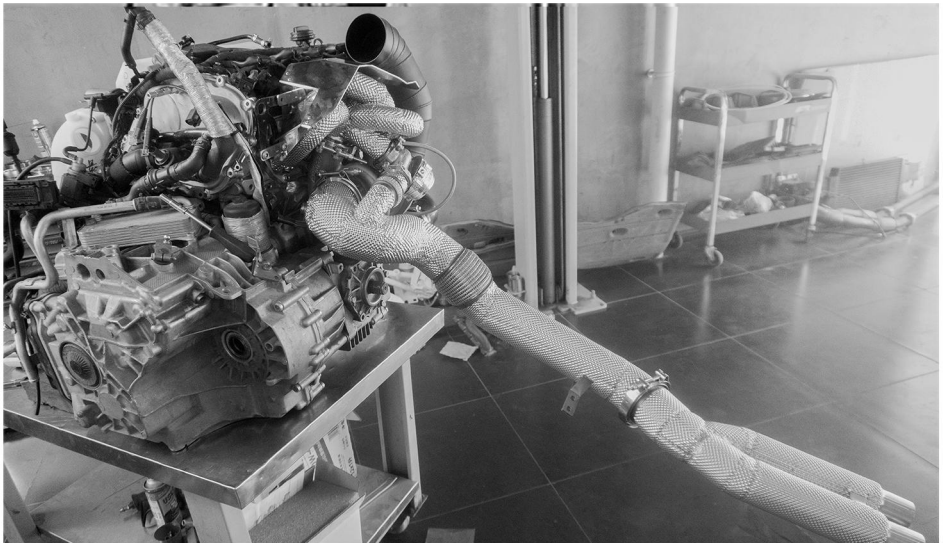

**THANK YOU VERY MUCH FOR PURCHASING
JDY PERFORMANCE PRODUCTS!**

If any further assistance is needed please contact :

tech@jdyperformance.com

sales@jdyperformance.com

or you can always contact us through our facebook & instagram official page



WWW.JDYPERFORMANCE.COM