

TANDBERG

TR 2080 AM/FM STEREO RECEIVER

Operating instructions

Contents

	Page
Power On-Off switch	3
Extra power sockets	3
Light dim	3
Antenna connections	4
FM Antennas	4
Tuning on FM	6
AM Antennas	8
Grounding	8
Tuning on AM	9
Volume - Balance	9
Tone Controls	9
Filters	10
Stereo - Mono switching	10
Loudspeakers	11
Speaker selector	12
Headphones	13
Output power reading	13
Listening to records and tapes	14
Recording from the receiver	15
Recording from a transcription unit	15
Copying tape	16
Program testing (monitoring) during recording	16
Combined record/playback	17
Use of the Output Preamp.- and the Input Poweramp.- sockets	18
Recording a tone-corrected program via Tape 2 socket	18
4 Channel use	19
Plugs	20
Useful data	20



ENGLISH

Tandberg
RADIO

For your safety!

To prevent electrical shock or fire, do not expose electronic products to rain or moisture and do not remove covers (or back). If anything fails, leave the repairs to a qualified technician.

Pull out the power plug and aerial plug during thunder-storms and when you are away for a long time (e.g. holidays, etc.).

Specially for the United Kingdom:

IMPORTANT! The wires in this mains lead are coloured in accordance with the following code:

BLUE:	NEUTRAL (N)
BROWN:	LIVE (L)

If the wire colours in this mains lead do not correspond with the terminal identification of your plug, connect as follows:

Blue wire to terminal coded **N** or coloured **Black**.
Brown wire to terminal coded **L** or coloured **Red**.

Do not make any connection to the larger terminal coded **E** or coloured **Green** or **Green and Yellow**.



This product has been specially constructed to perform as 3 separate components – tuner, preamplifier, and power amplifier – built on one chassis. No single element has been favoured more than another to make this a complete and integrated system.

In every respect it has been provided with all the basic requirements for a sophisticated Hi-Fi product. The FM section has the finest quality possible. The preamplifier is oriented to the serious collector of discs and tape recordings. The power amplifier has been built with considerable attention to eliminating transient intermodulation distortion, and is conservative rated. The specifications accompanying the product define its performance technically. We have as well taken special efforts to evaluate and perfect the unit according to listening tests. These test show that it is possible to hear a qualitative difference between this receiver and other products on the market.

Power switch

Make sure that the receiver is marked with the correct a.c. voltage for your supply.

Switch the receiver on by depressing the Power button. Another push on the button will release it and switch the receiver off. This button also controls the power to one of the extra power sockets, marked Switched, at the back of the receiver (more details below).

NOTE! When switching on you will notice that nothing happens until about 6 seconds after you have pushed the Power button. Then you will hear a click from inside the cabinet and the receiver becomes live smoothly without audible switching transients in the speakers.

Extra power sockets

NOTE! Applies to the units intended for US market only.

Three extra power sockets are provided at the back of this receiver. These extra sockets are intended for other Hi-Fi units and reduce the number of untidy power cables.

Two of the sockets by-pass the Power button and are live as soon as the receiver power plug is live. These sockets are marked Unswitched and the total combined power drawn from them must not exceed 200 W. These sockets are useful for connecting Hi-Fi units having their own power switches.

The third extra power socket is marked Switched and is controlled by the Power switch on the receiver. This socket is suitable for a Hi-Fi unit that does not have its own power switch and the total power drawn from it must not exceed 100 W.

Check the power consumption of the units you connect to these extra sockets to ensure that it falls within the permissible total rating.

Light dim

If the scale and meters light are too bright, depress the Light Dim button on the extreme right side of the receiver. Another push on this button will restore the lights to full brightness.

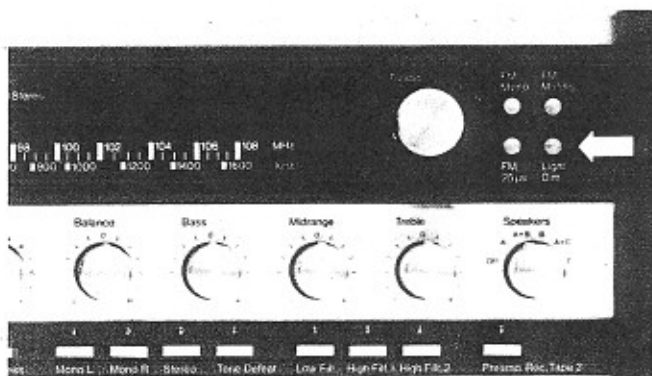
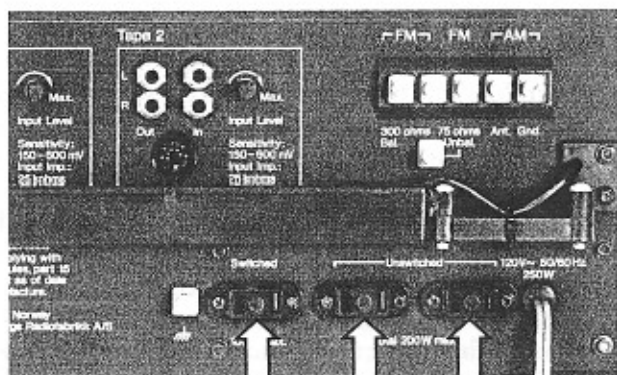
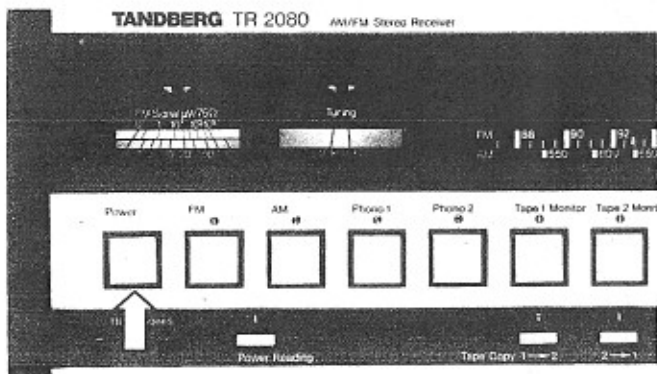

Antenna connections

This receiver is equipped with a balanced antenna input and an unbalanced antenna input.

The 300 ohm balanced input terminals (socket on European version) are intended for connection to a 300 ohm antenna via a flat twin-lead balanced feeder having the same impedance.

The 75 ohm unbalanced input terminals (socket on European version) are intended for connection to an antenna via a 75 ohm coaxial cable. The center conductor of the cable should be connected to the terminal marked 75 ohms and the shield should be connected to the chassis terminal just below.

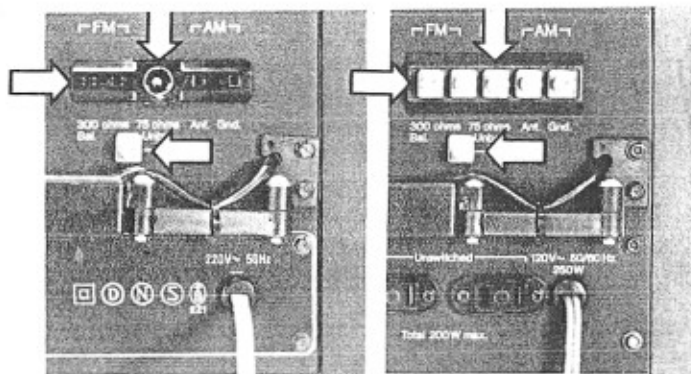

Standard model

US model

FM Antennas

What type of antenna do you need?

Your need for a good antenna will depend on the receiving conditions where you live; the further you are away from the transmitter and the more obstacles (hills and tall buildings for example) between you and the transmitter, the greater will be your need for a good antenna. Remember that it is not good enough just to receive a signal, especially if you are a serious listener. You need to receive a signal that is much stronger than any unwanted electrical noise that might be lurking around in your area. Furthermore, FM signals bounce off large obstacles and cause you to receive the same program from several directions at the same time, possibly out of phase with one another. This gives distortion which you do not want. Instead you need one strong, clear signal straight from the transmitter and this may call for an elaborate, directional antenna.

If in doubt you can consult your dealer who will probably be more familiar with local receiving conditions than most people. In any event you should install an antenna that is better than the one that you think you can just manage with, because under doubtful conditions a good antenna is just as important as good loudspeakers.

Whether you need a simple antenna such as a folded dipole or an elaborate multi-element array, the following tips will be useful.

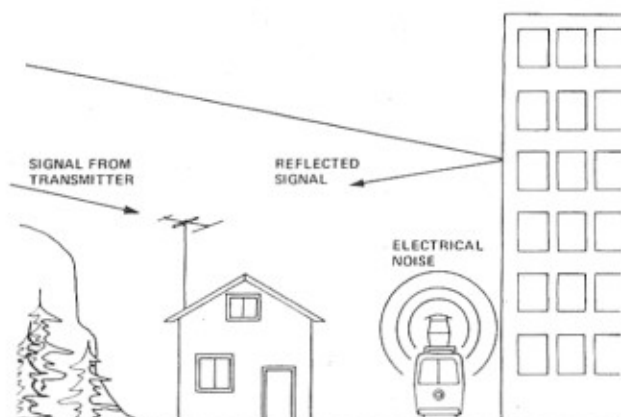

The antenna should be mounted in such a way that you receive the signal straight from the transmitter without picking up reflected signals or electrical noise.



A simple folded dipole antenna

A simple folded dipole for connection to the balanced input can be easily made from flat twin-lead with an impedance of 240 to 300 ohms. A 135 cm (53") piece of antenna lead should be used for the loop. Strip off approximately 1 cm (½") of insulation at each end and solder as shown. Cut one of the wires in the middle of the loop and connect another twin-lead to act as feeder to the input. Solder as shown.

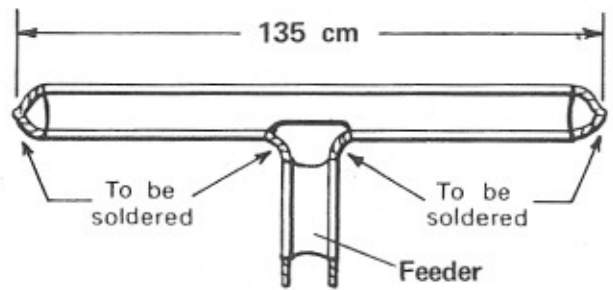

A simple folded dipole

This antenna can be used indoors or outdoors. When used outdoors the solder joints should be protected against the weather and the loop can be fixed to a flat wooden board. When used indoors the loop can be fixed to any convenient non-metallic structure or a flat wooden board. The important requirement in all cases is that the loop should be firmly fixed, horizontal, and straight.

To obtain good reception the loop should be approximately at right angles to the transmitter (see diagram) although the best orientation may have to be found experimentally.

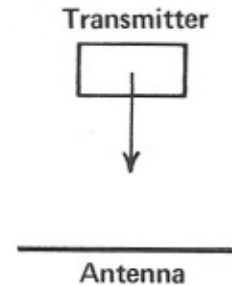

Typical multi-element antenna

The diagram shows a typical multi-element antenna for use where receiving conditions are doubtful. This type of antenna will provide a signal which is 3-4 times as strong as the signal from a folded dipole.

Many types of multi-element arrays are available and some can even be rotated every time you tune in to a different station. Your dealer will advise you or you can buy specialist literature and become an expert yourself.



Combined antenna

A convenient type of antenna is a combined multi-element FM antenna and a whip antenna for AM. The feeder should be a coaxial cable.

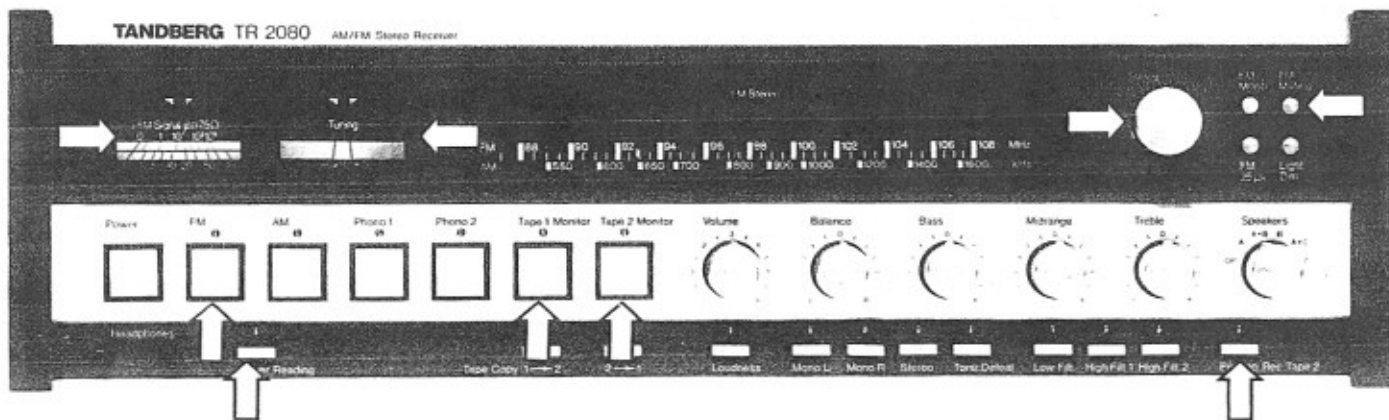

Make sure that the buttons Tape 1 Monitor, Tape 2 Monitor, Power Reading, and Preamp Rec Tape 2 are released.

Select FM reception by depressing the FM button. The red light over the button will light telling you that the receiver is in the FM mode.

Use the large knob on the right side of the scale to tune in the required station.

Correct tuning is important, particularly for stereo, if distortion is to be avoided. This receiver is therefore equipped with two tuning meters, one indicating signal strength (FM Signal) and the other indicating midscale for exact tuning (Tuning). First adjust the tuning knob for maximum deflection on the FM Signal meter and then make a final fine adjustment to obtain midscale deflection on the Tuning meter.

The frequency calibration of the scale is accurate to within ± 200 kHz. So do not be confused if a station transmitting on, for instance 92.9 MHz tunes in at 93.1 MHz on the scale. This is still within the tolerance. The scale is simply a guide and what really matters is that you use the two tuning meters correctly.

Muting

The high amplification necessary to obtain good sensitivity and limiting in high class tuners, makes tuning noisy. To avoid this, a muting circuit blocks the receiver automatically when no signal is received or if the signal is too weak to give satisfactory noise suppression. To receive a station that is not strong enough to cancel the blocking effect of the muting circuit, the circuit can be switched off.

Depress the FM Muting knob on the extreme right side of the front panel to activate the muting. Push the button again to release it and cancel the muting.



FM Stereo

This receiver is fully equipped for the reception of FM stereo broadcasts.

FM stereo broadcasting is based on the pilot tone system which allows the program to be received in mono on mono receivers without impairment of program quality. It is an inherent property of this system that a stronger signal is needed in stereo to obtain the same noise suppression as in mono. The FM stereo decoder automatically switches to stereo operation when a stereo signal of sufficient strength is received. If the stereo signal falls below a preset threshold, the program will be automatically reproduced in mono.

However, it is possible for the strength of a stereo signal to be adequately and yet for the signal to be temporarily disturbed by noise or distortion. In this event depress the FM Mono button whereby the program will be reproduced in mono without noise or distortion.

Because stereo reception requires a strong antenna signal and is sensitive to multi-path distortion, a good antenna is needed particularly under difficult receiving conditions and in fringe areas. Read the preceding section on FM antennas.

NOTE! If you receive a program transmitted via a stereo transmitter, the FM Stereo lamp will light even if the program is transmitted in mono.

Dolbyized* FM programs

A number of radio stations in the US are using the Dolby B** noise reduction system to reduce transmission noise on FM programs. Several European countries are also experimenting with the same system on FM programs and regular transmissions could begin at any time.

To get the best results when receiving a Dolbyized FM program you need:

- A 25 μ s correction network. This network is built-in on the TR 2080.
- A Dolby decoder. Such a decoder is built-in on Tandberg tape recorders with Dolby noise reduction system.

- Plug the tape recorder into the socket marked Tape 1 at the back of the TR 2080.
- Press in the buttons FM and Tape 1 Monitor on the TR 2080. In addition, press in the button marked FM 25 μ s (to the right on the front panel).

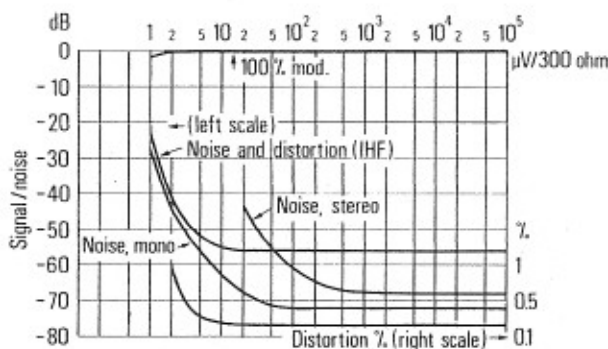

Signal/noise ratio and distortion curves for the FM section against antenna volts

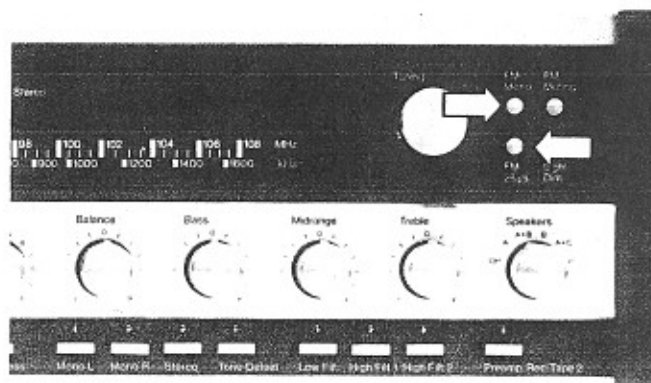

- Set the controls on the tape recorder as follows: REC SELECT buttons in, DOLBY N.R. switch to DOLBY FM, SOURCE/TAPE buttons out, OUTPUT LEVEL knobs to 6.
- Adjust the LINE INPUT LEVEL knobs so that the test tone which is transmitted before the program begins causes the level meters on the recorder to reach the 50% mark.

If you press the RECORD button the program will also be recorded.

NOTE! Dolbyized programs can also be received without using a Dolby decoder. The button marked FM 25 μ s should then be out. All Tandberg receivers also have the correct standard built-in de-emphasis (75 μ s or 50 μ s) required for each particular market.

* The words "Dolby" and "Dolbyized" are registered trademarks of the Dolby Laboratories Inc., US.

** Must not be confused with the Dolby A system used for professional recordings in sound studios.

Ferrite-rod

For operation in the broadcast band this receiver is equipped with a moveable ferrite-rod antenna. This antenna is intended for local reception where the signal strength is normally fairly high, but it can under favorable receiving conditions also pick up more remote stations efficiently. The ferrite-rod antenna is highly directional and picks up the strongest signal when it is at right angles to the transmitter. The antenna is hinged and should be rotated to the position giving the best reception. This is also possible when the receiver is placed on a shelf. The ferrite-rod antenna can never perfectly replace a good outdoor antenna.

NOTE! The antenna circuit is built into the ferrite-rod casing. When listening to AM you should always move the ferrite-rod away from the rear panel to avoid de-tuning the antenna circuit. This is also important when using an outdoor antenna.

Outdoor antenna

To give the best results an outdoor antenna should be used. Suspend a wire 10 to 20 meters (30 to 60 feet) long at the highest possible elevation. The best results may be obtained by experimentation.

Connect a feeder to the terminal marked AM Ant (socket on European version) and if the feeder is long avoid running it too close to walls.

If you have the European version connect the appropriate plug.

Combined antenna

A convenient type of antenna is a combined multi-element FM antenna and a whip antenna for AM. The feeder should be a coaxial cable.

Grounding

To obtain best AM reception grounding of the receiver is recommended. Connect the AM ground terminal (A) to the nearest water pipe.

The grounding terminal B is designed for FM coaxial antenna cable (US model only).

The grounding terminal C is for grounding a transcription unit or record player chassis when phono plugs are used. Wiring for the DIN plugs is shown on the back cover.

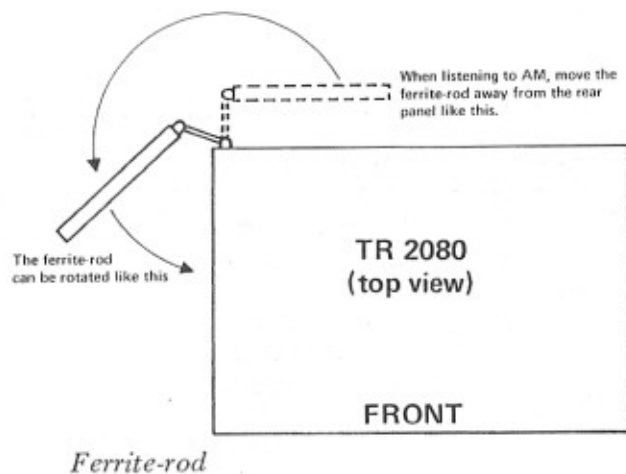

Ferrite-rod

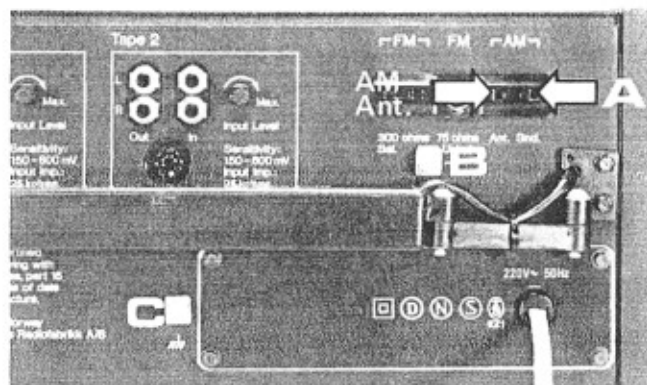
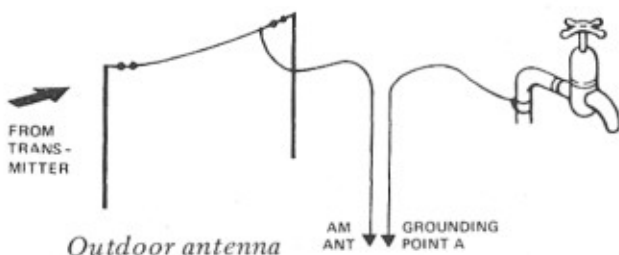

Standard modell

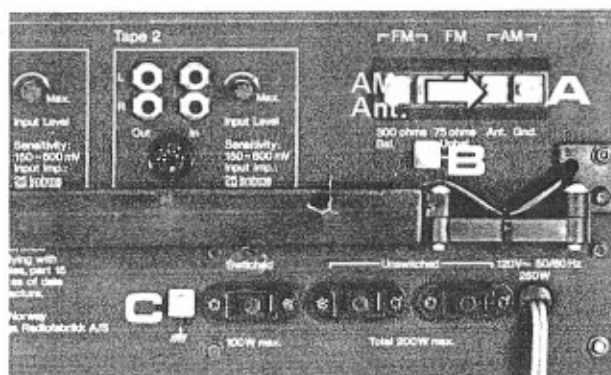

U.S.A. modell

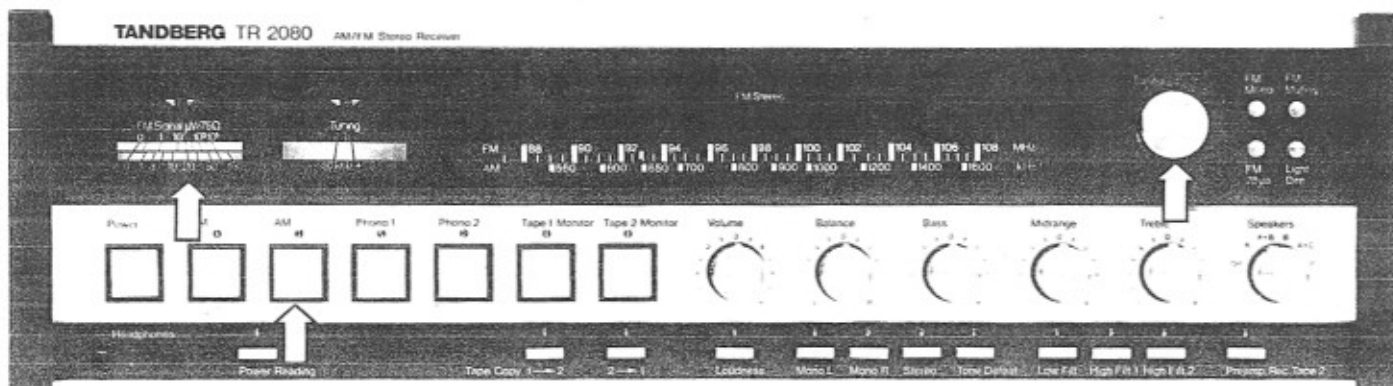

Make sure that the buttons Tape 1 Monitor, Tape 2 Monitor, Power Reading, and Preamp Rec Tape 2 are released.

Select AM reception by depressing the AM button. The red light over the button will tell you that the receiver is in the AM mode. Use the large

tuning knob on the right side of the scale to tune in the required station. Tune for maximum deflection on the FM Signal meter.

Volume – Balance

Use the Volume knob to control the audio power fed to the loudspeakers.

Use the Balance knob to control the relative output levels from the two speaker channels.

A typical use for the Balance control is to compensate for differences in characteristics or the speaker positioning of left and right speakers.

Tone Controls

This receiver is equipped with three independent tone controls for controlling the Bass, Treble, and Midrange audio frequencies. The effects that can be achieved when the three controls are used may be seen in the graph.

The knobs are the split type where the inner part of the knob is for the right channel and the outer part of the knob is for the left channel.

Tone controls can be used to achieve a tone picture that is pleasing to the individual listener. They can also be used to compensate for lack of "body" in any particular tone region with a program from any source. A further use for tone controls is to compensate for speakers and/or room acoustics that do not give the desired tone picture.

NOTE! The tone controls will only work when the Tone Defeat-button is released (out). See next paragraph. See also the paragraph on filters on page 10.

Tone Defeat

Press the Tone Defeat button to override the tone controls and obtain a level frequency response.

NOTE! The Loudness and filter functions are not affected by the position of the Tone Defeat button.

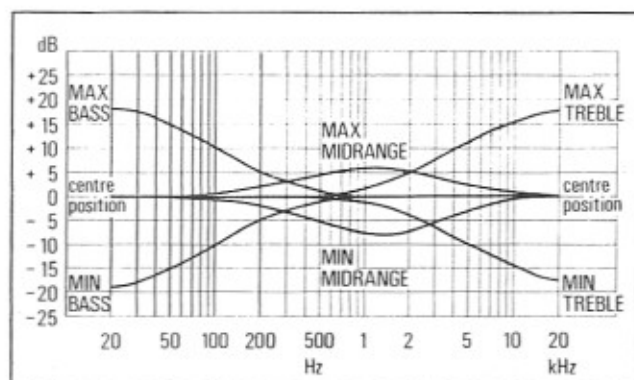

Effect of the tone controls

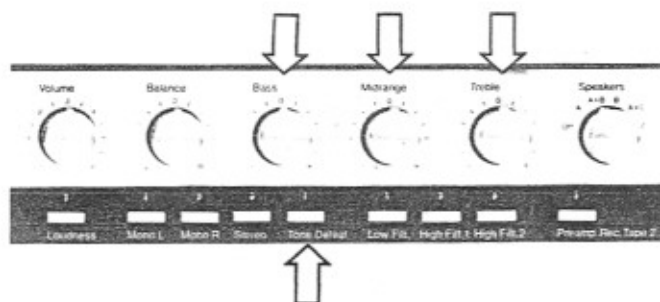

Low Filter

Rumble from a record player, acoustic feedback between speakers and a pick up, or excessive bass resonance in a speaker or a room can all be controlled by means of the Low Filter. The graph shows the effect of the control (-12 dB/octave).

High Filter 1

If the program is accompanied by strong hiss or scratch noises from old and worn records or noise from a tape recorder or from the receiver, depress the High Filter 1 button to obtain moderate attenuation of the high frequencies. The graph shows the effect of the control (-12 dB/octave).

High Filter 2

This control can be used for the same purpose as the High Filter 1 control, it simply gives less attenuation (-6 dB/octave) as may be seen in the graph.

High Filter 1 and High Filter 2

Depressing both these buttons simultaneously gives the heaviest attenuation of all at the high frequencies as may be seen in the graph (-18 dB/octave).

Loudness

At low volume the ear is less sensitive to high and low tones. As a result music at low volume from

speakers tends to lack high and low tones and sounds as if it has too much "body" in the middle tone range. To compensate for this effect, depress the Loudness button whereby the bass and treble will be boosted according to the setting of the Volume control. The graph shows how this boost increases as the volume is turned down.

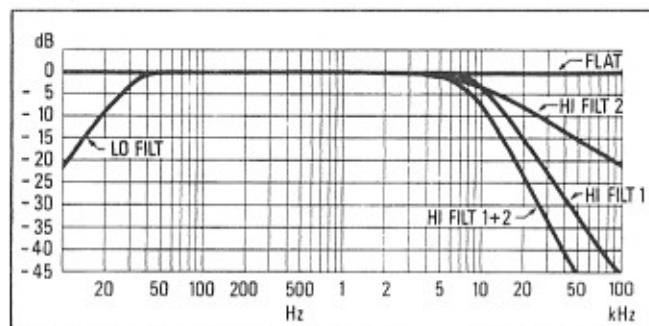

Effect of Low and High filters

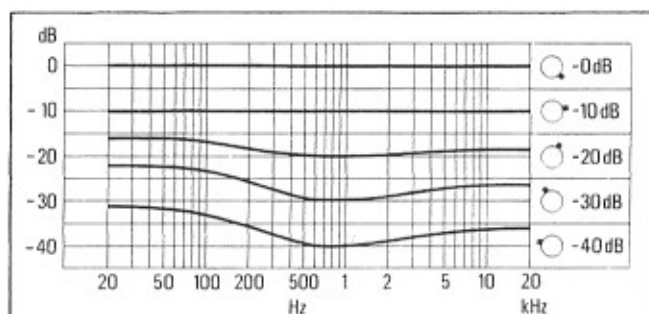

Effect of Loudness control for different Volume control settings

Stereo – Mono switching

The amplifier section can be connected for stereo or mono reproduction. There are 5 modes of operation:

Stereo button in: the two channels are separated – normal stereo reproduction.

Mono L button in: the left channel of the program source is connected to the left channel and the right channel in the amplifier.

Mono R button in: the right channel of the program source is connected to the left channel and the right channel in the amplifier.

Mono L, Mono R, and Stereo buttons in simultaneously: the two channels are separated and crossed over.

Mono L and Mono R buttons in (or all buttons out): the right and left channels of the program source are combined and connected to both channels in the amplifier (full mono).

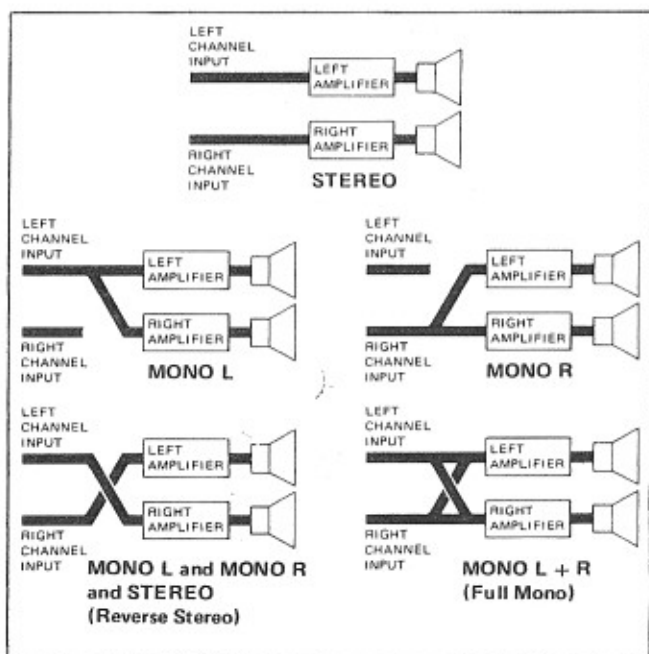

Connections

Connect speakers to the terminals marked Speakers at the back of the receiver. Use multi-stranded wire as thick as possible and make firm connections. The receiver will deliver optimum undistorted power when the resultant impedance of all the speakers connected to *each stereo channel* is between 4 and 8 ohms. Speakers or combinations of speakers with higher or lower impedances will give output powers below the optimum. For load impedances below 4 ohms the output power drops rapidly (see curve).

Polarity

Whichever combination of speakers is used it is important to observe the polarity when speakers are in the same room. In other words the cones must move forwards and backwards together. If the polarity is wrong, one cone will be moving forwards when the other is moving backwards and the result will be a reduction in bass volume. The polarity will usually be correct when each terminal marked with a minus sign (–) on the rear panel of the receiver is connected to the terminal marked COMMON (or NEGATIVE) on each respective speaker. However, reversals of polarity can occur in the wiring between the receiver and the speakers or even occasionally inside the speaker cabinet. One way to be certain is to check the bass volume (under mono conditions with speakers facing each other about 6 inches apart) and reverse any wrong connections.

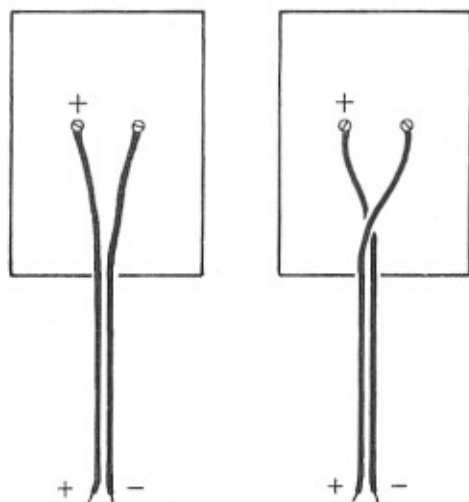
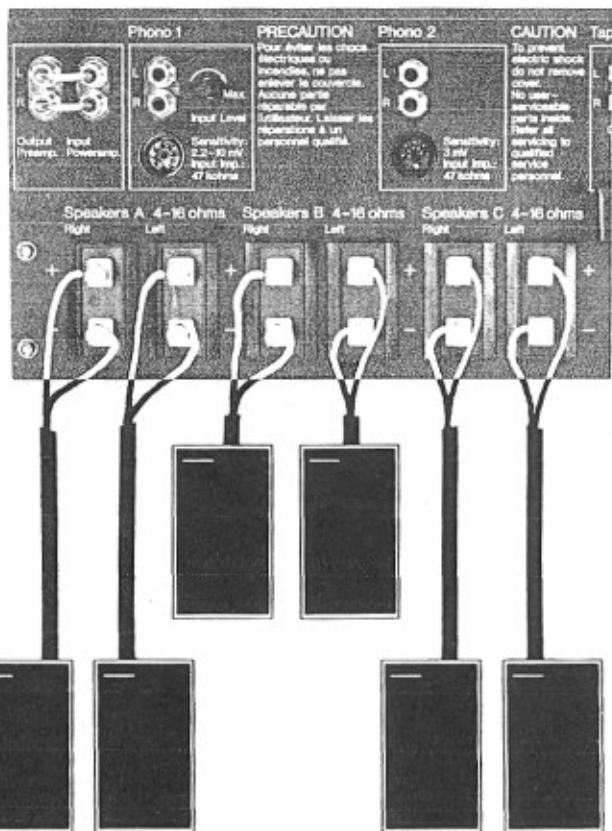

Crossed connections will give bad bass reproduction

Speaker combinations

The top figure shows some possible speaker combinations for *one stereo channel*. Each channel has 3 outputs in parallel, A, B, and C. But only 2 of the outputs (A + B or A + C) can be switched in at the same time. So when calculating the resultant impedance you must take this into account.

What type of speaker?

This receiver has been designed for use with speakers having a wide range of phase angles i.e. electrostatic as well as moving-coil systems. A good all-round type of loudspeaker which is reliable in design, manufacture, and use is the totally enclosed infinite baffle type. Tandbergs produces a full range of this type of loudspeaker. Ask your dealer for details.

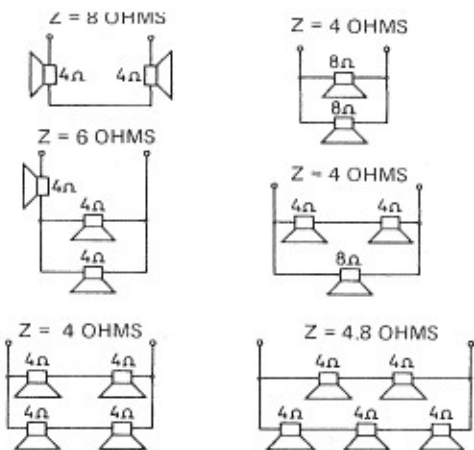

Speaker combinations for one stereo channel

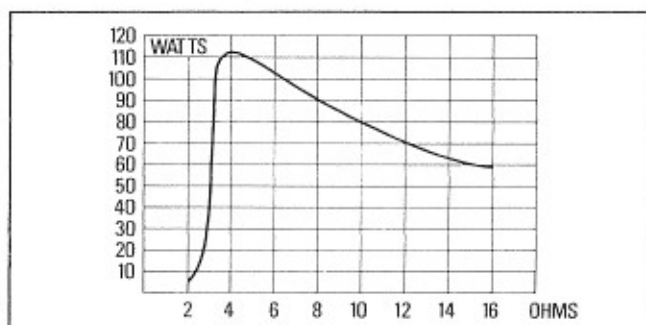

How output power to loudspeakers varies with total loudspeaker impedance

Speaker selector

The speaker selector switch marked Speakers has six positions as follows:

- OFF: All speakers disconnected.
- A: Program to speaker outputs A only.
- A + B: Program to speaker outputs A and B.
- B: Program to speaker outputs B only.
- A + C: Program to speaker outputs A and C.
- C: Program to speaker outputs C only.

In all positions of the speaker selector the program is also fed to the Headphones outputs.

NOTE! It is not possible to feed all three speaker outputs at the same time.

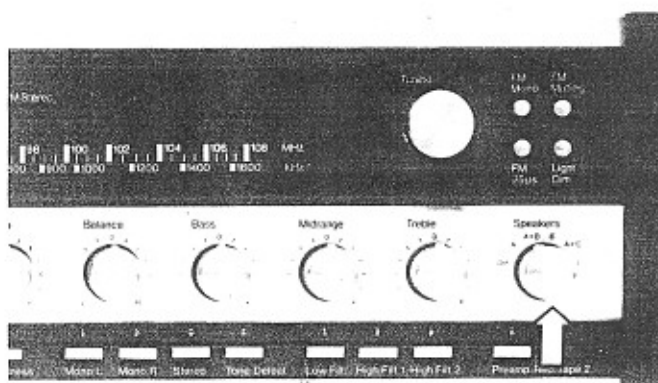

Headphones

Stereo headphones can be connected to the 3-pole jacks marked Headphones on the left side of the front panel and the program level can be adjusted by the Volume and Balance controls. Two people can listen at the same time if two sets of headphones are plugged in and you can avoid disturbing other people in the room by switching the knob Speakers to Off.

Headphone listening is very convenient for monitoring when recordings are being made, particularly if microphones and loudspeakers are in the same room because it avoids "acoustic howling".

Some people also prefer headphones when listening to music. They provide a more intimate listening experience and difficulties associated with room acoustics are avoided. But there are disadvantages, for example the whole sound environment turns with the listener when he moves his head, a feeling regarded by some people as unnatural. It is a matter of personal taste.

The impedance of the headphone jacks is 220 ohms and they will accept any headphones with an impedance above 3 ohms.

Remember to order headphones terminated in a 1/4" jack plug.

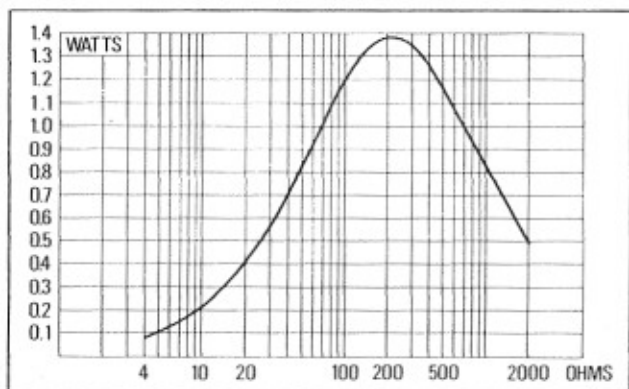
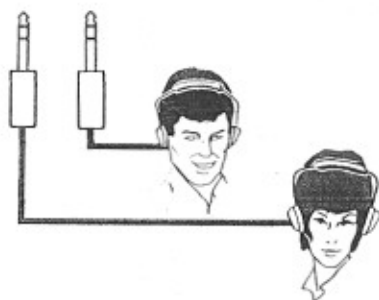
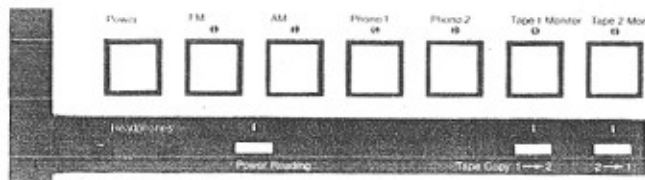

How the output power to headphones varies with headphone impedance

Output power indicator

Depress the button Power Reading on the lower left of the front panel to obtain an indication on the FM Signal meter of the audio power (in a 8 ohms speaker) being delivered to the speakers.

The meter is peak reading, and indicates output power for the left or right channel, whichever momentarily has the highest output. Maximum obtainable output power depends on the speaker impedance (load per channel). The table shows the relation between output power and meter reading at different load impedances.

The output monitoring function of the meter serves two purposes:

- To avoid overloading the output amplifier.
- To avoid overloading speakers not rated for the full output power of the amplifier.

NOTE! If the receiver is overloaded at too high ambient temperature (insufficient ventilation), a thermal switch will disconnect the amplifier. The amplifier will, however, resume normal operation as soon as the temperature inside the receiver has dropped sufficiently.

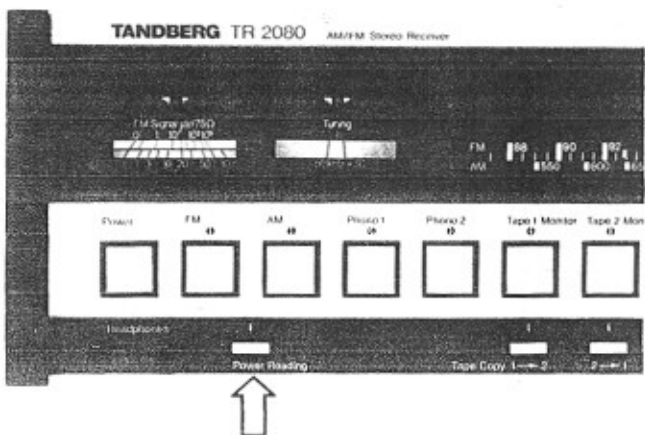

Load	Meter reading									
	1	3	6	10	20	30	50	70	100	
8 ohms	1	3	6	10	20	30	50	70	100	watts
4 ohms	2	6	12	20	40	60	100	140	200	watts
16 ohms	0.5	1.5	3	5	10	15	25	35	50	watts

Listening to records and tapes

OUT ON SONY
TO IN

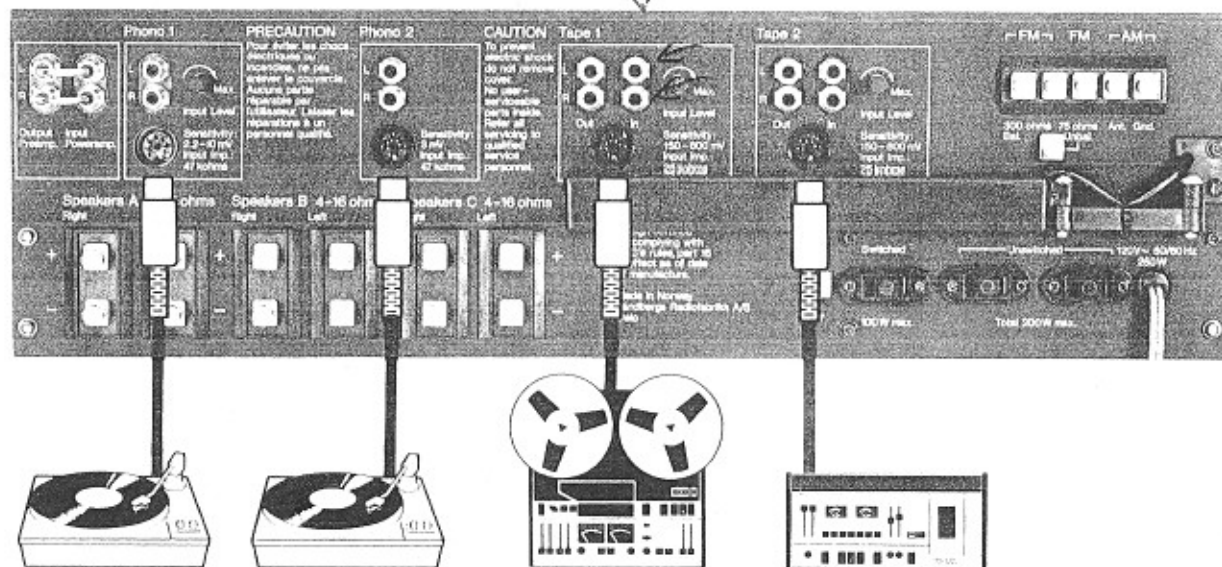

At the back of the receiver there are four sets of sockets. Two of the sets are for transcription units (marked Phono 1 and Phono 2). Each input has an impedance of 47 k ohms and the correct sensitivity for magnetic pick-ups.

NOTE! Make sure that the buttons Tape 1 Monitor and Tape 2 Monitor are out.

Two of the socket sets are for tape decks (marked Tape 1 and Tape 2). Two reel-to-reel machines or two cassette machines, or one of each type can be connected. Each input has an impedance of 25 k ohms which is suitable for most tape decks.

One transcription unit

To play records from one transcription unit, connect the transcription unit to the Phono 1 socket (using either phono or DIN plugs), start the transcription unit and depress the Phono 1 button on the front panel.

Two transcription units

Using two transcription units is particularly convenient when you are playing large orchestral or choral works spanning several records. You can then play one record after the other non-stop. This gives you facilities similar to those on a record changer.

Procedure: Connect the two transcription units to the Phono 1 and Phono 2 sockets, start the Phono 1 transcription unit and depress the Phono 1 button on the front panel. As the record ends, start the Phono 2 transcription unit and depress the Phono 2 button. With practice you will achieve timing which makes it possible to play two records without loss of continuity.

Of course you can then put a third record on the first transcription unit and play that without loss of continuity and so on.

You can also have both transcription units playing at the same time and switch backwards and forwards between to records by alternately depressing the Phono 1 button and the Phono 2 button.

Input sensitivity

When switching from one program source to another the output should not change. To obtain this you will need to set the input sensitivity controls as follows:

Depress the FM button and tune in a strong FM station. Then switch over to a program from Phono 1 by depressing the Phono 1 button, and adjust the Phono 1 sensitivity control (marked Input Level at the back of the receiver) to obtain the same output as for the FM program. The adjustment range for the Phono 1 input is 2.2 to 10 mV.

The sensitivity of the Phono 2 input is fixed at 3 mV and cannot be adjusted.

Adjust the Tape 1 and Tape 2 sensitivity controls (marked Input Level at the back of the receiver) in the same manner, one after the other, while you listen to programs from the respective tape recorders. The adjustment range of the Tape inputs is 150 to 600 mV.

NOTE! Depressing either of the Phono buttons automatically disconnects any radio program that is present (but not a tape program because tape programs have preference).

One tape recorder

To play tapes from one tape recorder, connect the tape recorder to the Tape 1 socket (using either phono or DIN plugs), start the tape recorder and depress the Tape 1 Monitor button on the front panel.

Two tape recorders

To play tapes from two tape recorders (one at a time), connect the two tape recorders to the Tape 1 and Tape 2 sockets. To play a tape from the Tape 1 machine, depress the Tape 1 Monitor button and start the tape recorder.

To play a tape from the Tape 2 machine, release the Tape 1 button and depress the Tape 2 button and start the tape recorder.

Input sensitivity

The sensitivity of Tape 1 input and Tape 2 input can be adjusted to be between 150 and 600 mV by

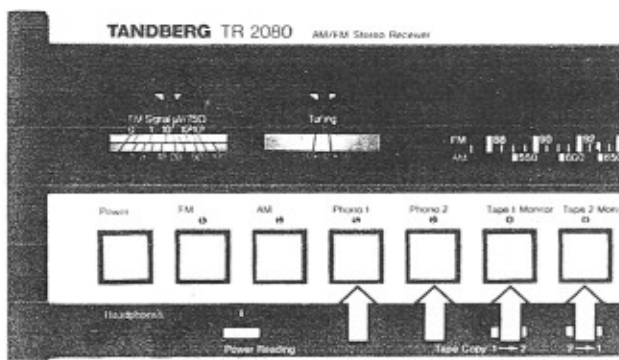

means of independent potentiometers adjacent to the sockets. See last page.

NOTE! Depressing either of the Tape Monitor buttons automatically disconnects any record or radio program that is present. Furthermore, Tape 1 Monitor always take precedence over Tape 2 Monitor when both these buttons are depressed simultaneously.

Recording from the receiver

Connect one or two tape recorders to Tape 1 input and/or Tape 2 input (or both) at the back of the receiver. Use phono or DIN plugs. Depress either the FM or the AM button and tune the receivers as described on page 6 or page 9. Any radio program that is being reproduced in the speakers (or headphones) will now be fed via the sockets marked Out to the tape recorder and recorded. The Volume, Balance, Bass, Midrange, Treble, Loudness, and Filter controls will have no effect on the recording. The recorded program will be fed to the receiver via the sockets marked In where it will be

available for a tape test if required (see Monitoring during recording on page 16).

Recording via Tape 2 with tone corrections, see page 18.

Recording from a transcription unit

Connect a transcription unit (or record player) to the Phono 1 socket and a tape recorder to the Tape 1 socket at the back of the receiver. Put the tape recorder into the RECORD mode but do not start it. Start the transcription unit and depress the Phono 1 button. Let the record run for a minute or two and note the indication on the tape recorder input level meter. Adjust the input level controls on the tape recorder to take account of any peaks in the output from the record. Stop the transcription unit.

Now you can start the proper recording. Start the transcription unit and the tape recorder. The recording will be unaffected by all the other audio controls. See page 16 for advice on monitoring.

Two transcription units

A second transcription unit can be connected to the Phono 2 socket so that when the record on the first transcription unit comes to an end a second record can be recorded without stopping the tape recorder, provided that you know there are no output peaks on the second record greater than those on the first record.

As the first record ends, start the second transcription unit and depress Phono 2 button.

Two tape recorders

An extra tape recorder can be connected to the Tape 2 socket. You can now record on both tape recorders simultaneously. (You can tone correct the program connected to the Tape 2 input, see page 18.)

Copying tape

Two tape recorders are involved when copying from Tape 1 to Tape 2 or vice versa.

Connect one tape recorder to the Tape 1 socket and another tape recorder to the Tape 2 socket.

To copy from the Tape 1 machine to the Tape 2 machine depress the Tape Copy 1→2 button.

To copy from the Tape 2 machine to the Tape 1 machine depress the Tape Copy 2→1 button.

Start the two machines and control the recording level on the machine set to RECORD. A trial run may be necessary to avoid peak distortion. See page 16 for advice on monitoring.

NOTE! You have the great advantage that copying from one tape recorder to the other can take place while you listen to a program selected with any of the buttons FM, AM, Phono 1, and Phono 2.

You can tone-correct the program connected to the Tape 2 socket if you wish. To do this, press the Preamp Rec Tape 2 and Tape 1 Monitor buttons in, and release the Tape Copy 1→2 button. You cannot listen to another program at the same time (see page 18).



Program testing (monitoring) during recording

Some tape recorders – including Tandberg machines – have facilities for monitoring programs during recording (tape-test). The test consists of listening to the tape on the speakers or headphones while the recording continues. The object is to ensure that the recording is free from noise and distortion.

Program testing (monitoring) for one tape recorder connected to Tape 1

1. Start the recording and set the tape recorder into the tape-test mode. On the latest Tandberg machines you should press in the SOURCE/TAPE button to put the tape recorder into the tape-test mode. See also the operating instructions for your particular machine.
2. At first let both Tape Monitor buttons on the radio be out. You will now hear the program as it is applied to the input of the tape recorder.
3. Press in the Tape 1 Monitor button. You will now hear the program after it has been applied to the tape recorder, recorded on tape, played back again and fed back to the radio receiver. Adjust the OUTPUT LEVEL controls so that the sound volume is exactly the same as when the Tape 1 Monitor button was out.

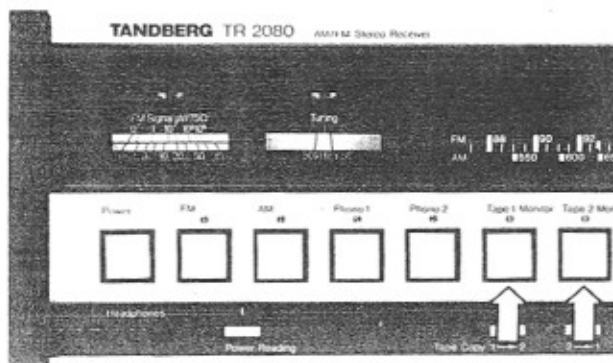

4. Press in and release the Tape 1 Monitor button several times in quick succession. If the recording is being properly made, you will hear no noticeable reduction in the sound quality when the button is pressed in.

Program testing (monitoring) for a tape recorder connected to Tape 2

The same as for Tape 1, but use Tape 2 Monitor button.

Program monitoring on Tape 2 during a tone-corrected recording can only be carried out on the tape recorder (see page 18).

Combined record/playback

A program from FM, AM, or a record player can be *recorded* on a tape recorder at the same time as a tape is *played back* from another tape recorder.

Recording via Tape 1, playback via Tape 2

Press in the button for the program to be recorded and start Tape 1 tape recorder in the record mode. Then press in Tape 2 Monitor button and start Tape 2 tape recorder in the playback mode. The program from this tape recorder will be reproduced over the speakers. To test (monitor) the recording on Tape 1 tape recorder, press in the Tape 1 Monitor button. You can also monitor on headphones plugged into the tape recorder.

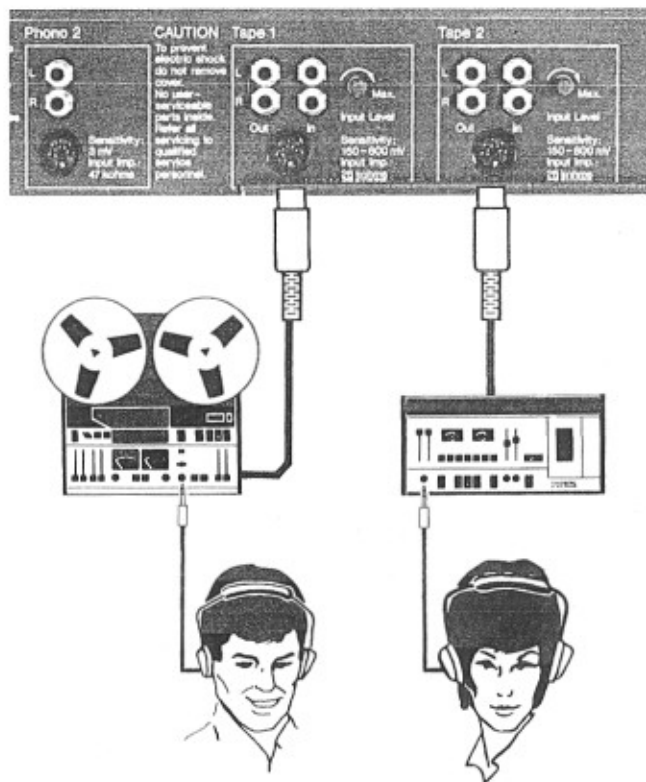

Recording via Tape 2, playback via Tape 1

Press in the button for the program to be recorded and start Tape 2 tape recorder in the record mode. Then press in Tape 1 Monitor button and start Tape 1 tape recorder in the playback mode. The program from this tape recorder will be reproduced over the speakers. To test (monitor) the recording on Tape 2 tape recorders, release Tape 1 Monitor button and press in Tape 2 Monitor button.

NOTE! You cannot make a tone-corrected recording on Tape 2 and playback from Tape 1 at the same time (see page 18).

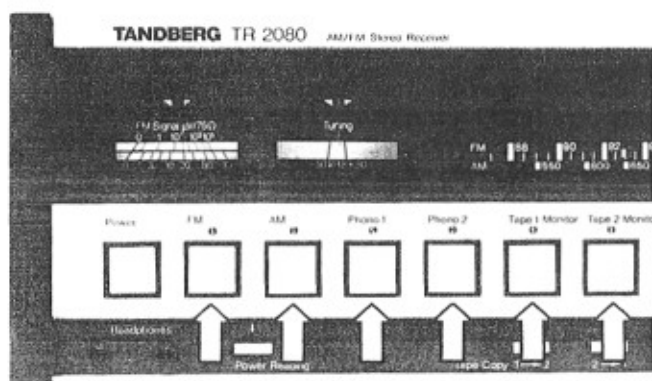

Use of Output Preamp. and Input Poweramp. sockets

The four sockets on the extreme left on the back panel give access to the pre-amplifier outputs and the power amplifier inputs.

The sockets are intended for connection of external network such as equalizers, echo boxes, and reverb units.

NOTE! For normal use the sockets must be strapped together with U links as shown in figure (a).

When an external network is required between the Preamp and the Poweramp, remove the U links and connect according to figure (b).

Technical data: See back cover.

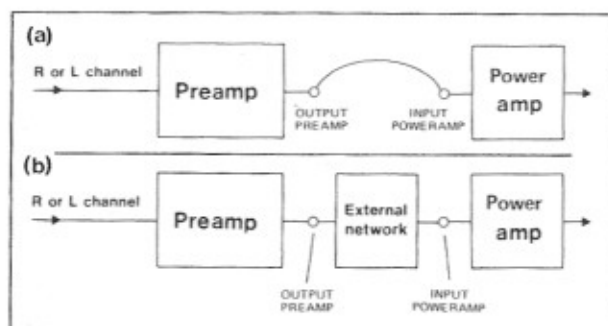
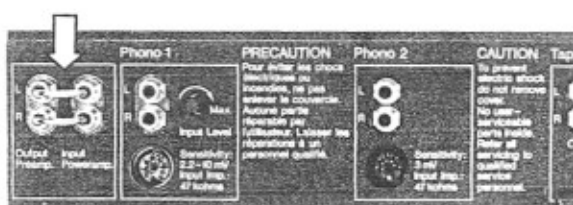

Recording a tone-corrected program via Tape 2 socket

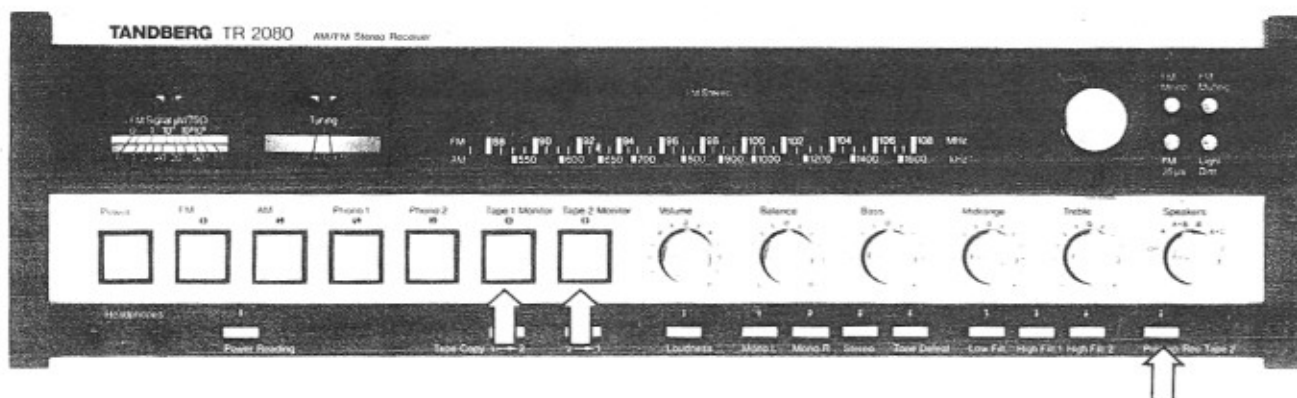

WARNING! Depressing the Preamp Rec Tape 2 button reduces the amplification by 20 dB. Therefore be careful not to release the button when playing at high volume. *Otherwise you may damage your speakers.*

Press in the Preamp Rec Tape 2 button (lower right). You can now control the program to the tape recorder with the volume and tone controls, Loudness and Filter buttons. This enables you to obtain special effects.

NOTE! The tone controls will only function when the Tone Defeat button is out (see page 9).

When the Preamp Rec Tape 2 button is out, recording takes place in the normal manner and the program is not affected by the volume and tone controls.

If you want to test (monitor) the program being recorded, connect headphones direct to the tape recorder (see page 16).

NOTE! Tape 2 Monitor button must not be pressed in when you are making a tone-corrected recording. If it is, the recording will be destroyed. Tape 1 Monitor button must only be pressed in when the program you are tone-correcting comes from Tape 1.

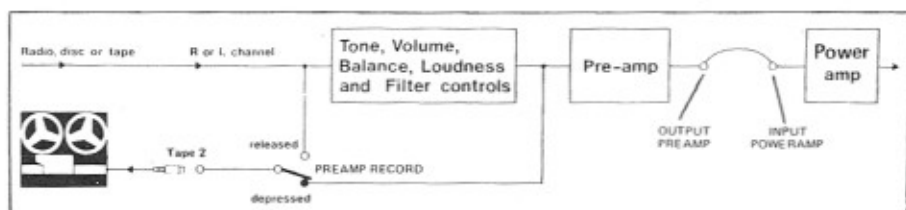

4 Channel use

The Tape 1 and Tape 2 sockets are also suitable for 4 channel use.

To play a 4 channel program a 4 channel decoder must be connected with its input to the Tape Out sockets. The front output signal from the decoder must be fed back to the Tape In socket of the receiver and the rear output signal to an auxiliary rear channel amplifier.

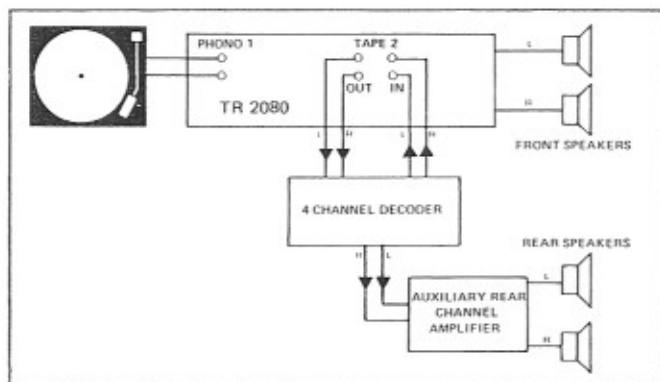

Plugs

The plugs must be wired as shown below.

The plugs are seen from this side. 

Tape recorder (TAPE 1 and TAPE 2) DIN plug

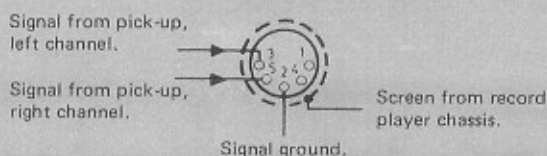

The signal ground and screen must not be wired together.

Contact 1 and 5 are joined together on the socket.

Record player (PHONO) DIN plug

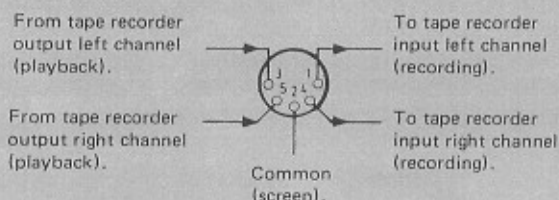

Headphones (PHONES) jack plug

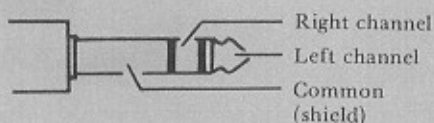

Useful data

Inputs

	Input sensitivity for nominal output in 8 ohms at 1 kHz	Input impedance	Maximum input signals (0.2% distortion at 1 kHz)	
			Max. sensitivity	Min. sensitivity
PHONO 1:	Adjustable 2.2 to 10 mV	47 kohms	120 mV	420 mV
PHONO 2:	3.0 mV	47 kohms	150 mV	
TAPE 1:	Adjustable 150 to 600 mV	25-30 kohms	7.5 V	28 V
TAPE 2:	Adjustable 150 to 600 mV	25-30 kohms	7.5 V	28 V
Main amplifier input:	440 mV	10 kohms		

Outputs

	Output voltage	Output impedance
PREAMP:	5 V at 0.1% distortion	1 kohm 20 - 20,000 Hz
TAPE 1 and 2 (DIN sockets):	125 mV at 100% FM modulation* 250 mV at 100% FM modulation**	33 kohms
TAPE 1 and 2 (phono sockets):	500 mV at 100% FM modulation* 1 V at 100% FM modulation**	1 kohm

* US model

** Standard model

Output power in speakers: See curve page 12 and table page 13.

Output power in headphones: See curve page 13.

TANDBERGS RADIOFABRIKK A/S
P.O.Box 9, Korsvoll
N - OSLO 8 - Norway