

OWNER'S MANUAL

# X-10R/X-7R

Stereo Tape Deck

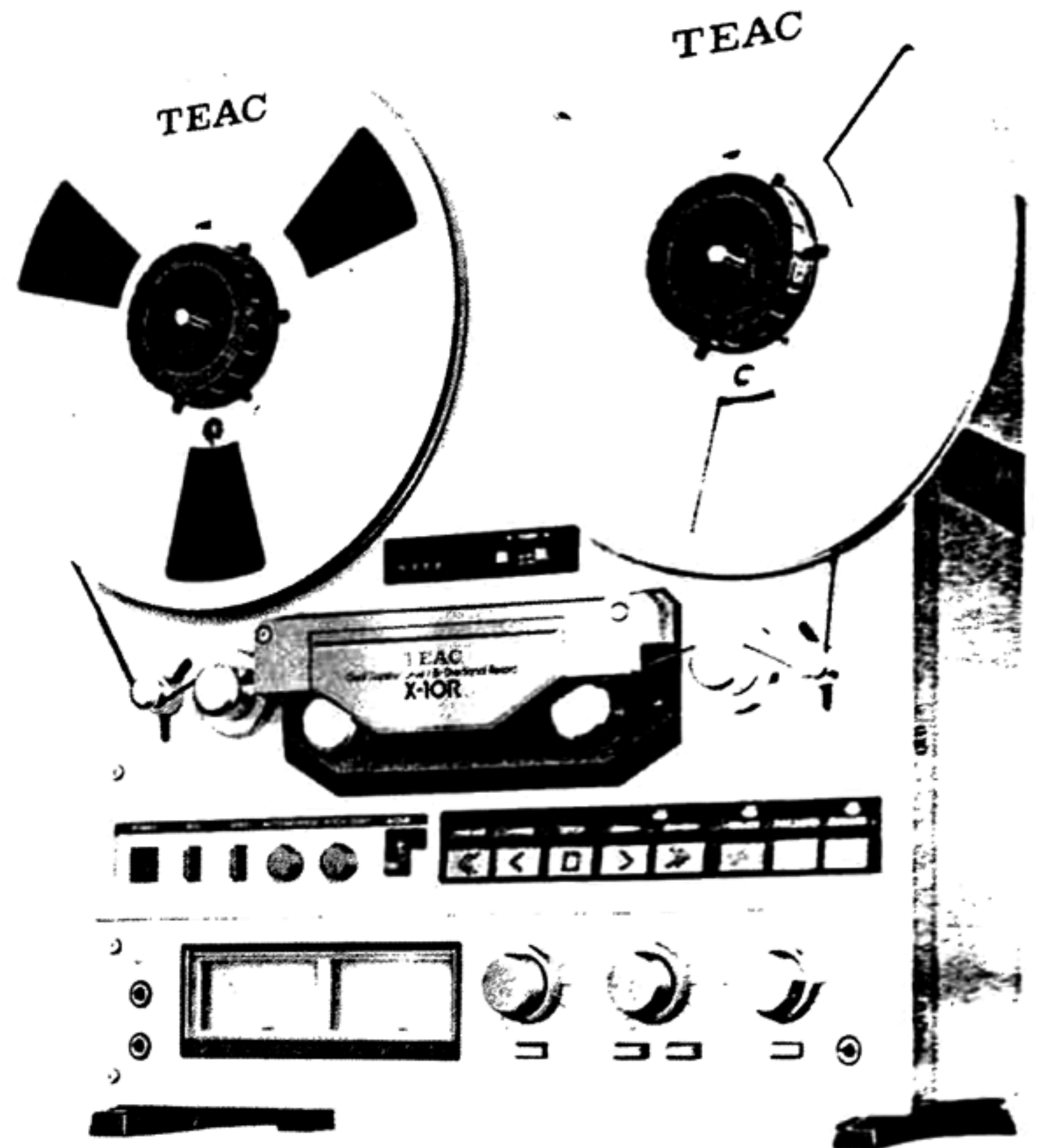

# Introduction

Thank you for buying TEAC.

From the bewildering choice of tape decks available, you finally decided upon a TEAC. You have made a very wise choice because it was designed and built to the very highest standards. Be sure to get maximum value from it by reading this manual carefully, especially before you use it for the first time.

## WARNING:

**TO PREVENT FIRE OR SHOCK HAZARD, DO NOT EXPOSE THIS APPLIANCE TO RAIN OR MOISTURE.**

This tape deck has a Serial Number located on the rear panel. Please record the Model Number and Serial Number and retain them for your records.

Model Number \_\_\_\_\_  
Serial Number \_\_\_\_\_

## How to use this Manual

This manual has been written for the X-10R and the X-7R open reel tape decks. They are similar in most respects, the most obvious difference being that the X-10R can take the larger 10-1/2 inch reels.

Throughout this manual, the two machines are described side by side and the explanations may be taken as applying to both models except where indicated.

This manual is divided into five distinct parts. These are:

1. The Indexed Illustrations  
Illustrations of the front panel fold out for easy reference as you use the manual. On the next pages are views of the back panels with recommended interconnections.
2. Step-by-step Record and Playback Instructions  
These instructions make the assumption that you have no idea how to operate your new deck but would like to get some instant results. The instructions are therefore very explicit but do not tell you the whys and wherefores of what you are doing. For that you are referred to...
3. The Controls  
Every knob, switch, meter, socket and any other feature located anywhere on the outside of the deck has its function and use explained. The numbers used are the same as those on the fold-out illustration. When you know what everything does, you may wish to find out something about the deck's...
4. Special Features and Techniques  
TEAC's X series decks incorporate some very sophisticated developments. For those with an enquiring mind, this section explains some of the things that makes your new deck the superlative machine it is and how to use it to get the best out of it.
5. Specifications

## Table of Contents

|  |          |
|--|----------|
| Introduction .....   | 1        |
| How to use this Manual .....   | 1        |
| Reference Illustrations and Rear Connections .....   | 2, 3, 4  |
| How to make a Recording and Playback .....   | 1, 5     |
| Controls .....   | 5, 6, 7  |
| Special Features .....   | 8, 9, 10 |
| Dual Capstan Closed-loop System, Magnefloat Bearings,<br>Electrical Braking (X-10R), Real-time Pause (X-10R),<br>Rack Mounting, dbx System Compatible (X-10R),<br>Sensing Foil, Two-way Cue Monitoring (X-10R),<br>Erasing, Six Heads, Four Track Heads, Clamping the Reels,<br>Using the Meters to set the Recording Level,<br>Over Dubbing (Punch in Recording), Dubbing |          |
| BIAS and EQ Setting Chart .....  | 10       |
| TIMER Recording and Playback Connections .....   | 10       |
| Maintenance .....  | 11       |
| Specifications .....   | 11       |
| Optional Accessories .....   | 12       |

## How to make a Recording

This section tells you, step-by-step, exactly how to record a tape. The experienced recordist may choose to skip this section or just glance through it quickly. Check each  with a pencil to be sure that you haven't missed anything.

1. You need a reel of tape and an empty reel. Use the same type of reel on both sides; i.e., don't mix 7 inch plastic and large 10-1/2 inch metal types. If you use the large metal type, you will need to fit the special hub adaptors onto the reel tables. The tape spools must be clamped on tightly. Details on how to do this are given on page 9.

**Note:** The X-7R cannot take 10-1/2 inch reels and therefore hub adaptors are not supplied.

Mount the full spool on the left reel table with the loose end of the tape on the left side of the reel.

Mount the empty reel on the right reel table.

Thread the tape over the rollers and through the heads exactly as shown in the illustration.

Turn the right reel a few times counterclockwise by hand to make sure the tape is being drawn through the machine.

2. Before plugging in the line cord or making any connections, make sure that all the controls are set as follows:

TIMER ③ Both out   
Counter button ② Press for 0000

|                |   |                          |
|----------------|---|--------------------------|
| POWER ⑳        | OFF   | <input type="checkbox"/> |
| REEL Switch ㉑  | LARGE for 10-1 2<br>reels<br>SMALL for 7<br>reels | <input type="checkbox"/> |
| SPEED ⑲        | HIGH  | <input type="checkbox"/> |
| AUTO REVERSE ④ | —   | <input type="checkbox"/> |
| PITCH CONT ㉒   | Pushed in (OFF)                                   | <input type="checkbox"/> |
| REC MODE ⑮     | ON (▢)  | <input type="checkbox"/> |
| REC BIAS ⑭     | 2 (▢)*  | <input type="checkbox"/> |
| REC EQ ⑬       | 2 (▢)*  | <input type="checkbox"/> |

\*These settings may not be optimum as they depend on the type of tape you are using. See page 10 for further details when you are more familiar with the basic recording technique. At this stage the setting doesn't matter but for the best quality recording and playback it is important and should not be neglected.

|           |            |                          |
|-----------|------------|--------------------------|
| MONITOR ⑫ | SOURCE (=) | <input type="checkbox"/> |
| MIC ①     | MIN (·)    | <input type="checkbox"/> |
| LINE ⑩    | MIN (·)    | <input type="checkbox"/> |
| OUTPUT ⑨  | MIN (·)    | <input type="checkbox"/> |

3. That completes the initial setting of all the controls. The deck is now "safe" for you to connect to your amplifier or receiver and to plug into the AC line outlet. However, before you do so, turn to the rear panel of the deck and check the following: Locate the dbx unit terminals ㉓ and see that the special shorting links are firmly in place.

Continued on page 5.

# Reference Illustrations

X-10R

Tape Path

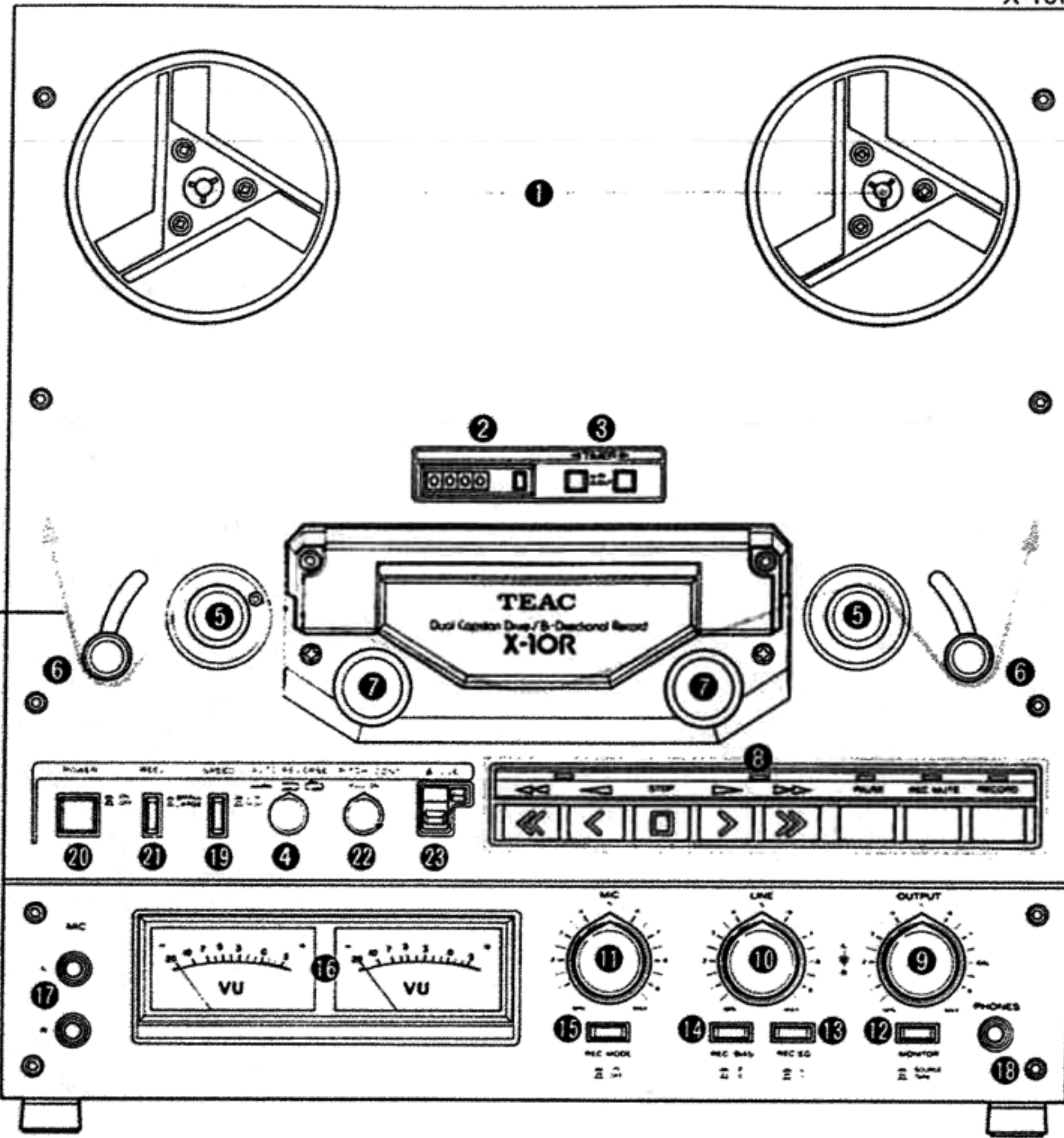

X-7R

Tape Path

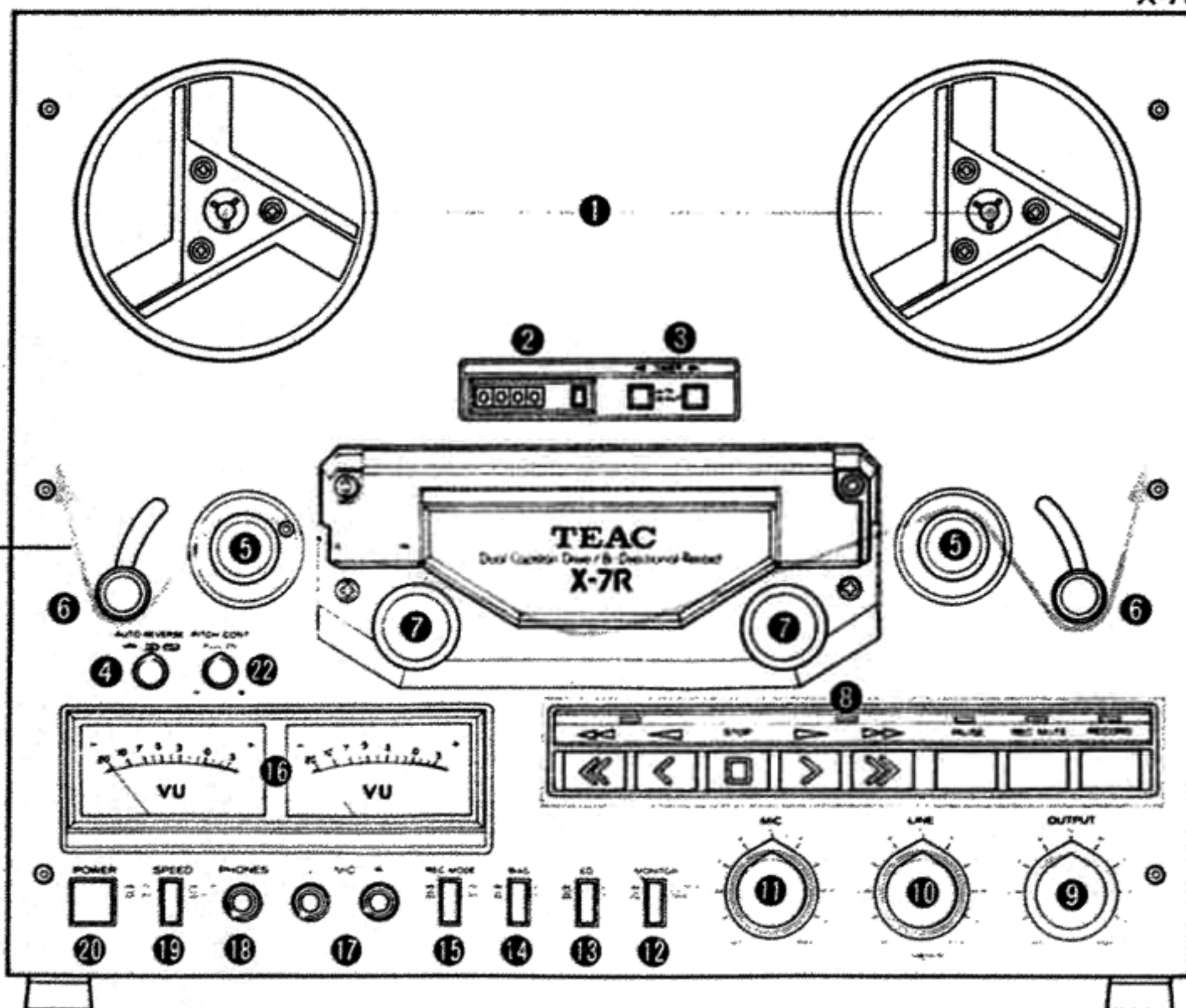

# Rear Connections : X-10R

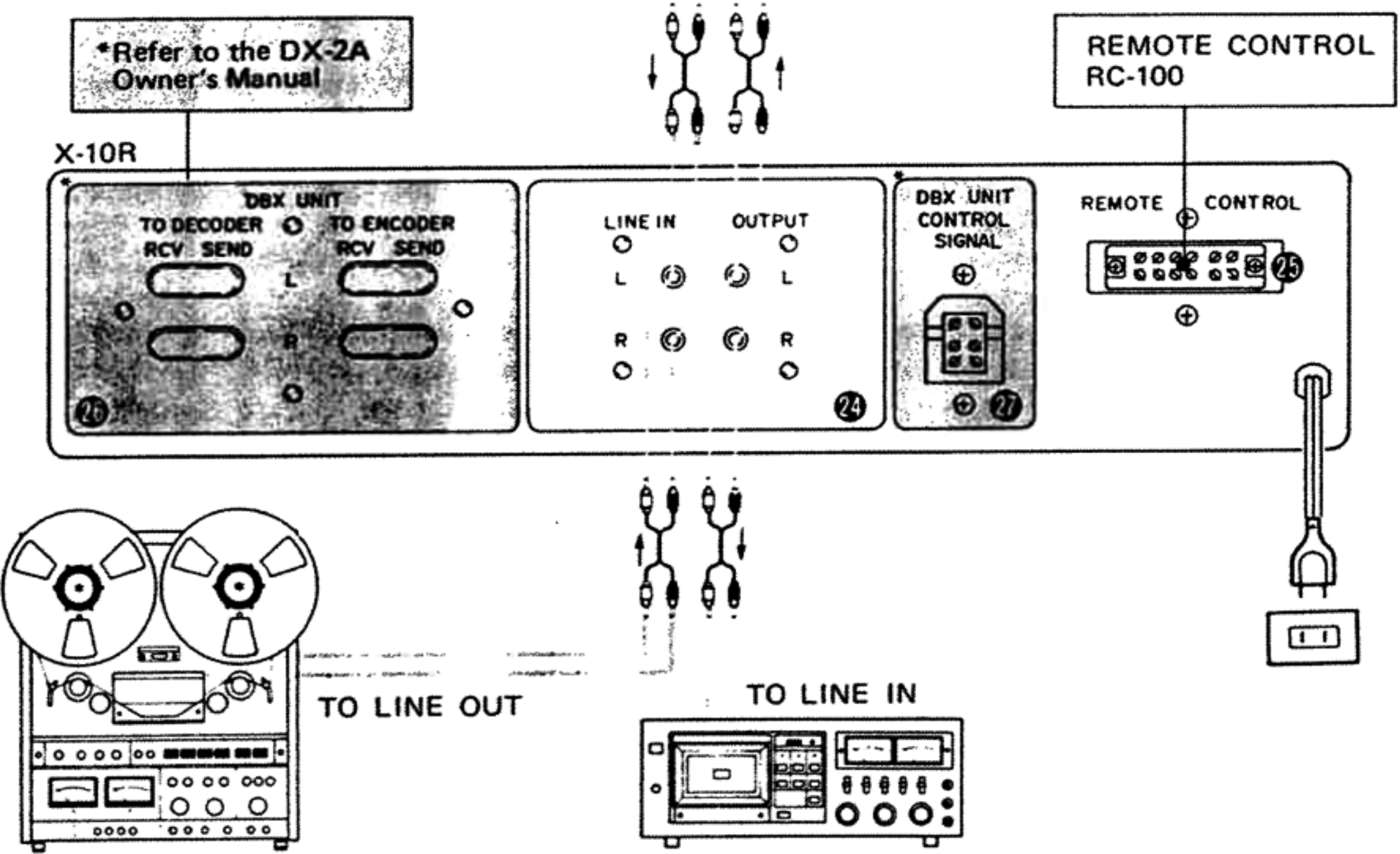
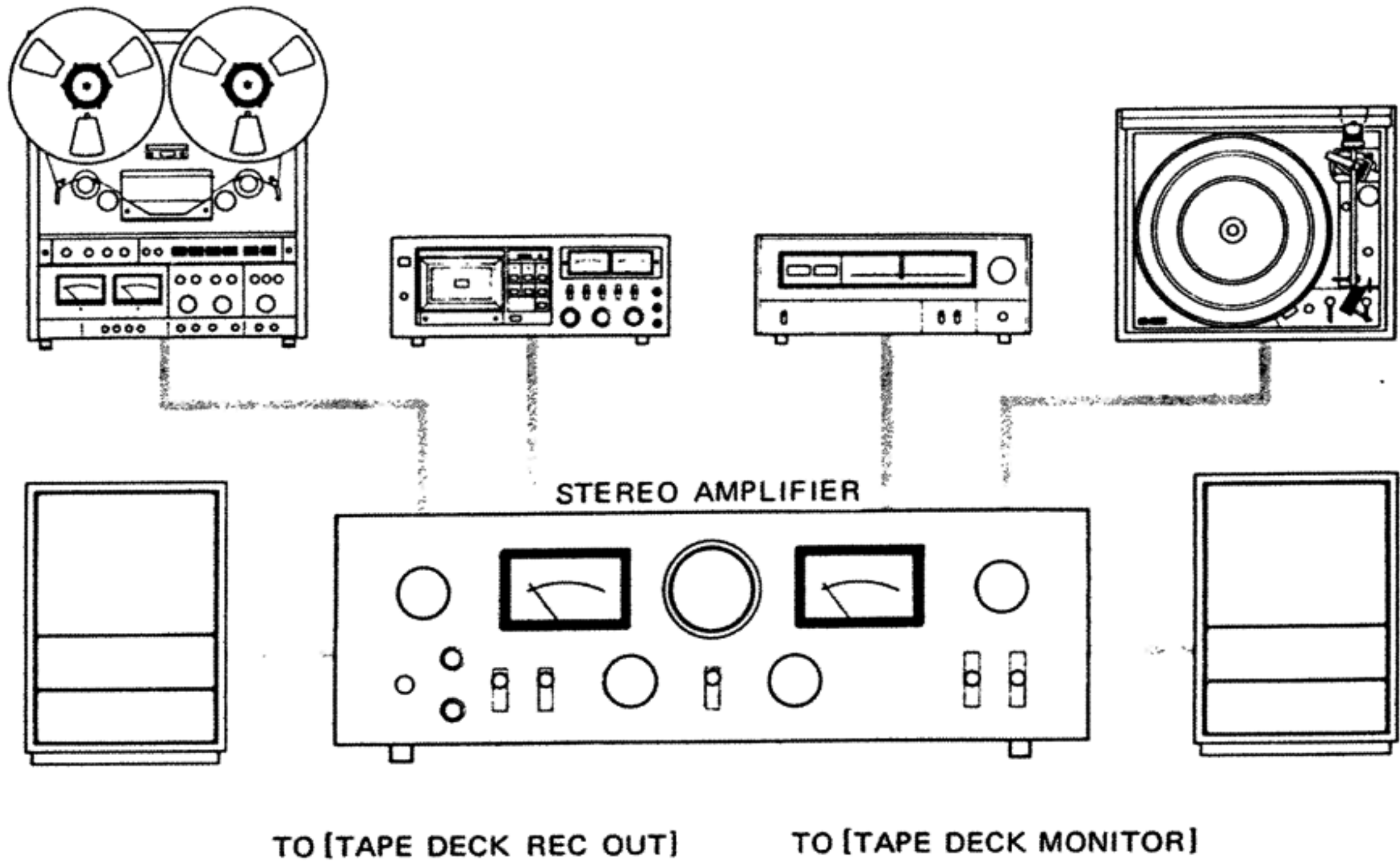

## Microphones and Headphones Connections

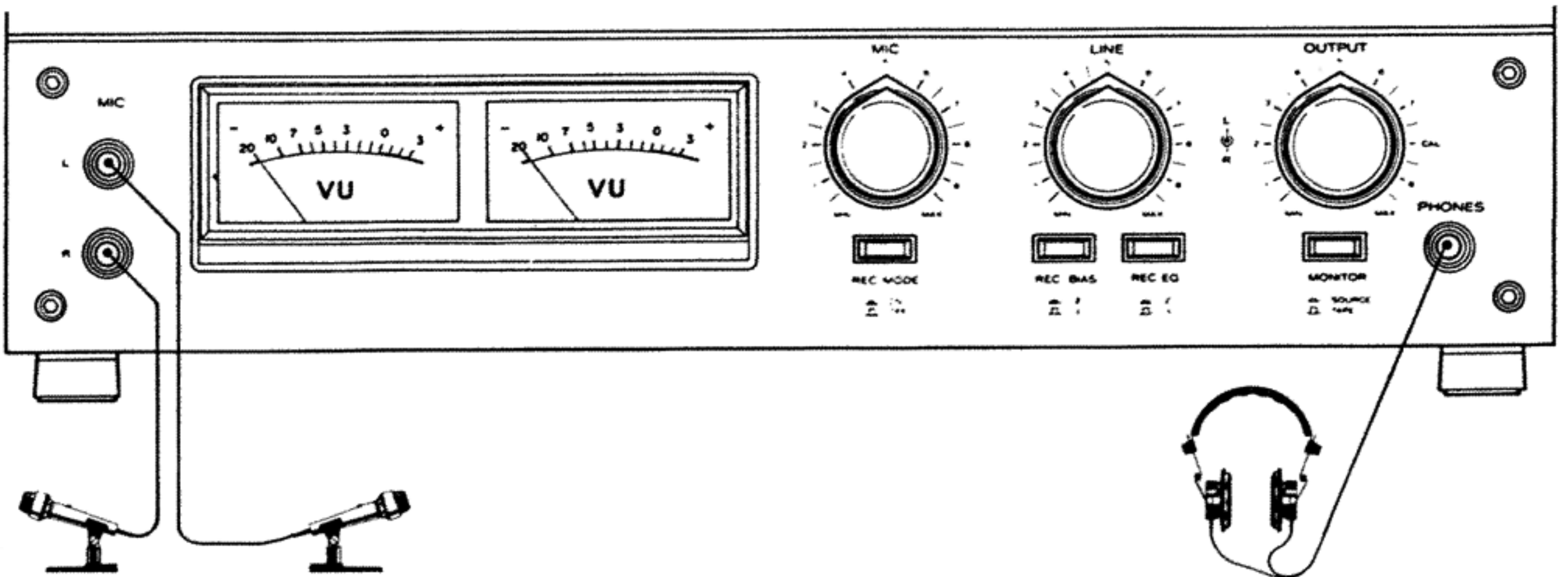

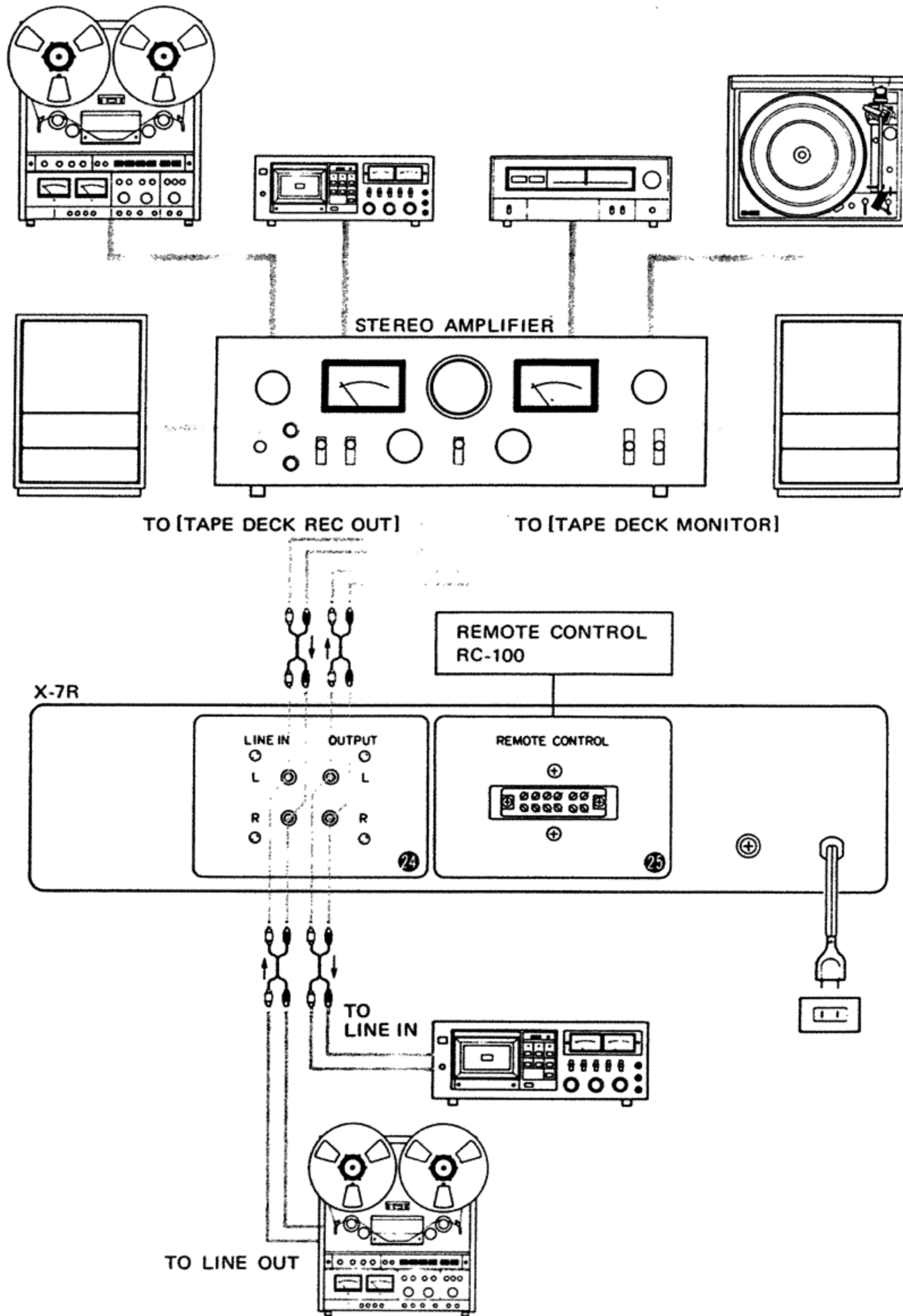

## Connections

- Please be sure that you have read thoroughly the instructions for the amplifier you intend to use with the models X-10R/X-7R. Turn off power on both units before making connections.
- Connect the line out of the amplifier to the LINE IN terminals on the rear panel of the deck. Connect the OUTPUT terminals on the deck to the tape input on the amplifier.

## Connections to Another Deck

- Other tape decks may be connected directly to this deck for dubbing (copying) of tapes. See page 10.
- Some stereo amplifiers have terminals for connecting two or more tape decks and special switching functions for tape dubbing. Carefully read the Instruction Manual for your stereo amplifier to learn the correct operation of these facilities.

## Power Connections

- Many stereo amplifiers have power outlets for connections to other equipment that are controlled by the stereo amplifier power switch. Use of this provision may simplify power connections.

Continued from page 1.

Locate the serial number near the line cord. It shows the AC line voltage requirements of the deck; for example, 117 V AC 60 Hz. Does it match the power available in your locality? If it does, it is safe to plug the line cord into an AC outlet. If you are in any doubt on this point, please consult your dealer. OK

Using the pin cords supplied, connect the OUTPUT terminals ② on the rear panel of the deck to the "Tape In" or "Tape Monitor" terminals on your amplifier or receiver. OK

Set the amplifier or receiver for tape monitor or play. Consult the owner's manual if you're not sure how to do this. As we don't know what amplifier you will be using, we cannot give specific instructions on this point. OK

Using the pin cord supplied, connect the "Line Out", "Aux. Out" or "Tape Out" terminals on your amplifier to the LINE IN terminals ③ on the deck. OK

**Note:** Be sure to connect L(ef) terminals on the deck to left terminals on the amplifier and R(ight) terminals to right. They are color coded white for left and red for right.

Select a suitable "program" on your amplifier for the tape deck to record. Either a radio program or a record will do fine. OK

**Note:** If you have an amplifier but no tuner or record player, you may use microphones instead, plugged into the MIC jacks ⑦. In this case you will have to use the MIC control instead of the LINE control as described later. Microphone recording is more difficult, however, and is not recommended if this is your very first try.

4. Almost everything is now ready to start recording. If you have headphones, plug them into the PHONES jack ⑧ and use them to monitor the signal. If you don't, be sure your amplifier is in the tape monitoring mode otherwise you will merely hear the program (source) direct and could not be sure the deck was working.

Press the POWER switch. The VU Meters ⑥ and a red and a green LED (Light Emitting Diode) should light up. The red LED should flash and indicates that the deck is in the record stand-by mode. That means it is ready to record but is not actually doing so.

Gradually turn up the LINE control until the needles on the VU Meters indicate approximately 0. OK

For more specific advice on how to use the VU Meters, see page 9.

Turn up the OUTPUT control until a comfortable listening level over the headphones or amplifier/speaker system is achieved or set to the CAL position. OK

Simultaneously press both the forward play key (▶) and the RECORD key. OK

When you do that, the reels should start to turn, the tape counter to count and the red LED should stop flashing and stay on to indicate that the deck is in the record mode. If you now press and release the MONITOR switch to the TAPE (□) position you should hear the same program, perhaps very slightly degraded in quality if any of the settings were not quite right. What you are hearing now is the recorded sound, monitored off-the-tape. After you have recorded enough of the program to satisfy your curiosity. . .

Press the fast rewind (◀◀) key to fast-wind the tape back to the beginning again. OK

You have now made a recording and are ready to replay it. The process is almost identical to recording except for a couple of small points.

#### How to play a recorded tape

Follow the explanation just as given for recording except:

The LINE control does not need to be turned up and may be left at MIN (○). OK

The REC MODE switch should be released to the OFF (□) position. OK

The MONITOR switch must be set in the TAPE (□) position or you will not be able to hear what's recorded on the tape. OK

## Controls

In this section the controls are described and how to use them is explained. We are using the word "control" rather loosely to include all the switches, knobs, meters and everything else located on the deck. In some cases, very little explanation is called for as the use is obvious — like the POWER switch ② for example. In other cases there may be a lot more to it than "meets the eye" and here we give supplementary information. Take time to read all of this as correct understanding of some of the more complex parts will help you achieve the recording quality your deck is capable of.

### ① Reel Tables

These support either 7 inch reels or hub adaptors when 10-1/2 inch reels are used. See page 9 for details of the "QUIK-LOK" reel clampers and reel adaptors. Always check that adaptors and clampers are tightened securely before using the deck.

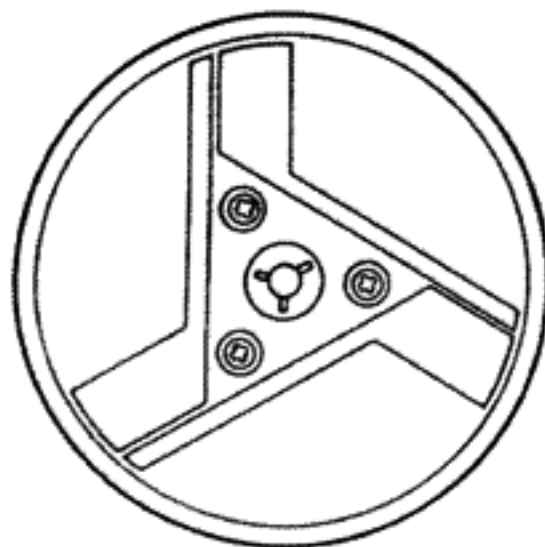

### ② Tape Counter ③ TIMER Switches

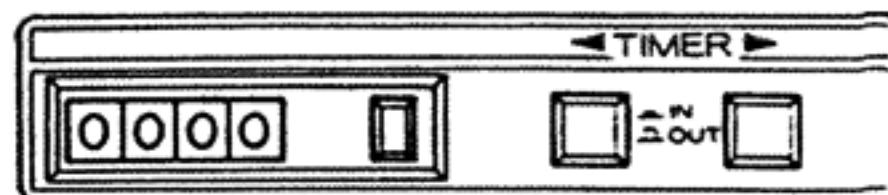

### ④ AUTO REVERSE Control

The use of these three controls is so closely linked that they are dealt with together. The Tape Counter can be reset to 0000 at any point on the tape by simply pressing the small button located to the right of the counter. Normally this button will be used to reset the counter at the beginning of a tape before playing or recording.

The TIMER switches enable the deck to be used with a clock controlled power source. They enable the deck to be set to record or playback under timer control. If either or both of the TIMER switches is IN (≡) the setting of the AUTO REVERSE has no effect, neither does the Tape Counter as it counts down past 0000.

The AUTO REVERSE control controls auto-reverse recording and playback as long as neither of the TIMER buttons is IN.

TIMER controlled recording or playback is easy to do but you will also need a clock controlled power outlet into which you plug the deck, amplifier and tuner (assuming you intend to record from the radio). See page 10 for connection details. All of these devices must be switched "on" in readiness and must be appropriately set. For TIMER controlled recording the REC MODE switch ⑤ on the deck must be set ON (≡). If the right (▶) TIMER switch is set IN (≡) and the left (◀) TIMER switch is set OUT (□), the deck will automatically go into forward record when power is applied. When the tape reaches the end, the deck will stop. Even if there is a metal sensing foil at the end of the tape, the deck will not go into reverse. If the left (◀) TIMER switch is set IN (≡) and the right (▶) TIMER switch is set OUT (□), the deck will automatically go into reverse recording when power is applied. Even if the tape counter counts down past 0000, the deck will not go into forward record. It will continue running in reverse record until the beginning of the tape is reached. The deck will then stop. If both TIMER switches are IN, when power is applied by the time switch, the deck will go into forward record. If there is a metal sensing foil at the end of the tape, when the tape reaches the end, the right (▶) TIMER switch will pop out and the deck will go automatically into reverse record until the beginning of the tape is reached. The deck will then stop. TIMER controlled playback is identical except that the REC MODE switch must be set OFF (□).

If both TIMER switches are OUT (□) the AUTO REVERSE facility can be used. When the switch is rotated to the left position (→) the deck may be set in either record or play mode in either forward or reverse direction. However, when the tape reaches the end, the deck will simply stop. In the center (≡) position, if the deck is set in forward record or play, on reaching the end of the tape (provided it is equipped with a metal sensing foil) the deck will automatically go into reverse record or play. When the AUTO REVERSE switch is set to the right (↶) position, what happens depends on whether the REC MODE switch is IN or OUT. If it is OUT, the following sequence takes place. On reaching the sensing foil at the end of the tape, the deck goes into reverse play. When the tape counter counts past 0000 the deck goes into forward play once again. This cycle repeats ad infinitum — great for background music and parties.

If the AUTO REVERSE switch is set to (↶) and the deck is put into the record mode, on reaching the end of the tape, the deck will go into the reverse record mode. However, it will ignore the tape counter and when the tape reaches the beginning, the deck will stop.

All this may seem a little complicated in the abstract. Spend an hour or two playing with all the possible combinations of these controls and you will soon get the hang of it. One cardinal rule that should be strictly observed is always to leave the TIMER switches OUT when timer control is not required.

### 5 Inertia Rollers and Sensing Post\*

Inertia Rollers turn with the tape and help to stabilize tape bounce for smooth tape running.

A Sensing Post is mounted on the left inertia roller. Auto-reverse facility is activated when sensing foil makes contact between the left Inertia Roller and the Sensing Post. See page 8 for Sensing Foil.

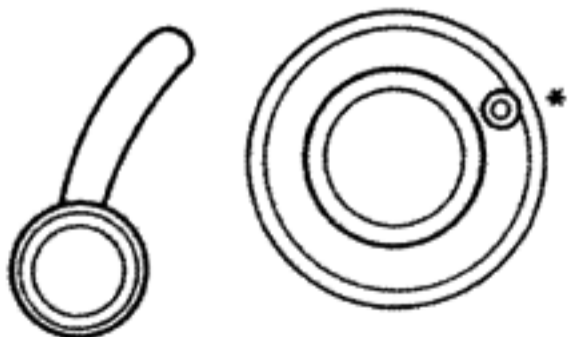

### 6 Tension Arms

These take up tape slack, stabilize tape movement and stop the deck if the tape

breaks or runs out. They contribute greatly to preserving and protecting your tapes.

### 7 Pinch Rollers

In the play and record modes, these pinch the tape to the capstans to drive the tape at the correct speed past the heads. They retract from the capstans very slightly when the PAUSE key is pressed, allowing the tape to stay in head contact. When the STOP key is pressed or the deck is put into fast wind, or the power is cut, the pinch rollers retract fully and the tape is lifted clear of the heads.

Note: The X-7R does not feature two-stage pinch roller retraction and the tape is lifted clear of the heads in all modes except play and record.

### 8 Tape Transport Control Panel

These soft-touch controls operate with feather-light pressure. Micro-switches inform the deck's logic circuits which keys have been pressed and the logic makes solenoids and relays do all the hard work. Starting from the right, the controls are:

RECORD: Pressing this key by itself has no effect. This is a safety feature to help prevent accidental recording. Provided the REC MODE switch is ON (≡) the RECORD key will put the deck into forward record if pressed simultaneously with the ► key. To put the deck into reverse record, press the RECORD key and ◀ key together. Pressing the RECORD key and PAUSE key together puts the deck into the record stand-by mode. The record stand-by mode means that the deck is all set and ready to record as soon as the play key ► or ◀ is pressed. It is useful for setting recording levels using the MIC or LINE controls and the VU meters. Remember to have the MONITOR switch in the SOURCE (≡) position. As the tape isn't moving yet, it's not possible to monitor off it.

The red LED above the RECORD key flashes to show that the REC MODE switch is ON and stays on continuously when the deck is in the record mode.

REC MUTE: Pressing this key while recording will record a period of silence on the tape. Pressing the RECORD or PAUSE keys will release the mute mode to resume normal recording or enter the record-pause mode.

PAUSE: Pressing this key in either the record or play modes causes the pinch rollers to retract. Tape motion stops but the selected mode is not disabled. To continue recording or playing, simply press the ► or

◀ keys. A green LED lights to indicate the pause mode.

►►: This is the fast forward key. Pressing it in any deck mode will cause the tape to wind rapidly from the left reel to the right reel.

►: This is the forward play key. Pressing it in any deck mode will cause the deck to go into forward play. Pressing it together with the RECORD key will make the deck go into the record mode if the REC MODE switch is ON (≡). You can go directly from play into record (if the REC MODE switch is ON) by simultaneously pressing the ► (play) and RECORD keys.

STOP: This key stops the deck and disables the previously selected mode.

◀: This is the reverse play key. Details are exactly the same as for the ► key except for the direction of tape travel.

◀◀: This is the fast rewind key. Details are exactly the same as for the ►► key except for the direction of tape travel.

### 9 OUTPUT Control

This controls the output fed to the amplifier and to the headphone jack (PHONES). The signal will depend on the setting of the MONITOR switch. In the TAPE position the output comes from the tape (off-tape monitoring) and in the SOURCE position it comes directly from the input. The OUTPUT control is in fact a dual concentric type so that the left and right channels can be controlled separately.

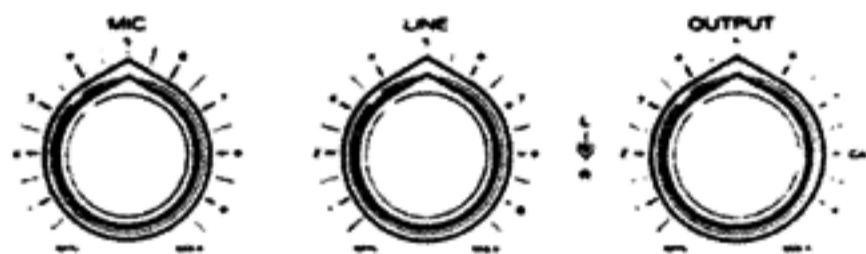

### 10 LINE Control

This knob adjusts the level of the line input signal before it is recorded on the tape. Always adjust it so that the signal gives the highest possible average reading on the VU meters in the black zone. Occasional peaks into the red area will not matter, but sustained peaks above 0 VU will cause distortion. See "VU Meters" for more information. As with the OUTPUT control, the left and right channels may be adjusted separately if required.

### 11 MIC Control

This works just like the LINE control, except that it controls the level from microphones plugged into the MIC jacks. Microphone signals may be combined with line signals by simply using both the MIC and LINE controls. This is known as MIC/LINE mixing.

### 12 MONITOR Switch

There are two positions, SOURCE and TAPE. The switch simply selects either the signal on the tape (TAPE) or the signal present at the LINE or MIC inputs (SOURCE). The selected signal is fed to the

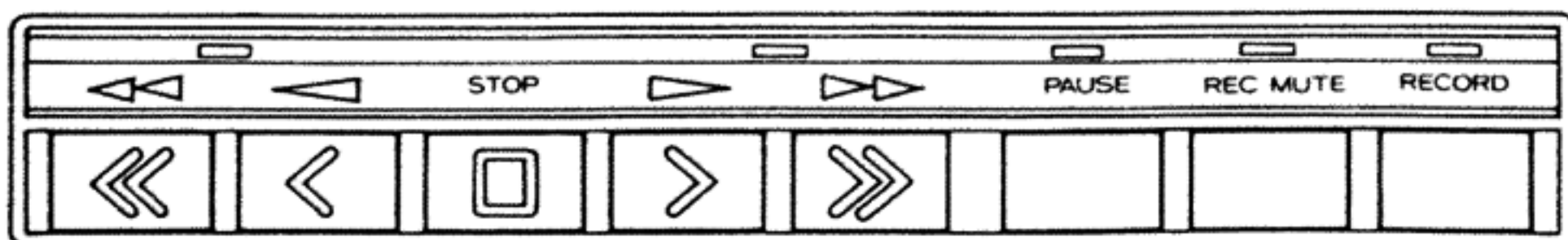

outputs (OUTPUT terminals and PHONES jack) via the OUTPUT control. When the monitor switch is in the SOURCE position, the display on the VU meters is not affected by the position of the OUTPUT control. However, when the MONITOR switch is in the TAPE position, the level displayed on the meters is controlled by the setting of the OUTPUT control. If the OUTPUT control is set to the CAL (calibration) position; there should be little or no difference in volume and sound quality apparent on switching between TAPE and SOURCE.

**13 REC EQ (EQ)**

**14 REC BIAS (BIAS)**

Different brands of tape require different degrees of bias and equalization (EQ) for optimum sound quality. The tapes listed on page 10 are recommended for use with your X-10R or X-7R, together with the appropriate switch settings for the EQ and BIAS switches. During playback these have no effect and may be left in any position.

**15 REC MODE**

This switch enables the recording circuitry. If it is in the OFF (□) position, recording is not possible. If it is left in this position when timer operation is used, the deck will go into the play mode.

Set to ON (▢), it enables the deck to make recordings if the appropriate keys are pressed (see "How to make a recording"). Under timer controlled operation the deck will go into the record mode. When recording is not specially required it is always best to leave this switch in the OFF position.

**16 VU Meters**

These meters measure the voltage of the audio signal being fed to the tape or to the output. When the MONITOR switch is in the SOURCE position the meters measure the signal level being fed to the tape. This level is controlled by the LINE or MIC controls. The setting of the OUTPUT control does not affect the meter reading. With the MONITOR switch in the TAPE position, the meters indicate the signal coming off the tape and being fed to the output. This signal is controlled by the OUTPUT control and so the meter display will be affected by the setting of the OUTPUT control. See page 9 for information on optimum record-level adjustment.

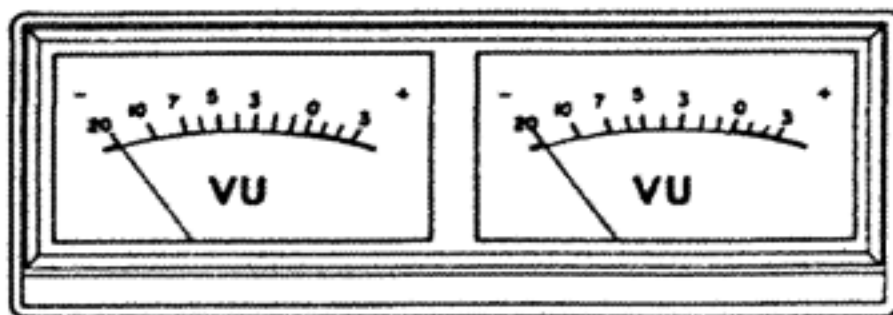

**17 MIC Jacks**

There are two jacks for use with 200 ohm microphones, though 150 – 10 kohm microphones may also be used. L is for the left channel and R is for the right. Good

microphone recording technique is a skill that takes some aquiring. Much experimentation and supplementary reading is recommended. Three initial tips, however:

Always record at the maximum possible level short of overloading the tape (see sections on LINE & MIC controls and VU Meters).

Record in "dead" rooms full of soft furnishings, not in "live" rooms with lots of hard, reflecting surfaces.

Monitor with headphones, never with loudspeakers.

**18 PHONES Jack**

Connect here for headphone monitoring or private listening. The sound level can be controlled using the OUTPUT control.

**19 SPEED Switch**

LOW (▢) selects a tape speed of 3-3/4 ips and HIGH (□) selects a tape speed of 7-1/2 ips. The high speed gives better quality recordings and is recommended for all important music recordings. The LOW speed is more economical as it uses less tape. It is recommended for less important recordings such as party/background music, speech etc.

**20 POWER Switch**

This controls AC power to the deck. Press for on, press again for off. Remember to leave it in the ON position for timer controlled operation.

**21 REEL Switch (X-10R only)**

When large diameter 10-1/2 inch reels are used, greater back tension is required for correct operation. 7 inch reels require less back tension. This switch sets the correct amount of back tension. Set it to suit the size of reel you are using.

**22 PITCH CONT**

When this control is pressed in, the speed of the tape deck is precisely controlled. Sometimes, however, recording or playback at slightly different pitches is required. Pulling the knob (PULL ON) and rotating it to left or right enables ±6% adjustment in tape speed to be made. Leave it pressed in when this facility is not required.

**23 CUE Lever (X-10R only)**

During fast wind or rewind pushing this lever enables the sound recorded on the tape to be monitored if the MONITOR switch is in the TAPE position. Pushing the lever just a little disables the muting on the replay amplifier and allows the tape to make contact with the heads. Pushing the lever fully up retracts the tape lifter and allows the tape to make contact fully with the replay heads for a stronger monitoring signal. Regardless of whether the tape is fast winding or fast rewinding, it is possible to monitor either tracks 1 & 3 (the "forward" tracks) or tracks 2 & 4 (the "reverse" tracks). The green LED located between ◀◀ and ◀ or ▶▶ and ▶ indicated if it is the forward or reverse tracks that are being monitored. Let us suppose that the tape is

fast rewinding and that the LED between ▶ and ▶▶ indicates that tracks 1 & 3 are being monitored. If you want to monitor the "reverse" tracks 2 & 4, hold down the ◀◀ key and while holding it down, briefly touch the ◀ key. The LED between ◀◀ and ◀ will now come on. Release the ◀ key. The deck will automatically have switched its monitoring circuits to tracks 2 & 4.

**REAR PANEL**

**24 LINE IN & OUTPUT Terminals**

Line level signals to the deck are connected to the LINE IN terminals. Low level signals from a microphone must go to the MIC inputs on the front panel. Low level signals direct from a phono cartridge cannot be used directly and must be fed to a Hi-Fi amplifier first. The OUTPUT terminals are used for connecting the output of the deck to your amplifier.

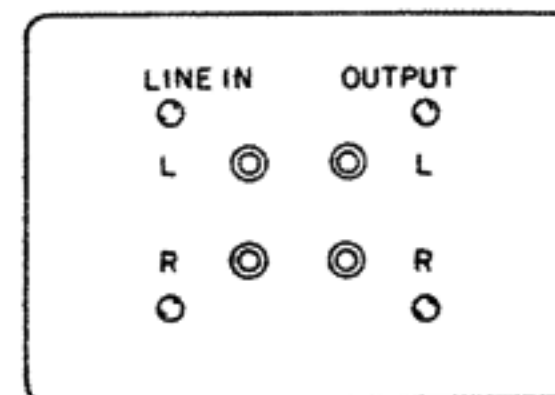

**25 REMOTE CONTROL**

Connect the optional RC-100 to this socket for remote control of your deck from up to 15 feet away.

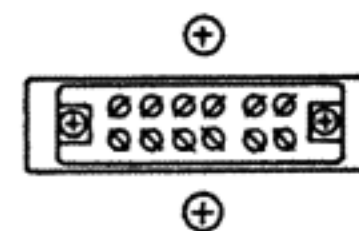

**26 DBX UNIT Terminals (X-10R only)**

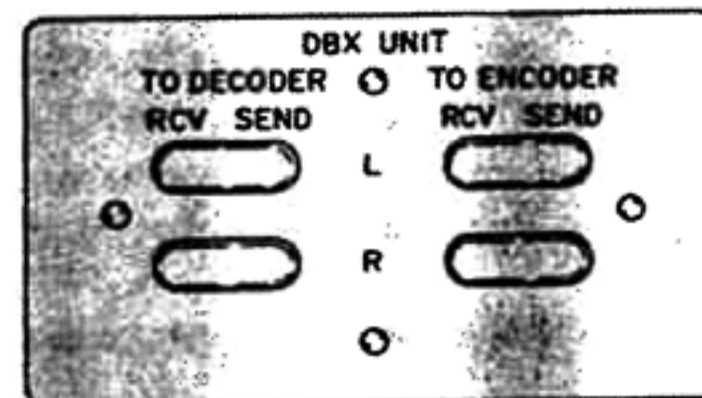

**27 DBX UNIT CONTROL SIGNAL Socket (X-10R only)**

These enable the optional DX-2A dbx noise reduction unit to be used with the X-10R for breath-taking dynamic range and signal-to-noise ratio. Full instructions for connecting the DX-2A are supplied with it. If the dbx unit is not being used, the special shorting links must be in place as in the illustration.

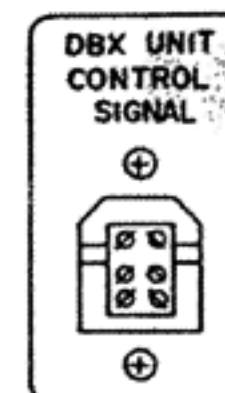



# Special Features

## Dual Capstan Closed-loop System

To record and playback tapes, the tape must stay in contact with the heads otherwise drop-outs and impaired performance will result. There are three ways of maintaining this contact — pressure pads, back tension and dual capstan closed-loop systems.

Of the three, pressure pads are the easiest to implement but the performance is generally considered unsatisfactory.

The back tension method is more complex but can give excellent results and has been much used by TEAC.

The most sophisticated method is the dual capstan closed-loop technique used in the X-10R and X-7R tape decks. The expertise and precision required has hitherto confined the method only to the costliest decks.

### How it works:

The tape is kept taut across the heads by having two pinch rollers/capstans which rotate at very slightly different speeds; the capstan near the take-up reel rotates faster than the one near the supply reel.

When the deck is used in reverse mode, the speed differential between the capstans has to reverse too. TEAC engineers invented a unique way to achieve this. The flywheels on the two capstans each have two zones of slightly different diameter. When the capstan motor reverses, the drive belt automatically repositions itself onto the correct areas of the flywheels to maintain the vital speed differential.

## Magnefloat Bearings

The bearings used on the capstans play a vital role in maintaining, or degrading, the wow and flutter performance of the deck. Vertical play is the problem and must be eliminated but the methods usually taken to overcome it — springs and other mechanical devices — often only make the problem worse.

The Magnefloat method uses the principle that like poles of a magnet oppose to keep the bearings firmly in place and eliminate vertical play with absolutely no mechanical contact. Result — wow and flutter are at an unprecedented low.

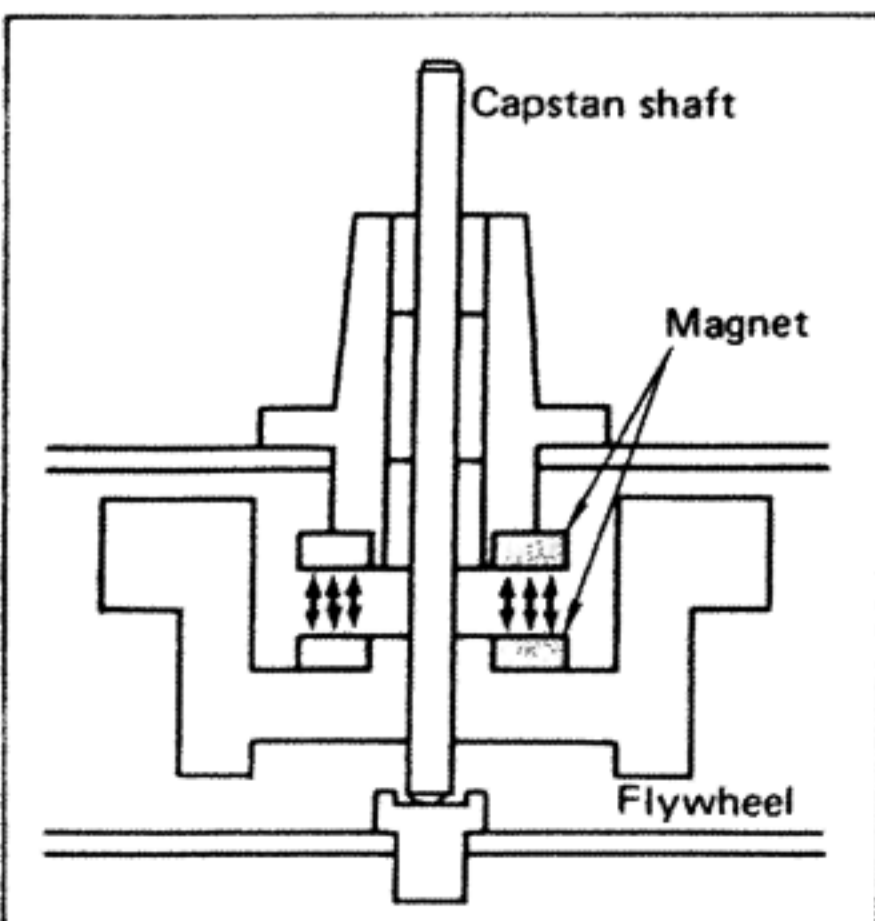

## Electrical Braking (X-10R only)

One of the advantages of large reel decks is that you can get longer play and record times. One of the disadvantages, up till now, has been that those large, heavy reels are also big on inertia and when it comes to stopping them, pretty hefty mechanical brakes were required. And the problem with heavy brakes is that hand-turning the reels for threading the tape, cueing etc. became a two hand job.

The X-10R, however, has electrical braking. That means that whenever the deck goes from a fast wind mode to any other mode, the tape is slowed down by sending a reverse polarity to the supply reel motor. A magnetoresistive motion sensing device monitors the speed of the tape, and when it is going slowly enough, a signal is sent to activate the mechanical reel brakes. Because the tape is only going slowly when the brakes are activated they can be very much lighter than conventional brakes and enable the reels to be easily turned using only one hand.

If you use your X-10R creatively you will do a lot of editing and that's when the advantages of electrical braking and light mechanical brakes will really tell.

## Real-time Pause (X-10R only)

Press the PAUSE control and you will notice that the pinch rollers retract only very slightly from the capstans and that the tape stays in contact with the heads. When you use the PAUSE, the tape stop and start times are so fast as to be virtually instantaneous; that's why we call it "real-time pause".

## Rack Mounting

For smart, professional appearance and space-saving convenience, rack mounting in standard 19 inch instrument racks is becoming increasingly popular. Rack mounting kits are available for both models, the RM-10 for the X-10R and the RM-7 for the X-7R. See page 12.

## dbx System Compatible (X-10R only)

The dbx noise reduction system is the breakthrough that can enable the real recording enthusiast to capture the full 100 dB dynamic range of live music on tape for the first time. The optional DX-2A brings more than just greater dynamic range, but even better signal-to-noise ratio too. Connection to the X-10R is simplified by means of the specially provided sockets on the rear panel.

## Sensing Foil

You will find in the included accessories some self-adhesive metal foil. It is necessary to use this foil at the end of any tape you wish to use in the bi-directional mode. This is because the auto-reverse facility is activated by the sensing post (mounted on the left inertia roller) detecting the metal. The foil must be stuck on the outer surface

of the tape — NOT the side of the tape in contact with the heads! It must be at the "end" of the tape, not at the "beginning", and it must be at the end of the magnetic portion of the tape just before the non-magnetic leader tape — NOT at the end of the leader tape itself.

## Two-way Cue Monitoring (X-10R only)

When you use the cue lever during fast wind, the sound recorded on the tape can be monitored if the MONITOR switch is in the TAPE position. Generally, if you are fast winding in the forward direction, you would want to monitor what's recorded on the "forward" tracks, tracks 1 & 3. However, if you wanted to check what was on the "other side of the tape", on tracks 2 & 4, it can be done as follows:

The green LEDs located above the forward and reverse play keys indicate if it is the forward tracks or the reverse tracks that are being monitored.

Suppose that the tape is fast rewinding but that the LED above the forward play button indicates that tracks 1 & 3 will be heard if the cue lever is pressed. To monitor the "reverse" tracks 2 & 4, all that has to be done is to hold down the fast rewind key and momentarily press the reverse play key. The LED over that key will now light up to indicate that the cue-monitoring mode has switched over to tracks 2 & 4. Using the cue lever will now enable these tracks to be checked instead.

To go back to monitoring tracks 1 & 3 without changing the direction of fast wind, hold down the fast rewind key and momentarily press the forward play key. The LED indication will change to show that once again it is the "forward" tracks that can be monitored.

## Erasing

When you make a new recording, the old one is automatically erased. However, erasing may easily be performed using the REC MUTE facility as previously described. To erase a whole reel of tape in this way would take quite some time and consequently bulk erasing is a technique much used by professionals. Using a bulk eraser such as the TEAC E-2, is faster and more thorough than erasing on the deck.

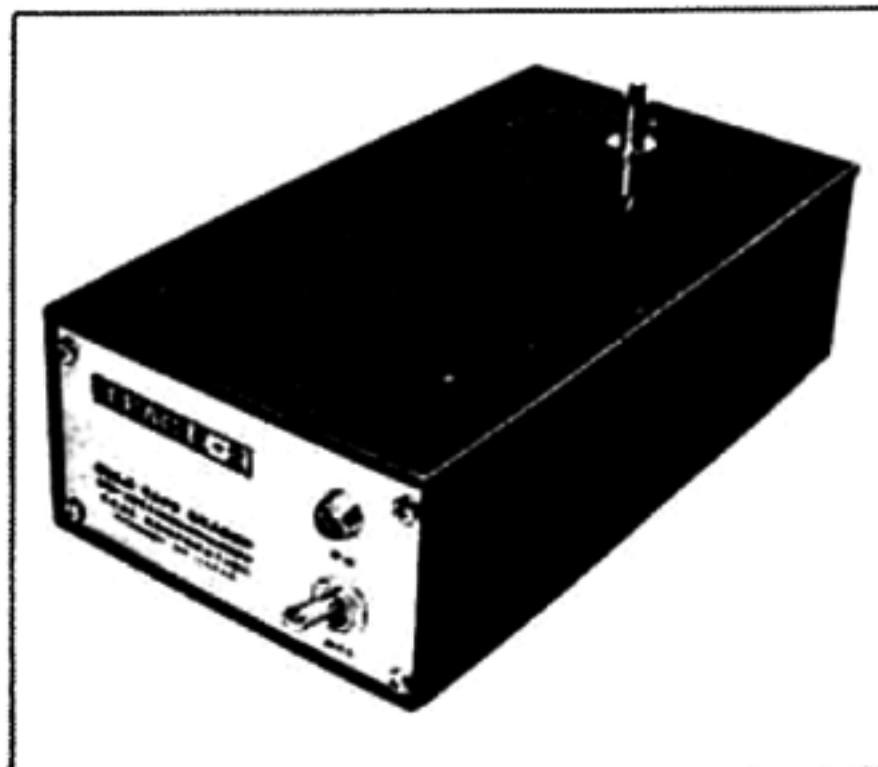

## Six Heads

Every quality tape deck has an erase, record and playback head – three in all. The X-10R and X-7R have six heads because they are like two separate tape decks in one; full erase, record, playback and monitoring facilities in the forward direction and

full erase, record, playback and monitoring facilities in the reverse direction. The two sets of heads have their track positions accurately aligned, one set for forward record and play and one set for reverse record and play.



## Clamping the Reels

It is vital to secure the reels firmly to the reel tables. 7 inch reels are clamped directly using the "QUIK-LOK" reel holders. Turning the top part of the reel holders counterclockwise lines up the tabs so that reels can be inserted and removed. Turn the top portion clockwise to "unalign" the tabs and lock the reel onto the reel table.

Large diameter 10-1/2 inch reels have large center holes and cannot be used directly on the reel tables. First you must fit the supplied reel adaptors (X-10R only)

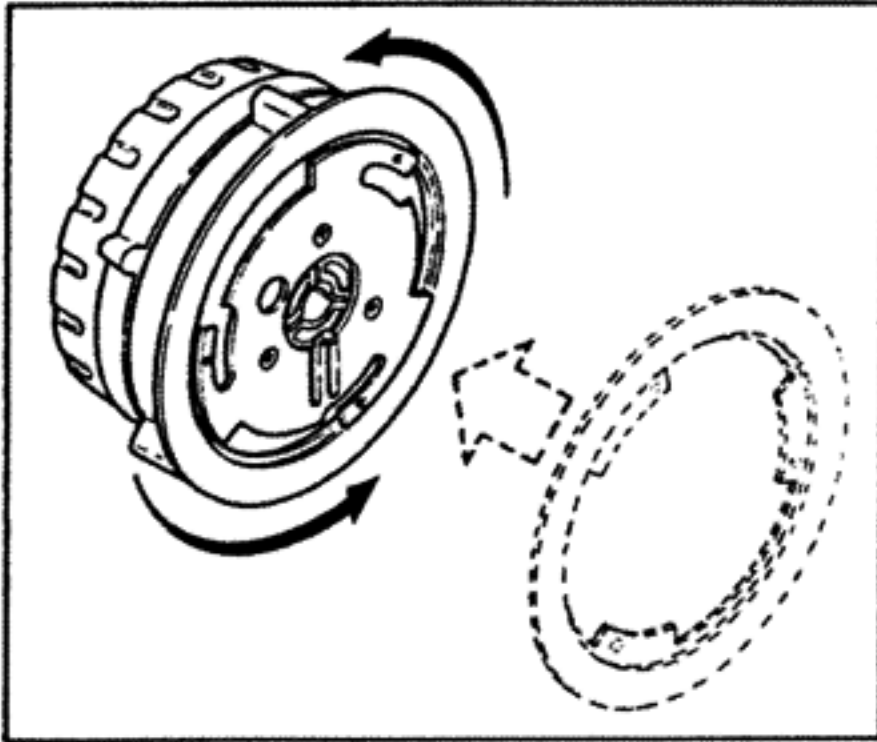

in exactly the same way as ordinary reels. When the reel adaptor is firmly in place, the large reels can be mounted as follows:

1. Rotate the outer part of the adaptor fully counterclockwise. This will line up the small tabs which fit into the three notches in the reels.
2. Insert the reels and rotate the outer part of the adaptor clockwise. This will "unalign" the tabs.
3. Continue turning the outer part clockwise until the tabs are drawn down tightly onto the reels.
4. Reels can be removed by reversing the above procedure.

Note: A metal spacer is mounted on the back of these reel adaptors and it must be in place when NAB standard 10-1/2 inch metal reels are used. For large plastic reels, this spacer must be removed. It twists out and twists in quite easily.

## Four Track Heads

The X-10R and X-7R have quarter track heads. That means each track recorded occupies approximately 1/4 of the track width. The two tracks of a stereo recording therefore occupy only half the tape width, enabling the tape to be recorded in the reverse direction. On ordinary decks, the user has to turn the tape over at the end of the tape, but with these decks the "other side" can be recorded by simply using the bi-directional record facility and recording on the tape in the reverse direction.

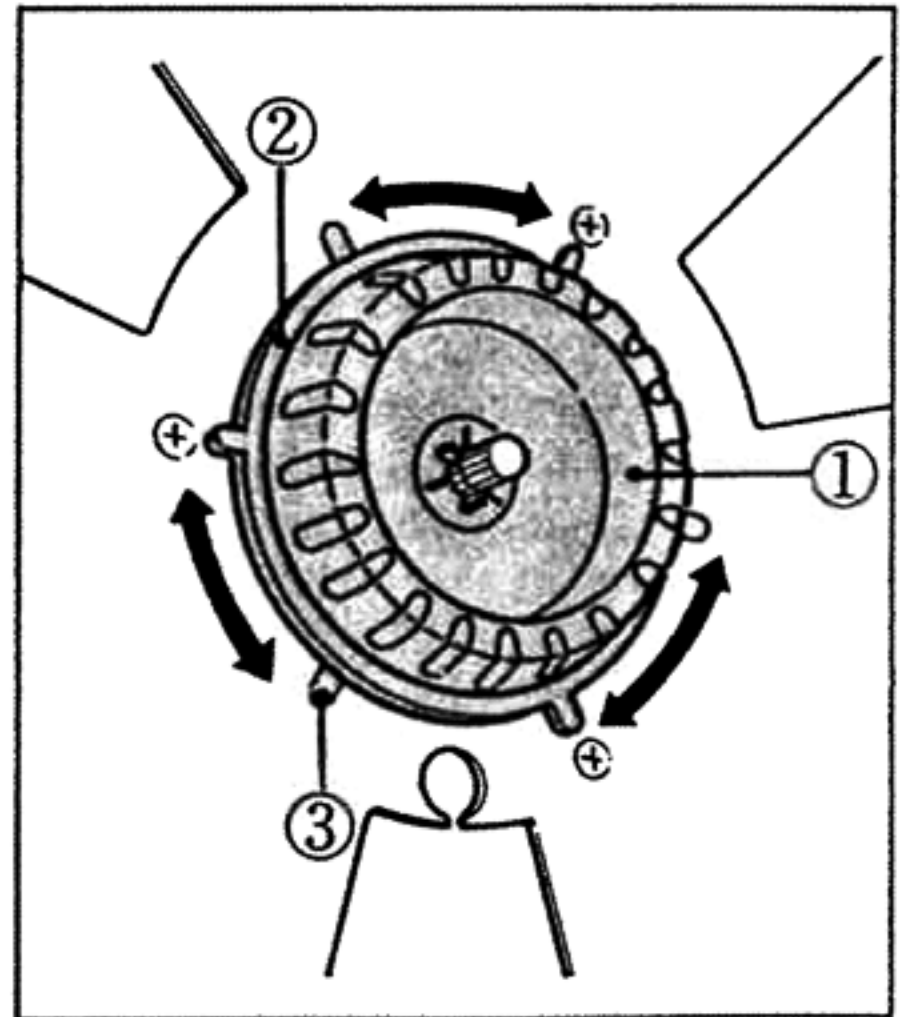
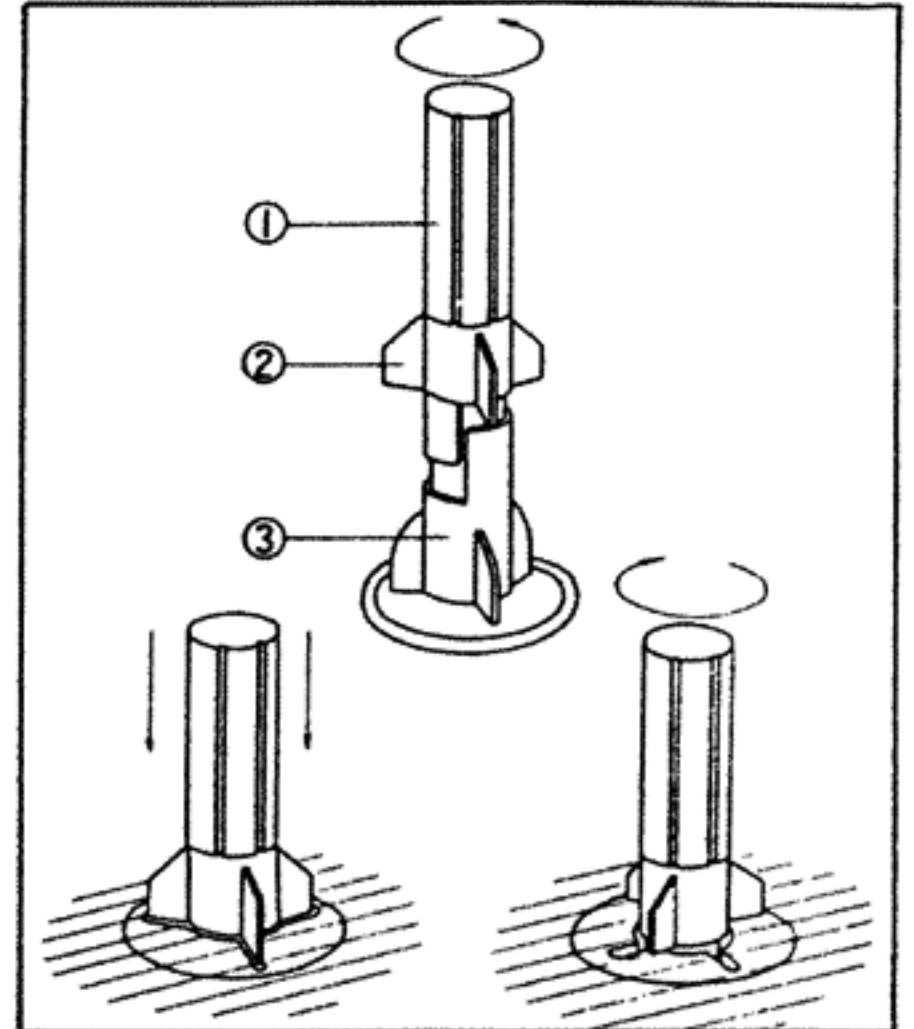

## Using the Meters to set the Recording Level

The meters, together with the LINE and MIC controls, form a vital combination for getting optimum recording quality from your deck. If the signal level fed to the tape during recording is too strong, it will cause the tape to saturate, resulting in severe distortion. On the other hand, if the signal is too weak, it will sound too quiet on playback. The volume will therefore have to be increased and this will result in more noise and hiss.

For best signal to noise ratio, therefore, the signal should be as high as possible without being high enough to cause tape saturation.

Before you make a recording, set the LINE or MIC controls so that the stronger signal you will be recording causes the needles on the meters to stay around the 0 VU region. Momentary excursions into the red area up to about +3 VU will cause no audible distortion but the MIC/LINE controls should not

be set so high that the needles are permanently in the red region. Neither should loud signals make the meters indicate over +3 VU, even briefly, as this will result in a harsh, rough sound indicative of tape saturation.

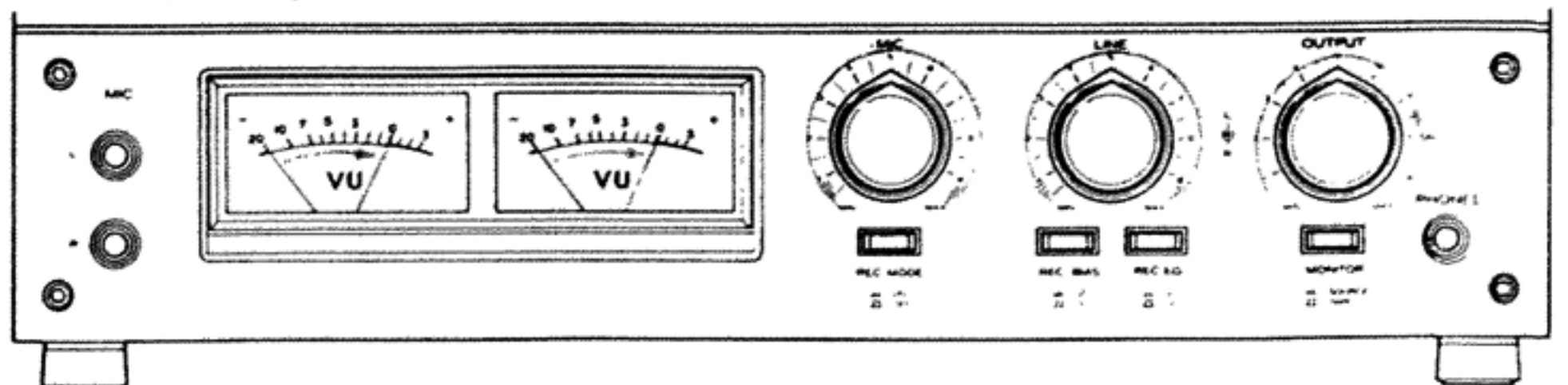

### Over Dubbing (Punch in Recording)

During playback, if the REC MODE switch is switched to ON, you can go directly from the playback mode to the record mode by holding in the RECORD key and pressing the play (◀) or (▶) key at the same time. The deck will begin recording from that location while the tape continues to move along. This operation is called "punch in" recording or "running splice". It allows you to record over or correct a recorded section of the tape without stopping the tape.

### Dubbing

Deck-to-deck copying of tapes (dubbing) can be done without using an external amplifier. Operation is the same as standard record and playback procedure as described in the record and playback section.

Either deck can be used as the "master" recorder with a second recorder used as the "slave" recorder. Connect the output of the either X-10R or X-7R to the input of the slave recorder.

To use either the X-10R or X-7R and the second recorder in opposite roles, simply reverse the input and output connections.

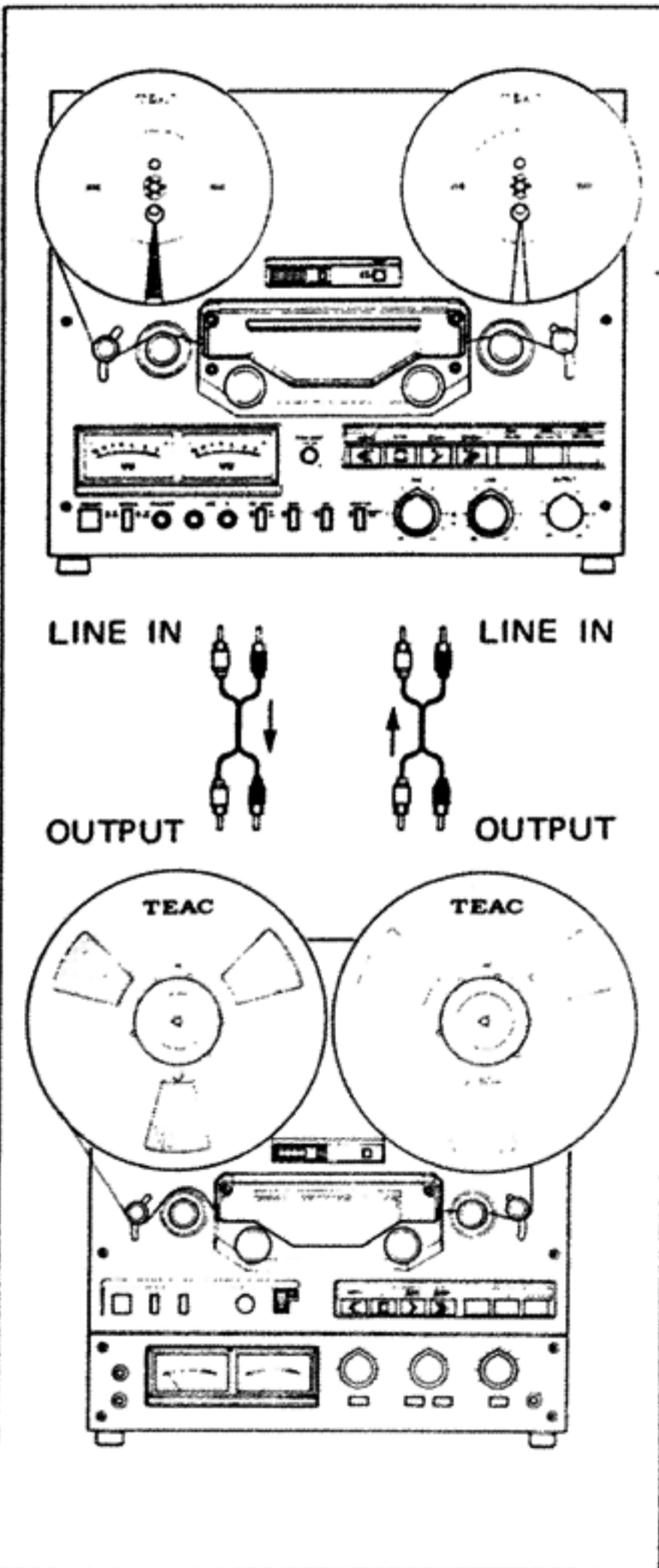

### BIAS and EQ Setting Chart

| BRAND   | TAPE DESIGNATION   | SWITCH POSITION |        |
|---|--|-----------------|--------|
|   |  | REC BIAS        | REC EQ |
| AMPEX<br>BASF<br>DENON<br>FUJI<br>MAXELL<br>SCOTCH<br>SONY<br>TDK | 456<br>SP-54R<br>DX Series<br>FB<br>UD-XL, UD, New-LN<br>250, 1500, MASTER<br>DUAD, SLH, ULH<br>L Series (AUDUA) | □ 1             | □ 1    |
| AGFA<br>AMPEX<br>BASF<br>FUJI<br>SCOTCH                           | PE-36, PER-525, PER-555<br>406, 407<br>SPR-50LH, LGR-30P<br>FG<br>206, 207, 218                                  | □ 1             | ▢ 2    |
| BASF<br>SCOTCH  | LP-35LH, LP-35LHS, LPR-35LH<br>211, 212, 176, 177, 228, 229  | ▢ 2             | □ 1    |
| FUJI<br>MAXELL<br>TDK   | FM<br>LN, ST<br>T Series, S Series   | ▢ 2             | ▢ 2    |

### TIMER Recording and Playback Connections (Connections to a stereo system, Playback through an amplifier)

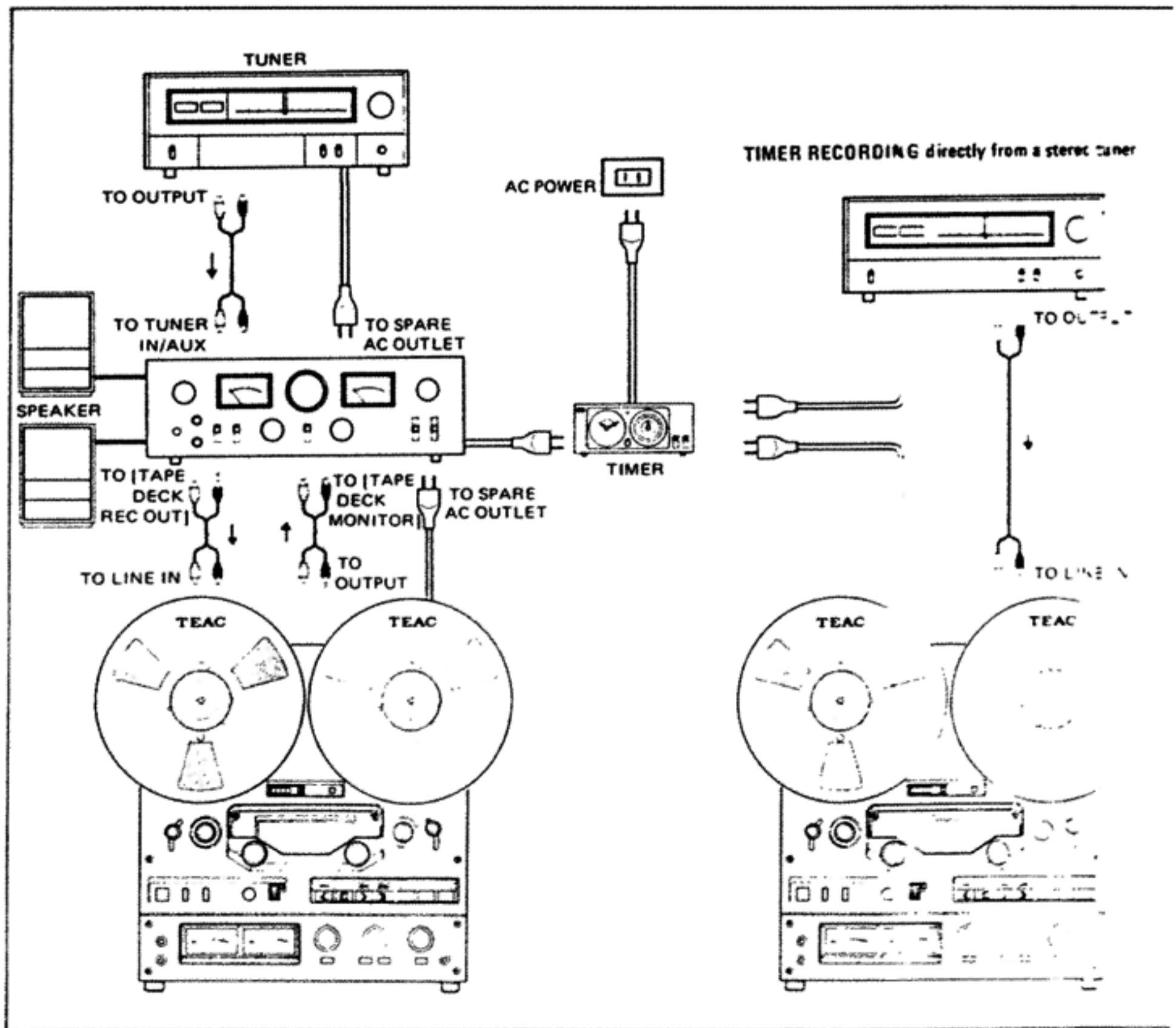

## Maintenance

### Cleaning

#### Heads

When the tape deck is used for a long time magnetic oxide from the tape, dirt and dust tend to accumulate on the heads and along the tape movement path. If this happens, the sound quality will begin to worsen, high frequency response will suffer, there will be a loss of output level and drop-outs will occur. Eventually the heads may begin to wear unevenly and much quicker than normal. At an extreme condition, the heads may not be able to erase, record or playback at all.

To avoid this unnecessary problem the heads and tape path must be cleaned regularly, at least after about every 8 hours of record or playback operations and before every important recording session. Especially clean the heads and pinch rollers and capstan shafts. TEAC produces a special kit called TZ-261 which contains rubber and head cleaning fluids. If this kit is not available, pure alcohol may be used or similar tape recorder cleaning fluids which are made and recommended by reputable manufacturers may be used.

#### Pinch Rollers and Capstan Shafts

The pinch rollers and capstan shafts have been called the heart of the transport and well they might be. If they become dirty, wow and flutter will increase and tape movement may become erratic. These parts should be cleaned whenever you clean the heads. Use the TZ-261B fluid for cleaning the pinch rollers.

### Maintenance Accessories Tape Recorder Cleaner (sold separately) TZ-261



**Note:** The front panel and other external parts may be cleaned with a cloth dampened with weak, neutral detergent solution. NEVER use benzine or other organic solvents.

• For more information on maintenance and tape handling, etc., refer to the Information Supplement.

## Specifications

|                                 | X-10R  | X-7R   |
|---------------------------------|--|--|
| Track System                    | 4 Track, 2 Channel Stereo  | ←  |
| Head System                     | 6 Heads: Forward Erase, Forward Record, Reverse Playback, Forward Playback, Reverse Record, Reverse Erase.               | ←  |
| Reel Size                       | 10-1/2" and 7"   | 7" and 5"  |
| Tape Speed                      | 7-1/2 ips and 3-3/4 ips (±0.5%)  | ←  |
| Motors                          | Capstan Motor: DC Brush Motor with FG Servo<br>Reel Motor: 2 DC Slotless Motors  | ←  |
| Wow and Flutter (NAB Weighted)  | 0.03 % at 7-1/2 ips<br>0.04 % at 3-3/4 ips   | ←  |
| Frequency Response (Overall)    | 30 - 28,000 Hz (±3 dB, 40 - 20,000 Hz -10 VU) at 7-1/2 ips<br>30 - 20,000 Hz (±3 dB, 40 - 16,000 Hz -20 VU) at 3-3/4 ips | ←  |
| Signal-to-Noise Ratio (Overall) | 63 dB (3 % THD Level, Weighted)  | ←  |
| Harmonic Distortion (Overall)   | 0.8 % at 1,000 Hz normal operating level   | ←  |
| Stereo Channel Separation       | 50 dB at 1,000 Hz  | ←  |
| Fast Wind Time                  | 100 seconds for 1,800 feet   | ←  |
| Inputs                          | Line: 60 mV, 50 kohms<br>Microphone: 0.25 mV/-72 dB (200 ohms or more)   | ←  |
| Outputs                         | Line: 0.45 V for load impedance of 10 kohms or more<br>Headphones: 8 ohms  | ←  |
| Power Requirements              | 117 V AC, 60 Hz, 88 W  | 117 V AC, 60 Hz, 77 W  |
| Dimensions (WHD)                | 432 x 440 x 210 mm (17.0" x 17-5/16" x 8-1/4")   | 432 x 364 x 262 mm (17.0" x 14-5/16" x 10-5/16")                                     |
| Weight                          | 20 kg (44-1/16 lbs) net  | 18 kg (39-11/16 lbs) net   |
| *DBX Terminal                   | For connection to optional DX-2A dbx unit.   | —  |
| Standard Accessories            | Empty Reel (RE-1002)<br>Reel Adaptors (TZ-612A)<br>Input-output Connection Cords<br>Splicing Tape<br>Sensing Tape        | Empty Reel (RE-702)<br>Input-output Connection Cord<br>Splicing Tape<br>Sensing Tape |

• Specifications were determined using low noise/high-output tape.

• Improvements may result in specifications or features change without notice.

\* dbx noise reduction system made under license from dbx, Incorporated. The word dbx and the dt symbol are trademarks of dbx, Incorporated.

# Optional Accessories

**EIA Rack Mount Kit RM-10**  
For mounting the X-10R series in EIA racks.

**EIA Rack Mount Kit RM-50**  
For installing the DX-2A dbx Unit in a 19" EIA rack.

**EIA Rack Mount Blank Panel RM-53**  
A panel for spacing the X-10R series deck and other components when installed in an EIA rack.

**TZ-550 Dust Cover**  
Smoked acrylic cover for the X series for dust protection.

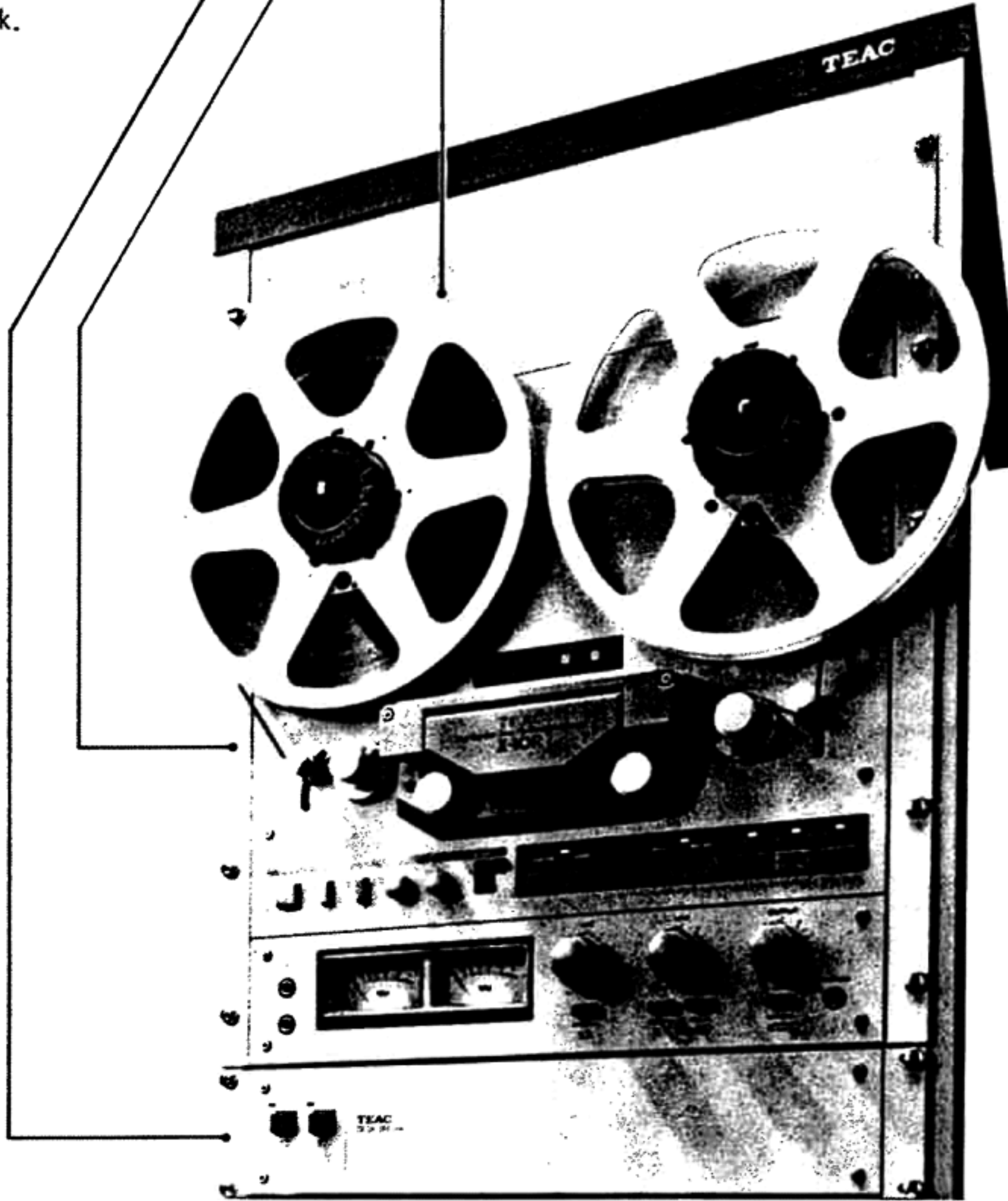

## Tape Deck Stand CS-606



## Rack Mounting

For smart, professional appearance and space-saving convenience, rack mounting in standard 19 inch instrument rack is becoming increasingly popular. Rack mounting kits are available for both models, the

RM-10 for the X-10R and the RM-7 for the X-7R. They are quick and easy to use and can make the fantastic looks of your deck even better.

## dbx Unit DX-2A



## Remote Control Unit RC-100

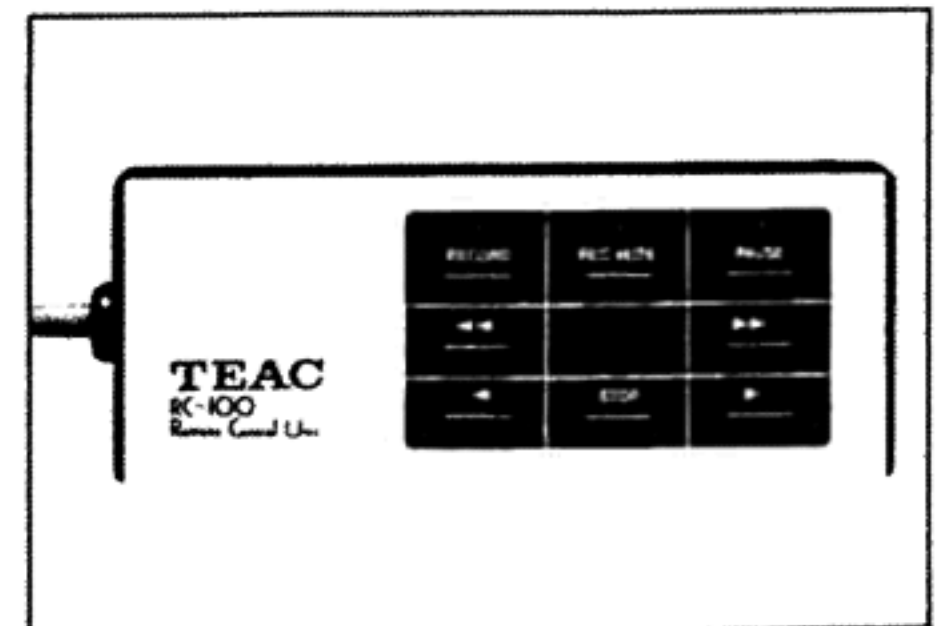

**X-10R/X-7R**

**TEAC**<sup>®</sup>  
First. Because they last.

---

**TEAC CORPORATION**

3-7-3 NAKA-CHO MUSASHINO TOKYO PHONE (0422) 53-1111

TEAC CORPORATION OF AMERICA

7733 TELEGRAPH ROAD MONTEBELLO CALIFORNIA 90640 PHONE (213) 726-0303

TEAC AUSTRALIA PTY., LTD.

165-167 GLADSTONE STREET SOUTH MELBOURNE VICTORIA 3205 PHONE 699-6000

PRINTED IN JAPAN 0579U1-D-3172A