

SANSUI

8080DB STEREO RECEIVER
RECEPTEUR STÉRÉO
STEREOEMPFÄNGER



**OPERATING INSTRUCTIONS
MODE D'EMPLOI
BETRIEBSANLEITUNG**

WARNING: To prevent fire or shock hazard, do not expose this appliance to rain or moisture.

ATTENTION: Pour éviter les dangers d'électrocution ou d'incendie, ne pas exposer cet appareil à la pluie ou à l'humidité.

WARNUNG: Setzen Sie dieses Gerät zur Verhütung von Feuer- und Stromschlaggefahr weder Regen noch Feuchtigkeit aus.

We are grateful for your choice of this fine Sansui high fidelity **product**. This model offers a built-in Dolby Noise Reduction system, **direct** readout power meters, and a host of other highly advanced functional features. We suggest that you read this booklet of operating instructions carefully, so that you may connect it and operate it correctly for years to come.

Table of contents

PRECAUTIONS
CONNECTION
PANEL INFORMATION
ABOUT DOLBY NR
OPERATING PROCEDURES
SOME USEFUL HINTS
SPECIFICATIONS

PRECAUTIONS

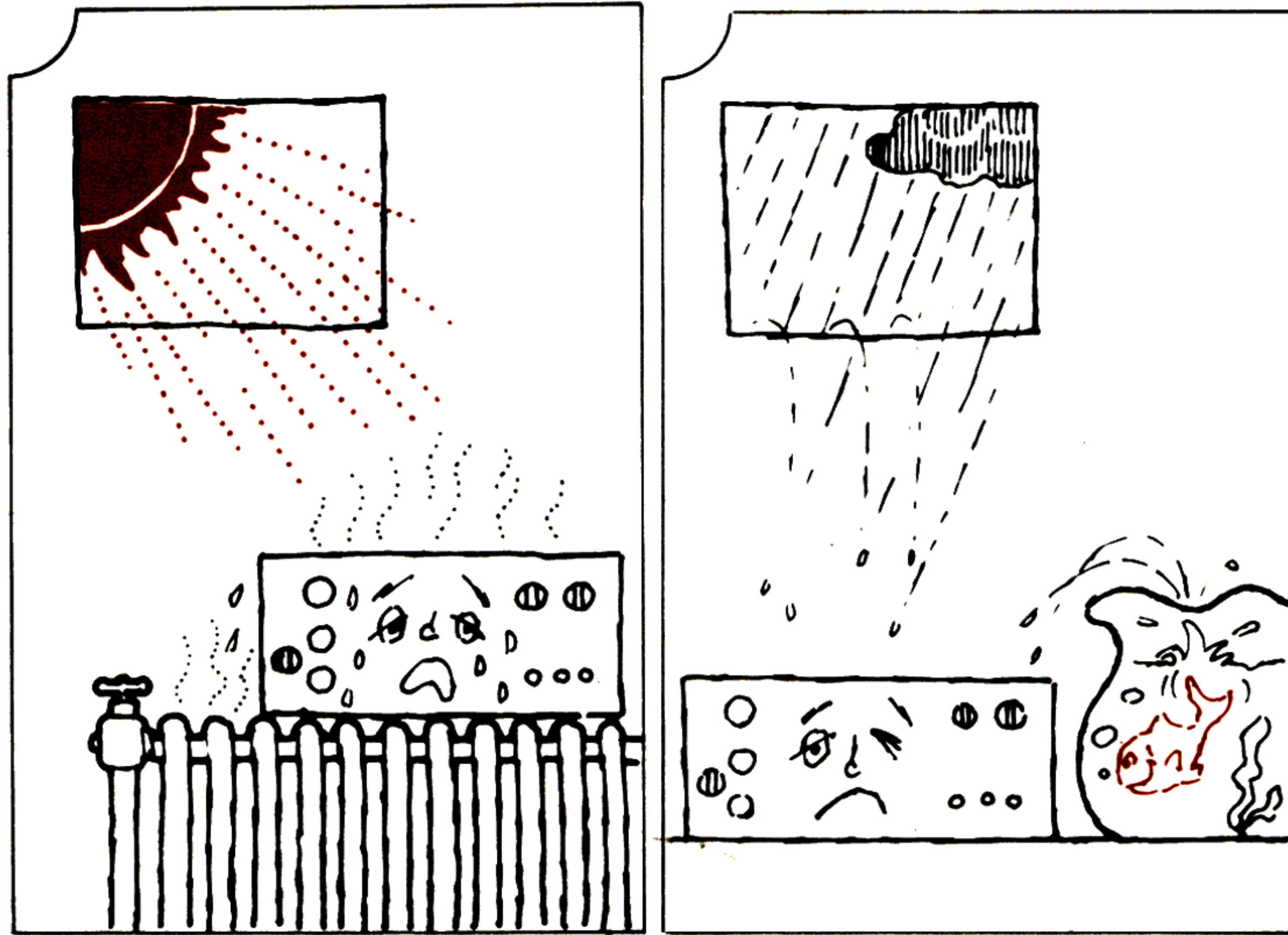

Note

- * Don't remove the cabinet cover or bottom board of the unit.

Installation

- * Never install the unit in dusty or humid locations, or in close proximity to heating appliances. Also, do not place it near a flower basin or fish bowl, for accidental spillover may cause fire, electrical shock and/or breakdown.
- * Keep the unit away from TV sets to avoid buzz noise.
- * When mounting the unit on a shelf, be sure that its supports are solidly fixed.

Connection

- * When connecting or re-locating the unit, be sure to turn the power off or disconnect the power cable.
- * Be sure not to confuse the right channel with the left, plus cables with minus or inputs with outputs. Check each step carefully.
- * Use connection cords of dependable quality. Check that connections are secure and that leads of connection are not frayed or in contact with other objects. Poor connection may cause hum noise or breakdown.
- * Short pin-plugs (supplied) should be inserted into unused PHONO terminals, never into other terminals, for they may interrupt sound coming from speakers.
- * Do not touch the rear panel heat sink. Also check that connection cords are not in contact with the heat sink, as it is dangerous.

NOTE: No AC outlet is provided on units sold in some areas owing to local laws and regulations.

REMARQUE: Aucune sortie AC (Courant Alternatif) n'équipe les modèles vendus dans certaines régions en raison des règlements locaux.

ANMERKUNG: Aufgrund örtlicher Vorschriften und Gesetze sind in manche Gebiete gelieferte Geräte nicht mit Wechselstrombuchsen ausgestattet.

AC outlets

Of the two AC outlets provided on the rear panel, the one marked SWITCHED, is controlled by the front-panel power switch. The other one, marked UNSWITCHED, is not related to the power switch. The former has a capacity of 100 watts and the latter 150 watts. Do not connect any component whose power consumption exceeds these capacities, as it is extremely dangerous.

The power consumption rating is usually listed in the specifications or instructions of the component, or on the equipment itself; be sure to check the rating.

- In case you have connected a component to one of the unit's AC outlets and then another component to the first component's outlet, be sure to add the second component's rated power consumption to the consumption of the component connected to the unit itself.

Speaker connections

Up to three pairs of speaker systems can be connected to this unit, and selected by operating the front-panel SPEAKERS switch. But if this switch is set at A + B or A + C, no sound will be heard unless both pairs of speaker systems are connected to the unit. Also, if you use speaker systems whose impedances are 4 ohms or less each, it may cause this unit to break down. Be sure to check out the impedance of a speaker system (usually indicated on its name plate or operating manual) before you connect it to this unit.

Ventilation

Breakdown may occur when you use the unit over a long period of time with ventilation holes on its bottom and top panels obstructed. Pay extra attention when placing objects atop the unit, and when rack-mounting the unit.

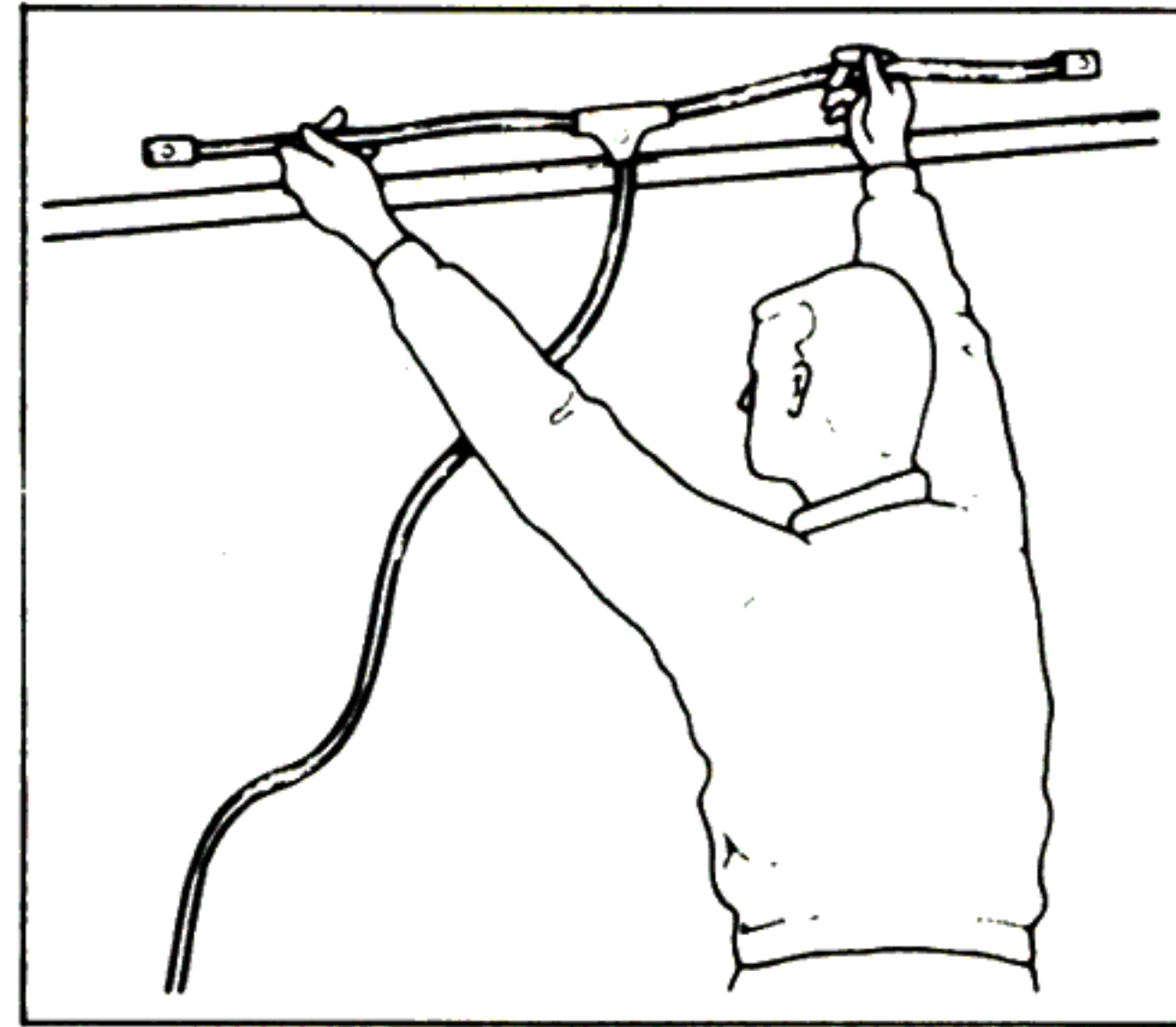
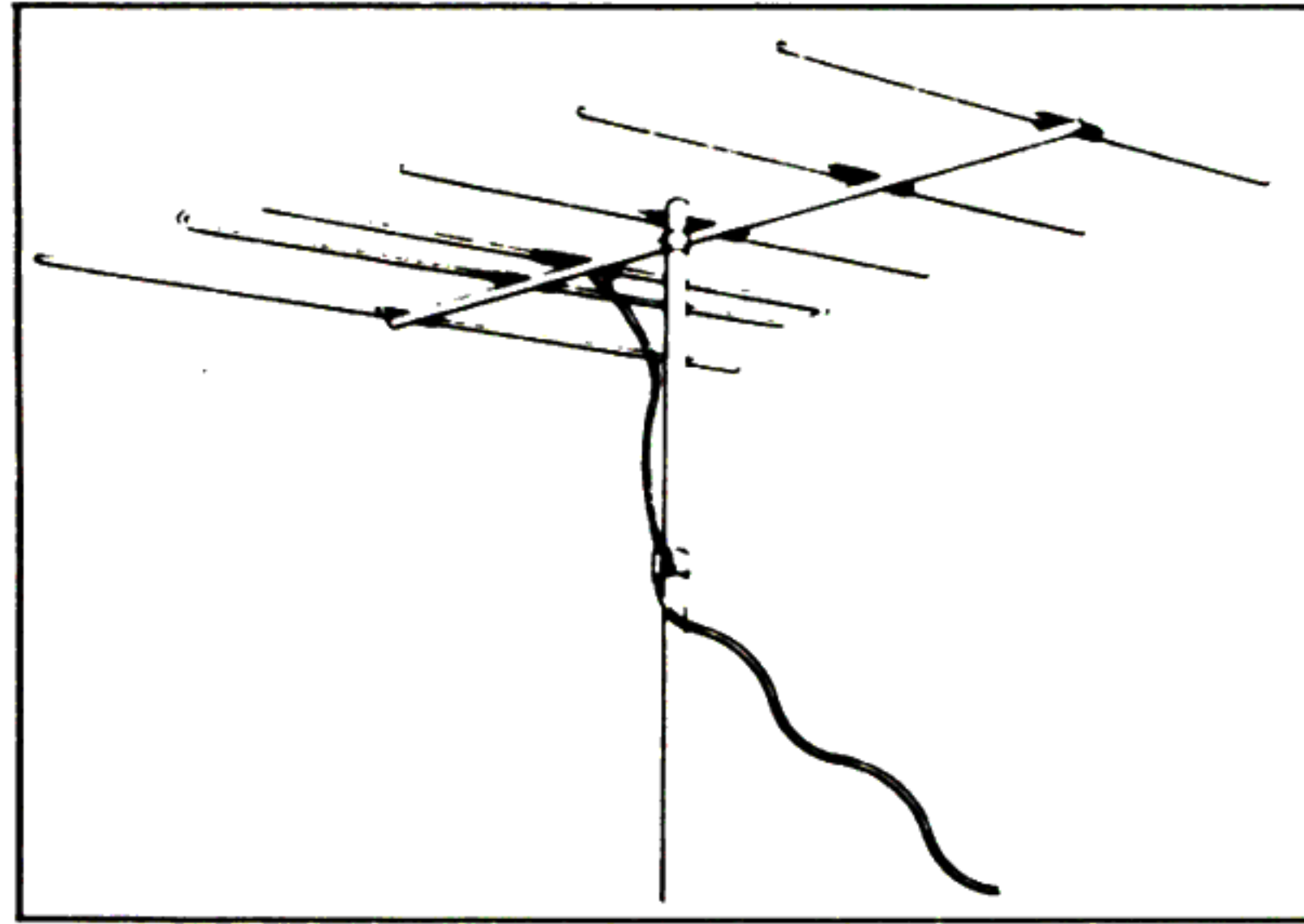

Turn it to left and right.
 La tourner à gauche et à droite.
 Nach rechts oder links drehen.

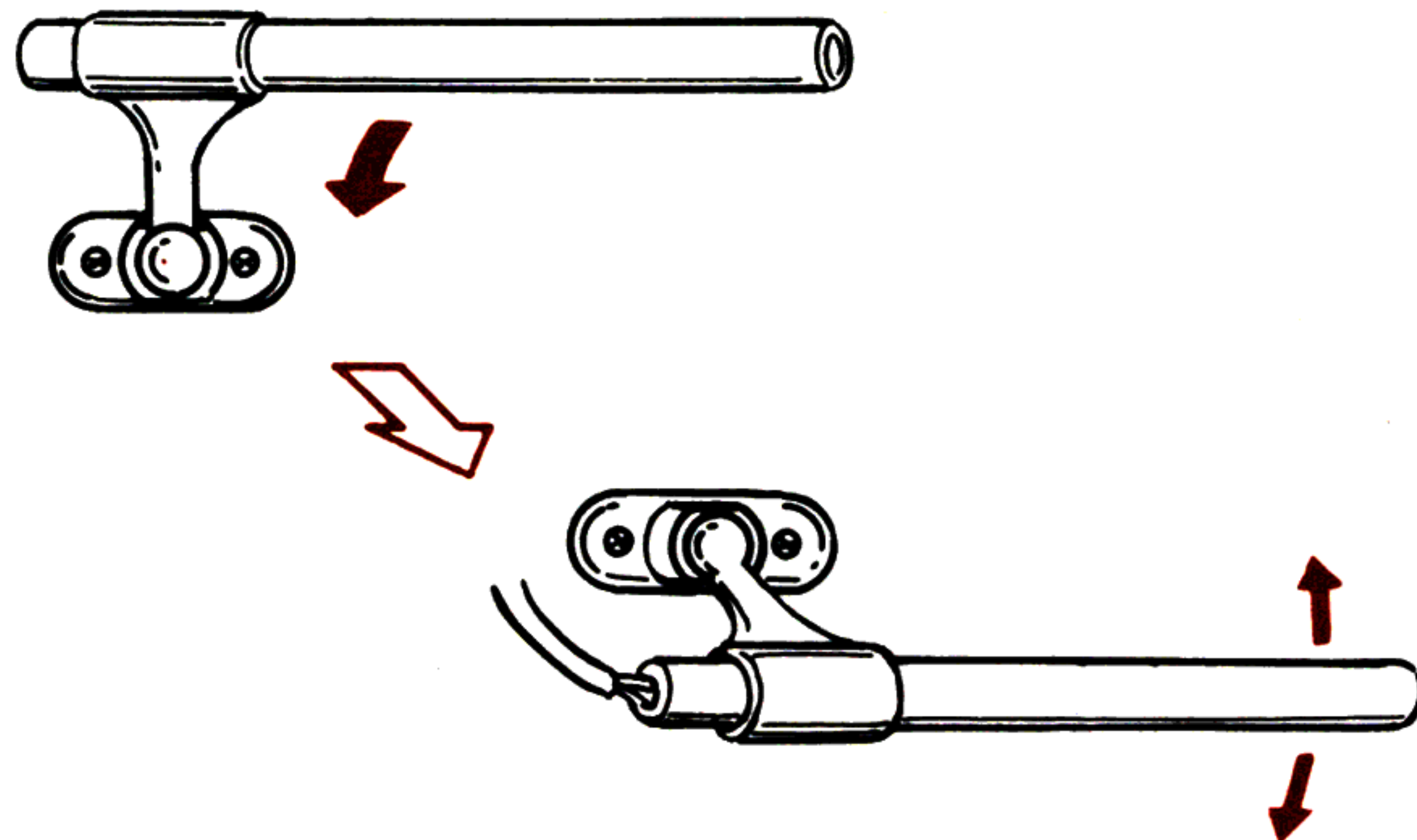

FM antenna installation

1. The antenna should be installed as high and as far away as possible from the street, railroad tracks and high-tension lines which can cause noise.
2. If the horizontally-extended part of the attached T-shaped antenna is not raised high enough, reproduction may be unstable, since signal paths are interrupted every time a person walks in the vicinity of the antenna.
3. The lead-in cable should be as short and as far away from power lines as possible. Simply cut off the extra length, if any. Be sure not to bundle it into a coil.
4. FM antennas possess directionality. Install a highly directional type antenna for improved noise-free reception.

Outdoor FM antenna

The antenna is a vital factor for low noise high sound quality FM reception. Install an outdoor FM antenna as described on pages 40, 41, 42 and 43.

AM antenna installation

While actually listening to an AM station, pull the rear-panel bar antenna and align in the direction where you get the best reception. To avoid noise, do not run the power cable or speaker cables in the vicinity of the antenna.

Further advice for better AM reception:

1. Move the antenna away from the wall.
2. Place the unit near the window.
3. Re-align the unit itself.
4. Connect a PVC cord to the AM ANTENNA terminal and extend it outdoors.

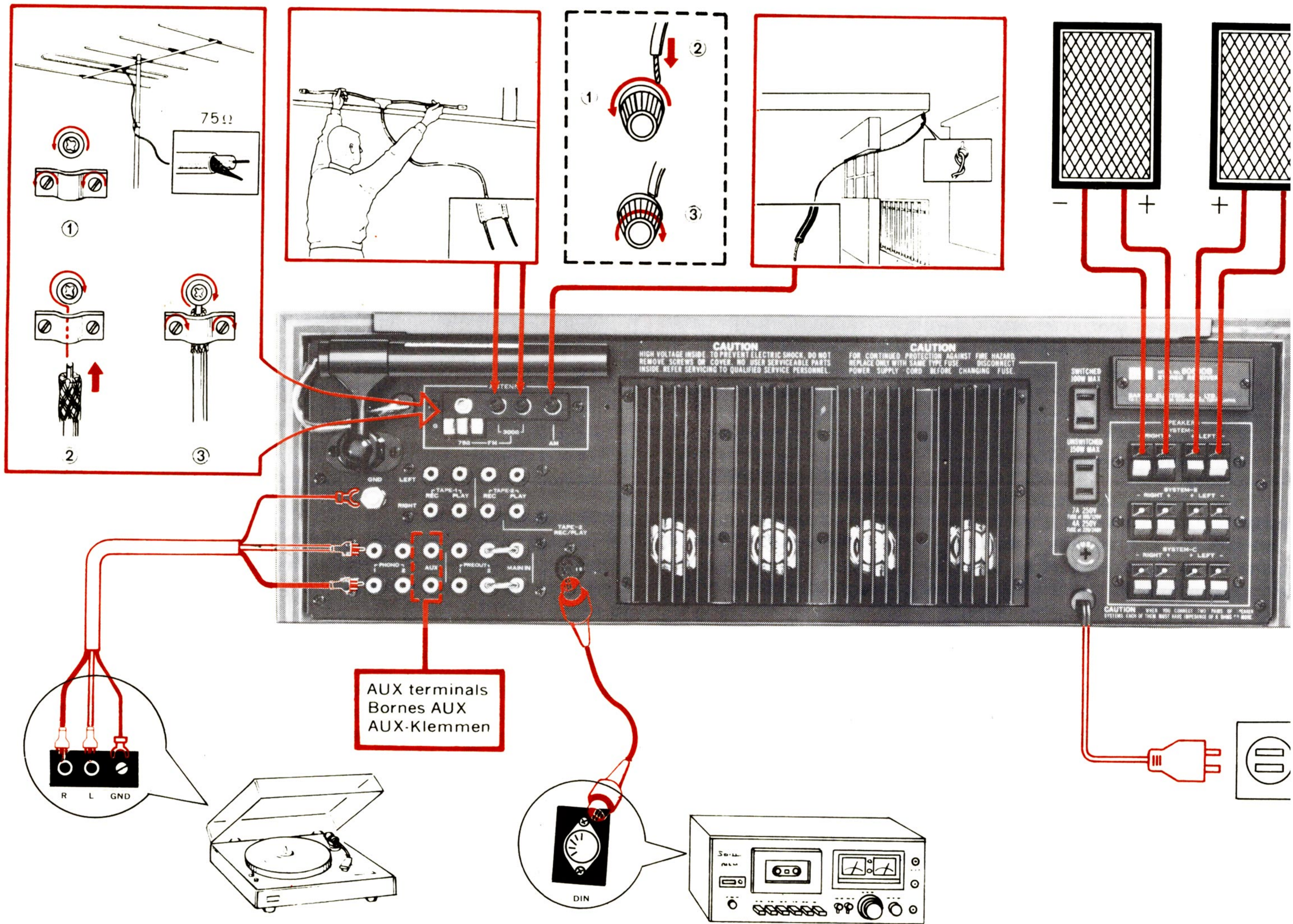

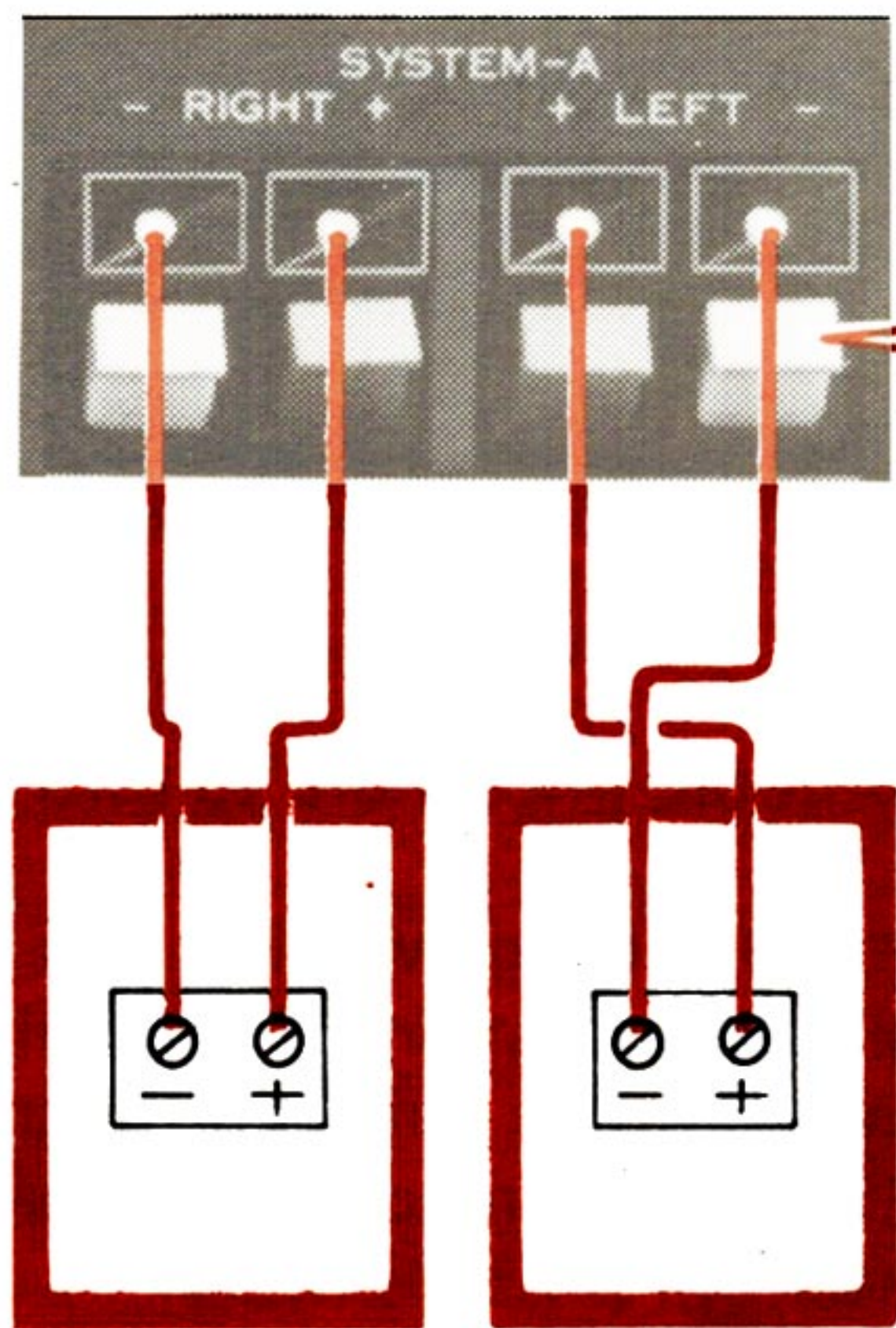

Push button, insert lead wires of cord, and release.
 Pousser le bouton, insérer les fils conducteurs du cordon, et relâcher.
 Drücken Sie die Taste, schieben Sie den Leiter des Kabels ein und lassen Sie los.

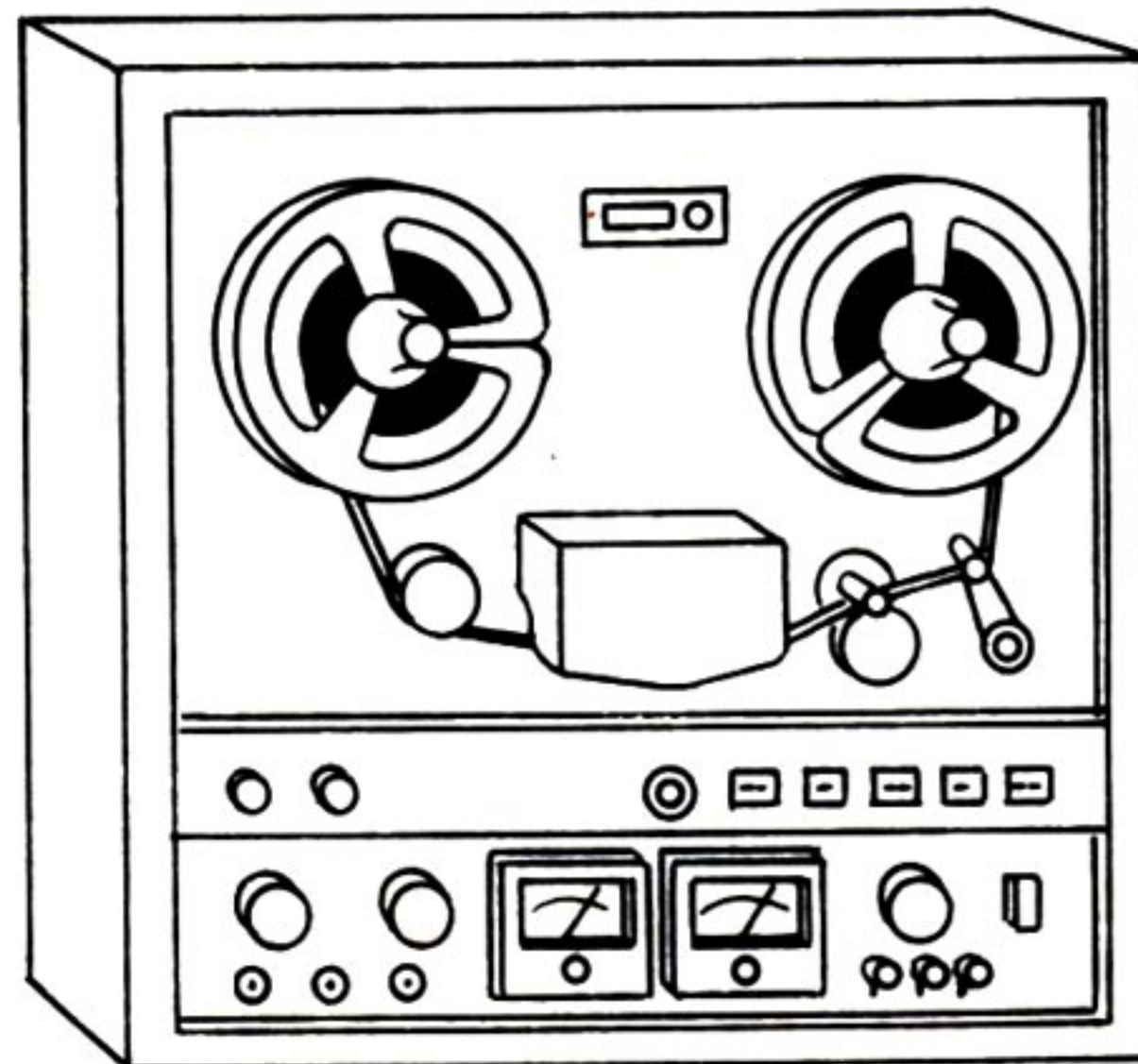
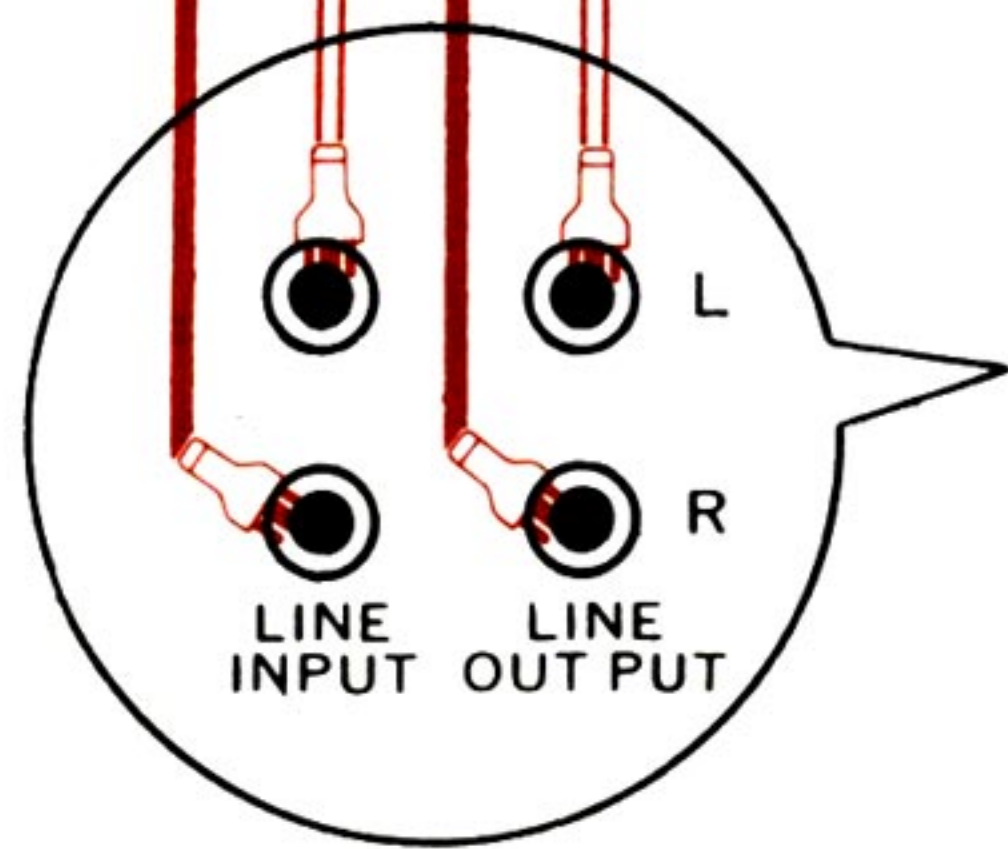
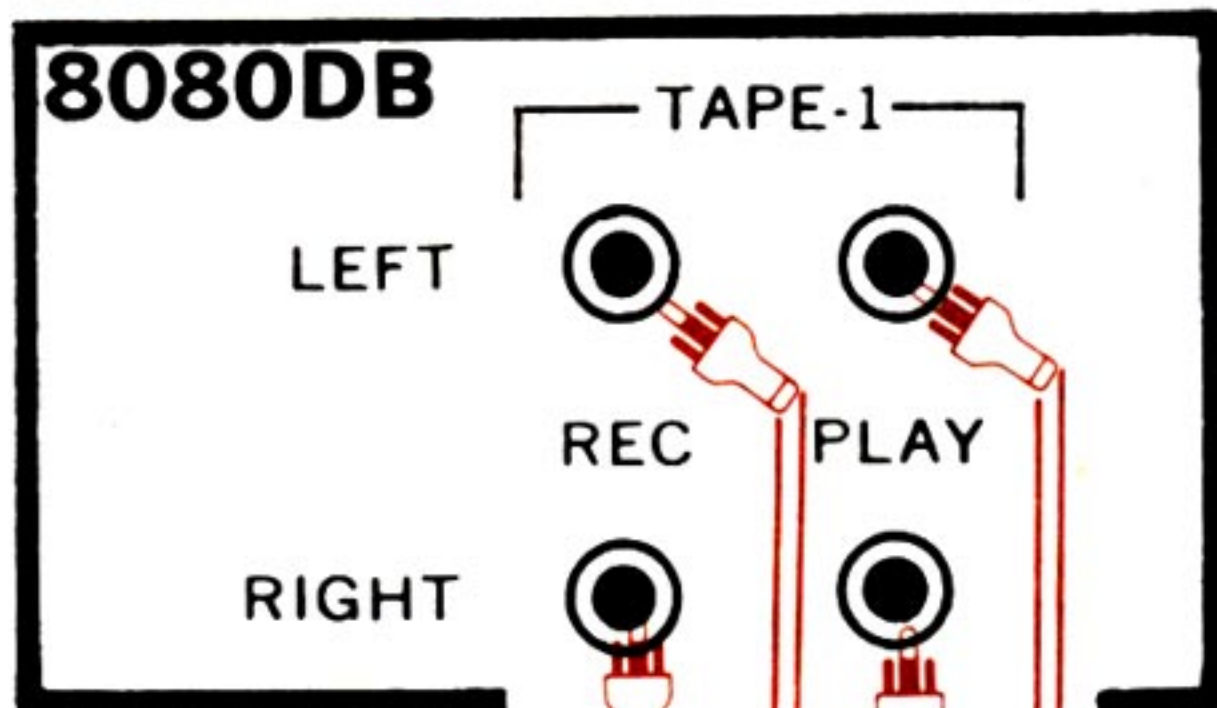
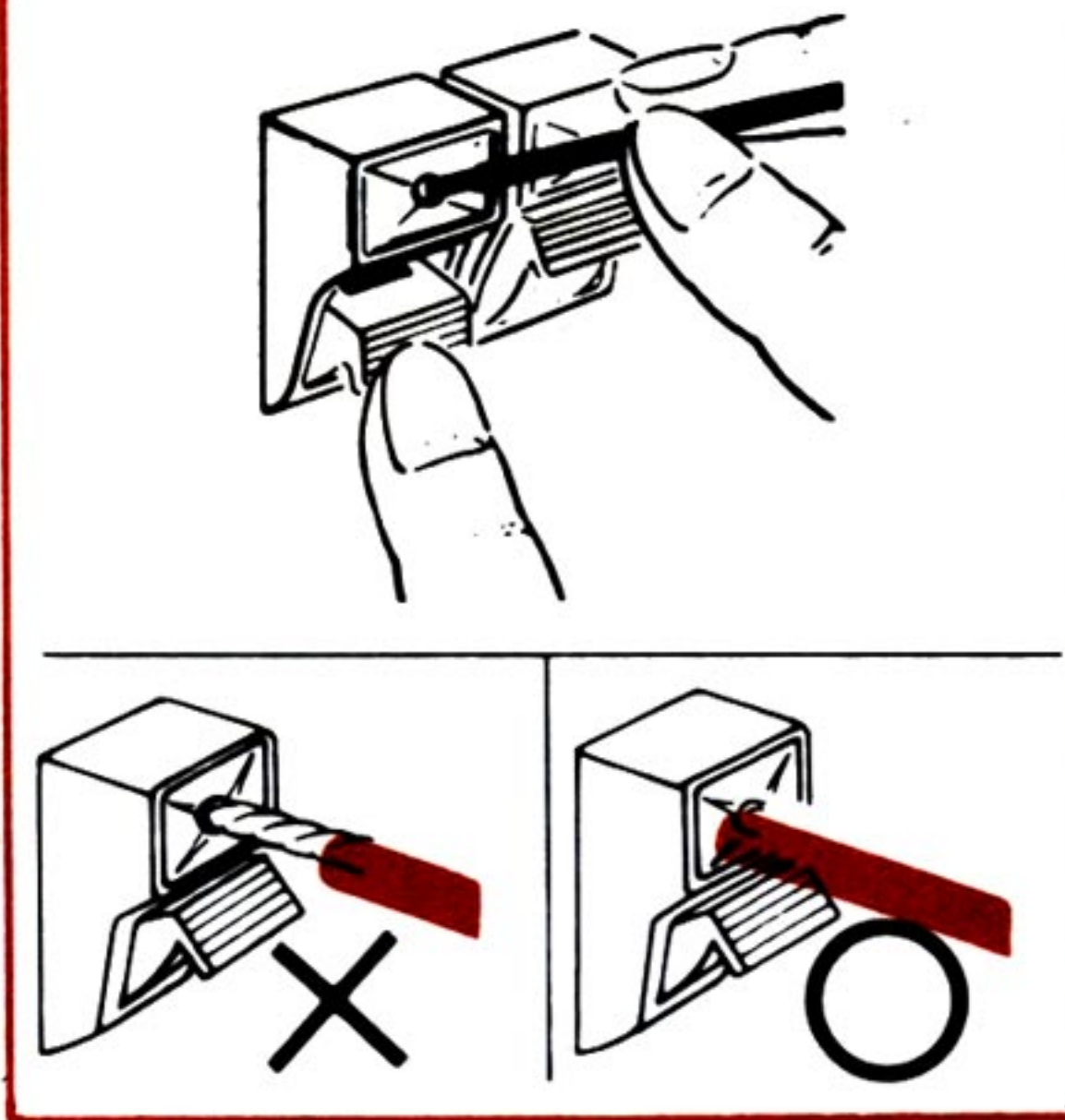

* Instructions and requirements indicated may vary to some extent depending on sales area, local laws and regulations.

* Les instructions et les obligations indiquées peuvent varier suivant la région, les lois et les règlements locaux.

* Die Anleitungen und angegebenen Werte können in Abhängigkeit vom Verkaufsgebiet und den örtlichen Gesetzen etwas abweichen.

Speaker connection

To SPEAKERS SYSTEM -A, -B or -C terminals, connect speaker cords taking care not to confuse the right channel with the left and plus polarity with minus.

FM antenna connection

Use the FM 300-ohm terminals when connecting the T-shaped FM feeder antenna supplied or a 300-ohm lead-in cable from an outdoor antenna.

Use the FM 75-ohm terminal when connecting a 75-ohm coaxial cable from an outdoor antenna.

AM antenna connection

Connect a PVC cord to the AM ANTENNA terminal and extend the other end outdoors.

Turntable connection

Connect your turntable to the PHONO-1 terminals. When using two turntables or two tonearms, use the PHONO-2 terminals too. When your turntable is equipped with a grounding cable, connect it to the unit's GND terminal. But disconnect it when you notice increased hum.

Tape deck connection

You can connect up to two tape decks to the unit. Connect the unit's TAPE REC terminals to the line input terminals of your tape deck, and the unit's TAPE PLAY terminals to the output terminals of the deck. The DIN socket connects with the identical socket on your tape deck via a DIN cable.

- The TAPE-2 circuit is duplicated, one by pin jacks and the other by the DIN socket. Do not use the jacks and the socket at the same time.

- ▶ For information about the AUX and PRE OUT/MAIN IN terminals, refer to the section "SOME USEFUL HINTS".

- This page folds out for use as reference while reading the rest of the booklet.

- Cette page se plie à l'extérieur pour l'utiliser comme référence tout en lisant le reste de la notice.

- Bitte klappen Sie diese Seite heraus, wenn Sie den Rest dieser Anleitung durchlesen.

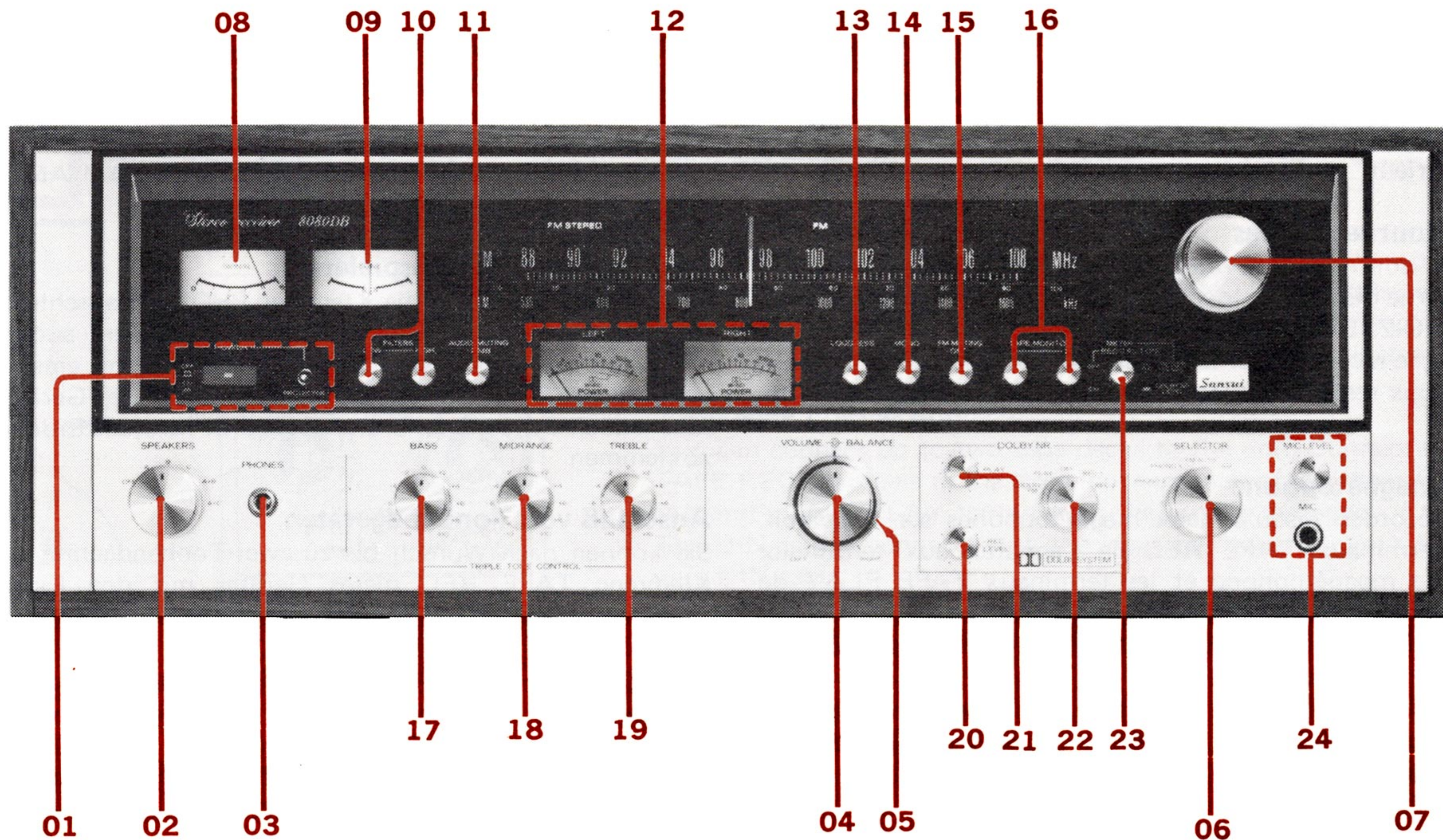

PANEL INFORMATION

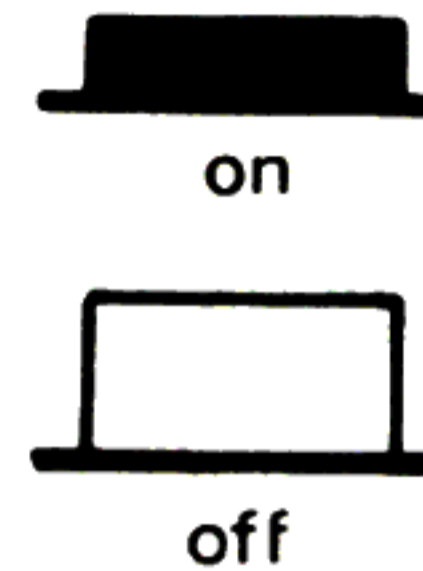
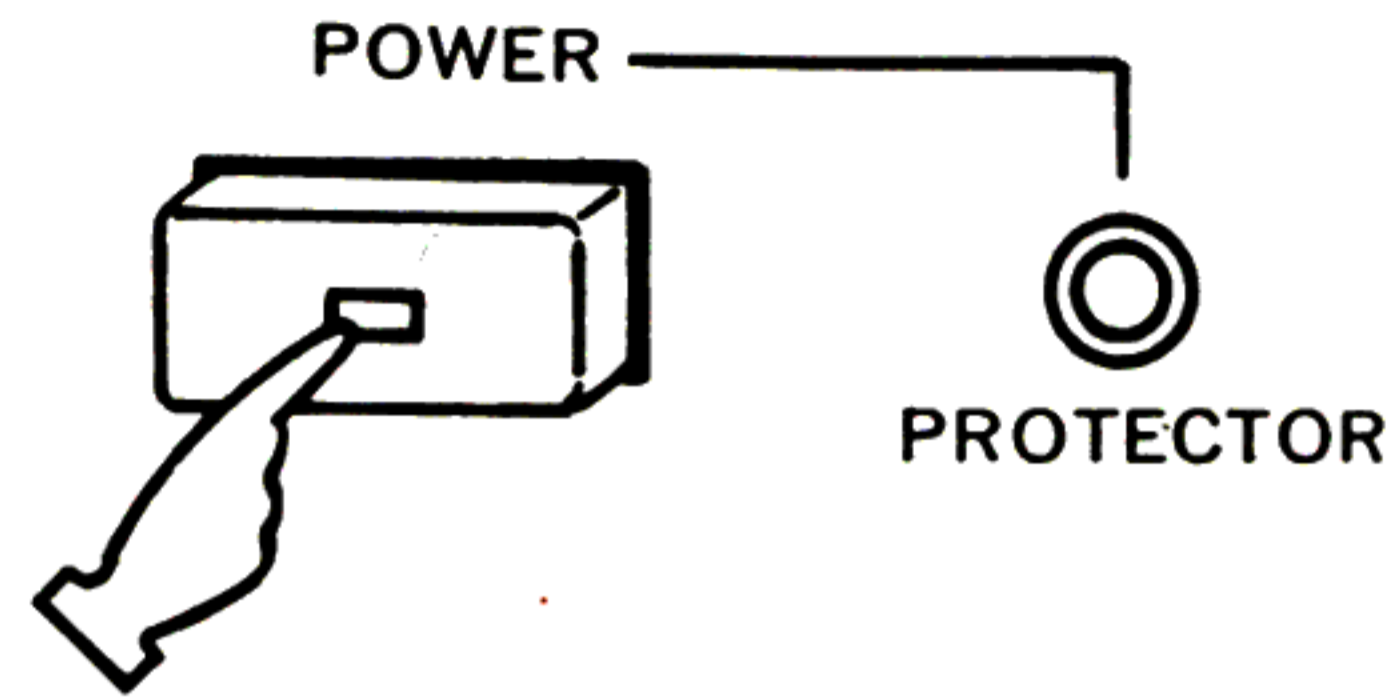

01 POWER Switch POWER/PROTECTOR Indicator

Push the POWER switch once to turn the unit on, once more to turn it off.

When the POWER switch is set to ON, the indicator glows red, and it turns green a few seconds later to indicate safe operation of the unit. When there is some malfunction somewhere in the unit's circuitry during operation, the indicator turns red. Should the indicator turn red during operation, turn the power off and check for possible cause.

02 SPEAKERS Switch

03 PHONES Jacks

The SPEAKERS switch selects the speaker system(s) you want to hear. When listening through a headset, insert its plug into the PHONES Jack.

OFF: To cut off the source from the speaker systems when listening with headphones.

A: To drive the speaker systems connected to the rear-panel SPEAKERS SYSTEM-A terminals.

B: To drive those connected to the SYSTEM-B terminals.

C: To drive the ones connected to the SYSTEM-C terminals.

A + B: To drive both A and B pairs of speaker systems.

A + C: To drive both A and C pairs of speaker systems.

- If the SPEAKERS switch is set to A + B or A + C, no sound will be heard unless speaker systems are connected to both sets of terminals.

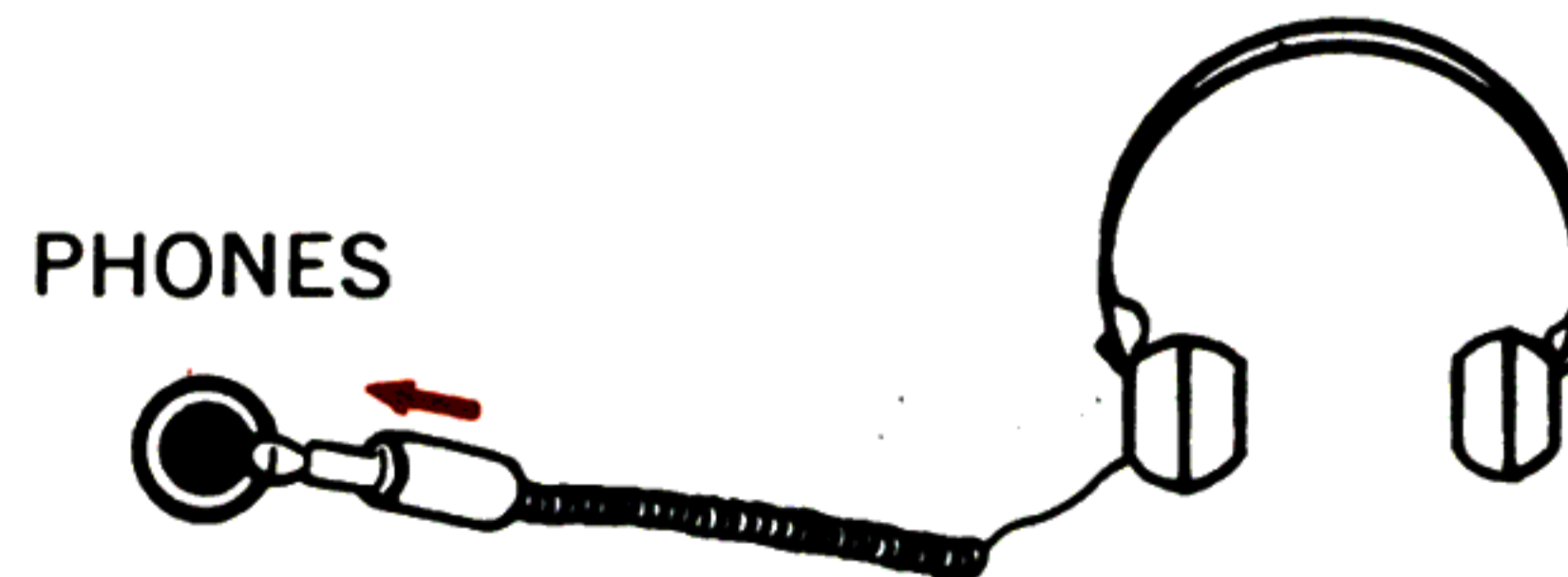
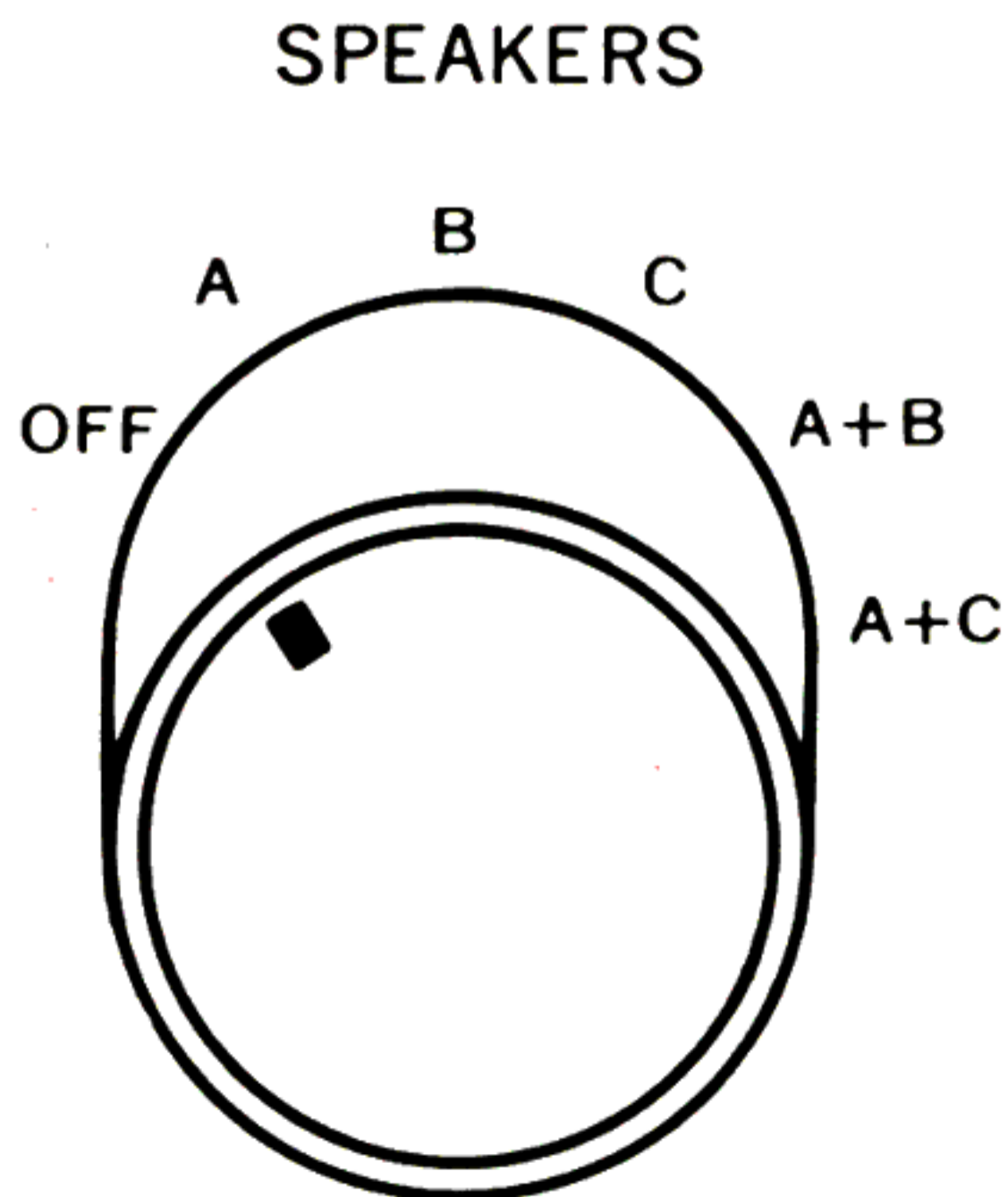

VOLUME  BALANCE

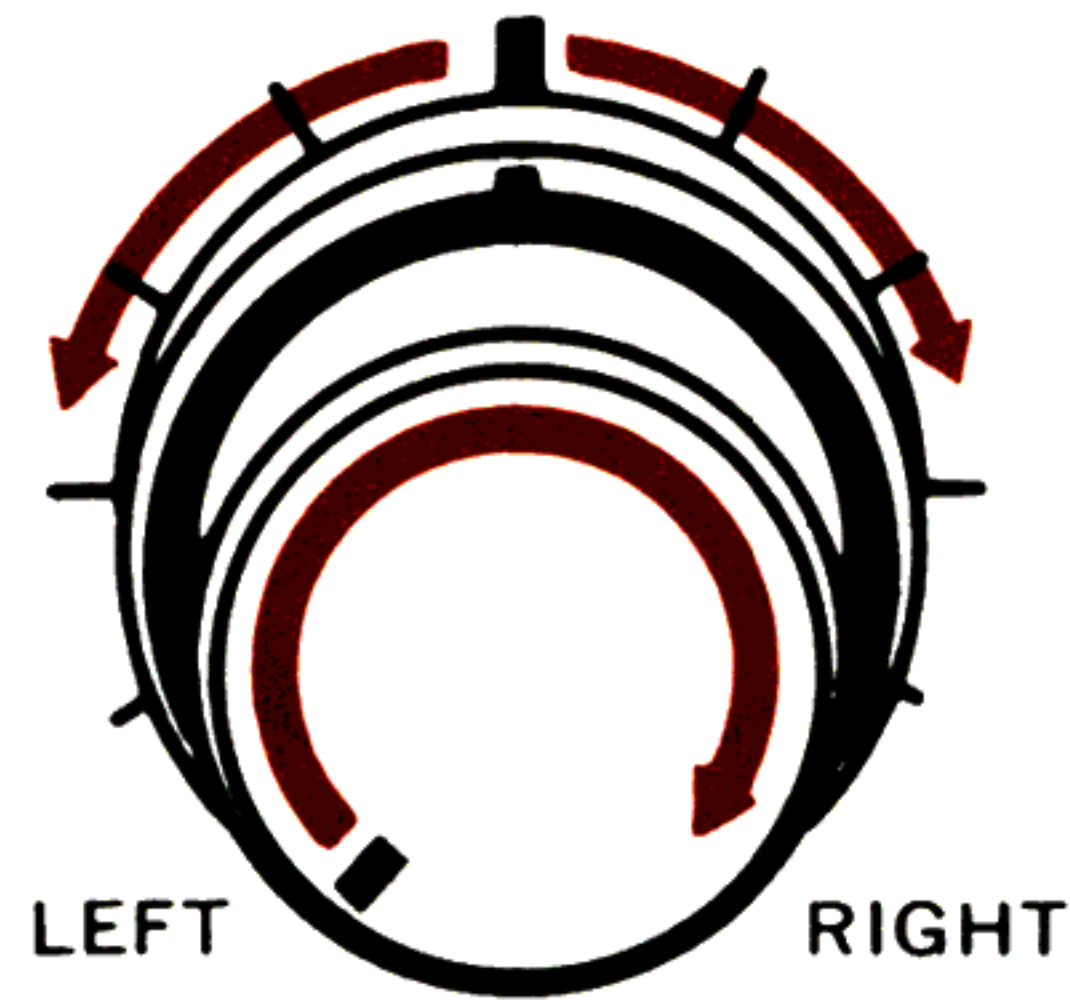

04 VOLUME Control

The overall volume is controlled by the VOLUME control. Adjust it while actually listening to music. The more it is turned to right, the louder the volume becomes.

05 BALANCE Control

The volume of the left and right speakers can be adjusted by the BALANCE control. As the control is turned counterclockwise from the center position, the sound from the left speaker becomes louder than that from the right speaker, and vice versa.

SELECTOR

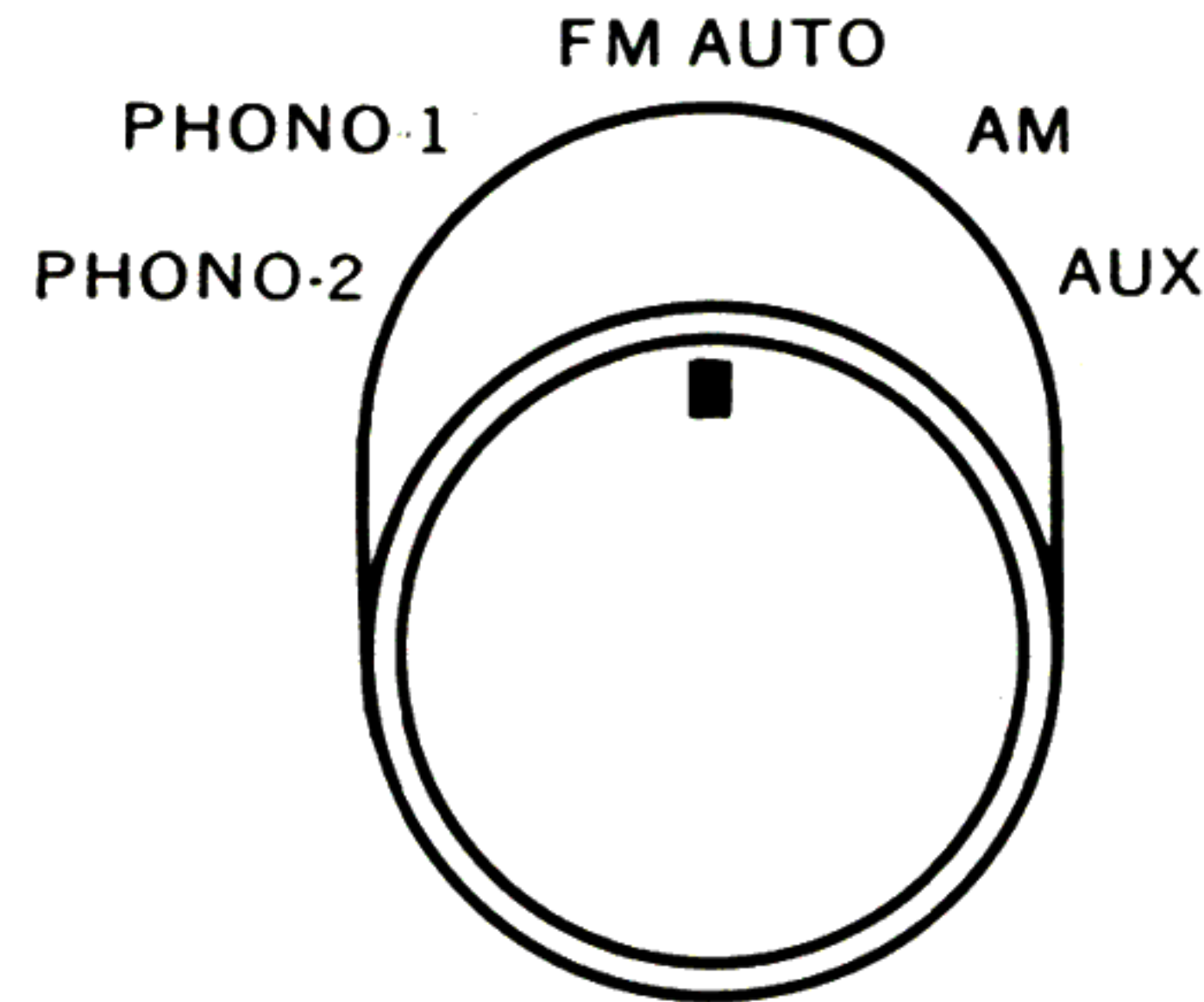

06 SELECTOR Switch

Use this switch when listening to records and broadcasts.

PHONO-1, 2: For playing disc records.

FM AUTO: For receiving FM stereo or mono broadcasts.

AM: For receiving AM broadcasts.

AUX: To reproduce whatever program source is connected to the rear-panel AUX inputs.

07 Tuning Control

08 SIGNAL Meter

09 TUNE Meter

The tuning control is used to tune a desired AM or FM station, as follows:

Tuning an AM station:

Your station is properly tuned when the SIGNAL meter needle registers maximum deflection to the right. The TUNE meter is for FM only.

Tuning an FM station:

Your station is properly tuned when the SIGNAL meter needle registers maximum deflection to the right and when the needle of the TUNE meter is accurately centered within the zone indicating maximum quality FM reception. The unit is tuned in on an FM station broadcasting in stereo automatically, and the FM STEREO indicator lights.

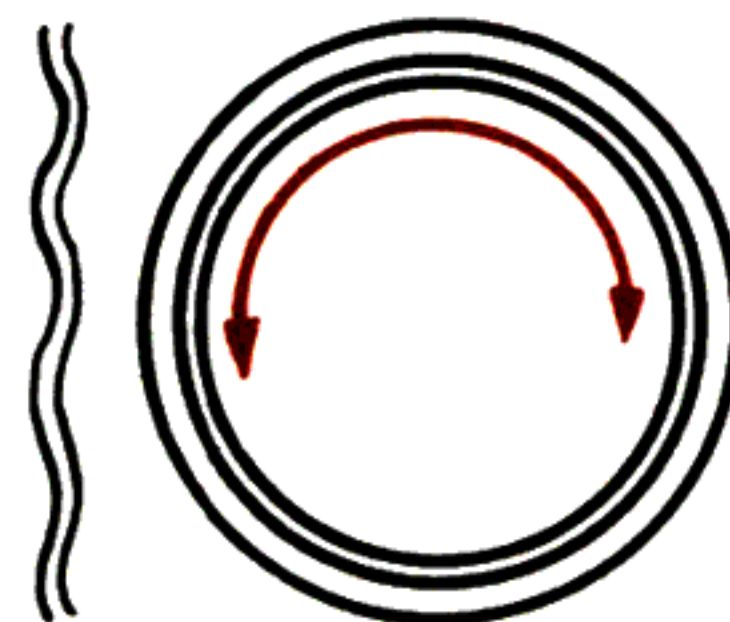
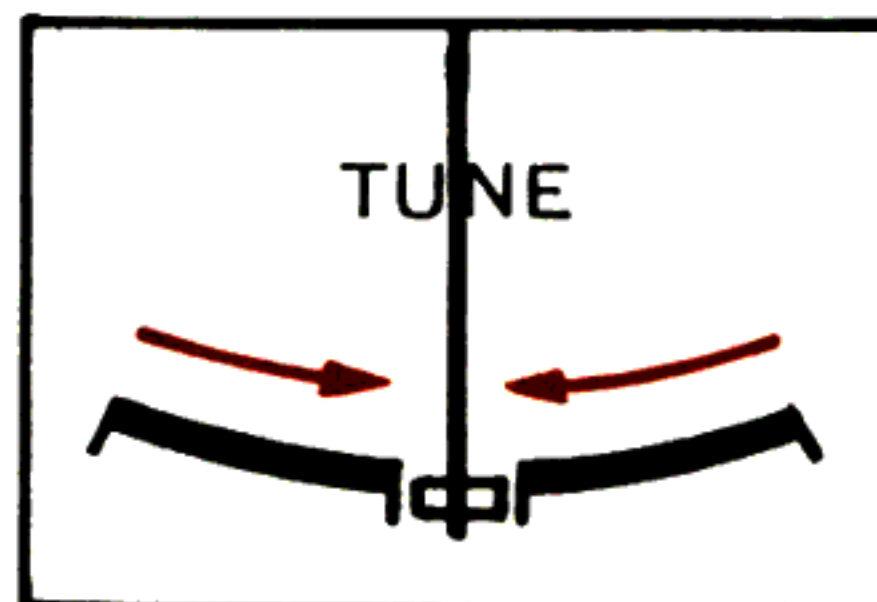
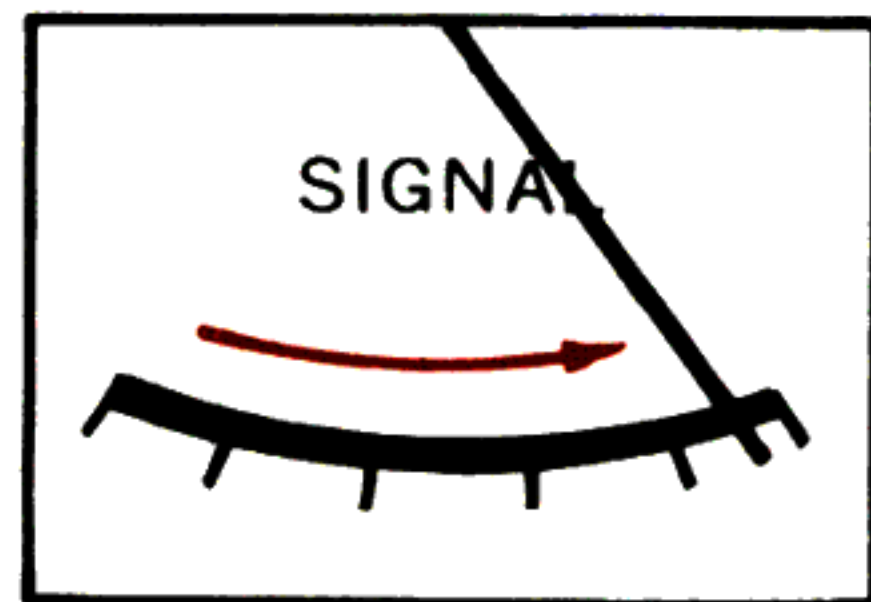

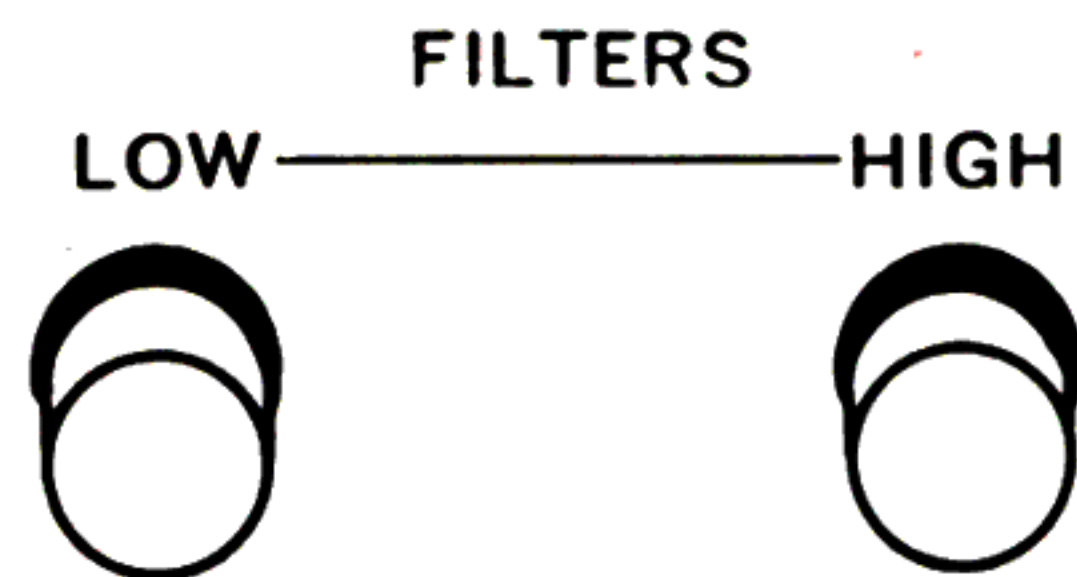

10 LOW FILTER Switch HIGH FILTER Switch

Use the LOW FILTER switch to eliminate low-frequency noise. Pushing it reduces disturbing low-frequency noise such as may be produced by a turntable motor.

If high-frequency noise disturbs you, push the HIGH FILTER switch. Surface noise from a worn record, fluorescent lamp noise and other kinds of high-frequency noise will be reduced.

11 AUDIO MUTING Switch

With this switch, you can reduce the volume by 20dB instantly. It is most convenient when you reduce the volume temporarily on such occasions as when you answer a phone call or place a stylus on the record surface. Adjustment of the volume of very low sounds is easily carried out by adjusting the VOLUME control after the AUDIO MUTING switch has been set to the depressed position.

LEFT

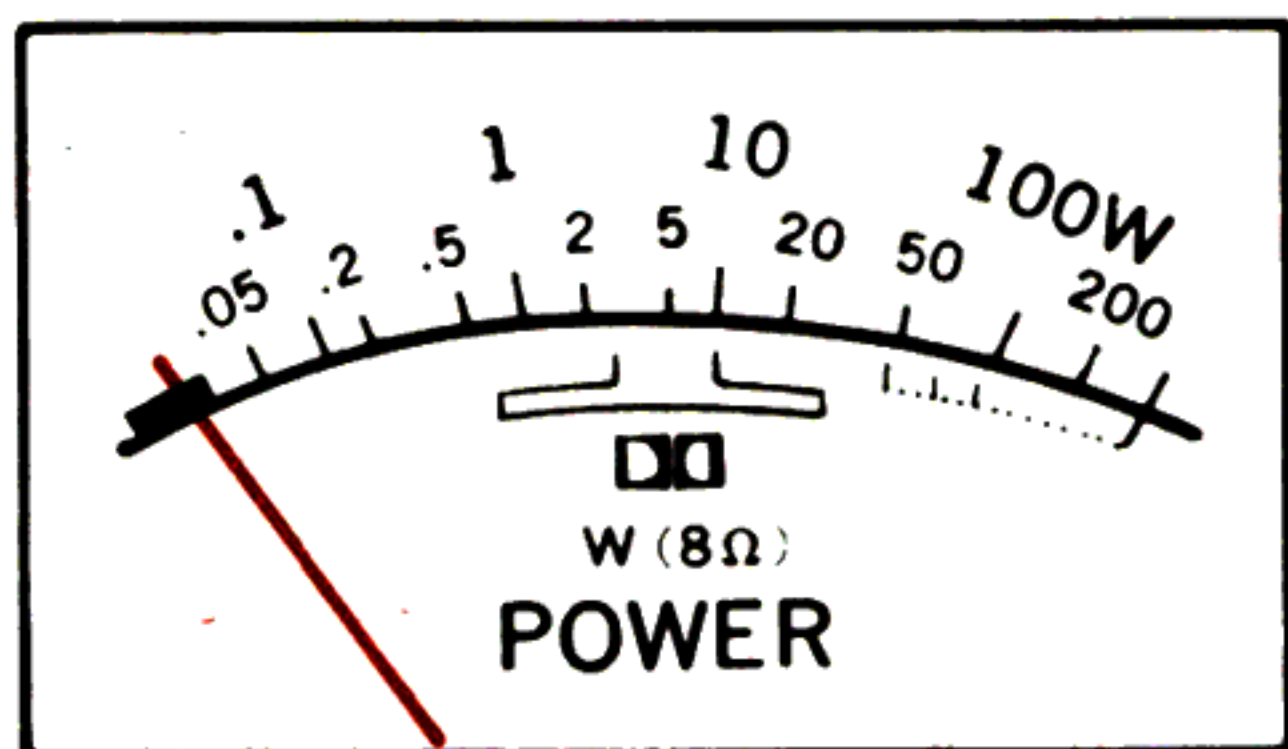

RIGHT

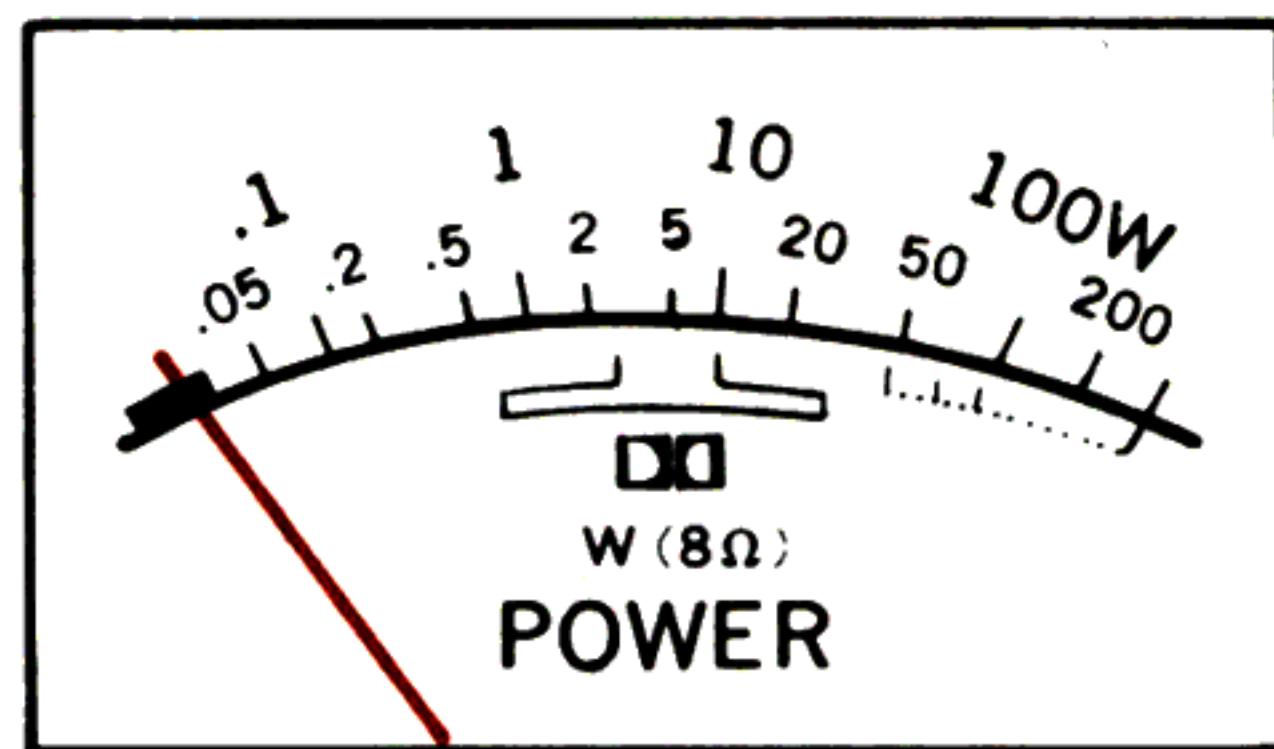

12 POWER Meters

These two meters directly read the RMS power output of each channel when the unit is driving speaker systems with 8-ohm impedance. When speakers with 4-ohm impedance are driven, however, you can obtain the correct RMS power output by doubling the indicated figure. With speakers with 16-ohm impedance connected, the correct power output is obtained by halving the indicated figure.

- With the METER switch pushed in (DOLBY NR LEVEL), you can use the POWER meters for Dolby level calibration.

13 LOUDNESS Switch

Pushing this switch when listening at a low volume level accents the lows and highs properly to render the reproduced sound more realistic. This compensates for the fact that the human ear becomes insensitive to the lows and highs as the sound volume is reduced.

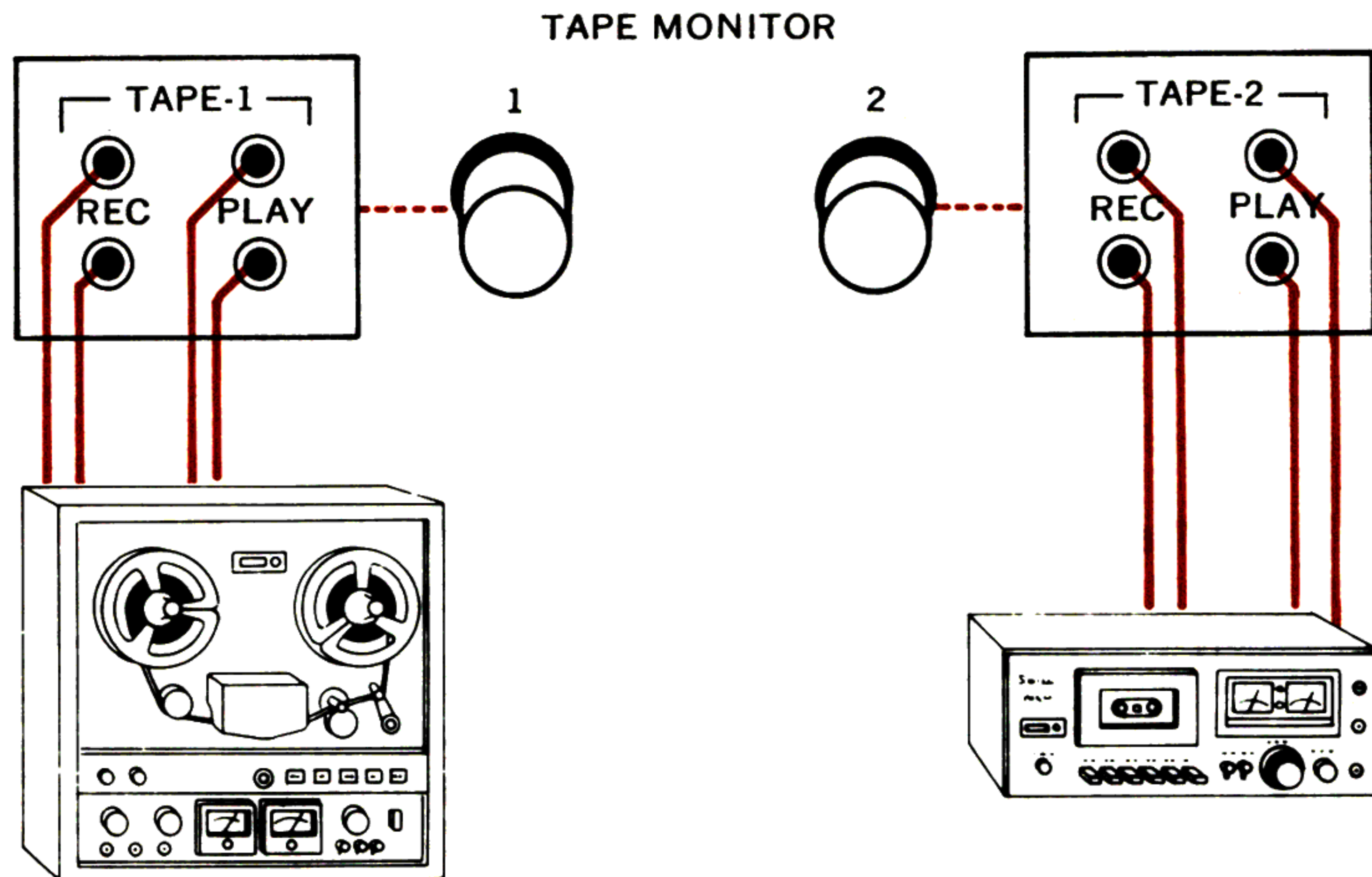

14 MONO Switch

Push this switch when you connect a monophonic record player or tape deck to either the left or right channel input terminal, or when you wish to mix the left and right channel signals. The left and right speaker systems will then deliver identical sounds. Keep it at the stereo (protruding) position at all other times.

15 FM MUTING OFF Switch

This FM MUTING OFF switch eliminates weak signals as well as irritating inter-station noise. Push it (turning the circuit off) to receive weak-signal stations.

16 TAPE MONITOR Switch

To play back a recorded tape or to monitor your recording as you record, push the TAPE MONITOR switch 1 or 2, whichever is applicable for the tape deck you wish to use. Monitoring of your recording while you record is only possible with 3-head tape decks having separate record and playback heads.

- When you finish playing back or monitoring, push the switch once more to release it.

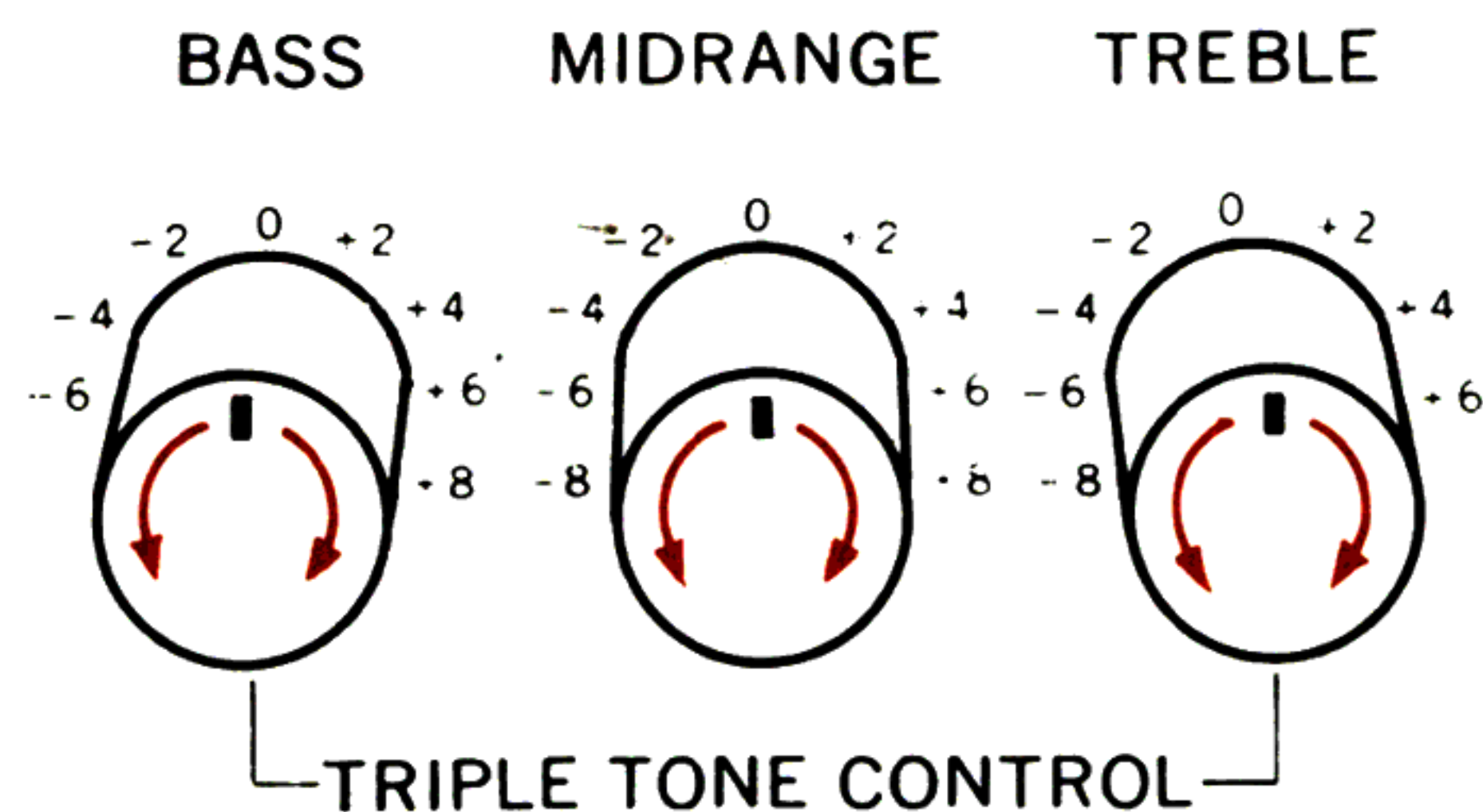

17 BASS Tone Control

Sounds of a bass and other low-frequency sounds can be emphasized or de-emphasized by adjusting the BASS tone control.

18 MIDRANGE Tone Control

Emphasize or de-emphasize vocal sounds and other middle-frequency sounds by adjusting the MIDRANGE tone control.

19 TREBLE Tone Control

Sounds of cymbals and other high-frequency sounds can be emphasized or de-emphasized by adjusting the TREBLE tone control.

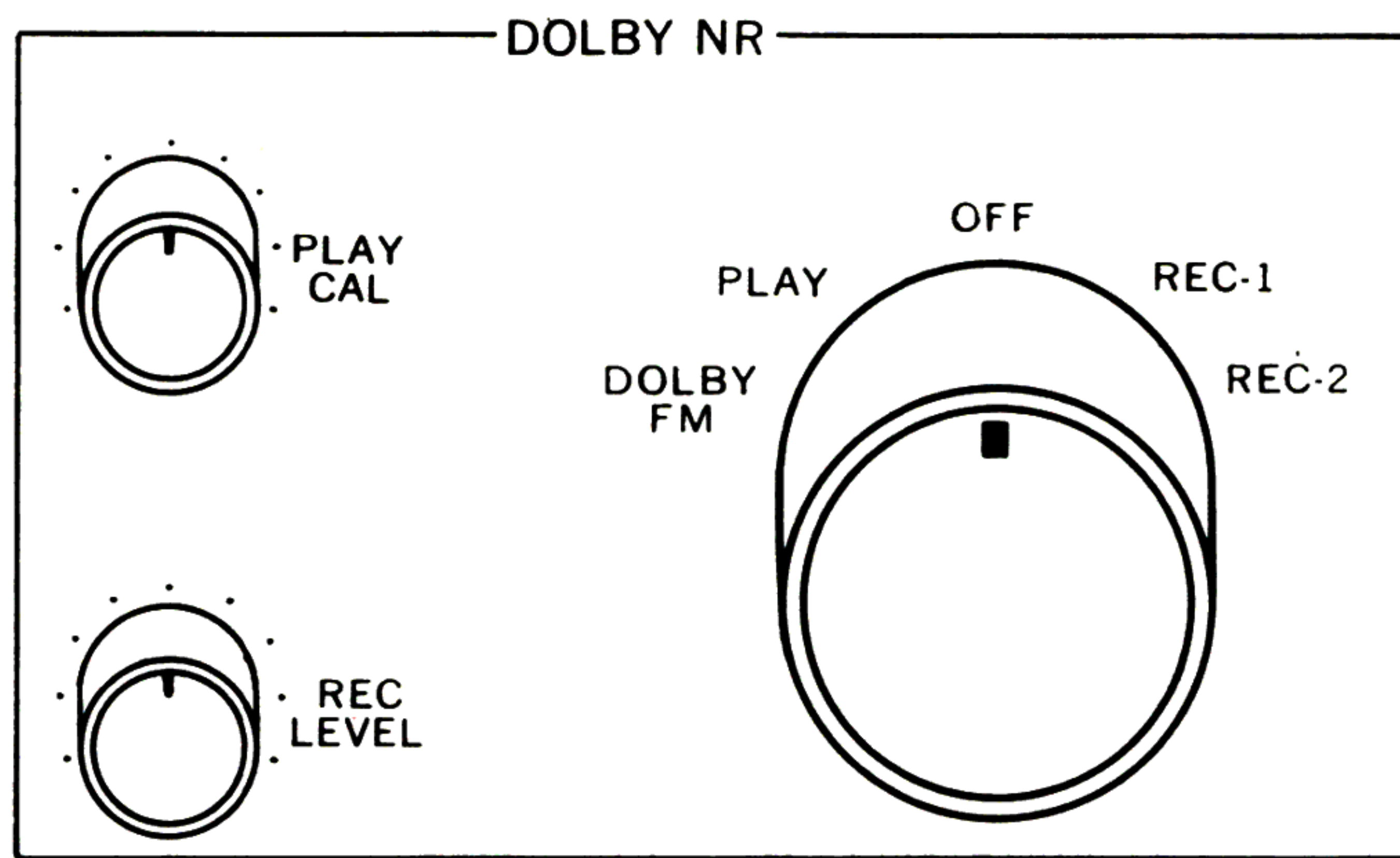

20 REC LEVEL Control

When recording through the Dolby Noise Reduction system, adjust recording level of a connected tape deck; use this control for record level settings instead of the recording level controls on your tape deck.

21 PLAY CAL Control

Adjust to calibrate for Dolby level when playing back a Dolbyized tape.

22 DOLBY NR Switch

Set this switch to suit your purpose of using the built-in Dolby Noise Reduction system:

- DOLBY FM:** To receive a Dolbyized FM broadcast.
- PLAY:** To play back a Dolbyized recorded tape.
- OFF:** When you are not using the Dolby Noise Reduction system.
- REC-1, 2:** To record through the Dolby Noise Reduction system. If you are going to record into the tape deck connected to TAPE-1 terminals, set the switch to REC-1. Set it to REC-2 if recording into the one connected to the TAPE-2 terminals.

- Whenever you are not using the Dolby Noise Reduction system, be sure to keep the switch at OFF.

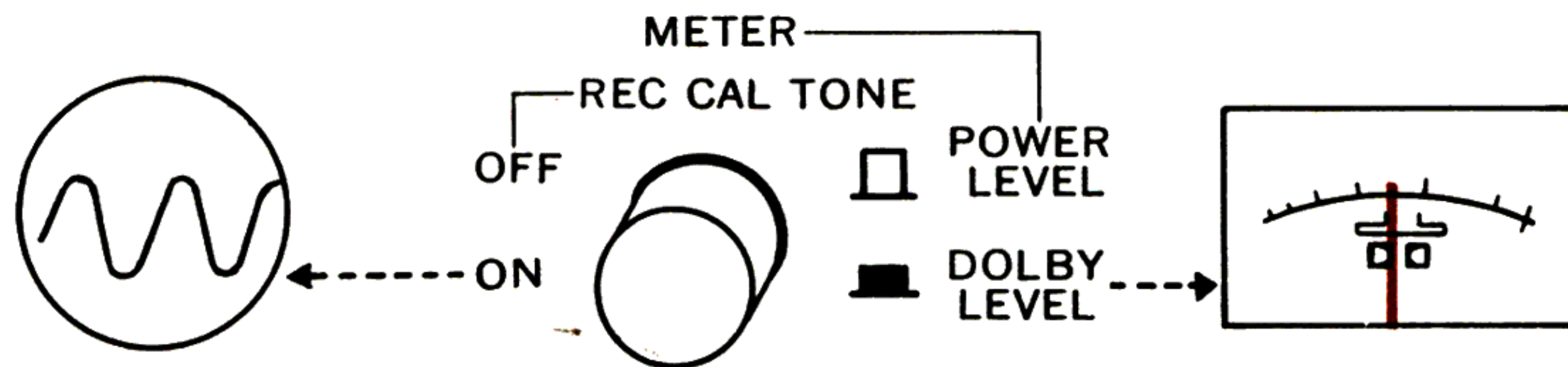

23 METER/REC CAL TONE Switch

Push when making Dolby calibration tape or when checking the DC level with the built-in meters. Push it again to let the meters read power output directly.

MIC LEVEL

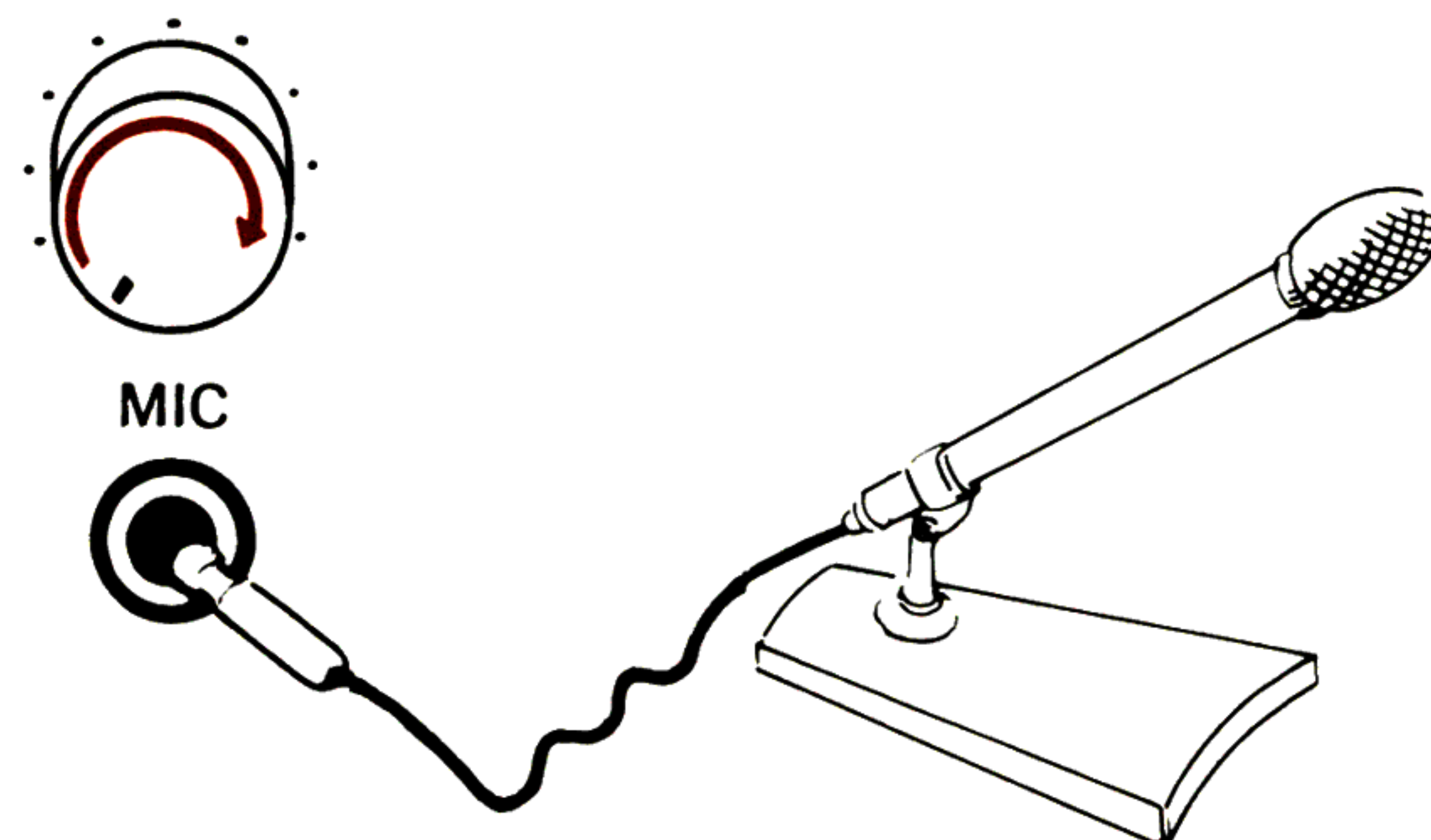

24 MIC LEVEL Control

Insert a microphone plug into the front-panel MIC jack and adjust level with the MIC LEVEL control. You can mix microphone sound with other program sources. (Refer to page 30 and 31).

ABOUT DOLBY NR

Recording/playback by the Dolby system Enregistrement/reproduction par le système Dolby Aufnahme und Wiedergabe mit dem Dolby-System

RECORDING
ENREGISTREMENT
AUFNAHME

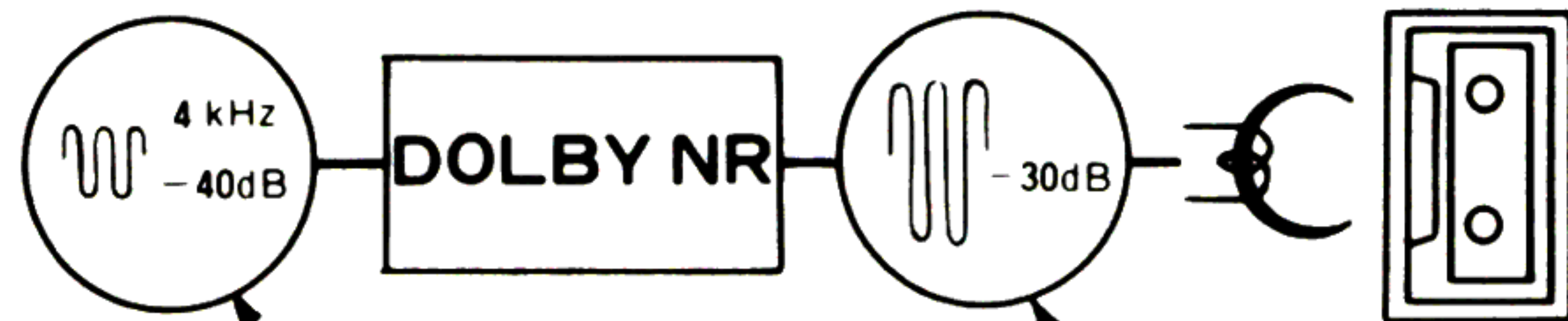

PLAYBACK
REPRODUCTION
WIEDERGABE

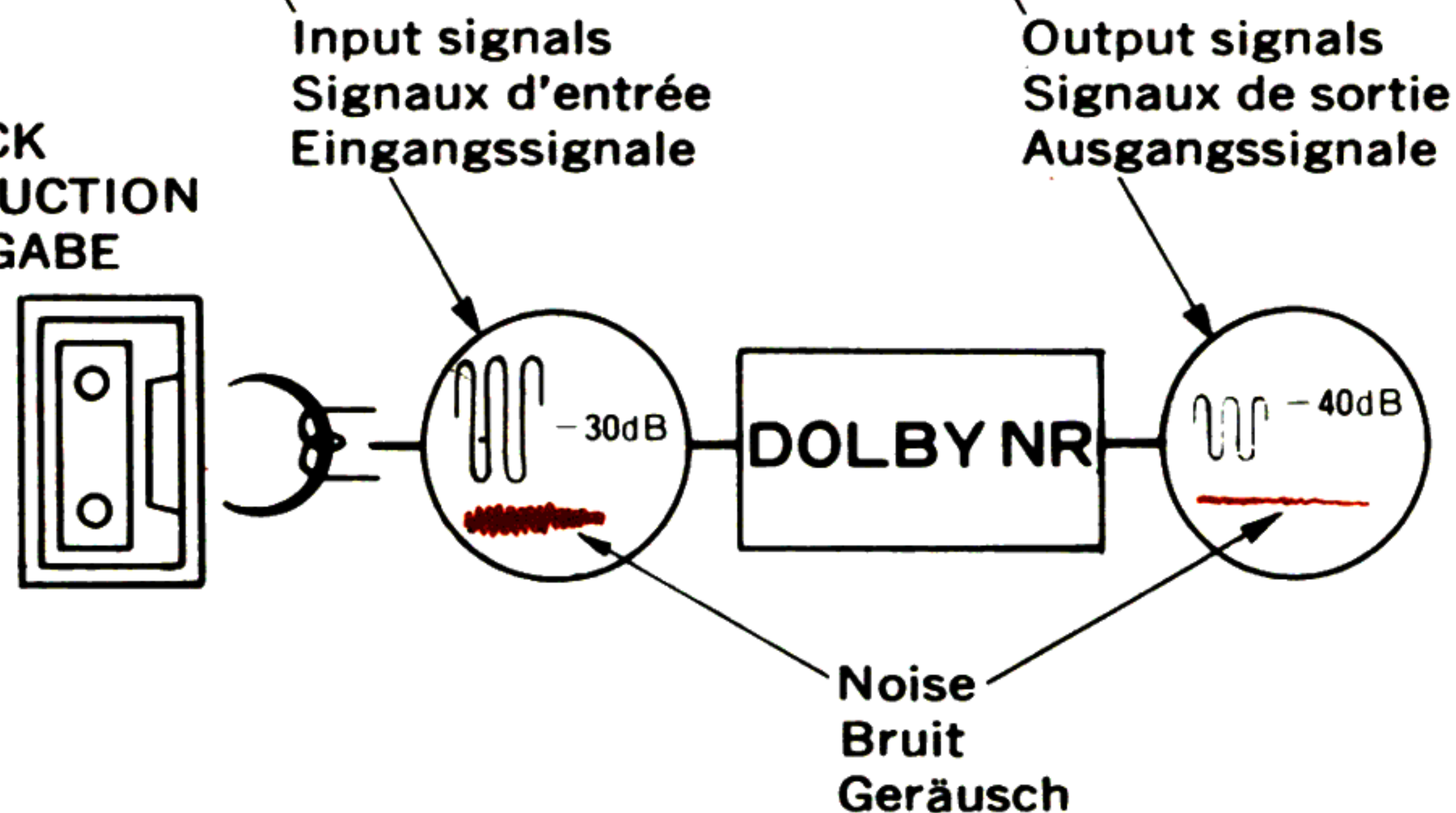

In Dolby Noise Reduction system, high and midrange frequencies below a certain level are boosted during recording in inverse proportion to their levels. In playback, they are attenuated in complete proportion. Thus when a recording is made and played back through the Dolby Noise Reduction system, mid-to-high frequency noises such as tape hiss are effectively eliminated. With the Dolbyized FM broadcast signal is Dolby-encoded at the station; by decoding it through a Dolby circuit at the receiver's side, you will enjoy clean, less noisy reception.

Dolby level calibration

Dolby* level calibration ought to be carried out using a calibration tape before recording and playing back through the built-in Dolby Noise Reduction** system. You can make calibration adjustments using a calibration tape (see below) provided that you make a recording on that tape deck and play it back on that tape deck. However, to achieve universal compatibility with the Dolby circuits in a different tape deck or systems is possible only when you have a standard calibration tape. For details, write to Sansui Electric Co., Ltd., Sansui Electric Corporation (U.S.A.) or Sansui Audio Europe N.V.

- Whenever you use different types of tape or speeds from the one on which calibration is made, be sure to undertake re-calibration.

* The word "Dolby" and the Double-D symbol are a trademark of Dolby Laboratories Inc.

** Noise reduction circuit made under license from Dolby Laboratories Inc.

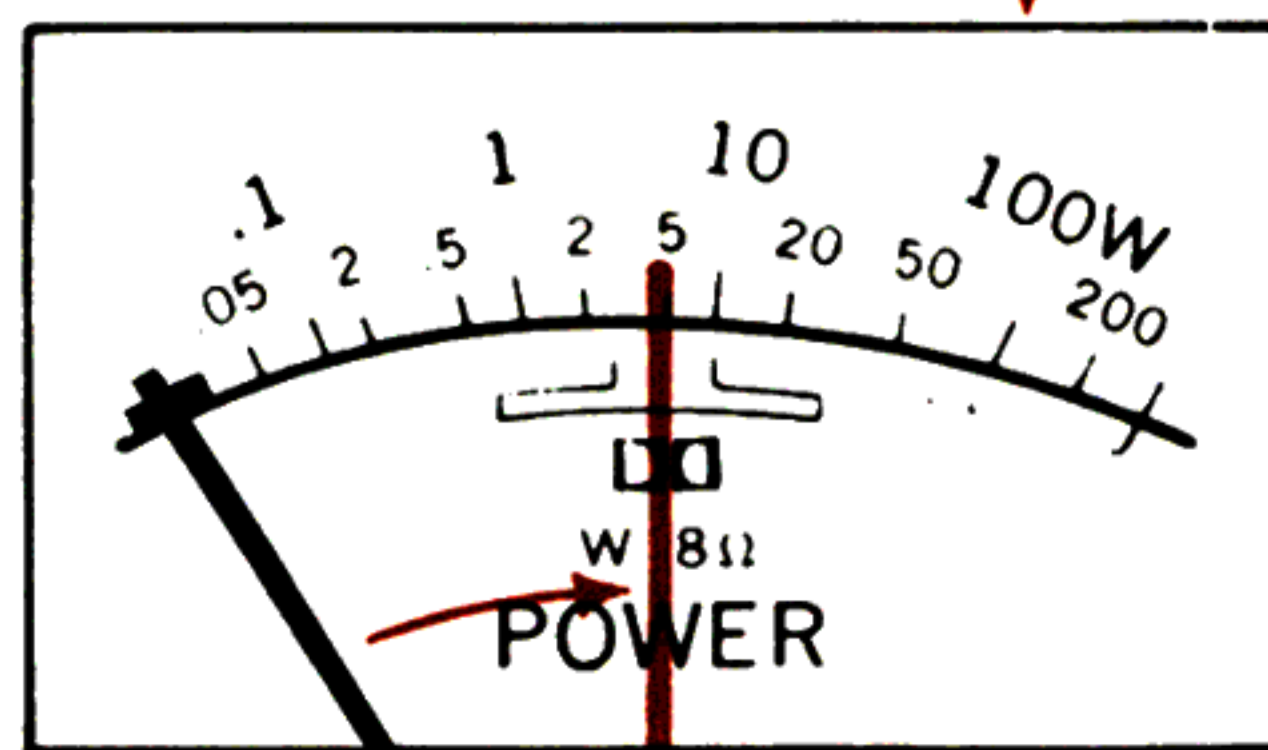
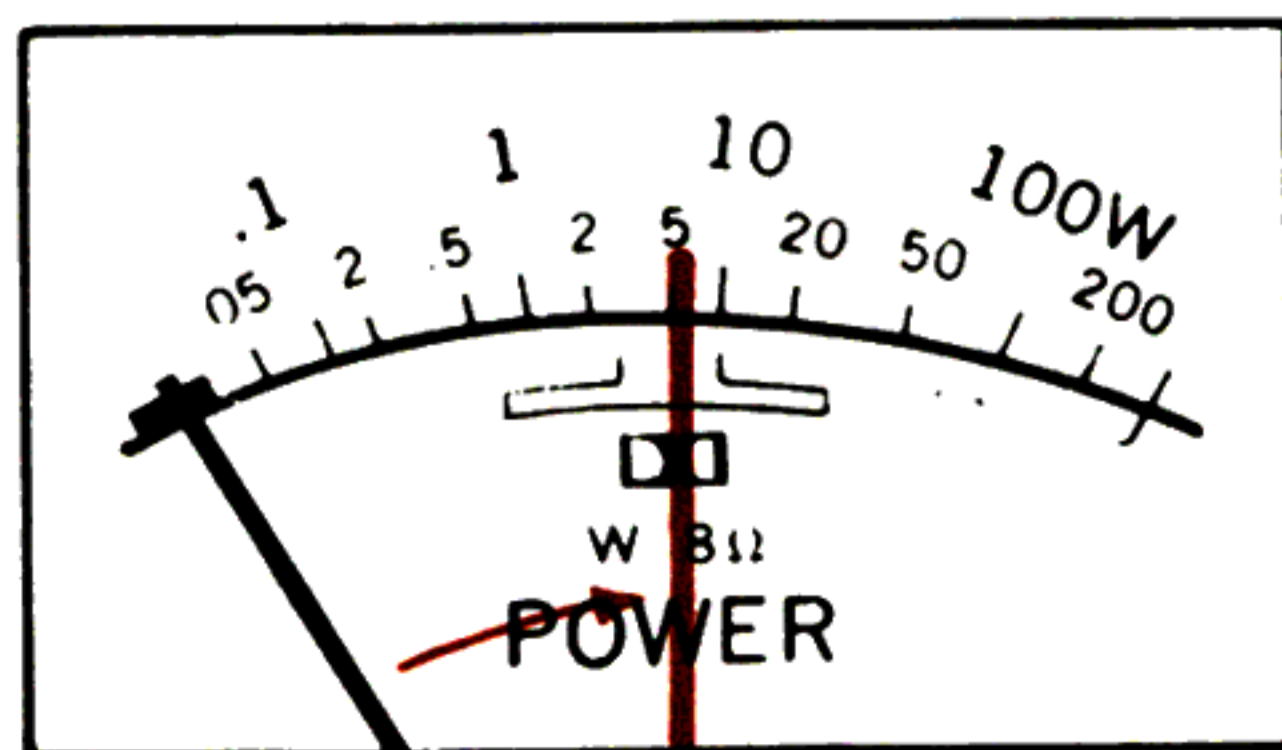
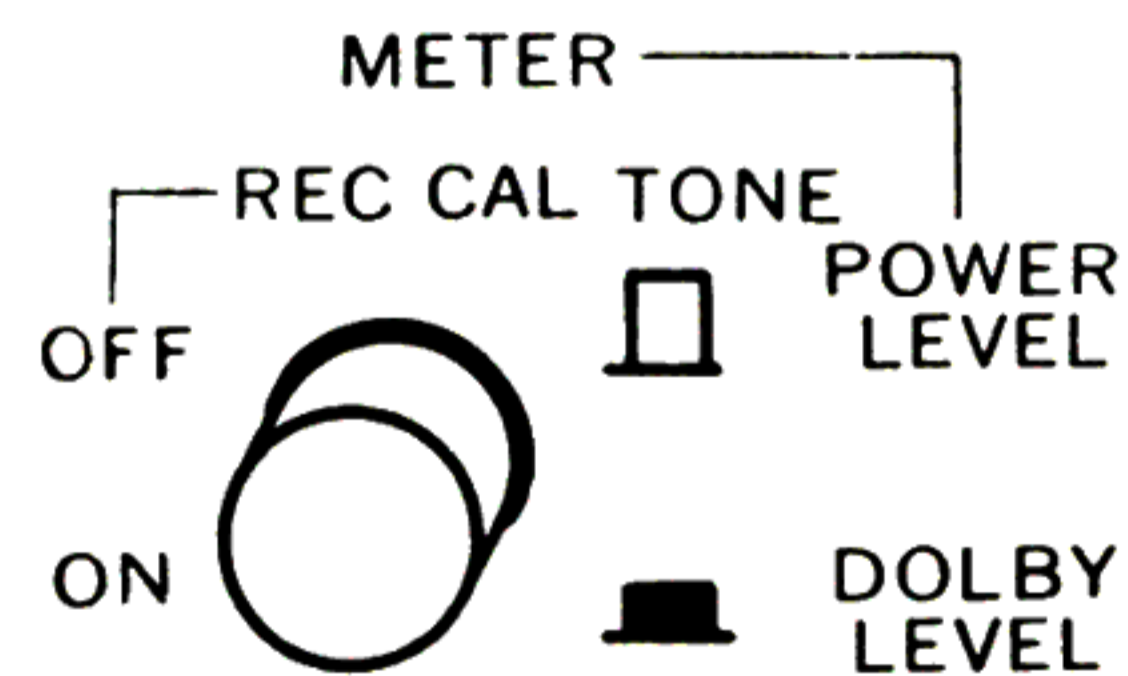
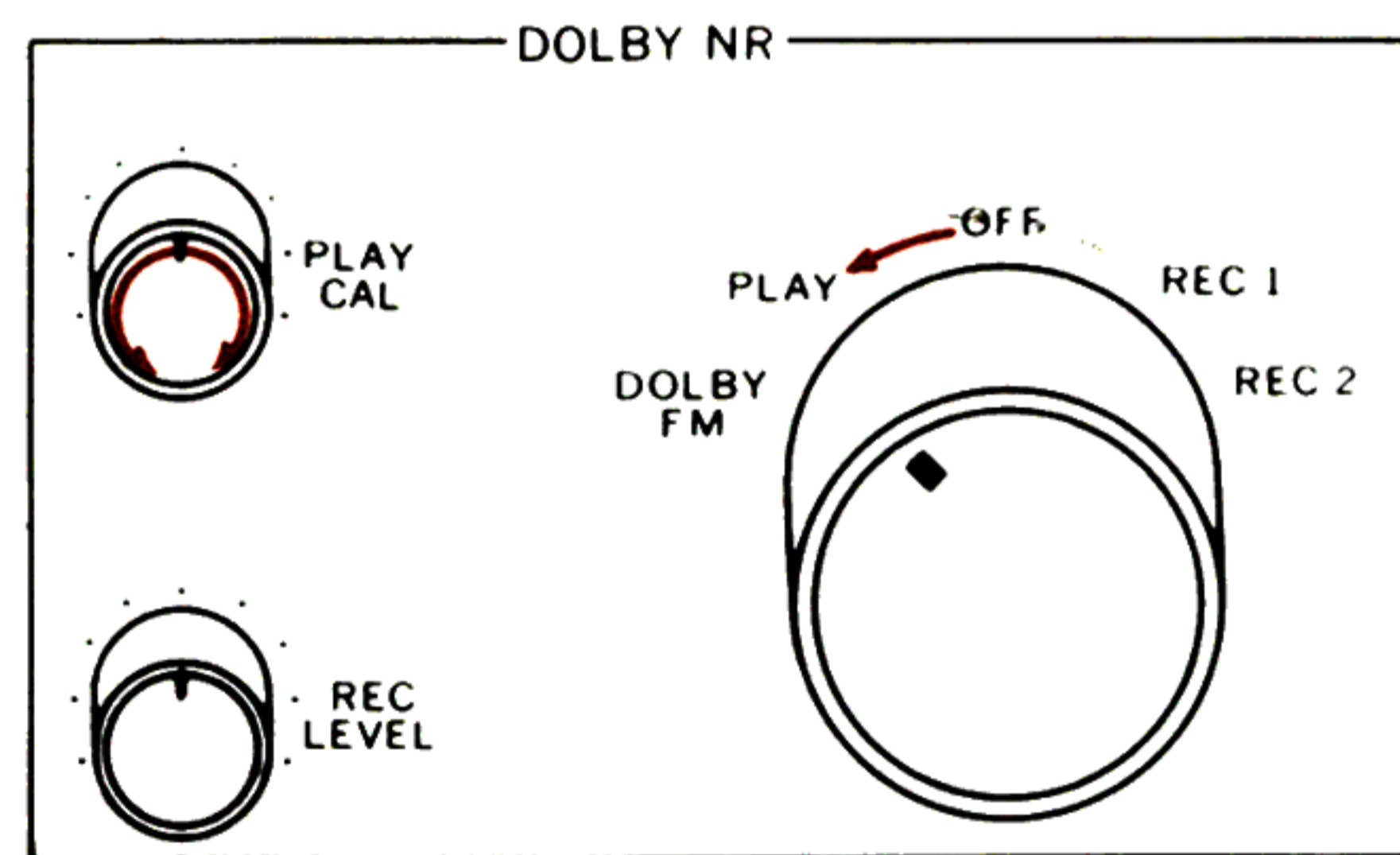
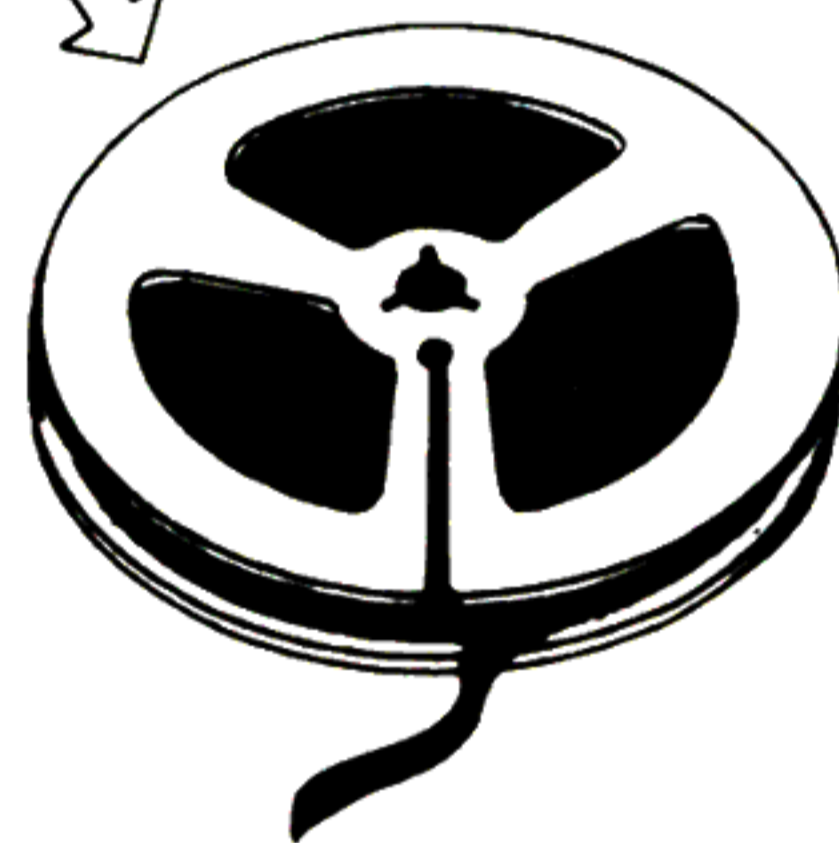
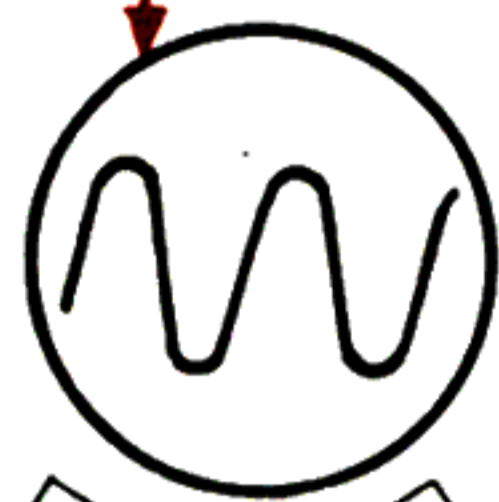
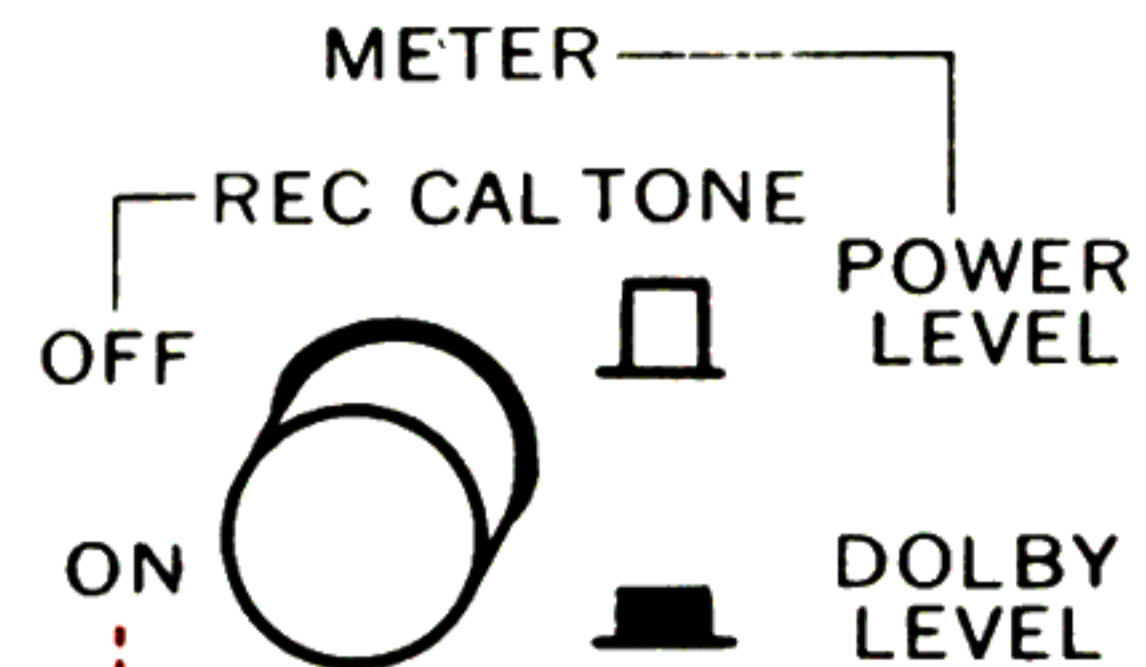
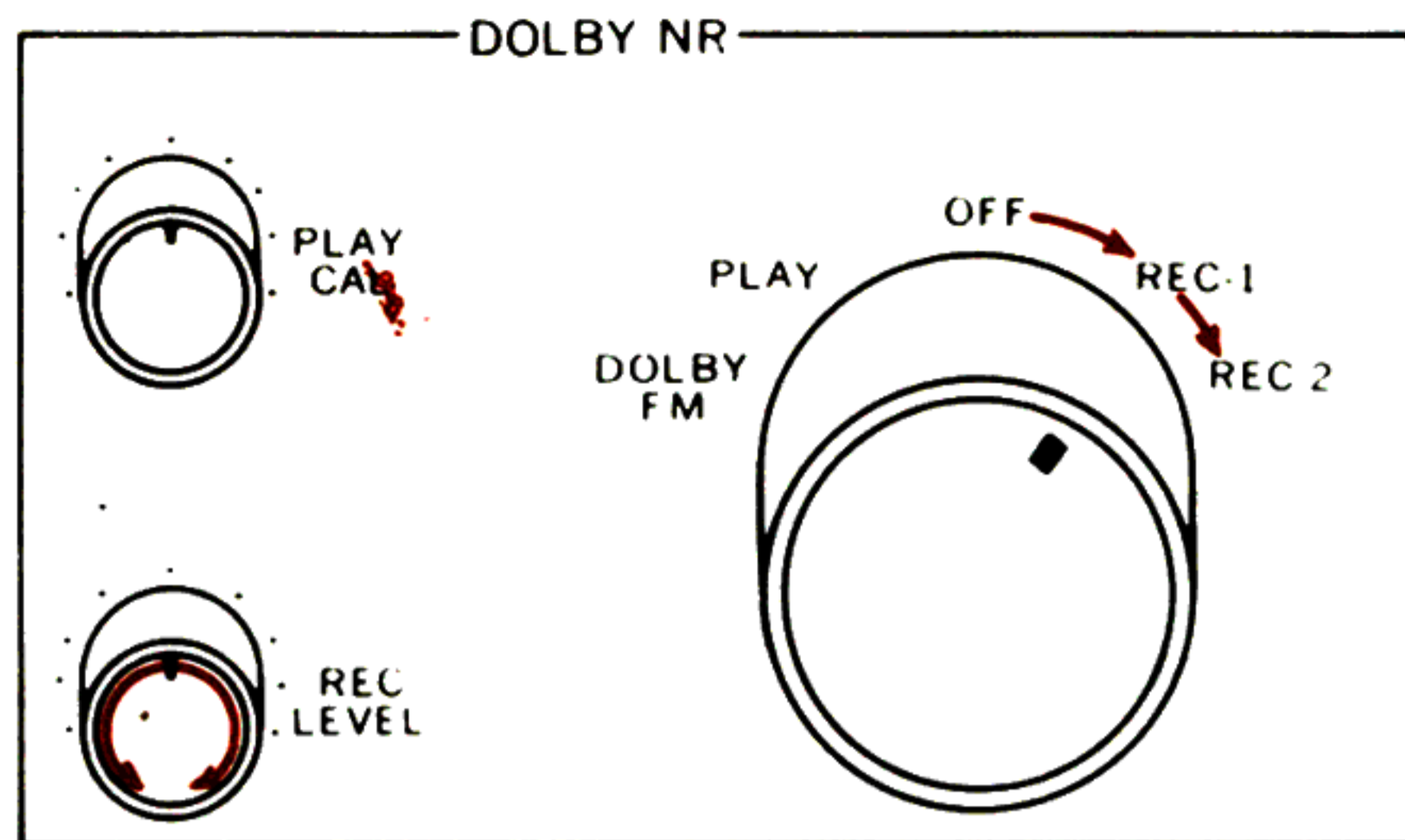

Calibrating Dolby levels before recording

1. Load a cassette tape (or a reel of tape) on your tape deck.
2. Set the DOLBY NR switch to REC-1 or -2, whichever is applicable for the tape deck you wish to use.
3. Push the REC CAL TONE switch in (ON).
4. Adjust the record level controls on your tape deck so that the VU meter pointers will deflect up to "0" VU. Then record the test signal for five minutes, and use the tape as a Dolby calibration tape later.
5. Push the REC CAL TONE switch again (OFF).
 - Mark the position of the record level controls of your tape deck which the test signal was recorded. This becomes the "Dolby level calibrated point."

Adjusting DOLBY PLAY CAL Control

1. Load the Dolby calibration tape (prepared as instructed on the above) on your tape deck.
2. Push the TAPE MONITOR-1 or -2 switch, whichever is applicable for the tape deck you wish to use.
3. Set the DOLBY NR switch to PLAY.
4. Push the METER switch to set it at DOLBY NR LEVEL.
5. Engage your tape deck in the playback mode, and if your tape deck has playback level controls coupled to VU meters, then adjust the controls so that the meters will swing up to "0" VU. If the playback level controls on your tape deck are not coupled to its VU meters then simply turn them up to a point about two-thirds of the way toward maximum. If your tape deck has no playback level control proceed to step 6.
6. Play back the Dolby calibration tape, and adjust the PLAY CAL control so that the pointers of the VU meters on this unit will swing up to, but not beyond, the $\square\square$ mark.
7. Push the METER switch once more to restore it to POWER LEVEL.
 - When you finish step 5, mark the position of the playback level controls. Also, do not change the setting of the PLAY CAL control of this unit after it's adjusted.

OPERATING PROCEDURES

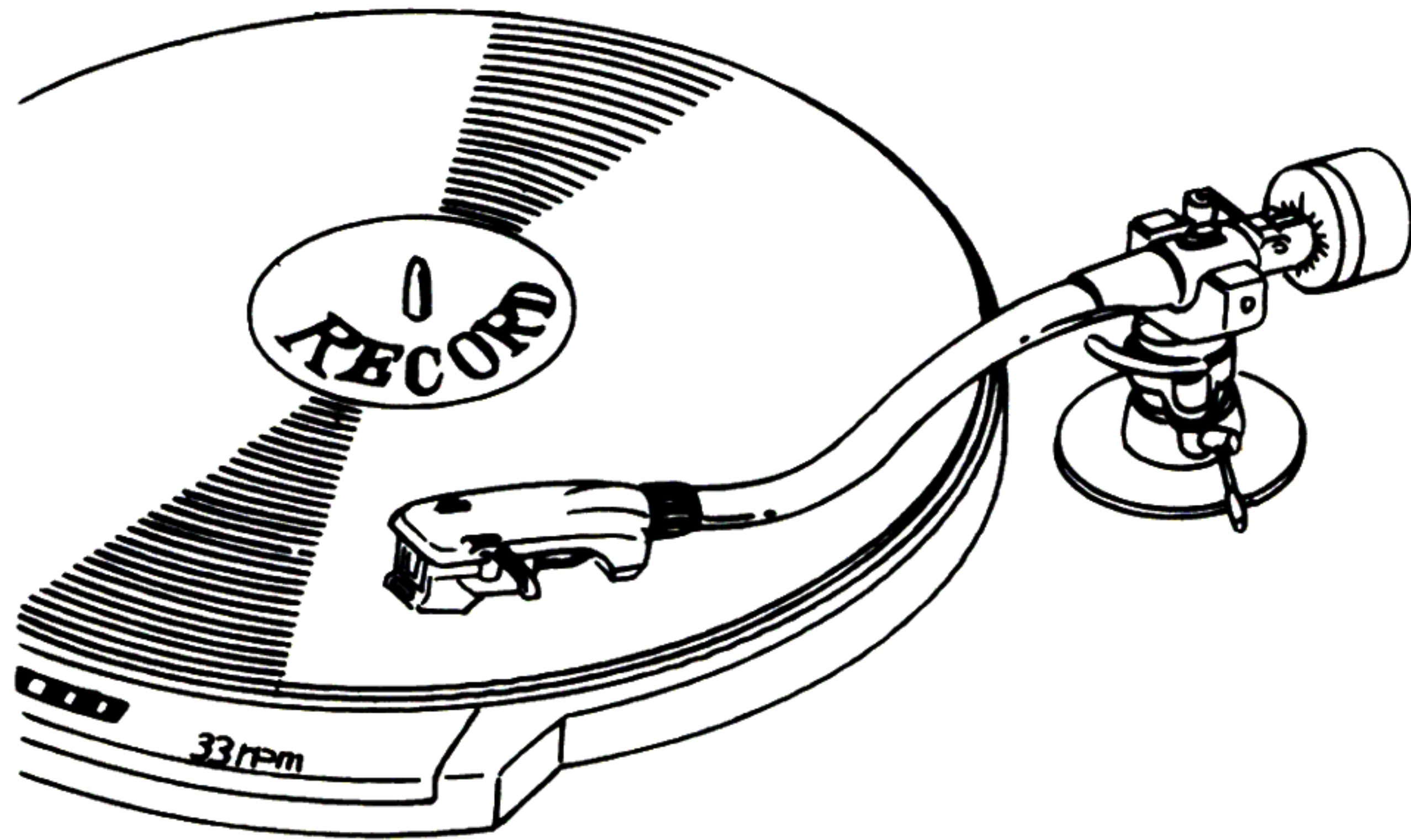

Listening to records

1. Confirm that the VOLUME control is not turned too far to right; it should be at a position where you can obtain the normal listening level.
2. Turn the SELECTOR switch to PHONO-1 or -2, whichever applicable for the turntable you wish to use.
3. Operate your turntable to play the records.
4. Adjust the unit's other controls and switches to suit the type music you are going to hear.

Poor-quality record reproduction

- * When you hear hum continuously, check the grounding of your turntable.
- * You may hear howling or acoustic feedback, caused when the pickup of your turntable is affected by the vibrating sound waves from the speakers, and undesired signals are amplified. To avoid howling, move the turntable away from the speakers or install the turntable on a solid, non-resonating stand. It can also be reduced when the turntable is placed at one of the corners of your room.
- * When you hear unstable, "shallow" reproduction during record playback, it is suggested that you check if there is dust accumulated on the surface of the record and on stylus tip. The cause may be a worn stylus tip. When you use a record cleaner, be sure to always use one of high quality.

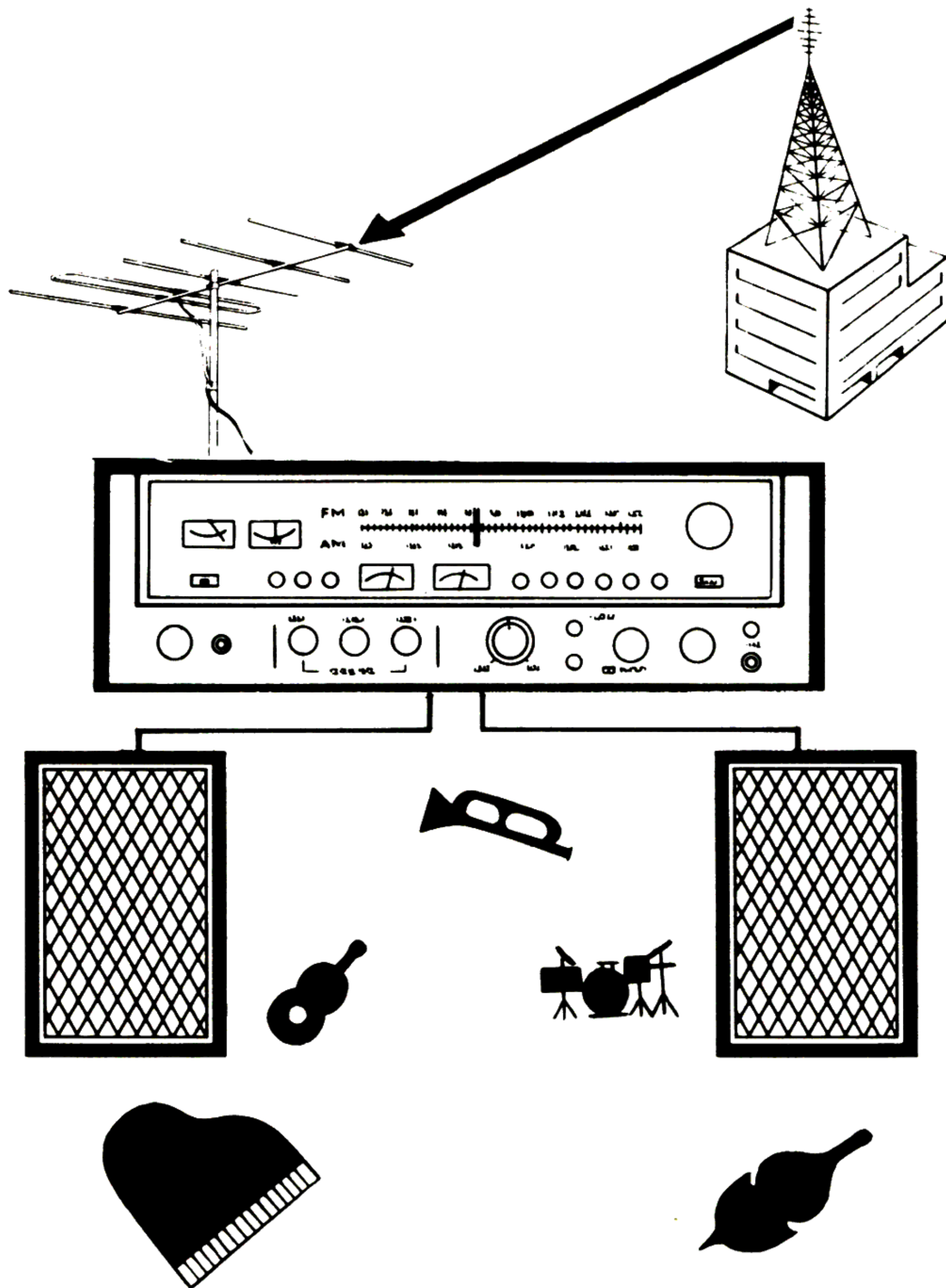

Listening to radio broadcasts

1. Confirm that the VOLUME control is not turned too far to the right; it should be at a position where you can obtain the normal listening level.
2. Set the SELECTOR switch to AM or FM AUTO, depending on the band you are about to hear.
3. Adjust the Tuning control and tune in the desired station.

Tuning an AM station:

Your station is properly tuned when the SIGNAL meter needle registers maximum deflection to the right. The TUNE meter is for FM only.

Tuning an FM station:

Your station is properly tuned when the SIGNAL meter needle registers maximum deflection to the right and when the needle of the TUNE meter is accurately centered within the zone indicating maximum quality FM reception.

To tune in a weak-strength or fringe-area FM station, first push the MUTING OFF switch.

- Only when receiving a Dolbyized FM broadcast, turn the DOLBY NR switch to DOLBY FM; at all other times, keep it at the OFF position.
4. Adjust the unit's other controls and switches to suit the type of music you are going to hear.

Noise during radio reception

- * Weak FM signals are often disturbed by ignition noise from nearby automobiles and other noise. Therefore, for better FM reception, installation of an outdoor FM antenna is suggested. For antenna connection, be sure to use a coaxial cable, not a feeder-type cable.
- * When you hear noise during AM reception, there are innumerable conceivable causes, which makes it almost impossible to eliminate all AM noises. Use the unit's filters when grounding the unit or mounting a noise-eliminating device fails to reduce such noise.

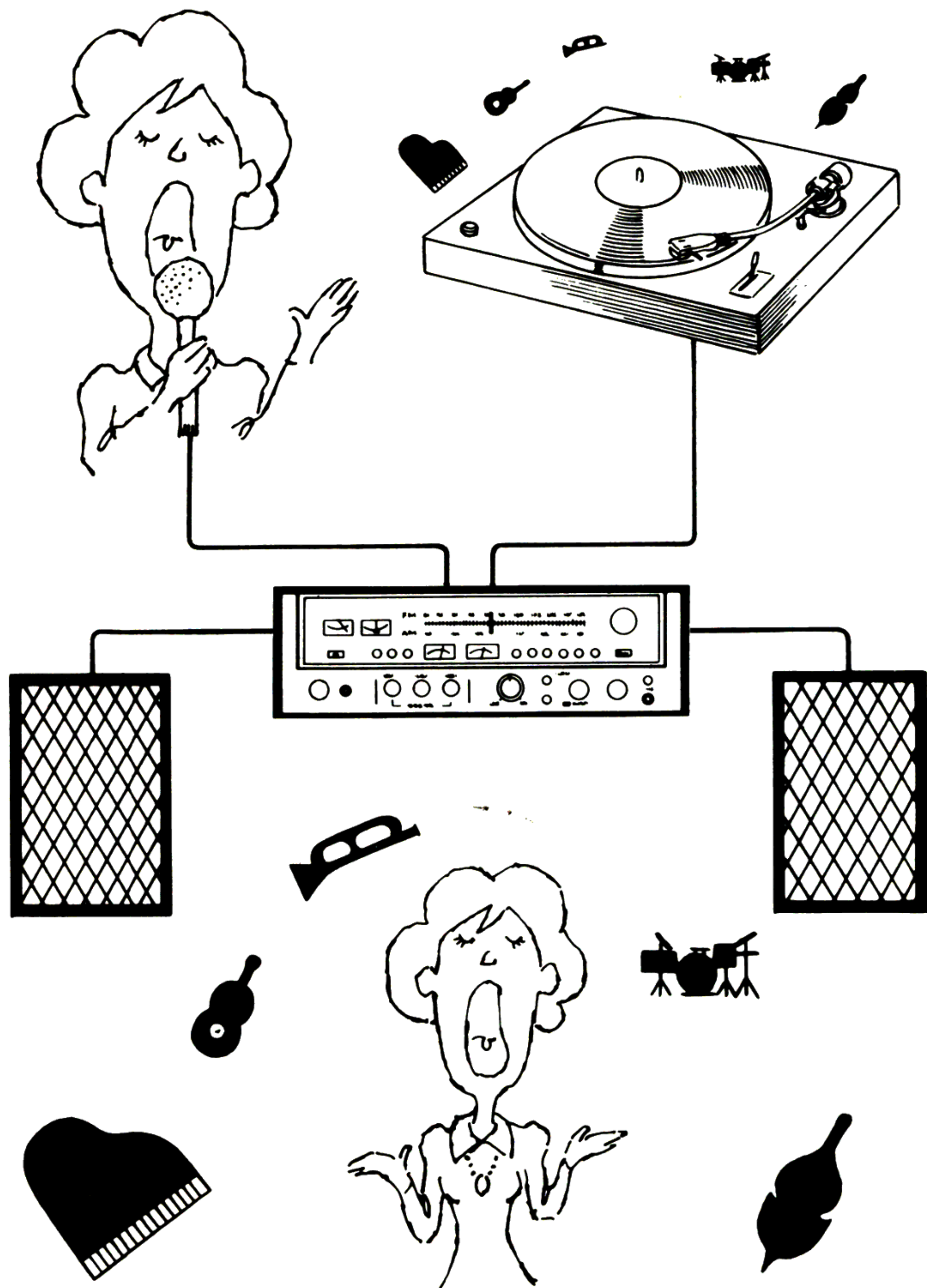

Using a microphone

1. Insert the microphone plug into the MIC jack on the front panel.
 2. Adjust the level of microphone sounds with the MIC LEVEL control.
 3. When mixing mic signals with other program sources (records, broadcasts or tapes), turn the SELECTOR control to the source you want to mix with and then turn the VOLUME control to adjust the level of the program source to match with the level of mic signals. When using the microphone only with no mixing, turn the VOLUME control fully counterclockwise.
- When inserting or removing the microphone plug, turn the MIC LEVEL control fully counterclockwise first.

About microphones

It is recommended to use a high-impedance ($10K\Omega\sim 50K\Omega$) microphone, although a low-impedance one (600Ω) will be more effective if you wish to use it several meters away from the unit. If using a low-impedance one with a small output (such as a dynamic type low-impedance microphone), you'll need a matching transformer between the microphone cord and the unit's MIC jack.

Howling while using a microphone

Loud oscillating noise may be heard from your speaker systems when using a microphone. This is a phenomenon called howling, and happens because the sound from your speakers is fed back to the microphone and amplified again, repeating the process infinitely. It is more likely to take place in an acoustically reflective room especially if you raise the sound volume.

It can be avoided either by directing or moving the microphone away from the speaker systems. Also, it may stop if you manipulate the high and/or low filter switches.

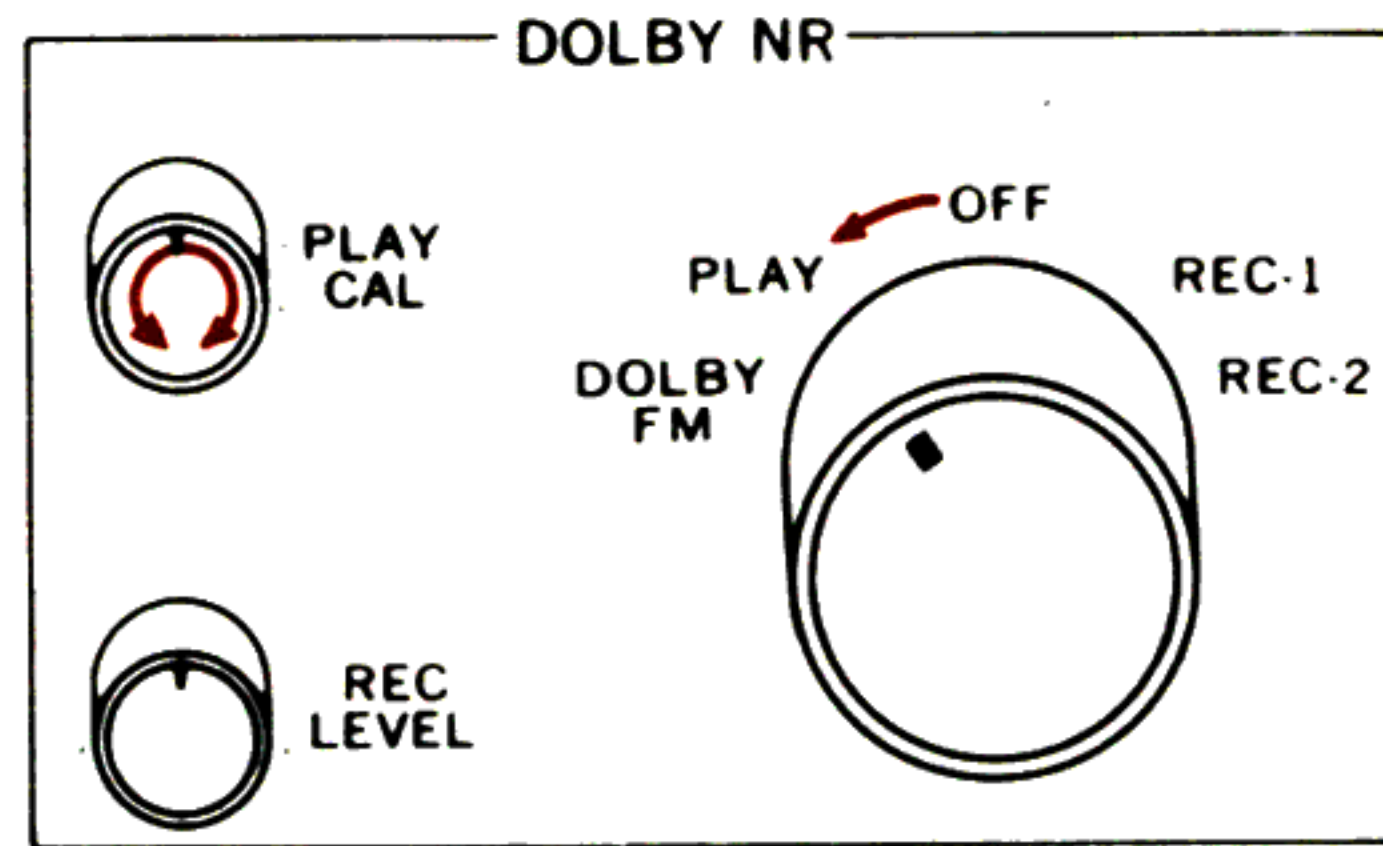
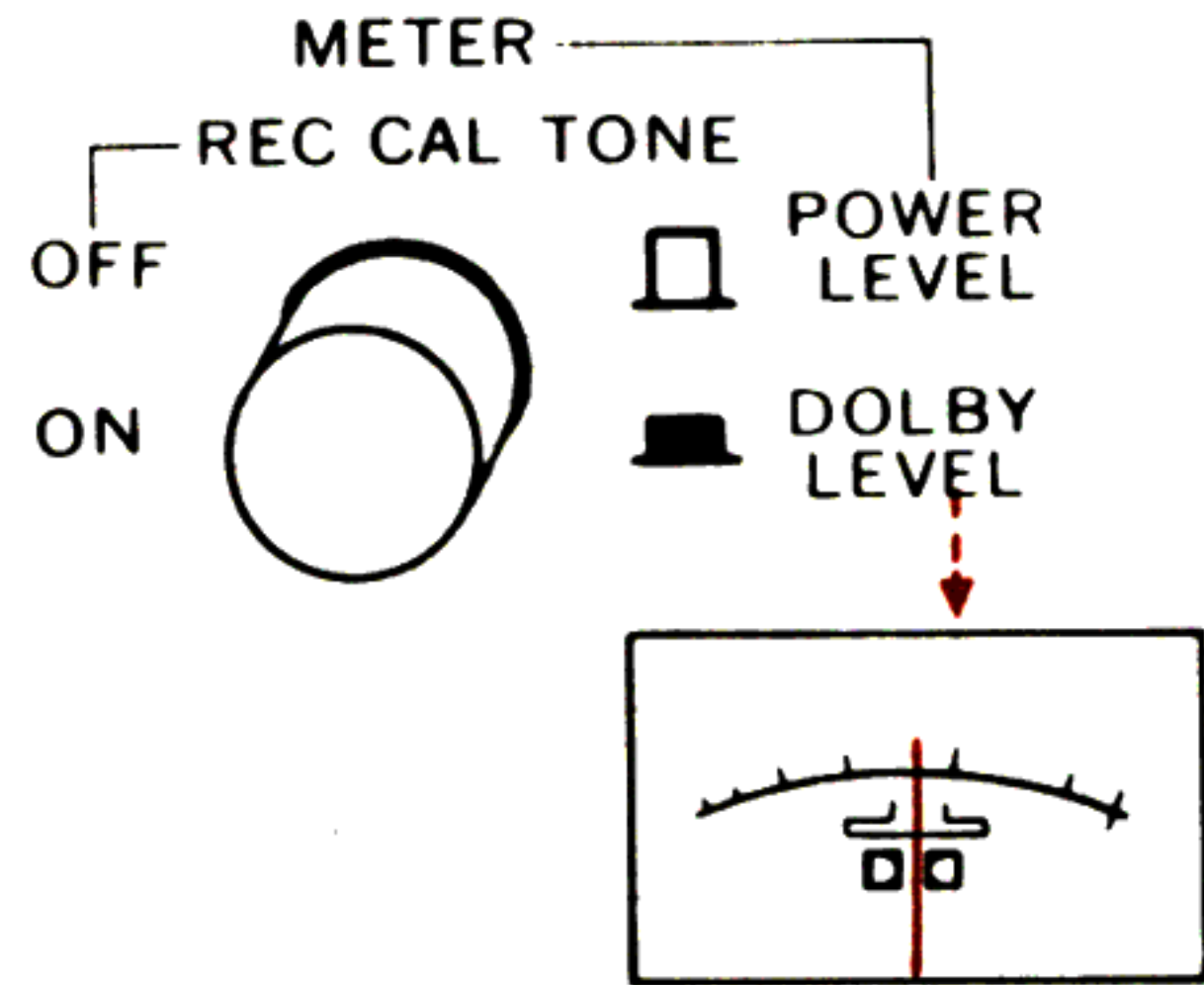
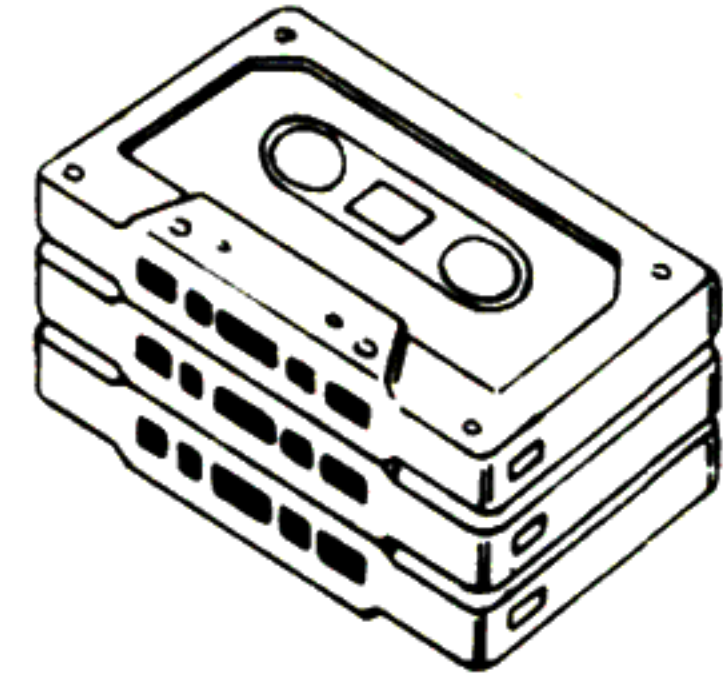
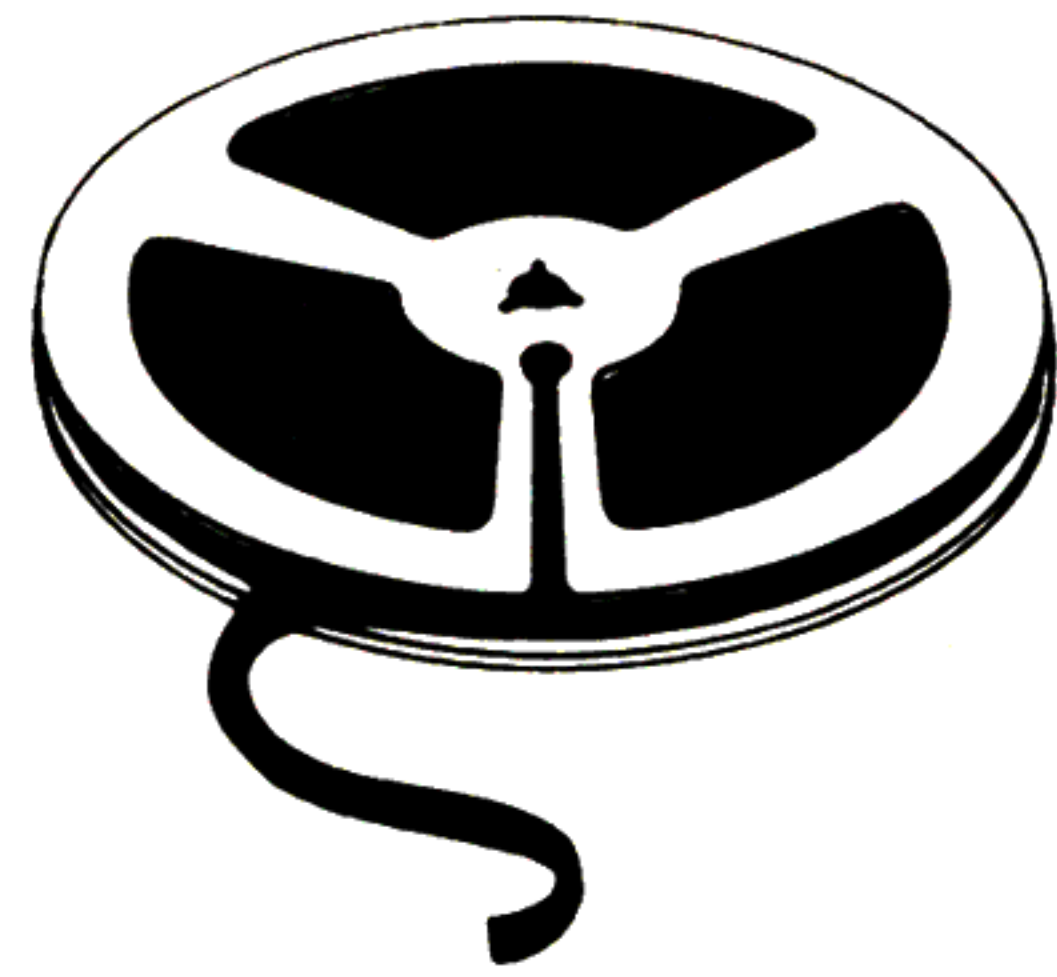

TAPE MONITOR

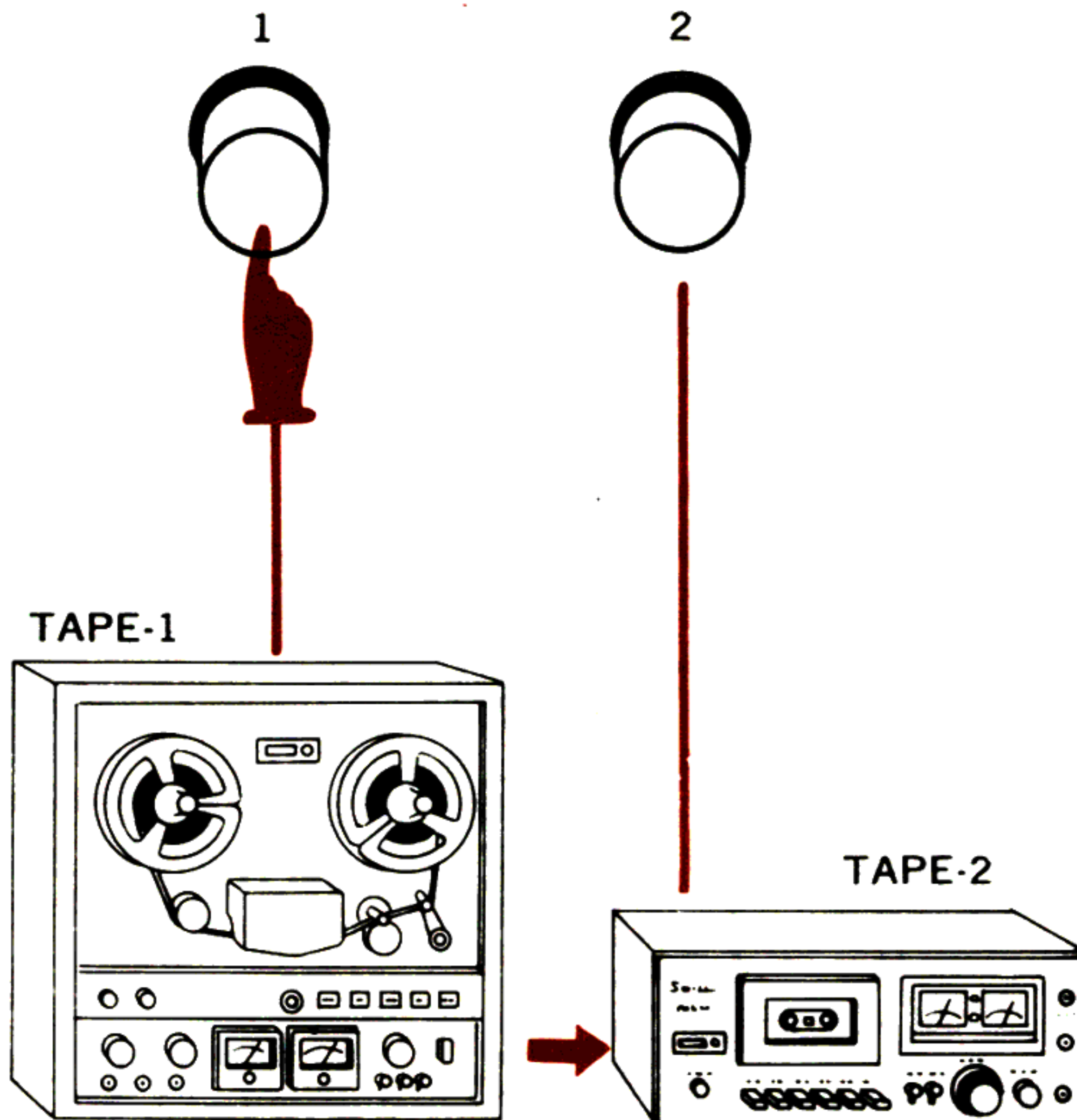

Playback of tapes

1. Confirm that the VOLUME control is not turned too far to the right; it should be at a position where you can obtain the normal listening level.
2. Push the TAPE MONITOR-1 or -2 switch, whichever is applicable for the tape deck you wish to use.
3. Operate the tape deck to start playback.
4. Adjust the unit's other controls and switches to suit the type of music you are going to hear.

Playback of Dolbyized tapes

1. Adjust the playback level controls of your tape deck to the "Dolby level calibrated point" (see pages 24, 25).
 2. Set the DOLBY NR switch to PLAY.
 3. Push the TAPE MONITOR-1 or -2 switch, whichever is applicable for the tape deck you wish to use.
- Be sure to confirm that the PLAY CAL control is still set at the adjusted position (see pages 24, 25).

Dubbing from TAPE-1 to TAPE-2

1. Push the TAPE MONITOR-1 switch. Do not push the TAPE MONITOR-2 switch unless you wish to monitor the recording as you record.
 2. Play back the desired tape on the tape deck connected to TAPE-1, and record it into the tape deck connected to TAPE-2.
- If you wish to do the dubbing (recording) through the built-in Dolby Noise Reduction system, set the DOLBY NR switch to REC-2, then adjust the record level controls of the TAPE-2 tape deck to the "Dolby level calibrated point" (see pages 24, 25).

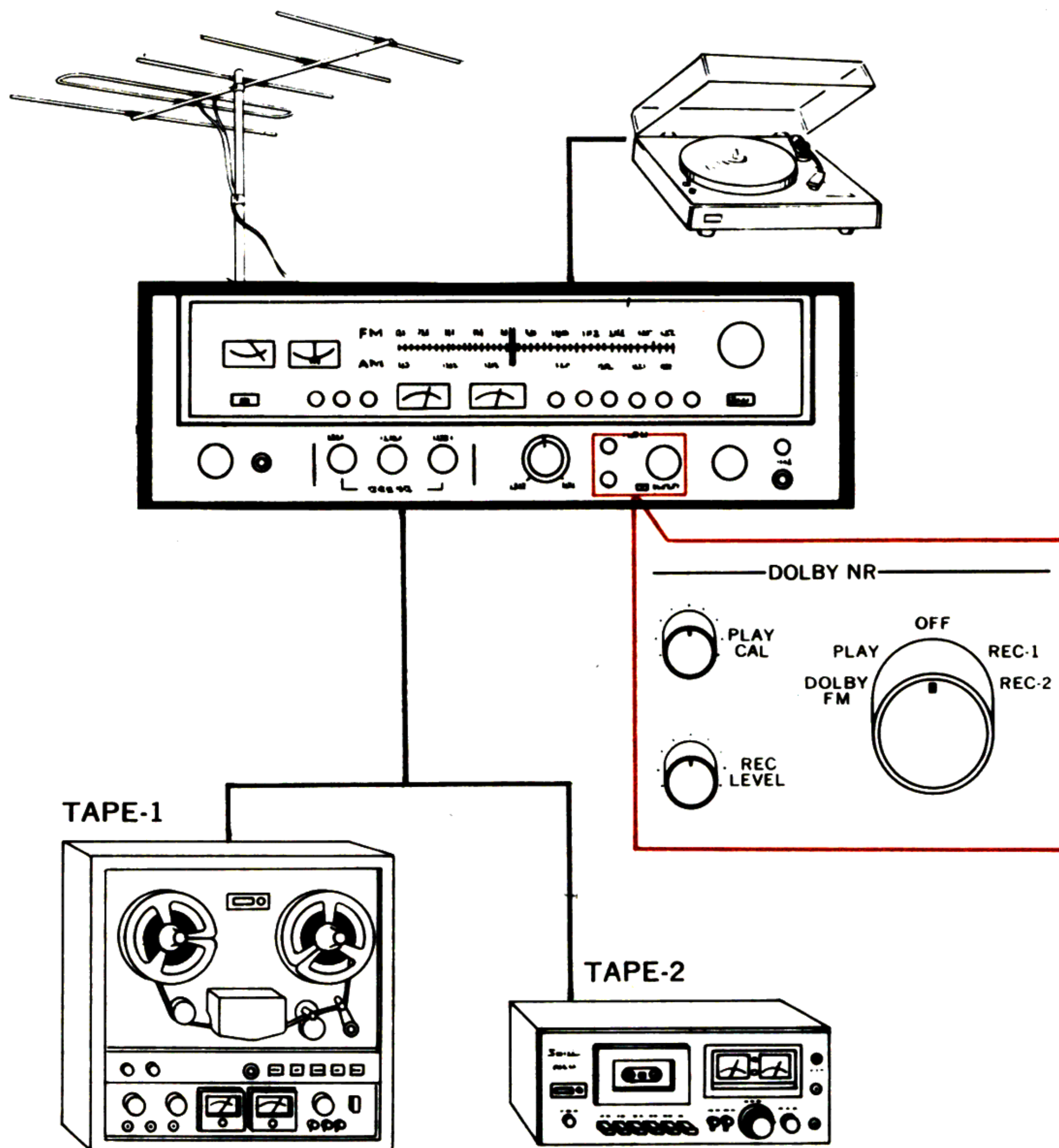

Recording disc records and radio broadcasts

1. Adjust the SELECTOR switch to suit the program source you wish to record.
2. Keep the DOLBY NR switch at OFF, but if you are recording a Dolbyized FM broadcast, set it to DOLBY FM.
 - If you record a Dolbyized FM broadcast into the tape deck connected to the TAPE-1 terminals, you'll create a Dolbyized tape. If you record it into the one connected to the TAPE-2 terminals, the recorded tape will be a "non-Dolbyized" tape.
3. Adjust the tape deck for proper record levels, then enter the record mode.
4. If the tape deck is of a 3-head type, you can monitor the recording as you make it. Operate the TAPE MONITOR switches in the same way as for playback.
 - Set the MONO switch to the stereo position (protruding), when recording is required.

Recording through the built-in Dolby

1. Select the program source.
2. Set the DOLBY NR switch to REC-1 or -2, whichever is applicable for the tape deck you wish to use.
3. Adjust the record level controls of the tape deck to the "Dolby level calibrated point" (see pages 24, 25), then adjust the REC LEVEL control of this unit for proper record levels.
4. Operate the tape deck to begin recording.
 - If your tape deck is equipped with the Dolby Noise Reduction, set the unit's DOLBY NR switch to OFF and operate at the tape deck's side to record or play back a tape through the Dolby Noise Reduction.
 - The Dolby noise reduction system does not work for both recording and playback simultaneously. Keep the TAPE MONITOR switches at SOURCE and hear the source.

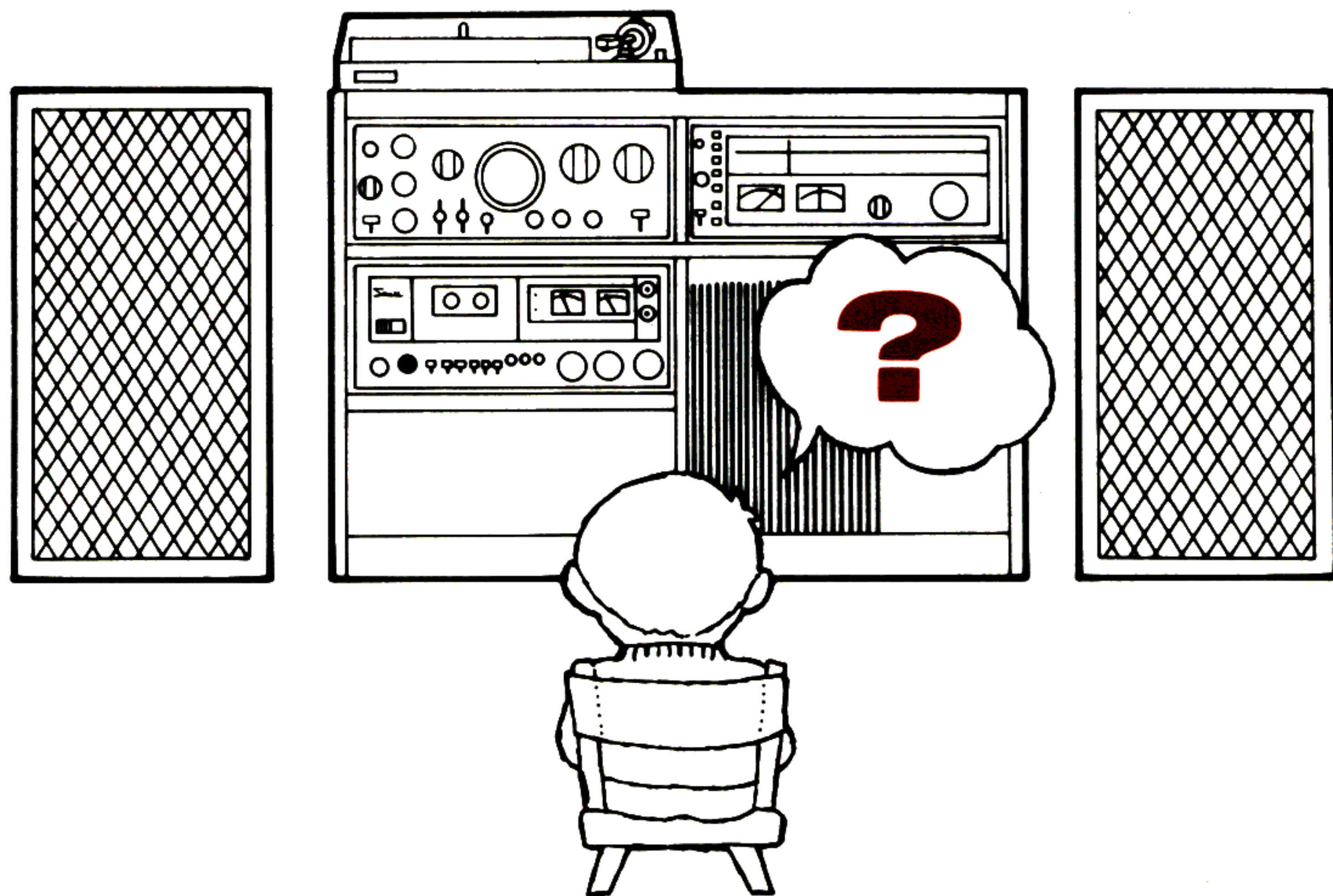

When you hear no sound

Some of the symptoms which seem to indicate a breakdown of the unit are caused by misoperation of the unit or other connected components. Confirm the connections and your operating procedure once more. Be sure to turn the power off or reduce the volume beforehand.

Check list of operation

1. Is the POWER switch turned ON?
2. If tape playback cannot be heard, is the TAPE MONITOR switch in the depressed position?
3. Is the SELECTOR switch turned to the correct position?
4. Is the SPEAKERS switch turned to the correct position?

Check list of connections

1. Is the power cord inserted in a wall AC outlet?
2. Are the connection cords for your turntable and tape deck loose or touching some other object?
3. Are the speaker connection cords loose from the unit or the speakers?

SOME USEFUL HINTS

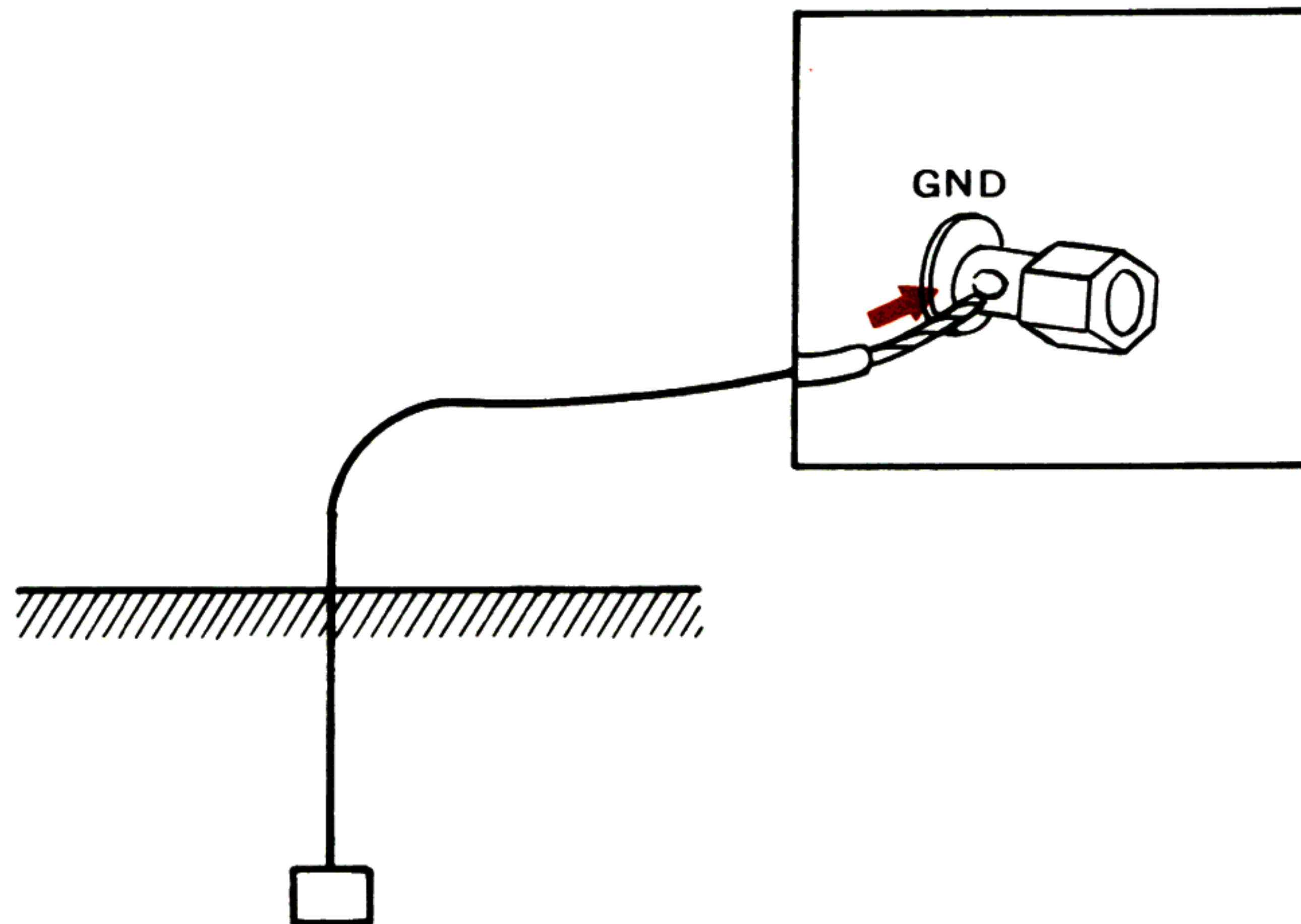
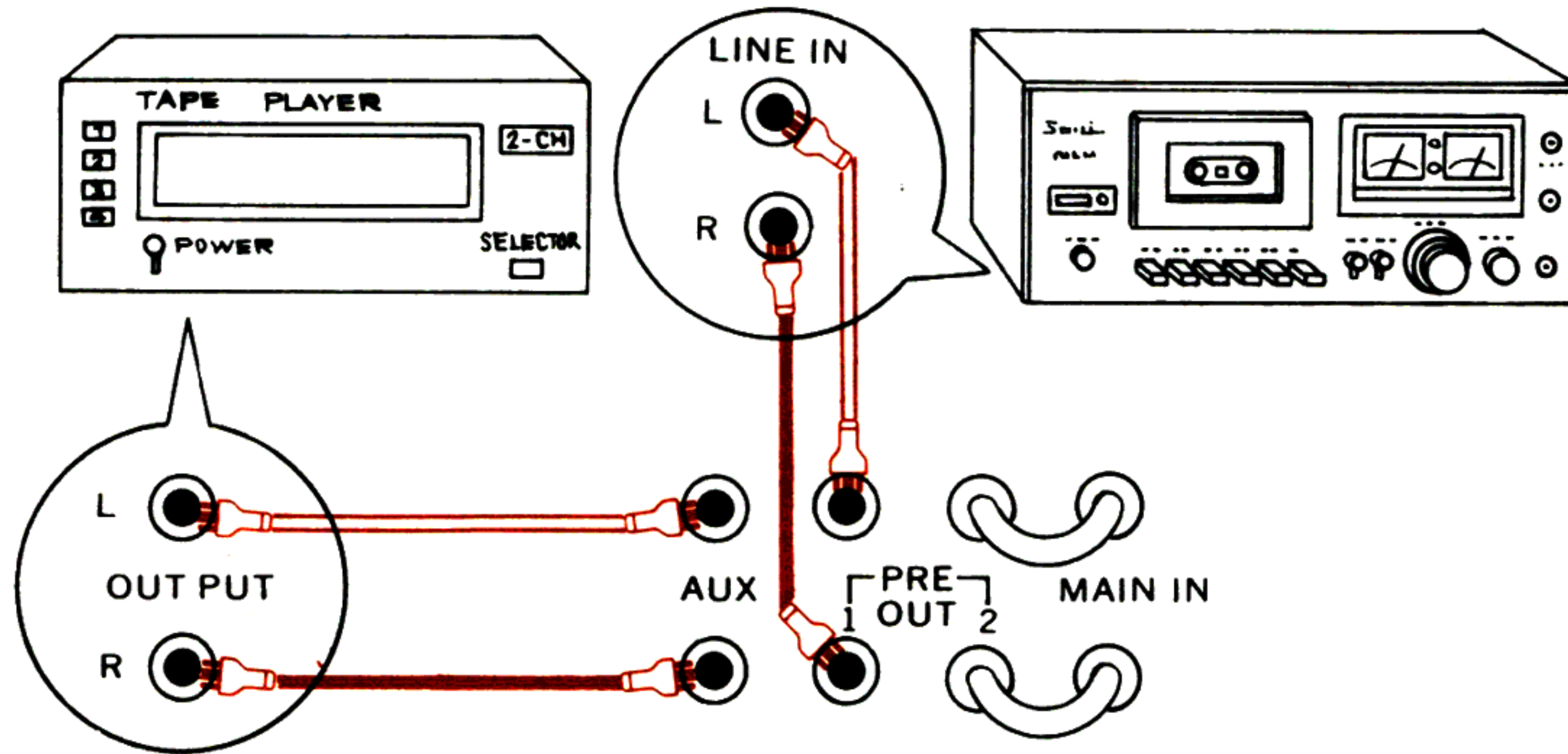

How to use AUX inputs

"AUX" means auxiliary, and the AUX inputs have the same electrical function as the TAPE PLAY inputs. They therefore connect a tape deck, a CD-4* demodulator, an adaptor for special cartridges, and other equipment that provides about the same output level as the afore-mentioned components.

*CD-4 is a trademark of JVC, Inc.

About PRE OUT-1 Terminals

If you connect these with the input terminals of a tape deck, you can record the mixture of a program source and the sound from any connected microphone (to accomplish what is sometimes called "mixing recording"), or record the sound of any program source as controlled by the bass, midrange and treble tone controls. An external power amplifier may also be connected to these terminals.

Grounding

Grounding the unit may reduce hum during record playback and noise during AM reception.

Grounding the unit to earth

Connect one end of a vinyl or enameled insulated cord to the GND terminal of the unit and the other end to a copper plate or carbon bar. Then bury the plate or bar deep under the ground. The other end of the cord may be connected to a metal water pipe. NEVER connect it to gas pipe, since it is dangerous. Earth grounding of the unit is unnecessary when one of the connected components is already grounded to earth.

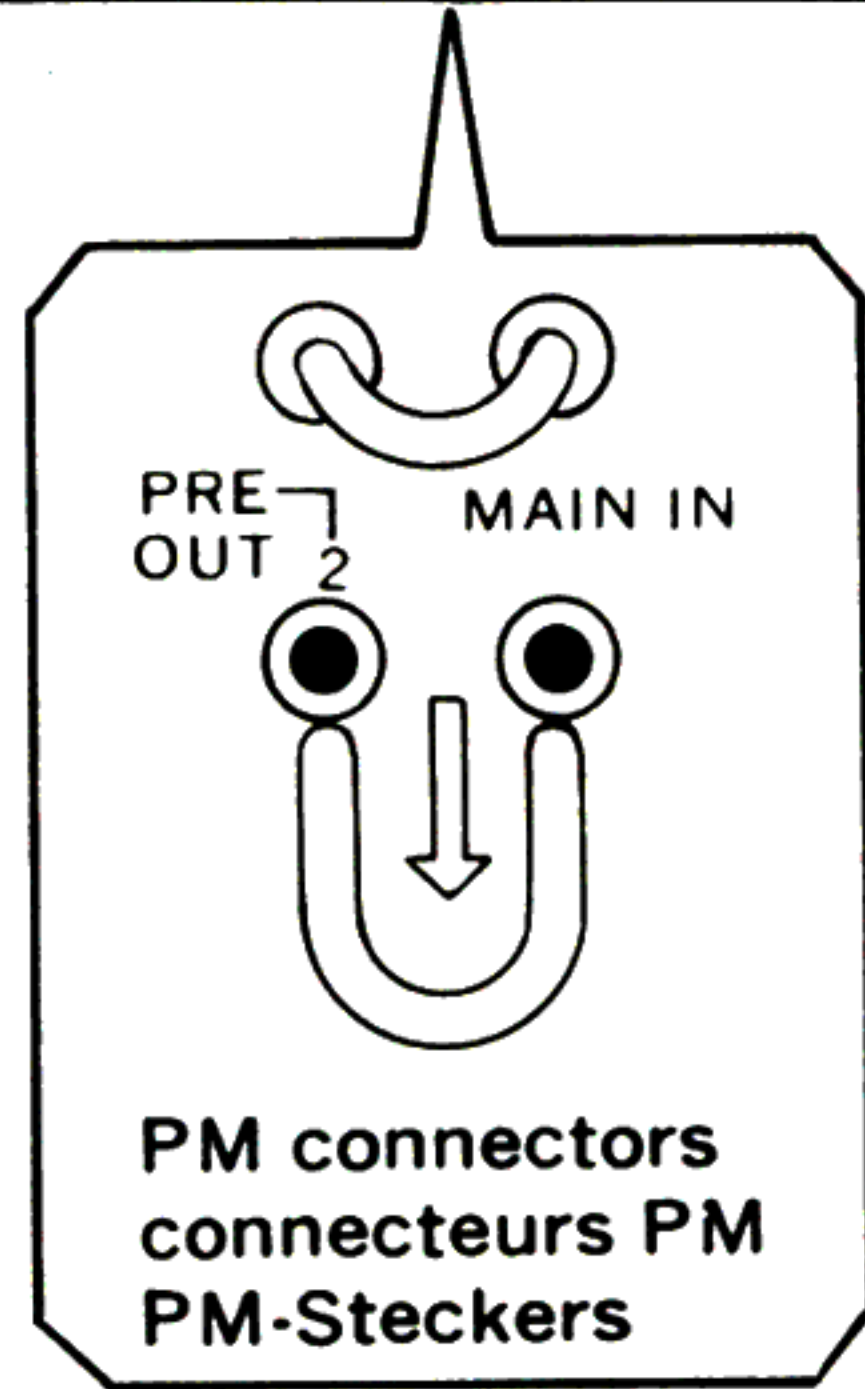
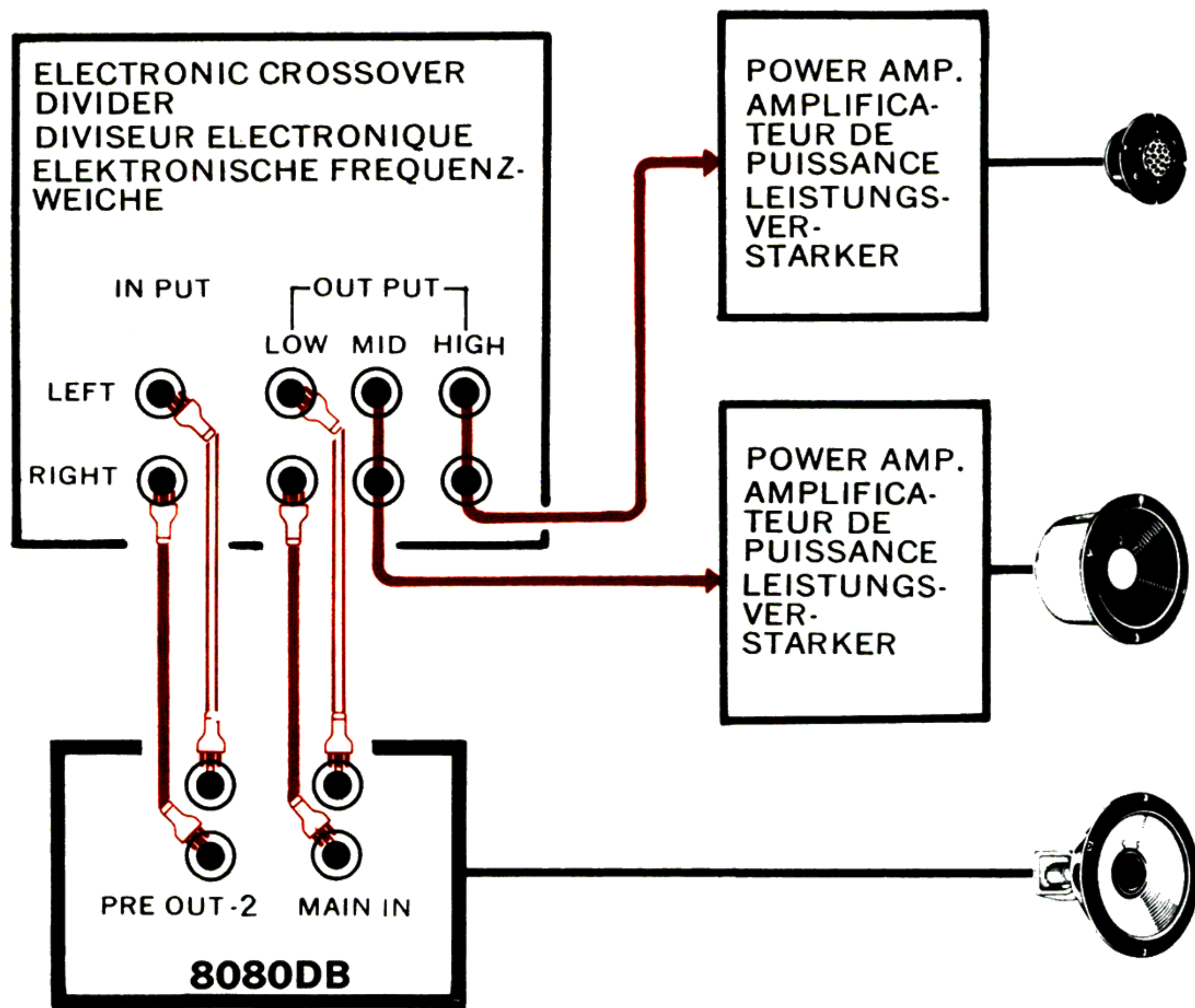

Separating the preamplifier/power amplifier

Pulling the PM connectors out from the rear panel of this unit separates the preamplifier and main (power) amplifier sections, so that they may be used independently. An external preamplifier or power amplifier can then be connected. Also, if you are building a multi-amplifier audio system using an electronic crossover unit, the preamplifier output and the power amplifier input terminals will be convenient. More specifically, the PRE OUT terminals should connect the input terminals of the electronic crossover unit or the additional power amplifier, while the MAIN IN terminals should connect the output terminals of the electronic crossover unit or an additional preamplifier.

- Keep the PM connectors plugged in at all other times, or you'll hear no sound from the speaker systems.

Outdoor FM antenna installation

For noise-free high-quality radio reception, an antenna is indispensable. Install an outdoor FM antenna referring to instructions on page 42 and 43. You can then avoid ignition noise and other type of noise as well as tonal deterioration by multi-path reflections. Antennas are prerequisite for quality FM reception in areas far from radio stations or in areas where there are high-rise buildings, mountains or other wave-reflecting objects.

The T-shaped FM antenna supplied should be used only until you install an outdoor antenna.

The lead-in cable should be of the 75-ohm coaxial type, for it suppresses intrusion of noise more effectively than the 300-ohm twin lead type.

- Since you have to select the FM antenna and lead-in cable best suited for your area, you are advised to consult with your nearest electric appliance dealer prior to purchase.

For better FM reception

Compared with AM, FM is inherently of higher quality with less noise and less interferences. Here are some hints for further improved FM reception.

Multi-path phenomenon and antenna alignment

FM waves are directional (more directional than AM), possessing a tendency to beam in a straight line. When hitting an obstacle, they simply reflect. Antennas receive the waves reflected by nearby obstacles (such as mountains and tall building) as well as the wave beamed direct from the station. The result is a multi-path phenomenon, the same problem which is the cause of "ghosts" on TV screen. In FM, reflection can cause distortion and poor stereo separation. Use an FM antenna with good directionality and align it correctly to minimize such distortion.

When hearing FM noise

As mentioned above, FM offers less noisy reproduction. However, noise may be increased by the causes described below.

Weak antenna input—When antenna input is too weak, the signal-to-noise ratio (the relative levels of the desired signal vs. The noise generated inside the unit and by extraneous signals) may deteriorate. The causes may be:

- * Improper antenna location.
- * Use of a low-gain T-shaped feeder cable. (Replace it for an outdoor antenna.)
- * Use of common antenna with a TV set.

Nearby electric appliances—Pulsive noises, caused by electrical sparks, may be mixed into audio signals. Major sources of such noises are automobiles (ignition plugs), electric trains, high-tension lines, fluorescent lamps, welding machines, etc. Therefore, you suffer less noise when the antenna is placed as far away as possible from such sources of noise.

As for the lead-in cables, the 300-ohm feeder type is very susceptible to external noise. Therefore, when you are living in a crowded urban or industrial area, use the 75-ohm coaxial cable which is specially shielded against noise.

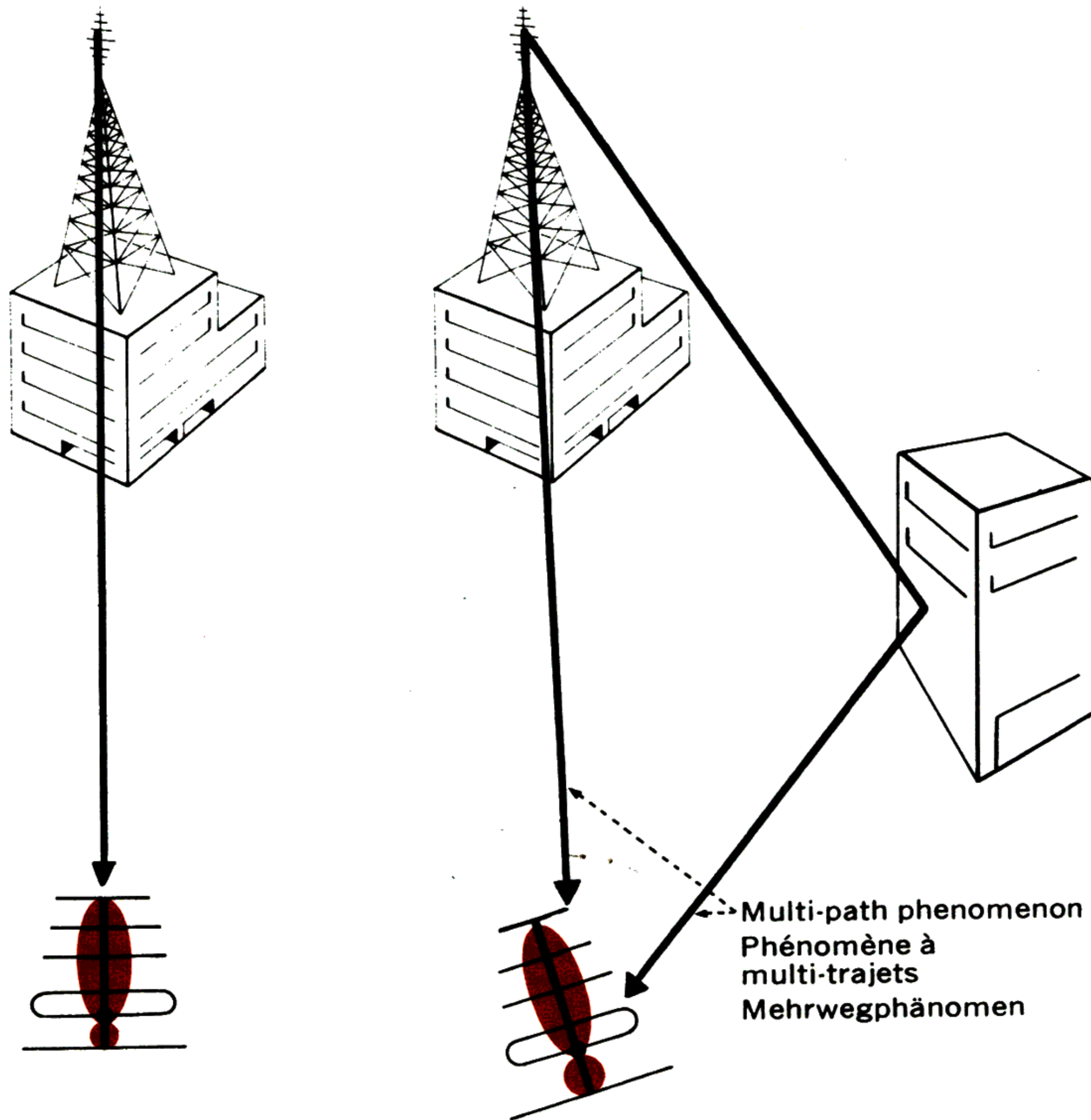

For better AM reception

Following are some hints for better AM reception.

When receiving weak stations:

When the unit is tuned to a weak AM station, you hear lower volume than when it receives a strong one. This may be corrected by re-aligning the rear-panel AM ferrite bar antenna. If the unit is used in a concrete building, AM volume may be increased by placing it by a window or air shaft. For best AM reception, you are advised to install an outdoor AM antenna.

When hearing AM noise:

AM noise can be caused by one of the following reasons.

Interference—Interference causes an audible, high-pitched beat. To avoid it, re-align the direction of the antenna. Also note that an outdoor antenna may also increase the noise level of a desired station by accidentally pulling in interference from other stations. Re-alignment in this case is also necessary.

Hum—Booming hum noise is often caused by the power source and is heard as 60 Hz (or 50 Hz) sound. It may be reduced by moving the unit away from other electric appliances or by reversing the unit's power cord plug/receptacle connections. Proper grounding may also be effective in reducing hum.

Buzz—Buzz noise is caused by fluorescent lamps and other electric appliances, or by natural phenomena such as thunder. Installation of a noise-suppression device may be effective. Since complete elimination of AM buzz is usually impossible, it is suggested that you make it less audible with the high filter or treble tone control on your amplifier.

SPECIFICATIONS

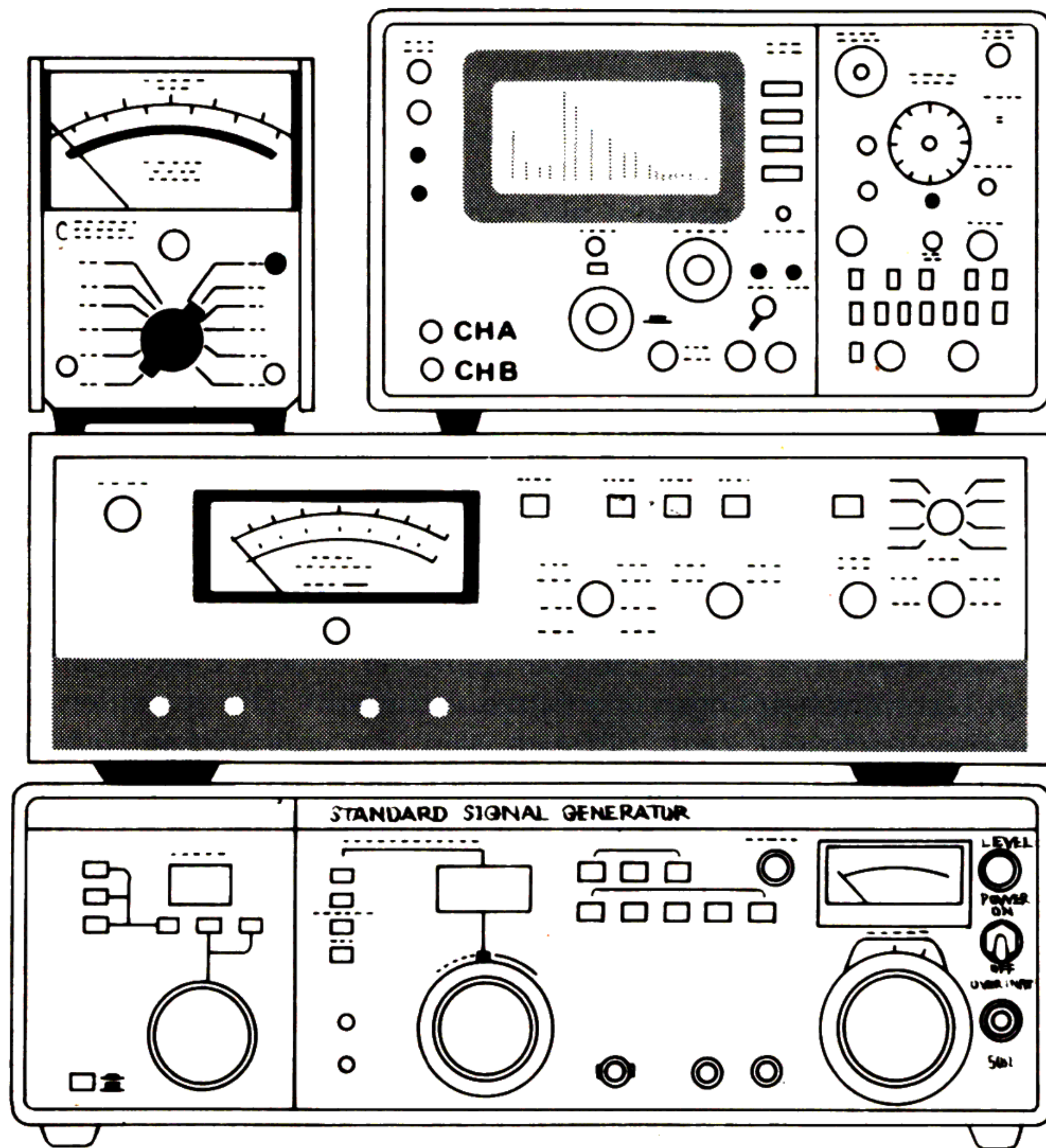

Audio section

Power output

Min. RMS, both channels driven, from 20 to 20,000 Hz, with no more than 0.1% total harmonic distortion

85 watts per channel into 8 ohms

Min. RMS, both channels driven, at 1,000 Hz, with no more than 0.1% total harmonic distortion
95 watts per channel into 8 ohms

Load impedance 8 ohms

Power bandwidth 20 to 20,000 Hz at or below rated min. RMS power output and total harmonic distortion

Total harmonic distortion less than 0.1% at or below rated min. RMS power output

Intermodulation distortion (70 Hz : 7 kHz = 4 : 1 SMPTE method) less than 0.1%

Frequency response (at 1 watt) 10 to 30,000 Hz \pm 1dB

RIAA curve deviation (PHONO) +0.3dB, -0.3dB
(30 Hz to 15 kHz)

Damping factor approximately 30 at 8-ohm load

Input sensitivity and impedance (1 kHz, for rated power output)

PHONO-1, 2 2.5 mV/50 kilohms

(Max. input capability: 180 mV at 1 kHz, less than 0.2% total harmonic distortion.)

MIC. 4 mV/10 kilohms

TAPE-1, 2 PLAY, AUX 150 mV/50 kilohms

MAIN IN 775 mV/100 kilohms

Output level (1,000 Hz)

TAPE-1, 2-REC (pin jacks) 150 mV

TAPE-2 REC/PLAY (DIN socket) 30 mV

PRE OUT 775 mV

Channel separation (at rated output 1,000 Hz)

PHONO-1, 2 better than 50dB

TAPE-1, 2 PLAY, AUX better than 50dB

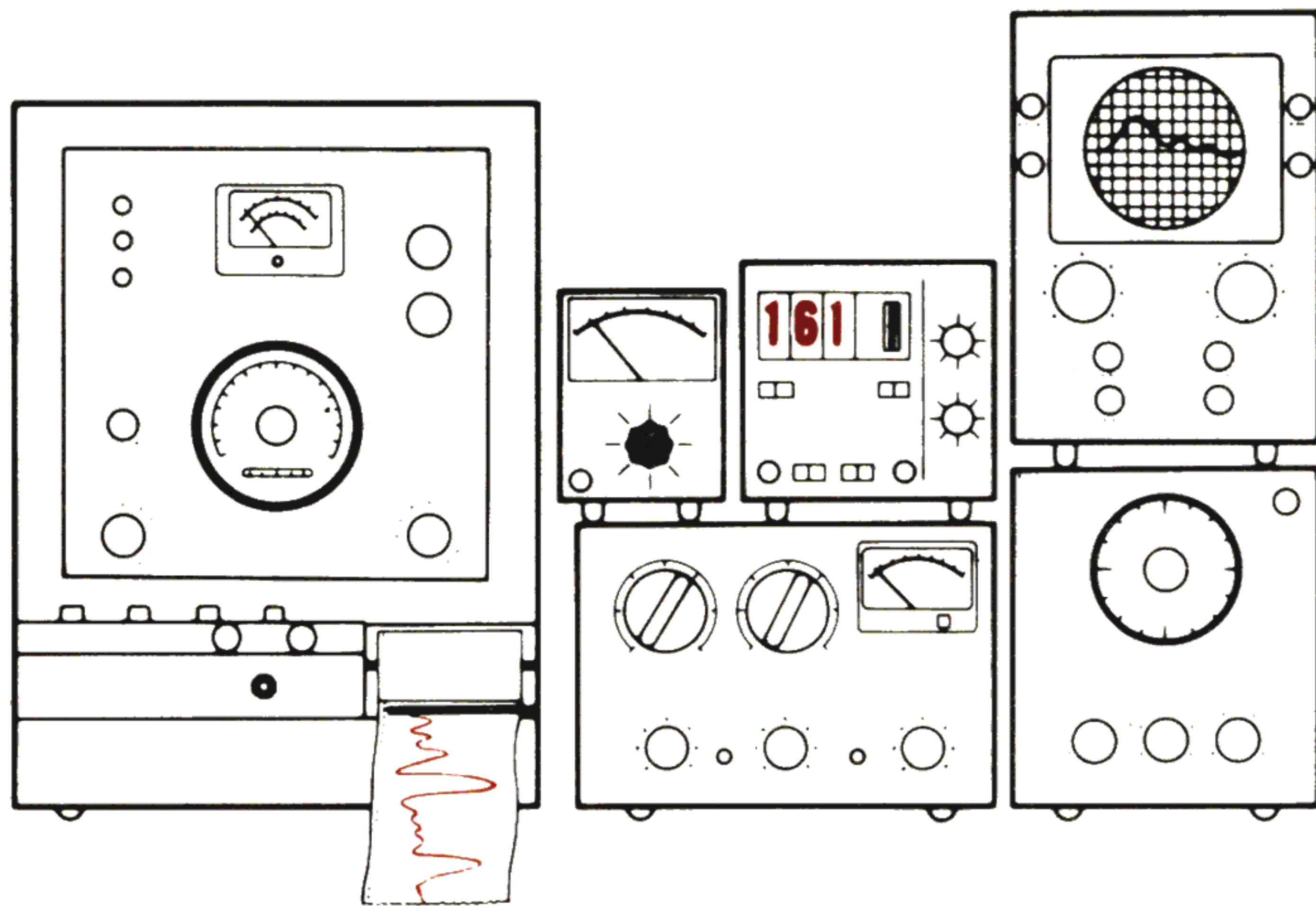

Hum and noise

PHONO-1, 2 better than 70dB

TAPE-1, 2 PLAY, AUX better than 80dB

Dolby Noise Reduction effect 10dB (above 5 kHz)

Controls

BASS ±10dB (50 Hz)

MIDRANGE ±5dB (1.5 kHz)

TREBLE ±10dB (10 kHz)

LOUDNESS +8dB (50 Hz)

+6dB (10 kHz)

LOW FILTER -10dB (50 Hz)

HIGH FILTER -10dB (10 kHz)

AUDIO MUTING -20dB

FM Section

Tuning range 88 to 108 MHz

Sensitivity (IHF) 9.8dBf (1.7 μV)

(DIN) 0.9 μV

50dB quieting sensitivity

Stereo (IHF) 36.3dBf (36 μV)

Mono (IHF) 14.7dBf (3 μV)

Total harmonic distortion

Stereo less than 0.3%

Mono less than 0.2%

Signal to noise ratio (mono) better than 70dB

Selectivity better than 85dB

Capture ratio less than 1.5dB

AM suppression better than 55dB

Image response ratio (IHF) better than 70dB (98 MHz)

IF response ratio (IHF) better than 95dB (98 MHz)

Spurious response ratio (IHF) better than 85dB (98 MHz)

Spurious radiation less than 34dB

Stereo separation better than 40dB (1 kHz)

Frequency response 30 to 15,000 Hz ±0.5 dB

Antenna input impedance 75 Ω unbalanced

300 Ω balance

AM Section

Tuning range	535 to 1,605 kHz
Sensitivity (Bar antenna)	50dB/m (1,000 kHz)
Selectivity	better than 50dB (1,000 kHz)
Image response ratio (IHF)	better than 30dB (1,000 kHz)
IF response ratio	better than 30dB (1,000 kHz)

Others

Power requirements

Power voltage	100, 120, 220, 240 V 50/60 Hz 120 V (Usable 110–130 V) 60 Hz (for U.S.A. & Canada only)
-------------------------	--

Power consumption

Maximum consumption	420 watts
Rated consumption	265 watts (350 VA)

Dimensions	540 mm (21-5/16") W 182 mm (7-3/16") H 397 mm (15-11/16") D
-----------------------------	---

Weight	20.7 kg (45.6 lbs) net 23.1 kg (50.9 lbs) packed
-------------------------	---

- * **Design and specifications subject to changes without notice for improvements.**
- * **In order to simplify the explanation illustrations may sometimes differ from the originals.**



SANSUI ELECTRIC CO., LTD.

14-1 Izumi 2-Chome, Suginami-ku, TOKYO 168, JAPAN
TELEPHONE: (03) 323-1111/TELEX. 232-2076