



McIntosh Laboratory, Inc. 2 Chambers Street Binghamton, New York 13903-2699 Phone: 607-723-3512 www.mcintoshlabs.com

MA6700
Integrated Amplifier
MAC6700
Receiver
Owner's Manual

HD Radio®
This HD Radio receiver enables:

- PSD
- HD2/HD3
- Digital Sound



The lightning flash with arrowhead, within an equilateral triangle, is intended to alert the user to the presence of uninsulated “dangerous voltage” within the product’s enclosure that may be of sufficient magnitude to constitute a risk of electric shock to persons.

WARNING - TO REDUCE RISK OF FIRE OR ELECTRICAL SHOCK, DO NOT EXPOSE THIS EQUIPMENT TO RAIN OR MOISTURE.

IMPORTANT SAFETY INSTRUCTIONS!

PLEASE READ THEM BEFORE OPERATING THIS EQUIPMENT.

1. Read these instructions.
2. Keep these instructions.
3. Heed all warnings.
4. Follow all instructions.
5. Do not use this apparatus near water.
6. Clean only with a dry cloth.
7. Do not block any ventilation openings. Install in accordance with the manufacturer’s instructions.
8. Do not install near any heat sources such as radiators, heat registers, stoves, or other apparatus (including amplifiers) that produce heat.
9. Do not defeat the safety purpose of the polarized or grounding-type plug. A polarized plug has two blades with one wider than the other. A grounding type plug has two blades and a



AVIS RISQUE DE CHOC ELECTRIQUE - NE PAS OUVRIR.

NO USER-SERVICEABLE PARTS INSIDE. REFER SERVICING TO QUALIFIED PERSONNEL.

third grounding prong. The wide blade or the third prong are provided for your safety. If the provided plug does not fit into your outlet, consult an electrician for replacement of the obsolete outlet.

10. Protect the power cord from being walked on or pinched particularly at plugs, convenience receptacles, and the point where they exit from the apparatus.
11. Only use attachments/accessories specified by the manufacturer.
12. Use only with the cart, stand, tripod, bracket, or table specified by the manufacturer, or sold with the apparatus. When a cart is used, use caution when moving the cart/apparatus combination to avoid injury from tip-over.
13. Unplug this apparatus during lightning storms or when unused for long periods of time.
14. Refer all servicing to qualified service personnel. Servicing is required when the apparatus has been damaged in any way, such as power-



The exclamation point within an equilateral triangle is intended to alert the user to the presence of important operating and maintenance (servicing) instructions in the literature accompanying the appliance.

To prevent the risk of electric shock, do not remove cover or back. No user-serviceable parts inside.

supply cord or plug is damaged, liquid has been spilled or objects have fallen into the apparatus, the apparatus has been exposed to rain or moisture, does not operate normally, or has been dropped.

15. Do not expose this equipment to dripping or splashing and ensure that no objects filled with liquids, such as vases, are placed on the equipment.
16. To completely disconnect this equipment from the a.c. mains, disconnect the power supply cord plug from the a.c. receptacle.
17. The mains plug of the power supply cord shall remain readily operable.
18. Do not expose batteries to excessive heat such as sunshine, fire or the like.
19. Connect mains power supply cord only to a mains socket outlet with a protective earthing connection.

Outdoor Antenna Grounding

If an outside antenna or cable system is connected to the product, be sure the antenna or cable system is grounded so as to provide some protection against voltage surges and built-up static charge. Article 810 of the National Electrical Code, ANSI/NFPA 70, provides information with regards to proper grounding of the mast and supporting structure, grounding of the lead-in wire to an antenna discharge unit, and size of ground conductors, location of antenna-discharge unit, connection to ground electrodes and requirements for the grounding electrode.

Example of antenna grounding as per National Electrical Code, ANSI/NFPA 70

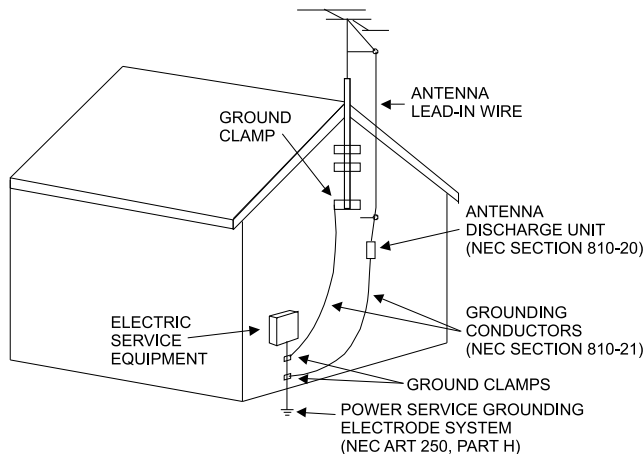

Thank You

Your decision to own this McIntosh MA6700 Integrated Amplifier or MAC 6700 Receiver ranks you at the very top among discriminating music listeners. You now have the best. The McIntosh dedication to precision performance assures many years of musical enjoyment.

Please take a short time to read the information in this manual. We want you to be as familiar as possible with all the features and functions of your new McIntosh.

Important Information

This Owner's Manual covers the McIntosh MA6700 Integrated Amplifier and the McIntosh MAC6700 Receiver. The Preamplifier and Power Amplifier Circuitry is identical in both models.

The MA6700 Integrated Amplifier allows for an optional Tuner Module to be installed at any time. The MAC6700 Receiver comes with the Tuner Module already installed from the factory.

When the information contained in this Owner's Manual refers to both models, MA6700 (with or without the Tuner Model installed) and MAC6700, it will be referred to as MA/MAC6700.

Please Take A Moment

The serial number, purchase date and McIntosh Dealer name are important to you for possible insurance claim or future service. The spaces below have been provided for you to record that information:

Serial Number: _____

Purchase Date: _____

Dealer Name: _____

Technical Assistance

If at any time you have questions about your McIntosh product, contact your McIntosh Dealer who is familiar with your McIntosh equipment and any other brands that may be part of your system. If you or your Dealer wish additional help concerning a suspected problem, you can receive technical assistance for all McIntosh products at:

McIntosh Laboratory, Inc.
2 Chambers Street
Binghamton, New York 13903
Phone: 607-723-3512
Fax: 607-724-0549

Customer Service

If it is determined that your McIntosh product is in need of repair, you can return it to your Dealer. You can also return it to the McIntosh Laboratory Service Department. For assistance on factory repair return procedure, contact the McIntosh Service Department at:

McIntosh Laboratory, Inc.
2 Chambers Street
Binghamton, New York 13903
Phone: 607-723-3515
Fax: 607-723-1917

Trademark and License Information

The McIntosh MA6700 and TM2 Tuner Module incorporates copyright protected technology that is protected by U.S. patents and other intellectual property rights. The MA6700 with optional TM2 Tuner Module uses the following Technologies:



HD Radio™, HD Radio Ready™, and the HD Radio Ready logo are proprietary trademarks of iBiquity Digital Corporation.

HD Radio Technology manufactured under license from iBiquity Digital Corporation. U.S. and Foreign Patents. HD Radio™ and the HD, HD Radio, and "Arc" logos are proprietary trademarks of iBiquity Digital Corp.

Copyright 2012, 2013 © by McIntosh Laboratory, Inc.



Table of Contents

Safety Instructions.....	2-3
Thank You and Important Information.....	3
Please Take a Moment, Technical Assistance	3
Customer Service, Trademark and License Information....	3
Table of Contents	4
General Information	4-5
Connector and Cable Information.....	5
Introduction	6
Amplifier Performance Features.....	6
Tuner Module Performance Features.....	7
Dimensions	8
Installation	9
Connections:	
Amplifier/Receiver Rear Panel Connections	10
(Separate Sheet)	Mc1A
Tuner Module and RAA2 Antenna Connections.....	11
Connecting Antennas (Separate Sheet).....	Mc1B
Connecting Components	12
Connection Diagrams (Separate Sheet).....	Mc2A/2B
Passthru Connections	13
Connecting Loudspeakers	14-15
Connecting for Bi-Amplification	16
Remote Control and Front Panel:	
Remote Control Push-buttons	18
How to use the Remote Control.....	19
Front Panel Displays, Controls, Push-buttons and Jack	20
Setup Mode:	
How to Operate the Setup Mode	21
Default Settings	21
Firmware Version	22
Source Input Reassignment.....	23
Source Input Renaming.....	24
Passthru	24
Power Control Triggers 1 and 2.....	24
Comm Port Baud Rate.....	25
Remote Control Codes	26
Power Mode.....	26
TM2 Tuner Module Firmware Version.....	27
TM2 Tuner Module Clear Presets.....	27

TM3 Tuner Module Firmware Version	28
TM3 Tuner Module Clear Presets	28
TM3 Tuner Regions.....	29
Amplifier Operation:	
How to Operate the MA/MAC6700.....	30
Power On/Off	30
Source Selection	30
Volume Control	30
Trim Functions:	
Balance, Bass, Treble.....	31
Trim Level and Tone Control.....	32
Mono/Stereo Mode and Phono Adjustments....	33
Display Brightness and Digital Audio Display	33
Meter Backlight and Tuner Control.....	34
Tuner Text and Tuner Blend Mode	35
Tone Bypass, Trim, Mute	35
Headphone Jack and Power Output Meters.....	36
Power Guard and How to Make a Recording.....	36
Using a Separate Power Amplifier.....	36
Using Output 2 and Passthru.....	37
USB Input Operation with a Computer.....	37
Reset of Microprocessors	37
Resetting the MA/MAC6700 to default settings	37
TM2 and TM3 Tuner Operation:	
Operating the TM2 and TM3 Tuner.....	39
AM or FM Band Selection	39
Manual Tuning	39
Preset Tuning.....	39
Creating Presets.....	40
Clearing Presets.....	40
Automatic Tuning.....	40
Direct Access Tuning	41
Stereo/Mono Mode.....	41
Text information	41
HD Radio Reception	41
Manual HD Radio Program Selection	442
Selecting HD Radio Program Preset	40
Specifications.....	43-46
Packing Instructions	47

General Information

1. For additional connection information, refer to the owner's manual(s) for any component(s) connected to the MA/MAC6700.
2. Apply AC Power to the MA/MAC6700 and other McIntosh Component(s) only after all the system components are connected together. Failure to do so may cause a malfunction of system operations as the Microprocessor's Circuitry inside the components is active when AC Power is applied.
3. **The MA/MAC6700 includes an Auto Off Power Save Feature and the default setting is enabled.** For additional information including how to disable it, refer to page 26.
4. The type and availability of the optional Tuner Module for the MA6700 (sold separately) and the factory installed Tuner Module in the MAC6700 varies from country to country. Contact your McIntosh Dealer for additional information.
5. When Power Amplifier Protection Circuitry of the MA/MAC6700 has activated, the Front Panel Power Guard LEDs are illuminated continuously and the sound will be muted.
6. When the Power Transformer has overheated due to improper ventilation and/or high ambient operating temperature, AC Power is removed from the MA/MAC6700. Normal operation will resume when the operating temperature is in a safe range again.
7. For the best performance and safety, it is important to always match the impedance of the Loudspeaker to the Power Amplifier connections. Refer to pages 14 thru 16.

Note: The impedance of a Loudspeaker actually varies as the Loudspeaker reproduces different frequencies. As a result, the nominal impedance rating of the Loudspeaker (usually measured at a midrange frequency) might not always agree

with the impedance of the Loudspeaker at low frequencies where the greatest amount of power is required. Contact the Loudspeaker Manufacturer for additional information about the actual impedance of the Loudspeaker before connecting it to the McIntosh MA/MAC6700.

8. The MA/MAC6700 Remote Control is capable of operating other components. For additional information go to www.mcintoshlabs.com.
9. The IR Input, with a 1/8 inch mini phone jack, is configured for non-McIntosh IR sensors such as a Xantech Model HL85BK Kit. Use a Connection Block such as a Xantech Model ZC21 when two or more IR sensors need to be connected to the MA/MAC6700. The signal from a connected External IR Sensor will have priority over the signal from the Front Panel IR Sensor.
10. When discarding the unit, comply with local rules or regulations. Batteries should never be thrown away or incinerated but disposed of in accordance with the local regulations concerning battery disposal. 
11. For additional information on the MA/MAC6700 and other McIntosh Products please visit the McIntosh Web Site at www.mcintoshlabs.com.

Connector and Cable Information

XLR Connectors

Below is the Pin configuration for the XLR Balanced Input Connectors on the MA/MAC6700. Refer to the diagram for connection:

- PIN 1: Shield/Ground
- PIN 2: + Output
- PIN 3: - Output

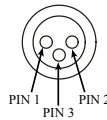

Power Control and Trigger Connectors

The Power Control Output Jacks send and Passthru Input Jack receives Power On/Off Signals (+12 volt/0 volt) when connected to other McIntosh Components. An additional connection is for controlling the illumination of the Power Output Meters on McIntosh Power Amplifiers. A 3.5mm stereo mini phone plug is used for connection to the Power Control, Trigger and Passthru Outputs.

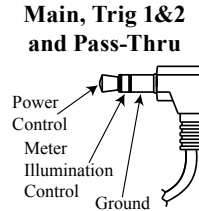

Data Port Connectors

The Data Out Ports send Remote Control Signals to Source Components. A 3.5mm stereo mini phone plug is used for connection.

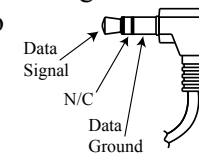

IR IN Port Connectors

The IR IN Port also uses a 3.5mm stereo mini phone plug and allows the connection of other brand IR Receivers to the MA/MAC6700.

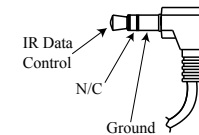

RS232-C Data Port Cable

The RS232 Data Cable is a 3.5mm stereo mini phone plug to a sub miniature DB 9 connector:

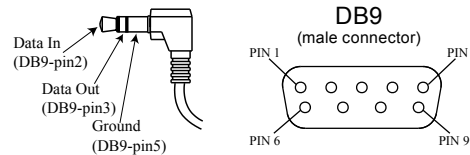

McIntosh Plug-In Jumper Connector

The MA/MAC6700 utilizes a phono style Plug-In Jumper to connect the Preamp Output to the Power Amplifier Input, one Jumper for each channel.

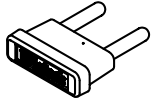

Note: The Jumper Connector is available from the McIntosh Parts Department: McIntosh Jumper Connector Part No. 117781

RAA2 Cable Connector

Pin No.	Wire Color	Pin No.	Wire Color
1.	White/Orange	5.	White/Blue
2.	Orange	6.	Green
3.	White/Green	7.	White/Brown
4.	Blue	8.	Brown

*Cable outer shield

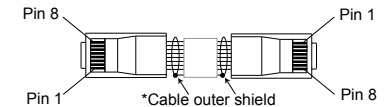

Note: The RAA2 Connecting Cable is available from the McIntosh Parts Department: RAA2 Antenna Cable Part No. 171844 Twenty foot, shielded 8 conductor, with a shielded RJ45 connector on each end.

FM Dipole Antenna

The MAC6700 Tuner Module or the addition of the optional Tuner Module for the MA6700 require the connection of an external Antenna for FM reception. A "FM Dipole Antenna" is available from the McIntosh Parts Department:

FM Dipole Antenna Part No. 173033

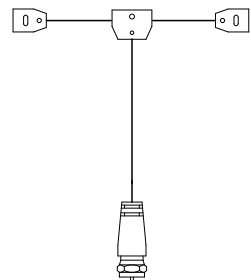



Introduction

Now you can take advantage of traditional McIntosh standards of excellence in the MA6700 Integrated Amplifier or MAC6700 Receiver. The Power Amplifier section of the MA/MAC6700, with a power output of 200 watts per channel, will drive a pair of quality Loudspeakers to a high level of performance.

The flexible Preamplifier section provides connections for various input sources and may also be used to drive an external Power Amplifier(s).

The MAC6700 tuner circuitry delivers the same exceptional performance as a stand-alone McIntosh Tuner. The MA6700 has provisions for adding an optional McIntosh AM/FM Tuner Module. The Tuner Module can be installed by your McIntosh Service Dealer at any time, usually while you wait.

The MA/MAC6700 reproduction is sonically transparent and absolutely accurate. The McIntosh Sound is “The Sound of the Music Itself.”

Amplifier Performance Features

• Power Output with Patented Autoformer

The MA/MAC6700 consists of a 200 watts per channel stereo Power Amplifier with less than 0.005% distortion. The McIntosh designed and manufactured Autoformer allows connection of 2, 4 or 8 ohm Loudspeakers. The Power Amplifier uses ThermalTrak¹ Output Transistors for lower distortion and cool operation.

• Power Guard

The patented McIntosh Power Guard circuit prevents amplifier clipping and protects your valuable Loudspeakers.

• Sentry Monitor and Thermal Protection

McIntosh Sentry Monitor power output stage protection circuits ensure the MA/MAC6700 will have a long and trouble free operating life. Built-in Thermal Protection Circuits guard against overheating.

• Electronic Switching and Balanced Connections

The Preamplifier uses Logic Circuits controlling Electromagnetic Switches on all inputs and operating functions for reliable, noiseless, distortion free switching. There is a Balanced Input for connection of source components.

• Digital Audio Inputs

The MA/MAC6700 has Coaxial, Optical and USB Digital Inputs to Decode PCM Signals from an external source. The MA/MAC6700 Up Samples the Digital Signal to 192kHz with 32Bit resolution before the Digital to Analog process begins.

• Moving Coil and Moving Magnet Phono Inputs

The MA/MAC6700 contains two different precision Phono Preamplifier Circuits. One for low output Moving Coil Phono Cartridges with selectable resistance loading, the other is for Moving Magnet Cartridges. Both circuits use the latest designs to provide the lowest possible noise and distortion. The RIAA Correction Equalization Circuitry utilizes close tolerance resistors and capacitors for an extremely flat frequency response.

• Multifunction Fluorescent Display

The Front Panel Display indicates source selection, volume levels, tone adjustments and setup functions.

• Illuminated Power Meters

The Illuminated Power Output Watt Meters on the MA/MAC6700 are peak responding, and indicate the power output of the amplifier.

• PassThru Mode

The Automatic PassThru Mode allows the MA/MAC6700 to become part of a Multichannel Sound System for DVD-Audio, SACD and Home Theater Movies.

• Power Control and Remote Control

The Power Control Output connection provides convenient Turn-On/Off of McIntosh Source Components. The Data Ports together with the supplied Remote Control provide control of McIntosh Source Components connected to the MA/MAC6700.

• Special Power Supply

The large Power Transformer, multiple filter capacitors with 120 Joules of Energy Storage and regulated Power Supply ensures stable noise free operation even though the power line varies.

• McIntosh Custom Binding Posts

McIntosh Patented gold plated output terminals deliver high current output. They accept large diameter wire and spade lugs. Banana plugs may also be used only in the United States and Canada.

• Fiber Optic Solid State Front Panel Illumination

The even Illumination of the Front Panel is accomplished by the combination of custom designed Fiber Optic Light Diffusers and extra long life Light Emitting Diodes (LEDs). The glass Front Panel ensures the pristine beauty of the MA/MAC6700 will be retained for many years.

¹ ThermalTrak™ and ON Semiconductor are trademarks of Semiconductor Components Industries, LLC

TM2 Tuner Module Performance Features

• Reception

The TM2 Tuner Module with HD Radio Technology allows for the reception of high quality FM and AM Radio Broadcasts in regions where available.

Digital Sound

Digital, CD-quality sound. HD Radio Technology enables local radio stations to broadcast a clean digital signal. AM sounds like today's FM and FM sounds like a CD.

HD2/HD3

Adjacent to traditional main stations are extra local FM channels. These HD2/HD3 Channels provide new, original music as well as deep cuts into traditional genre.

PSD

Program Service Data: Contributes to the superior user experience of HD Radio Technology. Presents song name, artist, station IDs, HD2/HD3 Channel Guide, and other relevant data streams.

• Special FM RF Circuitry

The Tuner Module RF Circuitry receives strong local FM Station Signals without distortion and receives even the weakest of FM Signals with low noise.

• High Dynamic Range IF FM Circuitry

The all important IF circuitry in the Tuner Module provides dynamic bandwidth control optimizing performance at all times with varying reception conditions.

• RAA2 External AM Antenna

The RAA2 External AM Antenna provides the perfect match to the Tuner Module AM Circuitry. The 20 foot

(6 meter) connection cable allows placement of the AM Antenna away from electronic equipment which can produce RF Interference to weak AM signals.

• Preset Stations and Permanent Memory

Twenty AM and Twenty FM station presets make it easy to listen to your favorite stations. Station Presets and Function Modes are retained in Permanent Memory even when AC power is switched Off.

• Multifunction Fluorescent Display

The Front Panel Display indicates Station Frequency, Signal Strength, Stored Station Presets and Tuner Setup Functions.

TM3 Tuner Module Performance Features

• Special FM RF Circuitry

The Tuner Module RF Circuitry receives strong local FM Station Signals without distortion and receives even the weakest of FM Signals with low noise.

• High Dynamic Range IF FM Circuitry

The all important IF circuitry in the Tuner Module provides dynamic bandwidth control optimizing performance at all times with varying reception conditions.

• Information Service

With this optional tuner module installed in the MA6700 and with the MAC6700, the Front Panel Display can display various text information from the Broadcast Station¹. This text information may include the Station Call Sign, Music Genre, Artist Name and Song Title.

• Preset Stations and Permanent Memory

Twenty AM and Twenty FM station presets make it easy to listen to your favorite stations. Station Presets and Function Modes are retained in Permanent Memory even when AC power is switched Off.

• RAA2 External AM Antenna

The RAA2 External AM Antenna provides the perfect match to the Tuner Module AM Circuitry. The 20 foot (6 meter) connection cable allows placement of the AM Antenna away from electronic equipment which can produce RF Interference to weak AM signals.

• Multifunction Fluorescent Display

The Front Panel Display indicates Station Frequency, Signal Strength, Stored Station Presets and Tuner Setup Functions.

¹ The display of text information is dependent on the Broadcast Station transmitted signal, the text information language and the Broadcast Station country of origin. The Tuner Module supports English Language Alphabet Characters.

Dimensions

The following dimensions can assist in determining the best location for your MA/MAC6700. There is additional information on the next page pertaining to installing the MA/MAC6700 into cabinets.

Front View of the MA/MAC6700

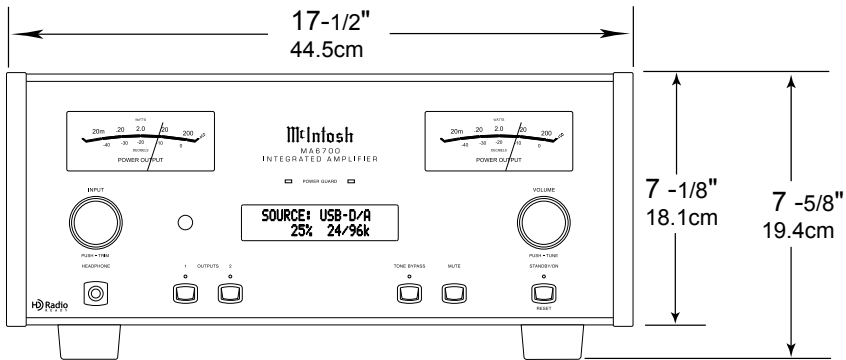

Rear View of the MA/MAC6700

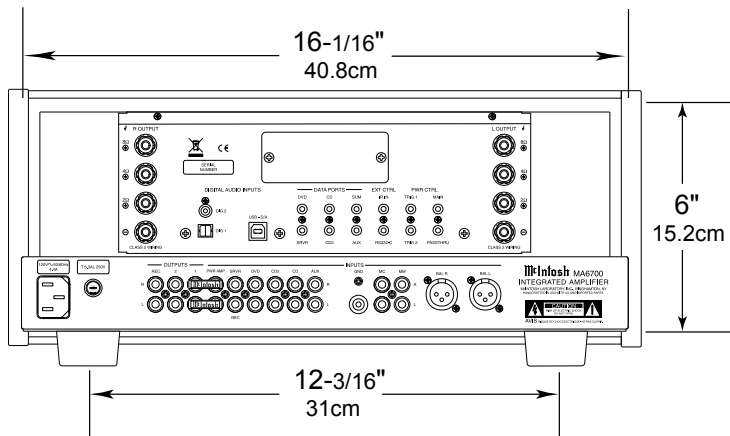

Side View of the MA/MAC6700

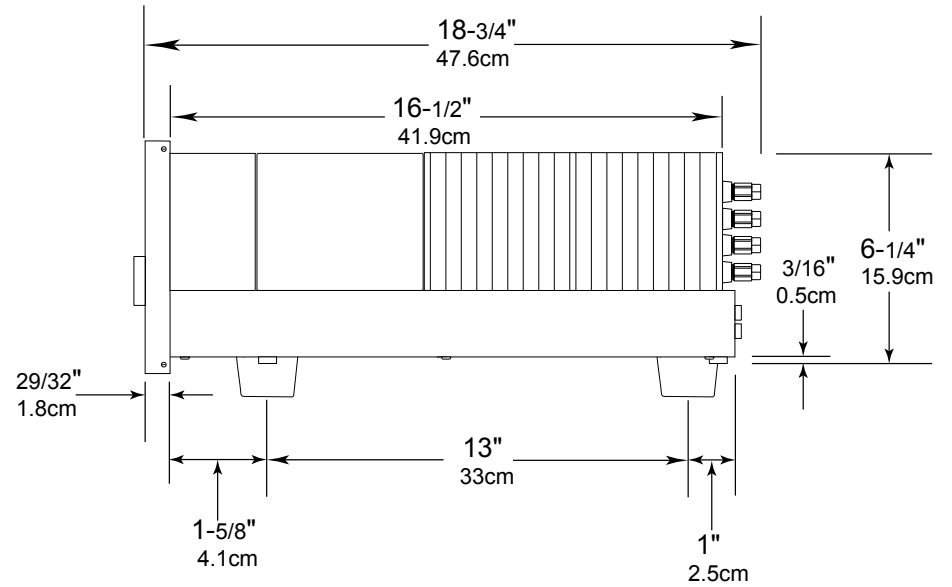

Installation

The MA/MAC6700 can be placed upright on a table or shelf, standing on its four feet. It also can be custom installed in a piece of furniture or cabinet of your choice. The four feet may be removed from the bottom of the MA/MAC6700 when it is custom installed as outlined below. The four feet together with the mounting screws should be retained for possible future use if the MA/MAC6700 is removed from the custom installation and used free standing. The required panel cutout, ventilation cutout and unit dimensions are shown.

Always provide adequate ventilation for your MA/MAC6700. Cool operation ensures the longest possible operating life for any electronic instrument. Do not install the MA/MAC6700 directly above a heat generating component such as a high powered amplifier. If all the components are installed in a single cabinet, a quiet running ventilation fan can be a definite asset in maintaining all the system components at the coolest possible operating temperature.

A custom cabinet installation should provide the following minimum spacing dimensions for cool operation.

Allow at least 6 inches (15.24cm) above the top, 2 inches (5.08cm) below the bottom and 2 inch (5.1cm) on each side of the Integrated Amplifier, so that air-flow is not obstructed. Allow 20 inches (50.8cm) depth behind the front panel. Allow 1-7/6 inch (3.66cm) in front of the mounting panel for knob clearance. Be sure to cut out a ventilation hole in the mounting shelf according to the dimensions in the drawing.

**MA/MAC6700 Front Panel
Custom Cabinet Cutout**

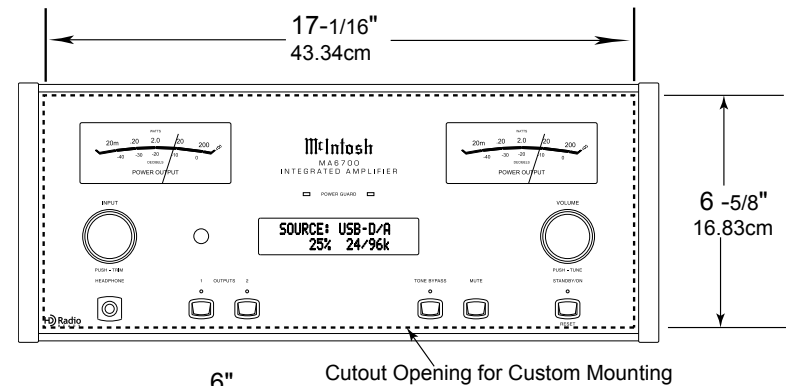

**MA/MAC6700 Side View
in Custom Cabinet**

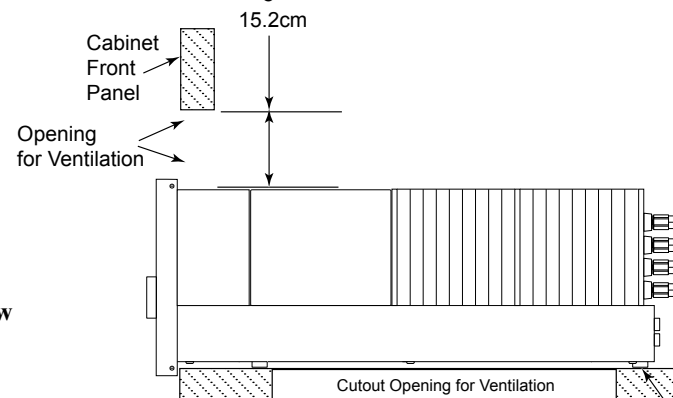

**MA/MAC6700 Bottom View
in Custom Cabinet**

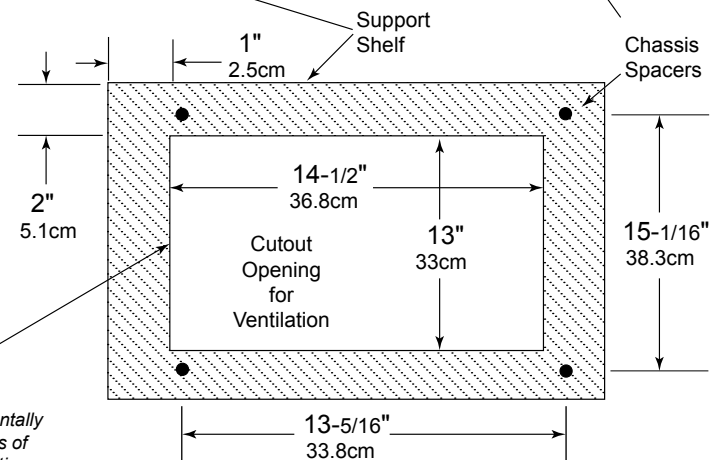

Note: Center the cutout Horizontally on the unit. For purposes of clarity, the above illustration is not drawn to scale.



Rear Panel Connections

The identification of Rear Panel Connections for the MA6700 Integrated Amplifier and MAC6700 Receiver are located on a separate folded sheet contained in the Owner's Manual Packet.

Refer to separate sheet "McIA" for the Rear Panel Connections and the next page for information on McIntosh Tuner Modules for the MA/MAC6700 .

MA6700 Integrated Amplifier and MAC6700 Receiver Rear Panel

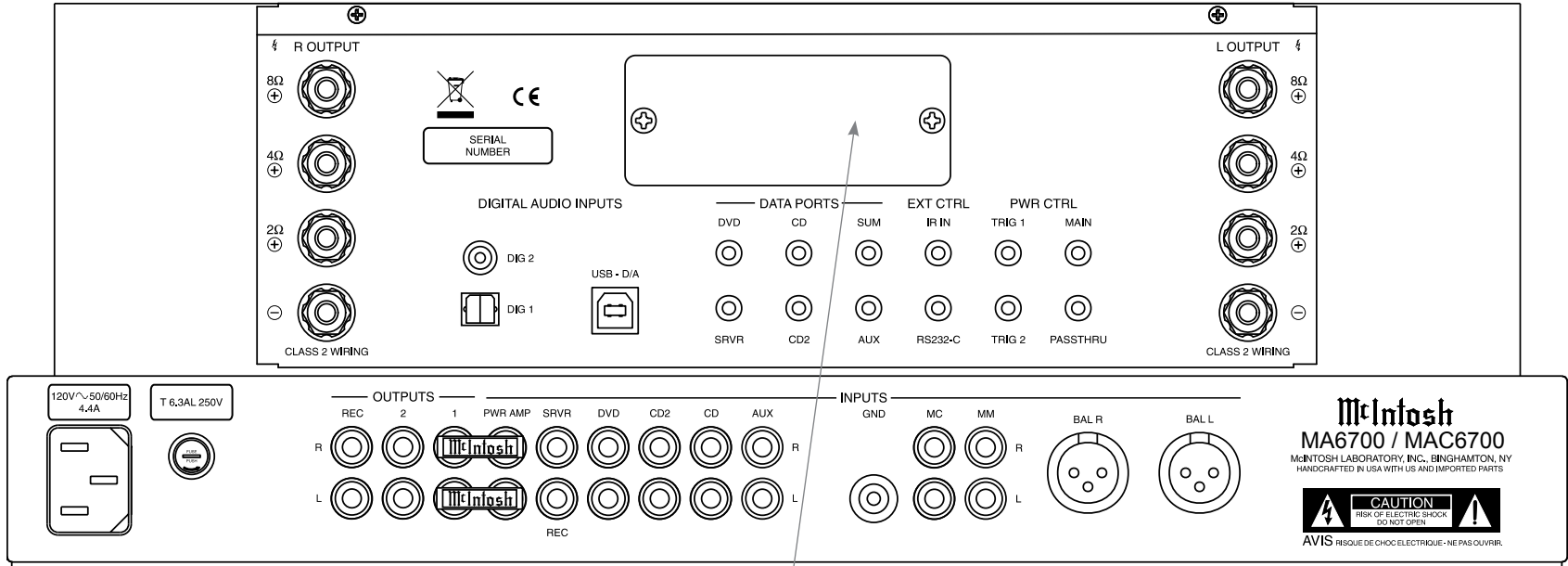

Reserved for the installation of optional Tuner Module for the MA6700. A Tuner Module is factory installed in the MAC6700.

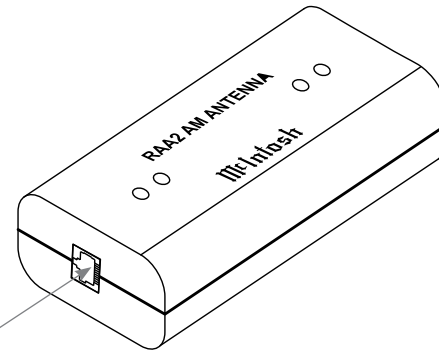

AM ANT (Antenna) connector
to a McIntosh Tuner Module

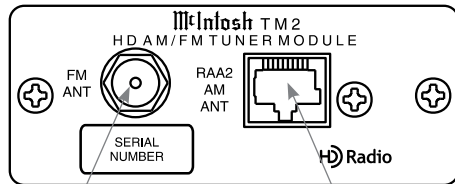

Connection for external FM Antenna

Connection for McIntosh RAA2 AM external antenna

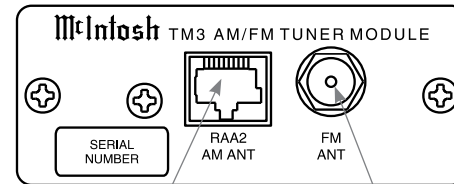

Connection for external FM Antenna

Connecting Components

The MA/MAC6700 has the ability to automatically switch power On/Off to McIntosh Source Components via the Power Control (Trigger) connections. The Data Port Connections allow for the remote operation of basic functions using the MA/MAC6700 Remote Control. With an external sensor connected to the MA/MAC6700, remote control operation of the system is possible from another room and/or when the MA/MAC6700 is located in a cabinet with the doors closed.

If the optional Tuner Module is to be installed into the MA6700 (the MAC6700 Tuner Module is factory installed) please proceed at this time to the installation procedure located on the separate folded sheet “**Mc1B**”.

The connection instructions below, together with the MA/MAC6700 Input and Output Connection Diagrams located on the separate folded sheet “**Mc2A/2B**”, are an example of a typical audio system. Your system may vary from this, however the actual components would be connected in a similar manner. For additional information refer to “Connector and Cable Information” on page 5.

Note: Source components may be connected to the MA/MAC6700 Balanced Inputs or Digital Inputs instead of Unbalanced Inputs. Refer to Setup “Reassigning Inputs” to activate them on page 22.

Power Control Connections:

1. Connect a Control Cable from the MA/MAC6700 PWR CTRL (Power Control) MAIN Jack to the Power Control In on the Turntable.
2. Connect a Control Cable from the McIntosh Turntable Power Control Out Jack to the Audio/Video Player Power Control In Jack.

3. Connect a Control Cable from the Audio/Video Player Power Control Out Jack to the SACD/CD Player Power Control In Jack.
4. Optionally connect a Control Cable from the MA/MAC6700 PWR CTRL (Power Control) TRIG (Trigger) 2 Jack to the Power Amplifier (Secondary Room) Power Control In Jack.

Note: The default setting for the TRIG 2 Jack is “MAIN”. Refer to Setup “Power Control Triggers 1 and 2” on page 24 to change TRIG 2 setting to “OUTPUT 2”.

5. Connect any additional McIntosh Components in a similar manner, as outlined in steps 1 thru 3.

Data Control Connections:

6. Connect a Control Cable from the MA/MAC6700 CD DATA PORT Jack to the SACD/CD Player Data In Jack.
7. Connect a Control Cable from the MA/MAC6700 DVD DATA PORT Jack to the Audio/Video Player Data In Jack.
8. Connect any additional McIntosh Components in a similar manner, as outlined in steps 6 thru 7.

Sensor Connection:

9. Optionally, connect the cable with stereo mini plug coming from the compatible External Sensor to the EXT CTRL (External Control) IR IN Jack on the MA/MAC6700. Refer to page 5 “General Information, note 7” for additional information.

Audio Connections:

10. Connect Balanced Cables from the MA/MAC6700 BAL (Balanced) L & R Connectors to the SACD/CD Player Fixed Audio Output Balanced Connectors.
11. Connect Audio Cables from the MA/MAC6700 DVD INPUT Jacks to the Audio/Video Player Output Jacks.

12. Connect the Audio Cables coming from the Turntable to the MA/MAC6700 MC (for a Moving Coil Cartridge) or MM (for a Moving Magnet Cartridge) INPUT Jacks.
13. Optionally, connect Audio Cables from the MA/MAC6700 OUTPUT 2 Jacks to the Power Amplifier (Secondary) Input Jacks.
14. Connect any additional Components in a similar manner, as outlined in steps 10 thru 13.

Optional Digital Audio Connections:

15. Connect a Coaxial Cable from the MA/MAC6700 DIG (Digital) 1 Digital Audio Input Jack to the Digital Out Coaxial Jack on the Audio/Video Player.
16. Connect an Optical Cable from the MA/MAC6700 DIG (Digital) 2 Digital Audio Input connector to the Digital Audio Out Optical Connector on the SACD/CD Player.

Optional USB Connection:

17. Connect a USB cable with (type A to type B) connectors from the MA/MAC6700 USB D/A Digital Audio Input to an available USB connector.

Ground Connections:

18. Connect the Ground Cable coming from the Turntable to the MA/MAC6700 GND Binding Post.

Notes: 1. If the MA/MAC6700 is part of a Home Theater System, proceed to “PassThru” connection on page 13.

2. When the MA/MAC6700 will used together with a separate Power Amplifier for Bi-Amplification of a Loudspeaker System, proceed page 16.

Passthru Connections

The MA/MAC6700 can be part of a Multichannel Sound System for SACD, DVD-Audio and Home Theater. The Right and Left Front Channels from an Audio/Video Control Center can “Passthru” the MA/MAC6700. In the following example the SRVR Input will become the “Passthru” input:

1. Connect Audio Cables from the A/V Control Center Front Left and Right Channel Outputs to the MA/MAC6700 SRVR Input Left and Right Jacks.
 2. Connect a Control Cable from the A/V Control Center ZA (Zone A) PC (Power Control) Output to the MA/MAC6700 PWR CTRL (Power Control) PASSTHRU Input Jack.
- Note: Refer to Setup “Passthru” on page 24 to assign the SRVR Input as the “Passthru” Input.*
3. Proceed to “Connecting Loudspeaker” on Page 14.

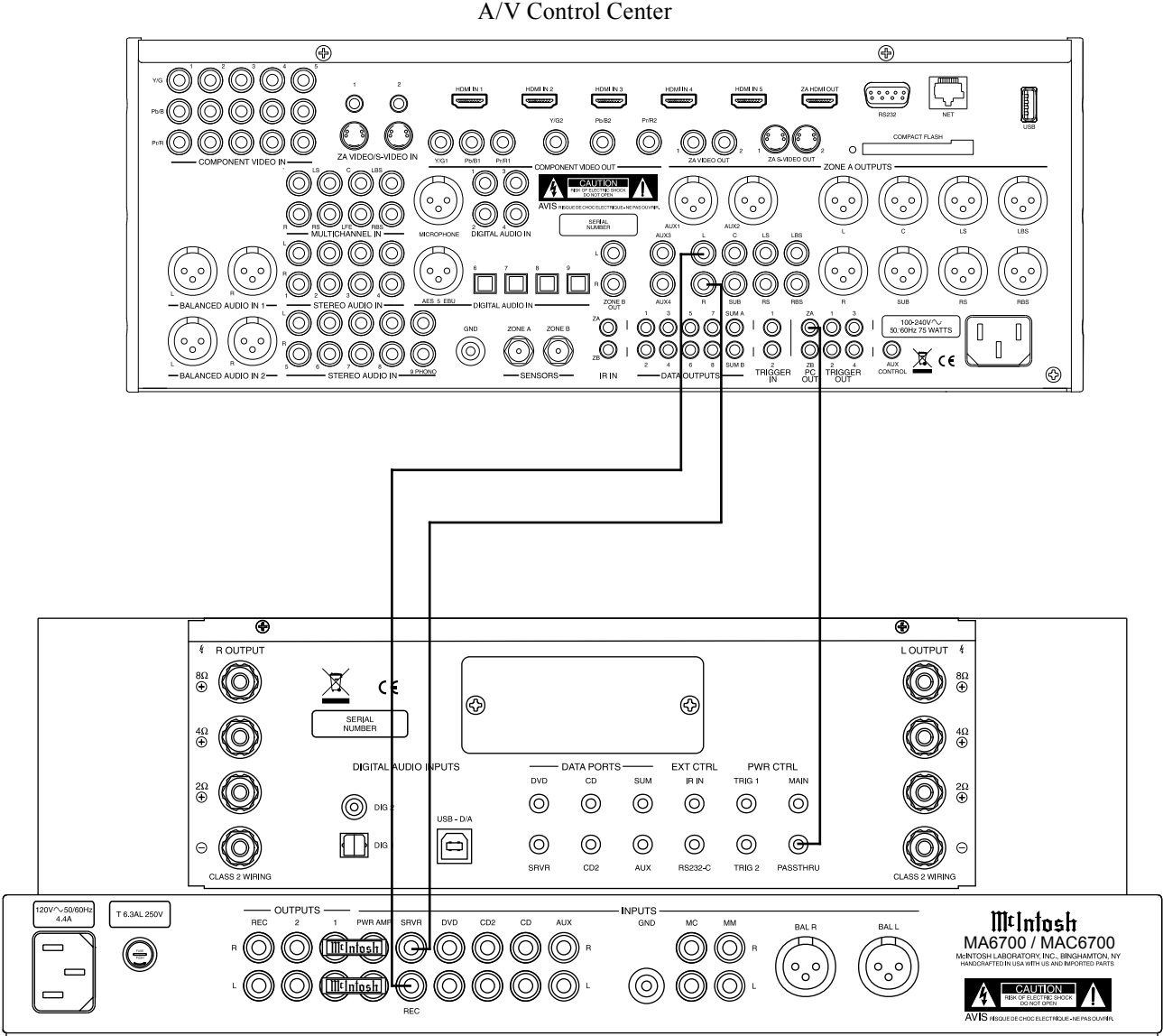

Output Terminals

When connecting the Loudspeaker Hookup Cables to the MA/MAC6700 Amplifier Output Terminals please follow the steps below:

1. Rotate the top of the Output Terminal Post counterclockwise until an opening appears. Refer to figures A and B.
2. Insert the Loudspeaker hookup cable into the Output Terminal Post opening or the cable spade lug around the center post of the Output Terminal. Refer to figure C.
3. Rotate the top of the Output Terminal Post clockwise until it is finger tight. Refer to figure D.
4. Place the supplied McIntosh Wrench over the top of the Output Terminal and rotate it one quarter of a turn (90°) to secure the Loudspeaker Cable Connection. **Do not over tighten.** Refer to figure E.

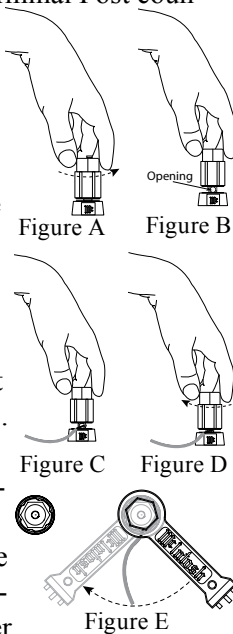

How to Connect Loudspeakers

Caution: Do not connect the AC Power Cord to the MA/MAC6700 Rear Panel until after the Loudspeaker Connections are made. Failure to observe this could result in Electric Shock.

The connection instructions below, together with the MA/MAC6700 Connection Diagram located on the separate folded sheet “Mc2B”, is an example of a typical audio system. Your system may vary from this, however the actual components would be connected in a similar manner. For additional information refer to “Connector and Cable Information” on page 5.

The McIntosh MA/MAC6700 Power Amplifier Circuitry is designed for Loudspeakers with an impedance of 2 ohms, 4 ohms or 8 ohms. Connect a single Loudspeaker only to the Right and Left Output Terminals.

When connecting Loudspeakers to the MA/MAC6700 it is very important to use cables of adequate size, so there is little to no power loss in the cables. The size is specified in Gauge Numbers or AWG (American Wire Gauge). The smaller the Gauge number, the larger the wire size:

Loudspeaker Cable Distance vs Wire Gauge Guide			
Loudspeaker Impedance	25 feet (7.62 meters) or less	50 feet (15.24 meters) or less	100 feet (30.48 meters) or less
2 Ohms	12AWG	10AWG	8AWG
4 Ohms	14AWG	12AWG	10AWG
8 Ohms	16AWG	14AWG	12AWG

1. Prepare the Loudspeaker Hookup Cable for attachment to the MA/MAC6700 Power Amplifier:
Bare wire cable ends:
Carefully remove sufficient insulation from the cable ends, refer to figures F, G & H. If the cable is stranded, carefully twist the strands together as tightly as possible.

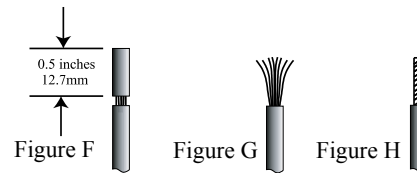

- Notes:
1. If desired, the twisted ends can be tinned with solder to keep the strands together.
 2. The prepared bare wire cable ends may be inserted into spade lug connectors.
 3. Banana plugs are for use in the United States and Canada only.

Banana Plugs are for use in the United States and Canada only:

2. Attach the previously prepared bare wire cable ends into the banana plugs and secure the connections. Refer to figure I.
3. Rotate the Output Terminal Post clockwise until it is finger tight. Refer to figure J. Then using the McIntosh Wrench, rotate the top of the Output Terminal one quarter of a turn (90°). **Do not over tighten.** Refer to figure E.
4. Referring to figure K, connect the Loudspeaker hookup cables with banana plugs into the hole at the top of the terminal to the MA/MAC6700 Negative Output Terminal and Positive Output Terminal identified as 2Ω (ohms), 4Ω (ohms) or 8Ω (ohms) connection to match the impedance of the Loudspeaker, being careful to observe the correct polarities.

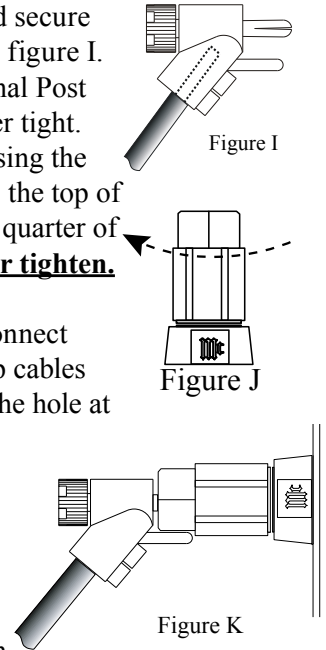

Note: The illustration located on the separate folded sheet “Mc2B” is for connection to an 8Ω (ohms) Loudspeaker.

If the Loudspeaker’s impedance is in-between the available connections, use the nearest lower impedance connection. Refer to “General Information” Note 7 on page 4 for additional information.

WARNING: Loudspeaker terminals are hazardous live and present a risk of electric shock. For additional instruction on making Loudspeaker Connections contact your McIntosh Dealer or McIntosh Technical Support.

5. Connect the MA/MAC6700 power cord to an active AC outlet.

Spade Lug or Wire Connections:

6. Connect the Loudspeaker hookup cables to the MA/MAC6700 Negative Output Terminal and Positive Output Terminal indentified as 2Ω (ohms), 4Ω (ohms) or 8Ω (ohms) connection to match the impedance of the Loudspeaker, being careful to observe the correct polarities. Insert the spade lug connector or prepared section of the cable end into the terminal side access hole, and tighten the terminal cap until the cable is firmly clamped into the terminals so the lugs or wire cannot slip out. Refer to figures L and M.

Note: The illustration located on the separate folded sheet "Mc2B" is for connection to an 8Ω (ohms) Loudspeaker.

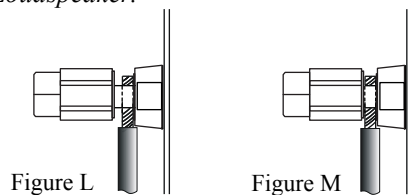

If the Loudspeaker's impedance is in-between the available connections, use the nearest lower impedance connection. Refer to "General Information" Note 7 on page 4 for additional information.

WARNING: Loudspeaker terminals are hazardous live and present a risk of electric shock. For additional instruction on making Loudspeaker Connections contact your McIntosh Dealer or McIntosh Technical Support.

7. Connect the MA/MAC6700 power cord to an active AC outlet.

Connecting for Bi-Amplification

The MA/MAC6700's Power Amplifier, together with an additional separate Power Amplifier, may be used to Bi-Amplify a Loudspeaker System. In the illustration on this page the Power Amplifier of the MA/MAC6700 is connected to the Midrange/High Frequency Section of the Loudspeaker. The additional separate Power Amplifier is connected to the Low Frequency Section of the Loudspeaker System.

Warning: *The Loudspeaker System used for Bi-Amplification must have the jumpers removed from between the MID/HIGH and LOW Frequency Sections of the Loudspeaker System. Failure to remove them could result in damage to the MA/MAC6700 and/or the separate Power Amplifier.*

MA/MAC6700 Connections:

1. Remove the "McIntosh Jumpers" from between the OUTPUT 1 Jacks and the PWR AMP In Jacks located on the Rear Panel of the MA/MAC6700.

Note: Place the "McIntosh Jumper" in a safe place for possible future use.

2. Using a pair of shielded RCA Type Audio "Y" Adapters connect the OUTPUT 1 Jacks to the PWR AMP In Jacks, for both Left and Right Channels.
3. Connect the remaining unconnected part of the "Y" Adapters to the separate Power Amplifier.
4. Referring to the Loudspeaker Connection Instructions on page 14, and in the Owner's Manual supplied with the Power Amplifier and Loudspeaker, connect the MA/MAC6700 Output Terminals to the Loudspeaker MID/HIGH Input Terminals.

Note: The Loudspeaker Connection illustrations on this page are for the Left Channel. Connect the Right Channel Loudspeaker in the same manner.

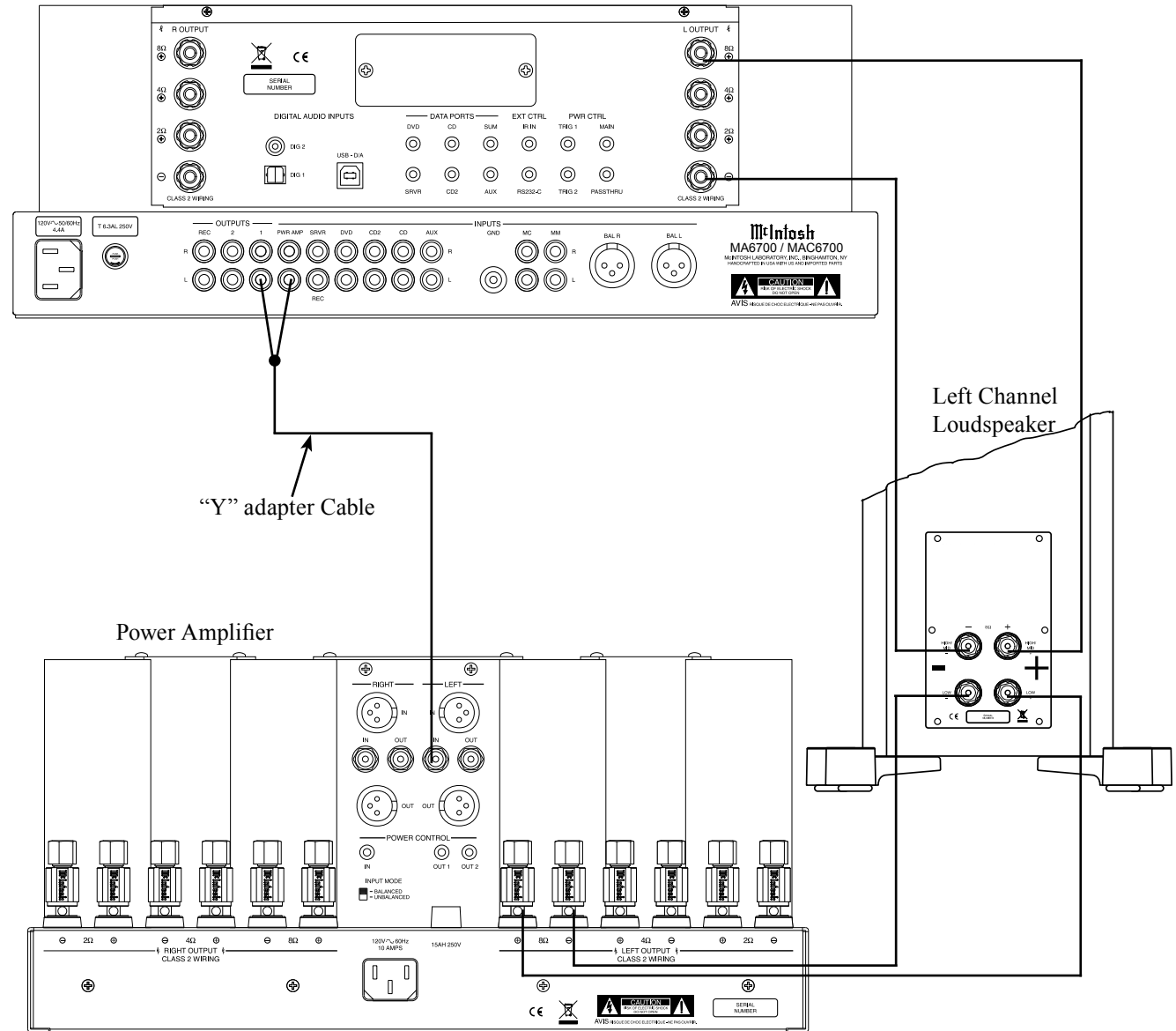





LED illuminates during the time a remote command is sent to the MA/MAC6700

Switches the Trigger 1 and/or 2 Power Control Jack(s) On/Off, refer to "Setup, Power Control TRIG 1 and TRIG 2" on page 24 for additional information

Selects a Disc Player, Music Server or Recorder Function. Seek Stations Up or Down the AM/FM Dial. Select and/or enter AM/FM Station Presets and performs various functions on a variety of McIntosh Components

Used to tune Up or Down the AM/FM Dial

Displays On Screen Functions on the McIntosh Music Server and a variety of other McIntosh Components

Adjusts the volume level up or down

Activates the TRIM Stereo/Mono Mode

Mutes the audio

Selects AM Tuner Operating Functions and Disc Selection on certain McIntosh Disc Players

Selects Functions as a "shift" key when used with the AM or FM push-buttons to select Output 1 or 2

Scrolls through the available MA/MAC6700 Inputs

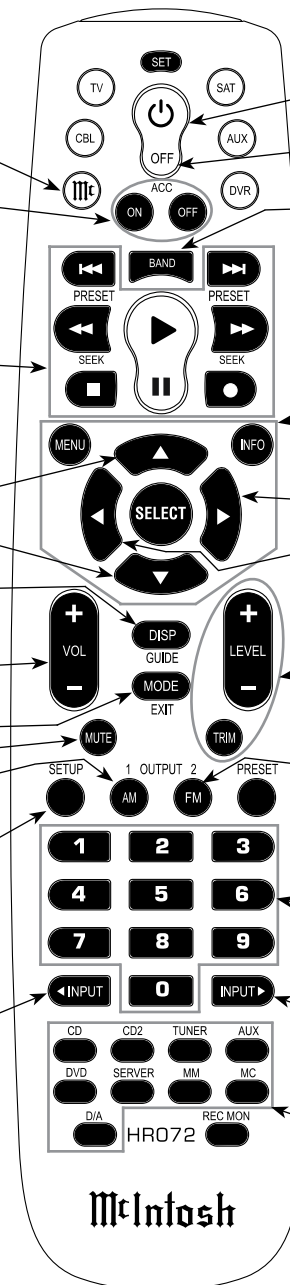

Press to Power the MA/MAC6700 ON

Press to Power the MA/MAC6700 OFF

Press to change broadcast bands on an external McIntosh Tuner connected. Select certain functions on a variety of McIntosh Components

Selects On Screen Functions on a variety of McIntosh Components

Press to step Up or Down the AM/FM Dial for the next HD Radio Program (TM2 Tuner Module installed)

Press TRIM and then the LEVEL Push-buttons to select and adjust various functions

Selects FM Tuner Operating Functions and Track Selection on certain McIntosh CD Players

Use to select tuner presets, direct access an AM/FM Station Frequency, disc tracks or any numbered operation

Scrolls through the available MA/MAC6700 Inputs

Selects one of the eight available Audio Sources

Note: Push-buttons whose function is not identified above are for use with other McIntosh Products.

How to use the Remote Control

The supplied HR072 Remote Control is capable of directly controlling the functions of contemporary Source Components connected to the MA/MAC6700 via the Data Ports.

Notes: 1. If at any time the MA/MAC6700 seems unresponsive to HR072 Remote Control Commands press the  Push-button first.

2. For additional information on using the HR072 Remote Control with the MA/MAC6700, please refer to the "How to Operate" section of this Owner's Manual starting on page 30.

Input Source Selection

Press the appropriate Source Push-button to select the desired program source.

Note: When the MA/MAC6700 is Off, pressing one of the Source Push-buttons will switch the MA/MAC6700 On and it will go to that Input.

Mute

Press the MUTE Push-button to mute the audio in all outputs except the REC OUTPUT. The word MUTE will appear on the Front Panel Display. To un-mute the audio, press the MUTE Push-button again.

Disc, Server and Recorder Functions

Use these push-buttons to operate a DVD Player, CD Player, CD Changer, Music Server or Recorder.





Numbered Push-buttons

Press Push-buttons 0 through 9 to access tuner station presets, tracks on discs or selections on a Music Server.



Disc and Track

Use the AM (disc) and FM (track) Push-buttons when a Disc Player or Music Server is being used.

Tuner Push-buttons

Press the AM or FM Push-button to select the desired broadcast band. Press and release the Seek Up  the band or Seek Down  the band Push-button to seek the next available station. Press and hold a Directional Up  or Down  Push-button to tune continuously from station to station.

Volume



Press the VOLUME Up  or Down  Push-button to raise or lower the listening volume level.

Note: The Record Signals present at REC OUTPUTS are not affected by volume changes.

Pause

Press the Pause  Push-button to perform various functions on a variety of McIntosh Components. It will also pause the playing of a disc or tape player.

Trim

Press the TRIM Push-button until the desired Trim function (Balance, Trim Level, etc.) appears on the Front Panel Display, then press the LEVEL Up  or Down  Push-button to adjust the Trim setting.

Note: Press the TRIM Push-button to recall the last Trim function selected. For additional information on the Trim Functions refer to page 30 thru 35.

Amplifier Selection

Press the BLUE (Setup) Push-button followed by the AM (Output 1) or FM (Output 2) Push-button, to control the rear panel Audio OUTPUTS 1, 2 (ON or OFF) and Power Control TRIG 1 / TRIG 2. These OUTPUTS provide signals to the MA/MAC6700 Power Amplifier and/or other accessory component.

Note: Refer to SETUP on page 24 "Power Control Triggers 1 and 2 to change the default setting of "MAIN" to "REMOTE".



INPUT Control allows the selection of various sources for listening and recording.

TRIM allows selection of various types of audio settings. It is also used in the setup mode for various functions

LED indicates when the Left Channel Amplifier POWER GUARD circuit activates

LED indicates when the Right Channel Amplifier POWER GUARD circuit activates

VOLUME Control allows adjustment of the listening level for both channels. TUNE tunes in radio stations. It is also used in the setup mode for various functions

Meter indicates the Left Channel Output of the amplifier

INFORMATION DISPLAY indicates the Sources, Volume, other Audio Settings, Operational Functions and Setup Mode Settings

Meter indicates the Right Channel Output of the amplifier

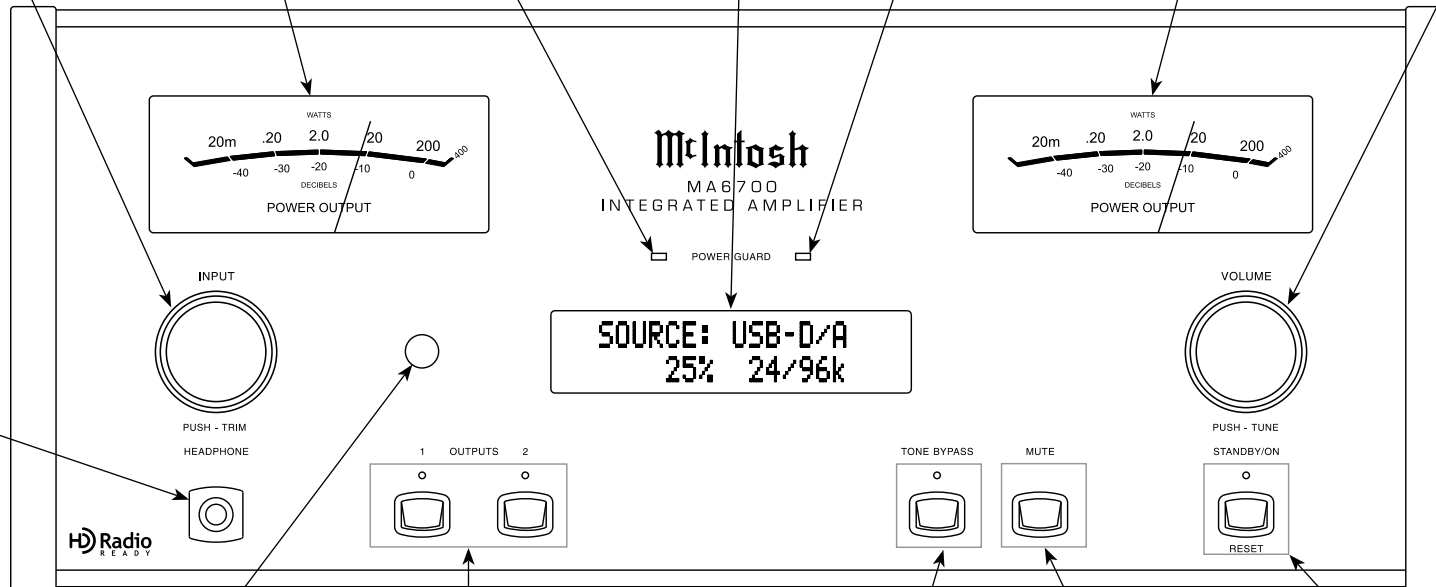

Connection for dynamic type headphones, for private listening

IR Sensor receives commands from a Remote Control

OUTPUT 1 and 2 Push-buttons with indicators, switch Preamp Output (Loudspeakers) 1 and 2 On or Off

TONE BYPASS Push-button with indicator, when activated the audio signal bypasses the Tone Controls

MUTE Push-button mutes the audio from the Loudspeakers and Headphones

STANDBY/ON Push-button with indicator switches the MA/MAC6700 ON or OFF (Standby) and resets the microprocessors

How to Operate the Setup Mode

Your McIntosh MA/MAC6700 has been factory configured for default operating settings that will allow immediate enjoyment of superb audio without the need for further adjustments. If you wish to make changes to the factory default settings, a Setup Feature is provided to customize the operating settings using the Front Panel Display. Refer to the MA/MAC6700 Front Panel Illustration on the previous page while performing an introduction into operating the Setup Mode, follow the steps below.

Note: If the MA/MAC6700 is currently On, proceed to step 2.

1. Press the STANDBY/ON Push-button on the Front Panel or press the  (Power) Push-button on the Remote Control to switch On the MA/MAC6700. The MA/MAC6700 will go through a brief startup initialization with the Front Panel Display indicating the last used source and volume setting. This is followed by the volume setting indication starting at zero and then increasing to the last used volume setting. Refer to figure 1.



Figure 1

2. Press and hold the INPUT CONTROL until the Front Panel Display indicates “MA6700 (or MAC6700) V_._, S/N: _____”. The information indicated on the Front Panel Display includes the Model Number, Firmware Version and the Serial Number for this unit; see page 22 for additional information. Refer to figure 2A for the MA6700 and Figure 2B for the MAC6700.



Figure 2A



Figure 2B

3. Now rotate the INPUT CONTROL Clockwise until the Front Panel Display indicates “McIntosh USB AUDIO, V_._ Firmware”. Refer to figure 3 and to page 21 for additional information.



Figure 3

4. Next, rotate the INPUT CONTROL Clockwise again until the Front Panel Display indicates “SETUP: SOURCE INPUT, CD :RCA” Refer to figure 4.



Figure 4

5. To exit from the Setup Mode, press the INPUT CONTROL and the Front Panel Display will revert back to its normal display. Refer to figure 1.

Default Settings

The Default Settings Chart below indicates the Function Name, Default Setting and the Page Number for additional information.

Default Settings		
Function Name	Setting	Page No.
MA6700 or MAC6700	V_._ S/N: _____	22
McIntosh USB Audio	V_._	22
SOURCE INPUT (Reassignment)	RCA	22

Default Settings		
SOURCE NAME (Re-assign Input Names)	_____>> _____ _____	23
PASSTHRU	OFF	24
TRIG 1 Output (Action)	MAIN	24
TRIG 2 Output (Action)	MAIN	24
COMM PORT (Baud Rate)	115200	25
REMOTE (Codes)	NORM	26
POWER MODE (Auto Off)	ENABLED	26
TUNER SDK ² (TM2)	MC_----- ---	27
TUNER DSP ² (TM2)	DRI-_------ ---	27
CLEAR PRESETS ² (TM2)	NONE	27
TUNER VERSION ³ (TM3)	TM3_-----	28
CLEAR PRESETS ³ (TM3)	NONE	28
TUNER REGION ³ (TM3)	USA	29

- Notes:*
1. Setup Mode operations should be performed in the order they appear in the Setup Menu as they are interactive.
 2. These Setup Adjustments Appear only when the McIntosh TM2 Tuner Module is installed in the MA6700 or MAC6700.
 3. These Setup Adjustments Appear only when the McIntosh TM3 Tuner Module is installed in the MA6700 or MAC6700.



Firmware Version

The MA/MAC6700 functionality is controlled by internal software that is known as Firmware. The MA/MAC6700 has two different Firmwares, one is the “System Firmware” (responsible for the basic operation of the MA/MAC6700) and the other known as USB Audio Firmware (responsible for the “USB Connection and Conversion” of a Digital Audio Signal from the Computer). The Version of the Firmwares in the MA/MAC6700 can be identified at any time by utilizing the Setup Mode.

1. Press and hold the INPUT CONTROL until the Front Panel Display indicates “MA6700 (or MAC6700) V_._, S/N: _____”. The number after the “V” is the firmware version and the number after the “S/N” is the serial number of the unit (or higher). Refer to figure 2A for the MA6700 and Figure 2B for the MAC6700.



Figure 2A



Figure 2B

2. The number after the character “V” is the Firmware number.
3. Rotate the INPUT CONTROL Clockwise until the Front Panel Display indicates “McIntosh USB Audio V_._”. Refer to figure 3.



Figure 3

4. To exit from the Setup Mode, press the INPUT CONTROL and the Front Panel Display will revert back to its normal display.

Source Input Reassignment

The MA/MAC6700 provides the ability to reassign High Level Inputs (non-Phono) to either the Balanced Input or one of the two Digital Inputs.

In the first example, the CD Input will be reassigned from the unbalanced CD (RCA Jacks) to the BALANCED Connectors (XRL).

Notes: 1. Any one of the Default Inputs may be switched Off. If any input is switched Off its name will no longer appear on the Front Panel Display when using the INPUT Control, nor is it accessible with the Remote Control.

2. *The Phono MC (Moving Coil) and MM (Moving Magnet) Input are designed for connection of a turntable only and thus non-reassignable. However, the Phono Inputs may be switched Off.*
3. *Only one Input may be assigned at a time to the Balanced or Digital (1 or 2) Connectors. If an already assigned Balanced or Digital connector is to be reassigned to a different Input, the Input currently assigned to the connector first needs to be changed. It can be temporarily set to Off, RCA connector, available Balanced or available Digital connector.*

1. Press and hold the INPUT CONTROL until the Front Panel Display indicates the Setup Mode is active. Then rotate the INPUT CONTROL and select the Setup Menu item “SETUP: SOURCE INPUT, CD :RCA”. Refer to figure 4.



Figure 4

2. Rotate the VOLUME Control until “SETUP: SOURCE INPUT, CD :BALANCED” appears on the Front Panel Display. Refer to figure 5.



Figure 5

The second example will illustrate reassigning the CD2 Input (connected to a SACD/CD Player) from CD2 Input (RCA Jacks) to the DIGITAL 1 Optical Input.

3. Press the VOLUME Control and the CD Input will change to the CD2 INPUT. The Front Panel Display will now indicate “SETUP: SOURCE INPUT, CD2 :RCA”. Refer to figure 6.



Figure 6

4. Rotate the VOLUME Control until “SETUP: SOURCE INPUT, CD2 :DIGITAL 1” appears on the Front Panel Display. Refer to figure 7.



Figure 7

Record any changes made to the various inputs from the default settings in the “Input and Power Control Settings” chart for future reference.

5. To exit from the Setup Mode, press the INPUT CONTROL and the Front Panel Display will revert back to its normal display.

Input and Power Control Settings				
Input Name	Connection Type	New Level (Trim)	Triggers	
			1	2
TUNER FM ¹	INTERNAL			
TUNER AM ¹	INTERNAL			
CD				
CD2				
DVD				
AUX				
SRVR (Rec)				
PHONO MC				
PHONO MM				

Note: 1. These Setup adjustments appear only when the McIntosh TM2 or TM3 Tuner Module is installed in the MA6700 or MAC6700.

Source Input Renaming

The MA/MAC6700 Default Input Names (CD, AUX, DVD, etc. as indicated on the Front Panel Display), can be customized with a different name up to nine characters long (My Phone, MCD1100, etc.). The available characters for renaming the input include the following: ! < > * , / - _ 0 1 2 3 4 5 6 7 8 9 A B C D E F G H I K L M N O P Q R S T U V W X Y Z .

In the following example, the AUX Input will be re-named to "MY-PHONE".

1. Press and hold the INPUT CONTROL until the Front Panel Display indicates the Setup Mode is active. Then rotate the INPUT CONTROL and select the Setup Menu item "SETUP: SOURCE NAME, AUX >> AUX". Refer to figure 8.



Figure 8

Note: If the AUX Input is not displayed, press the VOLUME Control repeatedly until it is displayed.

2. Press and hold the VOLUME Control until the character "A" of the name AUX starts flashing. Refer to figure 9.



Figure 9

3. Rotate the VOLUME Control until the character "M" appears. Refer to figure 10.



Figure 10

4. Press the the VOLUME Control until the character "U" starts flashing. Refer to figure 11.



Figure 11

5. Rotate the VOLUME Control until the character "Y" appears. Refer to figure 12.



Figure 12

6. Repeat steps 3 thru 5 until the new name of "MY-PHONE" is indicated on the Front Panel Display. Refer to figure 13.



Figure 13

7. To save the new Input Name press and hold the VOLUME Control until the word SAVED appears momentarily on the Front Panel Display. Refer to figure 14.



Figure 14

Note: When direct accessing the "MY-PHONE" Input using the Remote Control, press the AUX Pushbutton.

Record any changes made to the various default Input Names in the following chart for future reference.

8. To exit from the Setup Mode, press the INPUT CONTROL and the Front Panel Display will revert back to its normal display.

Source Input Renaming	
Default Input Name	New Input Name
TUNER FM ¹	
TUNER AM ¹	
CD	
CD2	
DVD	
AUX	
SRVR (Rec)	
PHONO MC	
PHONO MM	



Passthru

The MA/MAC6700 can be part of a Multichannel Sound System for SACD, DVD-Audio and Home Theater. The Right and Left Front Channels from an Audio/Video Control Center or Surround Decoder can “Passthru” the Preamplifier Circuitry of the MA/MAC6700, and then on to the Power Amplifier Circuitry of the MA/MAC6700. The Setup Mode allows the activation of the Passthru Mode and the selection of the specified MA/MAC6700 Input Source. In the example below, the Right and Left Front Channels from the Audio/Video Control Center will be connected to the SRVR (Server) Input Jacks on the MA/MAC6700. Refer to page 13 for additional connection information.

Notes: 1. The Phono Input Connectors and Digital Input Connectors are not assignable as a Passthru Input.

2. If the Balanced Input Connectors are already reassigned to a given Input, they will not appear in the list of available Inputs for the Passthru Mode.

3. When one of the RCA Inputs is selected as a Passthru Input, it is advisable to remove it from the list of available Inputs by switching it Off. Refer to “Source Inputs Reassignment” starting on page 22.

1. Press and hold the INPUT CONTROL until the Front Panel Display indicates the Setup Mode is active. Then rotate the INPUT CONTROL and select the Setup Menu item “SETUP: PASSTHRU, Source: OFF”. Refer to figure 15.

```

SETUP: PASSTHRU
Source: OFF
  
```

Figure 15

2. Rotate the VOLUME Control until “SETUP: PASSTHRU, Source: SRVR<RCA>” appears on the

Front Panel Alphanumeric Display. Refer to figure 16.

```

SETUP: PASSTHRU
Source: SRVR<RCA>
  
```

Figure 16

3. To exit from the Setup Mode, press the INPUT CONTROL and the Front Panel Display will revert back to its normal display.

Power Control Triggers 1 and 2

By default the Power Control TRIGGER 1 and TRIGGER 2 Outputs function the same as the MAIN Power Control Jack, switching On/Off with the MA/MAC6700. Trigger 1 and 2 are also reassignable to activate when the ACC ON/OFF Push-buttons on the Remote Control are used, when a given Input (or Inputs) is selected or when the Front Panel (or Remote Control) OUTPUT 1 or OUTPUT 2 Push-buttons are pressed.

EXAMPLE ONE:

The Power Control Trigger 1 Output will be set to function via the Remote Control ACC Push-buttons.

1. Press and hold the INPUT CONTROL until the Front Panel Display indicates the Setup Mode is active. Then rotate the INPUT CONTROL until the Setup Menu item “SETUP: TRIG1 OUTPUT, Action: MAIN” appears on the Front Panel Display. Refer to figure 17.

```

SETUP: TRIG1 OUTPUT
Action: MAIN
  
```

Figure 17

2. Rotate the VOLUME Control until “SETUP: TRIG1 OUTPUT, Action: REMOTE” appears. Refer to figure 18.

```

SETUP: TRIG1 OUTPUT
Action: REMOTE
  
```

Figure 18

3. To exit from the Setup Mode, press the INPUT CONTROL and the Front Panel Display will revert back to its normal display.

EXAMPLE TWO:

This example will use selection of the Tuner FM Input to switch the Trigger 1 Output On.

4. Press and hold the INPUT CONTROL until the Front Panel Display indicates the Setup Mode is active. Then rotate the INPUT CONTROL until the Setup Menu item “SETUP: TRIG1 OUTPUT, Action: MAIN” appears on the Front Panel Display. Refer to figure 17.
5. Rotate the VOLUME Control until “SETUP: TRIG1 OUTPUT, Action: SOURCE” appears. Refer to figure 20.

```

SETUP: TRIG1 OUTPUT
Action: SOURCE
  
```

Figure 20

6. Rotate the INPUT Control until the first Source Input Menu item “SETUP: TRIG1 OUTPUT, Source: _____ OFF” appears on the Front Panel Display. Refer to figure 21.

```

SETUP: TRIG1 OUTPUT
Source: AUX      OFF
  
```

Figure 21

Notes: 1. By default all the Source Inputs are set to Off.

2. Any combination of Source Inputs from one to all may be assigned to either Trigger (1 or 2) or both Triggers.

7. Press the VOLUME Control repeatedly until the Source Input Menu item “SETUP: TRIG1 OUTPUT, Source: TUNER FM OFF” appears on the Front Panel Display. Refer to figure 22.

```

SETUP: TRIG1 OUTPUT
Source: Tuner FM OFF
  
```

Figure 22

8. Rotate the VOLUME Control until “SETUP: TRIG1 OUTPUT, Source: TUNER FM ON” appears. Refer to figure 23.

```

SETUP: TRIG1 OUTPUT
Source: Tuner FM ON
  
```

Figure 23

9. To exit from the Setup Mode, press the INPUT CONTROL and the Front Panel Display will revert back to its normal display.

EXAMPLE THREE:

The Trigger 1 and Trigger 2 Outputs will be assigned to the OUTPUT 1 or OUTPUT 2 Push-buttons.

10. Press and hold the INPUT CONTROL until the Front Panel Display indicates the Setup Mode is active. Then rotate the INPUT CONTROL until the Setup Menu item “SETUP: TRIG1 OUTPUT, Action: MAIN” appears on the Front Panel Display. Refer to figure 17.
11. Rotate the VOLUME Control until “SETUP: TRIG1 OUTPUT, Action: OUT 1” appears. Refer to figure 24.

```

SETUP: TRIG1 OUTPUT
Action: OUT 1
  
```

Figure 24

12. Rotate the INPUT CONTROL until the Setup Menu item “SETUP: TRIG2 OUTPUT, Action: MAIN” appears on the Front Panel Display. Refer to figure 25.

```

SETUP: TRIG2 OUTPUT
Action: MAIN
  
```

Figure 25

13. Rotate the VOLUME Control until “SETUP: TRIG2 OUTPUT, Action: OUT 2 ” appears. Refer to figure 26.

```

SETUP: TRIG2 OUTPUT
Action: OUT 2
  
```

Figure 26

Record any changes made to the various inputs from the default settings in the “Input and Power Control Settings” chart on page 22-23 for future reference.

14. To exit from the Setup Mode, press the INPUT CONTROL and the Front Panel Display will revert back to its normal display.

Comm Port Baud Rate

The MA/MAC6700 may be remotely controlled from other equipment connected to the Rear Panel RS232C Jack. The speed at which the MA/MAC6700 communicates (8 bit, no parity and 1 stop bit) with other equipment is adjustable from 9,600 bits per second to 115,200 bits per second. To change from the default speed of 115,200 bits per second, perform the following steps:

1. Press and hold the INPUT CONTROL until the Front Panel Display indicates the Setup Mode is active. Then rotate the INPUT CONTROL until the Setup Menu item “SETUP: COMM PORT, BAUD RATE: 115200” appears on the Front Panel Display. Refer to figure 27.

```

SETUP: COMM PORT
BAUD RATE: 115200
  
```

Figure 27

2. Rotate the VOLUME Control to select the desired speed.
3. To exit from the Setup Mode, press the INPUT CONTROL and the Front Panel Display will revert back to its normal display.



Remote Control Codes

The Remote Control included with the MA/MAC6700 utilizes the NORMal McIntosh Control Codes. The Second Set of Control Codes the MA/MAC6700 will respond to is referred to as the ALternate Codes.

When the MA/MAC6700 is used in the same location as another McIntosh Preamplifier and/or A/V Control Center, the ALternate Codes are used. This will prevent the Remote Control from affecting the operation of both units at the same time. To activate the Remote Control ALternate Codes perform the following steps:

1. Press and hold the INPUT CONTROL until the Front Panel Display indicates the Setup Mode is active. Then rotate the INPUT CONTROL until the Setup Menu item “SETUP: REMOTE, CODES: NORM” appears on the Front Panel Display. Refer to figure 27.



SETUP: REMOTE
CODES: NORM

Figure 27

2. Rotate the VOLUME Control to select “SETUP: REMOTE, CODES: ALT”. Refer to figure 28



SETUP: REMOTE
CODES: ALT

Figure 28

3. To exit from the Setup Mode, press the INPUT CONTROL and the Front Panel Display will revert back to its normal display.
4. To change the MA/MAC6700 Remote Control to the Alternate Codes perform the following steps:
 - A. Press the “Mc” Push-button.
 - B. Press the SET Push-button until the “Mc” Push-button flashes twice.
 - C. Press the 3, 2, 4, 2 and 9 Push-buttons within 5 seconds.
 - D. The “Mc” Push-button flashes twice.

Note: To reset the Remote Control to normal codes perform steps A and B then enter 3, 2, 4, 2 and 8 for step C.

5. Press the VOLUME UP/DOWN Push-button on the Remote Control to verify proper operation.

Power Mode

The MA/MAC6700 incorporates an Auto Off Feature, which automatically places the preamplifier into the Power Saving Standby/Off Mode. This occurs approximately 30 minutes after there has been an absence of audible audio signals on the selected input (on either channel) or user activity (includes changes to any of the Operation Functions such as source selection, volume adjustment, etc). If it is desirable to disable the Auto Off Feature perform the following steps:

1. Press and hold the INPUT CONTROL until the Front Panel Display indicates the Setup Mode is active. Then rotate the INPUT CONTROL until the Setup Menu item “SETUP: POWER MODE, Auto Off: Enabled” appears on the Front Panel Display. Refer to figure 29.



SETUP: POWER MODE
Auto Off: Enabled

Figure 29

2. Rotate the VOLUME Control until “SETUP: POWER MODE, Auto Off: Disabled” appears on the Front Panel Display. Refer to figure 30.



SETUP: POWER MODE
Auto Off: Disabled

Figure 30

3. To exit from the Setup Mode, press the INPUT CONTROL and the Front Panel Display will revert back to its normal display.

TM2 Tuner Module Firmware Version

Your McIntosh MA/MAC6700 with the TM2 Tuner Module installed has been factory configured for default operating settings that will allow immediate enjoyment of superb audio from AM/FM and HD Radio™ Stations without the need for further adjustments. Proceed to “Operating the TM2 and TM3 Tuner Module” on page 39 at this time, unless you wish to make changes to the TM2 factory default settings.

1. Press and hold the INPUT CONTROL until the Front Panel Display indicates the Setup Mode is active. Then rotate the INPUT CONTROL until the Setup Menu item “SETUP: TUNER SDK, MC____.____” firmware version. Refer to figure TM2-1.



Figure TM2-1

2. Rotate the INPUT Control until the Front Panel Display indicates “SETUP: TUNER DSP, DRI-____-____-____” firmware version. Refer to figure TM2-2.

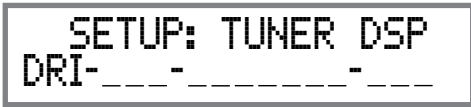

Figure TM2-2

These firmware version numbers identify the type of operation functions of the TM2 Tuner Model.

3. To exit from the Setup Mode, press the INPUT CONTROL and the Front Panel Display will revert back to its normal display.

TM2 Tuner Module Clear Presets

The TM2 AM/FM Tuner has three different Tuning Modes when installed into the MA/MAC6700. One of the Tuning Modes is Preset Tuning, where favorite stations are entered into memory for quick recall. Any preset station may be removed from memory at any time. There are times when it may be desirable to remove from memory all the preset stations. To accomplish this perform the following steps:

1. Press and hold the INPUT CONTROL until the Front Panel Display indicates the Setup Mode is active. Then rotate the INPUT CONTROL until the Setup Menu item “SETUP: TUNER, Clear Presets: None” is indicated. Refer to figure TM2-3.



Figure TM2-3

2. Rotate the VOLUME Control to select one of four choices. Refer to figures TM2-4 thru TM2-6.
 - NONE (default setting, No Presets are cleared)
 - AM (all AM stored Presets are cleared)
 - FM (all FM stored Presets are cleared)
 - All (all AM and FM stored Presets are cleared)



Figure TM2-4



Figure TM2-5



Figure TM2-6

3. After the “Clear Presets” choice has been selected (None, AM, FM or ALL), the change to the stored presets will occur when the SETUP Mode has been exited in the next step.
4. To exit from the Setup Mode, press the INPUT CONTROL and the Front Panel Display will revert back to its normal display.



TM3 Tuner Module Firmware Version

Your McIntosh MA/MAC6700 with the TM3 Tuner Module installed has been factory configured for default operating settings that will allow immediate enjoyment of superb audio from AM and FM Stations without the need for further adjustments. Proceed to “Operating the TM2 and TM3 Tuner Module” on page 39 at this time, unless you wish to make changes to the TM3 factory default settings.

1. Press and hold the INPUT CONTROL until the Front Panel Display indicates the Setup Mode is active. Then rotate the INPUT CONTROL until the Setup Menu item “SETUP: TUNER VER, TM3_____” firmware version. Refer to figure TM3-1.



Figure TM3-1

The firmware version number identifies the type of operation function of the TM3 Tuner Model.

2. To exit from the Setup Mode, press the INPUT CONTROL and the Front Panel Display will revert back to its normal display.

TM3 Tuner Module Clear Presets

The TM3 AM/FM Tuner has three different Tuning Modes when installed into the MA/MAC6700. One of the Tuning Modes is Preset Tuning, where favorite stations are entered into memory for quick recall. Any preset station may be removed from memory at any time. There are times when it may be desirable to remove from memory all the preset stations. To accomplish this perform the following steps:

1. Press and hold the INPUT CONTROL until the Front Panel Display indicates the Setup Mode is active. Then rotate the INPUT CONTROL until the Setup Menu item “SETUP: TUNER, Clear Presets: None” is indicated. Refer to figure TM3-2.



Figure TM3-2

2. Rotate the VOLUME Control to select one of four choices. Refer to figures TM3-3 thru TM3-5.
 - NONE (default setting, No Presets are cleared)
 - AM (all AM stored Presets are cleared)
 - FM (all FM stored Presets are cleared)
 - All (all AM and FM stored Presets are cleared)



Figure TM3-3



Figure TM3-4



Figure TM3-5

3. After the “Clear Presets” choice has been selected (None, AM, FM or ALL), the change to the stored presets will occur when the SETUP Mode has been exited in the next step.
4. To exit from the Setup Mode, press the INPUT CONTROL and the Front Panel Display will revert back to its normal display.

TM3 Tuner Regions

The TM3 Tuner is capable of receiving AM/FM Broadcasts in various parts of the world. In some countries the broadcasters use slightly different standards and the TM3 accommodates these differences.

The Tuner Region Default Setting is for the USA. To change the TM3 for the broadcast standards in your country follow the steps below for changing the receiving standards:

Note: Changing the current Tuner Region will result in clearing of all the Station Presets.

1. Press and hold the INPUT CONTROL until the Front Panel Display indicates the Setup Mode is active. Then rotate the INPUT CONTROL until the Setup Menu item "SETUP: TUNER, Region: USA" is indicated. Refer to figure TM3-8.
2. Rotate the VOLUME Control to select the correct Region. Refer to figures TM3-6 thru TM3-9.



Figure TM3-6



Figure TM3-7

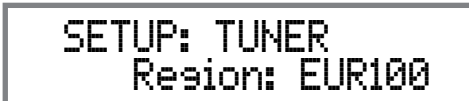

Figure TM3-8

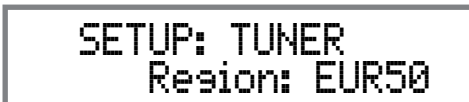

Figure TM3-9

Setting	AM Band	FM Band	FM Spacing
USA	530kHz - 1710kHz	87.9MHz - 107.9MHz	200kHz
JAPAN	522kHz - 1611kHz	76MHz - 90MHz	100kHz
EUR 100	522kHz - 1602kHz	87.5MHz - 108MHz	100kHz
EUR 50	522kHz - 1602kHz	87.5MHz - 108MHz	50kHz

Note: For additional information contact your McIntosh Dealer.

3. To exit from the Setup Mode, press the INPUT CONTROL and the Front Panel Display will revert back to its normal display.





How to Operate the MA/MAC6700

Power On and Off

The Red LED above the STANDBY/ON Push-button lights to indicate the MA/MAC6700 is in Standby mode. To switch ON the MA/MAC6700, Press the STANDBY/ON Push-button on the Front Panel or press the (Power) Push-button on the Remote Control. The MA/MAC6700 will go through a brief startup initialization with the Front Panel Displays indicating Power Guard is active, last used source and volume setting. This is followed by the volume setting indication starting at zero and then increasing to the last used volume setting. Refer to figures 50, 51, 52 and 53. To switch OFF the MA/MAC6700, press the STANDBY/ON Push-button on the Front Panel or the OFF Push-button on the Remote Control.

Note: For an explanation of the Remote Control Push-button functions, refer to pages 18 and 19.



Figure 51



Figure 52

Source Selection

Rotate the INPUT Control to select the desired source or press the appropriate push-button on the Remote Control. Refer to figures 50 and 53.

Volume Control

Rotate the Front Panel VOLUME Control or use the VOLUME Up▲ or Down▼ Push-buttons on the Remote Control for the desired listening level. Refer to figures 50 and 53.

Trim Functions

The MA/MAC6700 has various Trim Selections with Adjustments. Refer to the following chart for the available Trim Selections. The Trim Settings are stored in memory independently for each Input Source Select-

ed, except the Meter Illumination and Digital Audio Display settings of On or Off, which are the same for all inputs.

Available Trim Functions			
Trim Function	MA6700	MA6700 or MAC6700 with TM2 Installed	MA6700 or MAC6700 with TM3 Installed
Balance	✓	✓	✓
Bass	✓	✓	✓
Treble	✓	✓	✓
Trim Level	✓	✓	✓
Tone Control	✓	✓	✓
Mono/Stereo	✓	✓	✓
Phono	✓	✓	✓
Display	✓	✓	✓
Digital Audio	✓	✓	✓
Meter Backlight	✓	✓	✓
Tuner Control	—	✓	✓
Tuner Text	—	✓	✓
Tuner Blend	—	✓	—

The selection and adjustment of all Trim Functions may be performed by first pressing the Front Panel INPUT/TRIM Control. Then rotate the INPUT/TRIM Control to select the desired Trim Function. This is followed by rotating the VOLUME Control to make a change/adjustment in the Trim Setting.

The Remote Control TRIM Push-Button together with the LEVEL + / - Push-button may also be used. Refer to figures 50 and 53.

After approximately 5 seconds the Display returns to indicate the Source Selection and Volume Level.

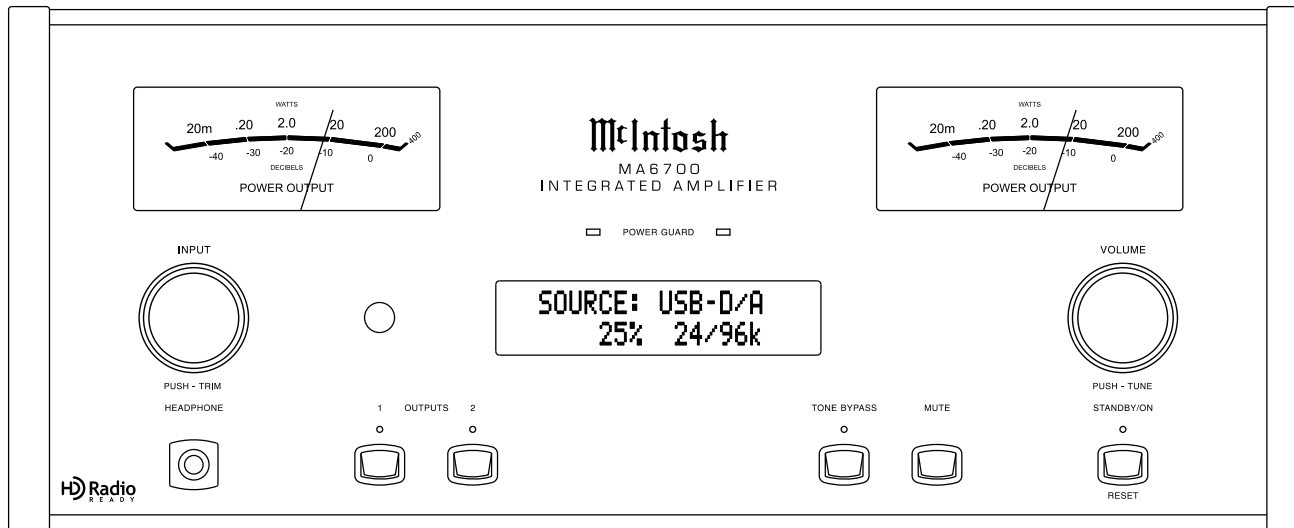

Figure 50

BALANCE

Listening balance varies with different program sources, room acoustics and listening positions relative to the Loudspeakers. Use the Balance (Trim Function) as needed to achieve approximately equal listening volume levels in each Loudspeaker. To adjust the Balance perform the following:

1. Press the TRIM Push-button repeatedly on the Remote Control until "BALANCE 0 dB" appears on the Front Panel Display. Refer to figure 54.

Note: The Front Panel INPUT/TRIM Control may also be used.

2. Rotate the VOLUME Control or press the LEVEL +/- Push-buttons on the Remote Control to emphasize the Right Channel (refer to figure 55) or the Left Channel (refer to figure 56).

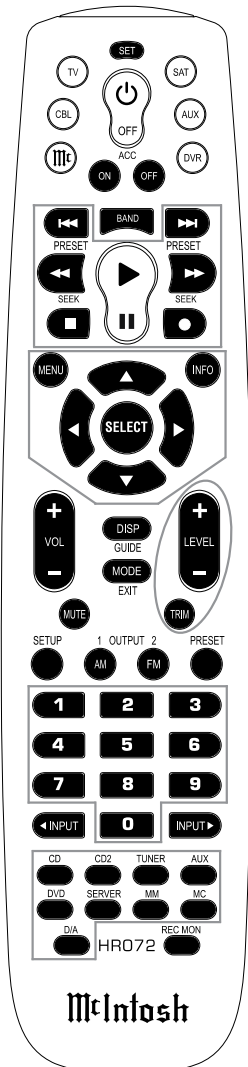

Figure 53



Figure 54



Figure 55



Figure 56

The Front Panel Display indicates the Balance changes in steps from 0 to 50dB. After approximately 5 seconds, the Display returns to indicate the Source Selection and Volume Level. To verify the Balance setting without changing it, use the TRIM Push-button and select Balance.

BASS

The Intensity of the Low Frequencies in the music can be increased or decreased by using the Trim Select and Trim Adjust Controls. To make an adjustment perform the following:

1. Using the Front Panel INPUT/TRIM Control or press the TRIM Push-button on the Remote Control until "BASS 0 dB" appears on the Front Panel Information Display. Refer to figure 57.



Figure 57

2. Rotate the INPUT/TRIM Control or press the LEVEL +/- Push-buttons to increase (refer to figure 58) or decrease (refer to figure 59) the volume level of the low frequencies.



Figure 58



Figure 59

The Front Panel Display indicates the Bass changes in steps from +12dB to -12dB. After approximately 5 seconds the Display returns to indicate the Source Selection and Volume Level.

TREBLE

The Intensity of the High Frequencies in the music can be increased or decreased by using the Trim Select and Trim Adjust Controls. To make an adjustment perform the following:

1. Using the Front Panel INPUT/TRIM Control or press the TRIM Push-button on the Remote Control until "TREBLE 0 dB" appears on the Front Panel Information Display. Refer to figure 60.



Figure 60

2. Rotate the INPUT/TRIM Control or press the LEVEL +/- Push-buttons to increase (refer to figure 61) or decrease (refer to figure 62) the volume level of the high frequencies.



Figure 61



Figure 62



How to Operate the MA/MAC6700, con't

The Front Panel Display indicates the Treble changes in steps from +12dB to -12dB. After approximately 5 seconds the Display returns to indicate the Source Selection and Volume Level.

TRIM LEVEL

Source Components can have slightly different volume levels resulting in the need to readjust the MA/MAC6700 Volume Control when switching between different sources. The MA/MAC6700 allows the adjustment of levels for each of the Source Inputs for the desired same relative volume. The CD and SERVER Inputs are used in the following example.

Note: The range of adjustment is ± 6 dB. The signal Level present at the RECORD OUT Jacks is unaffected by any changes in the Setup Level adjustment. The level adjustments made are retained in permanent memory. They can be changed during operation of the MA/MAC6700 by performing a Trim Level Procedure.

1. Press the CD Push-button on the Remote Control

and press the VOLUME Push-button +/- for the desired listening level.

2. Repeatedly press the TRIM Push-button on the Remote Control until "TRIM LEVEL: 0.0dB, Min Max" appears on the Front Panel Display. Refer to figure 63.



Figure 63

Note: The CD Input is serving as a reference level or choose another source frequently listened to. The Input Source should be set to a reference Level (Trim) of 0.0dB.

3. Press the SERVER Push-button on the Remote Control and note if the relative volume is louder or quieter than the volume level of the CD.
4. Repeatedly press the TRIM Push-button on the Remote Control until "TRIM LEVEL: 0.0dB, Min Max" appears on the Front Panel Display. Refer to figure 63.



Figure 64

5. Press the TRIM LEVEL +/- Push-button on the Remote Control to achieve the same relative volume as the CD Input. In our example the relative volume level of the Server Input is louder than the CD Input, so the trim level for the Server Input is reduced to -2.5 dB. Refer to figure 64.

6. Repeat steps 1 thru 4 until the relative volume is the same between the CD and SERVER Inputs.
7. Repeat the above steps for the remaining inputs with component sources connected until they all have the same relative volume levels. Record any changes made to the various inputs from the default settings in the "Input and Power Control Settings" chart on page 23.

After approximately 5 seconds the Display returns to indicate the Source Selection and Volume Level.

TONE CONTROL

With the Tone Bypass active, the Bass and Treble Settings for the currently selected Input Source are electronically bypassed and the LED above the TONE BYPASS Push-button will illuminate. When the Tone Bypass is switched Off, the previous settings for Bass and Treble will be restored (default setting). To activate Tone Bypass perform the following:

1. Select the desired Input by using the direct access Input Push-button on the Remote Control.
2. Press the TRIM Push-button on the Remote Control until "TONE CONTROL, _____ : ENABLE" appears on the Front Panel Display. Refer to figure 65.

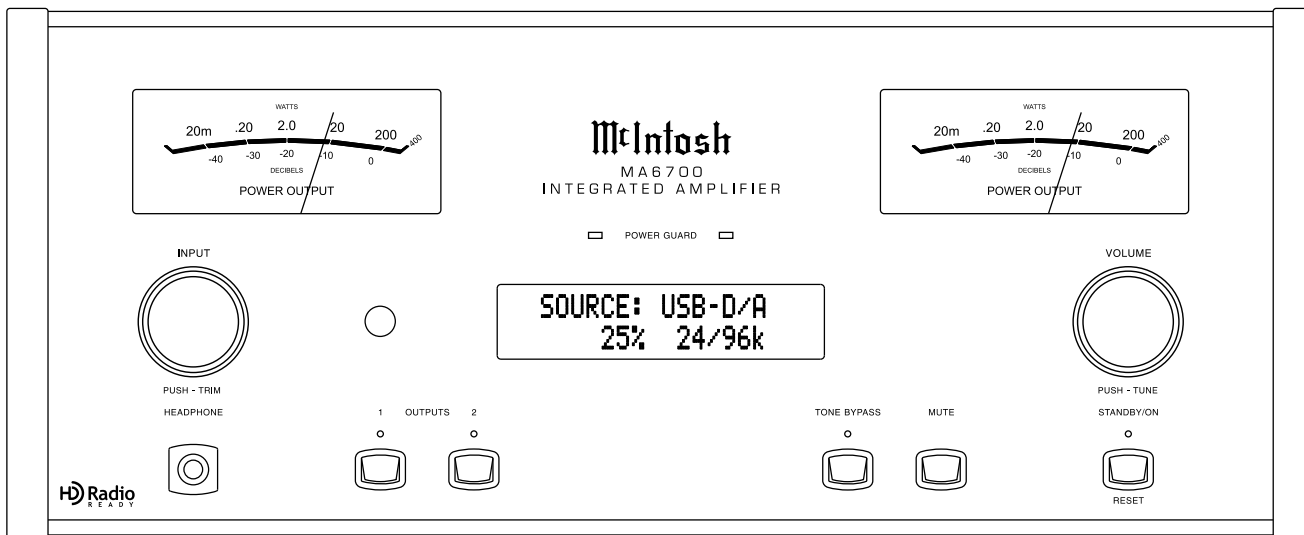

Figure 50



Figure 65

3. Press TRIM LEVEL +/- Push-button to activate the Tone Bypass. Refer to figure 66.



Figure 66

After approximately 5 seconds the Display returns to indicate the Source Selection and Volume Level.

MONO/STEREO MODE

By default the Stereo Mode is active for all Input Sources however, any Input Source may be assigned to Mono Mode. To change Stereo Mode to Mono for a given Input Source, perform the following steps:

1. Select the desired Input by using the direct access Input Push-button on the Remote Control.
2. Press the TRIM Push-button on the Remote Control until "MONO/STEREO MODE, _____ : Stereo" appears on the Front Panel Display. Refer to figure 67.



Figure 67

3. Press TRIM LEVEL +/- Push-button to select the MONO Mode. Refer to figure 68.



Figure 68

After approximately 5 seconds the Display returns to indicate the Source Selection and Volume Level.

PHONO ADJUSTMENTS

When the Phono MC Input is selected, an additional TRIM SELECT FUNCTION becomes available for adjustment. Perform the following steps to make the Phono Trim Adjustments:

1. Select Phono MC Source Input.
2. Press the TRIM Push-button on the Remote Control until "PHONO CARTRIDGE, Moving Coil: 200 Ohm" appears on the Front Panel Display. Refer to figure 69.



Figure 69

3. Press TRIM LEVEL +/- Push-button to select the desired phono cartridge loading value (50, 100, 200, 400 or 1000) Ohms that comes closest to the Phono Cartridge makers recommended value.

After approximately 5 seconds the Alphanumeric Display returns to indicate the Source Selection and Volume Level.

DISPLAY BRIGHTNESS

The Front Panel Display Brightness may be changed from the default setting. The MA/MAC6700 will remember two brightness preferences, one with the Meters Illuminated and one without Meter Illumination. For each preference there are four brightness settings for the Display. The Display Brightness setting may be varied 1 (Dim) to 4 (Bright). Follow the steps below for reducing the Display Brightness (with the Meter Illumination On):

1. Press the TRIM Push-button on the Remote Control until "DISPLAY, Bightness: 3" appears on the Front Panel Display. Refer to figure 70.



Figure 70

2. Press TRIM LEVEL +/- Push-button to select the desired Brightness.

Note: To change the Display Brightness preference with Meter Illumination Off, first switch Off the Meter Illumination (refer to page 34) and then change the Display Brightness Setting.

After approximately 5 seconds the Display returns to indicate the Source Selection and Volume Level.

DIGITAL AUDIO DISPLAY

By default the Digital Audio Display is switched Off. To display information about the type of digital signal present when any one of the three digital inputs is selected, perform the following steps:

1. Select one of the Inputs assigned to an active digital source.
Note: The USB-D/A Input may also be selected when the MA/MAC6700 is connected to a computer.
2. Press the TRIM Push-button on the Remote Control until "DIGITAL AUDIO, Display Info: On" is indicated on the Front Panel Display. Refer to figure 71.



Figure 71

3. If it is not desirable to display the information use the TRIM LEVEL +/- Push-button to switch it Off. Refer to figure 72.

After approximately 4 seconds the Display will return to indicate the Source Selection and Volume Level.



How to Operate the MA/MAC6700, con't

DIGITAL AUDIO
Display Info : Off

Figure 72

METER BACKLIGHT

The MA/MAC6700 Front Panel Meter Illumination may be switched On or Off by performing the following:

1. Press the TRIM Push-button on the Remote Control until “METER BACKLIGHT, Lights: On” appears on the Front Panel Display. Refer to figure 73.

METER BACKLIGHT
Lights: On

Figure 73

2. Press TRIM LEVEL + / - Push-button to switch Off the Meter Illumination. Refer to figure 74.

METER BACKLIGHT
Lights: Off

Figure 74

After approximately 5 seconds the Display returns to indicate the Source Selection and Volume Level.

- Notes:*
1. For information on how the Front Panel Display Brightness can change with the Meter Illumination On/Off Setting, refer to page 33 Setup “Display Brightness”.
 2. Meter Illumination of recent McIntosh Power Amplifiers will also switch On/Off when connected to the MA/MAC6700 via a power control cable.

NOTE: The following TRIM Settings of “Tuner Control” and “Tuner Text” are only available when a McIntosh TM2 or TM3 Tuner Module is installed in the MA6700 or MAC6700.

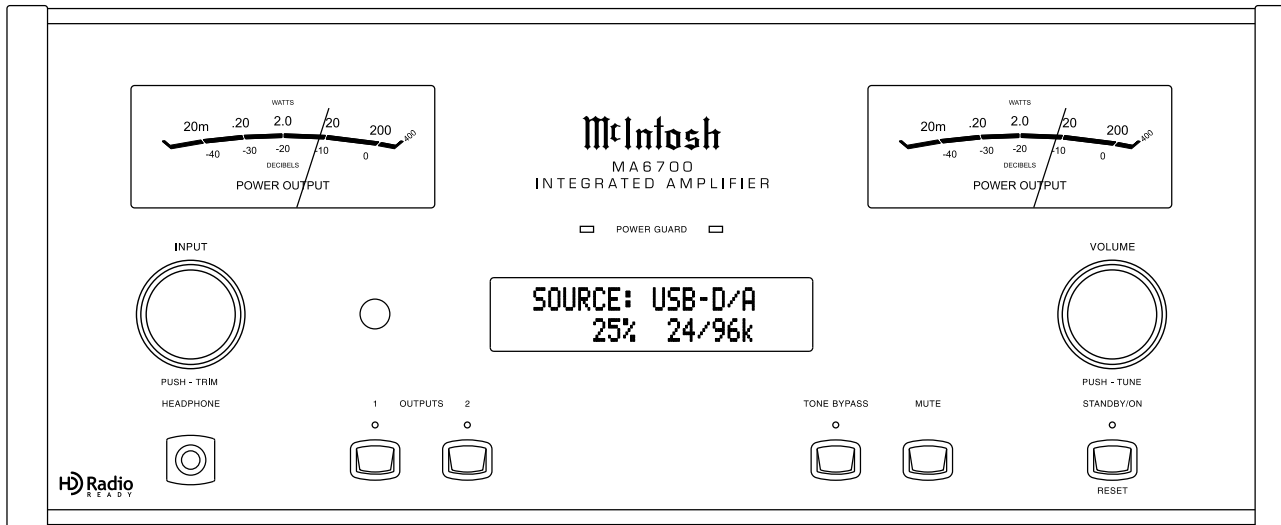

Figure 50

TUNER CONTROL

The Tuning Mode of AM and FM Broadcast Stations using the Front Panel VOLUME/TUNE Control may be changed from the default setting of STATIONS (Manual Tuning) by performing the following:

1. Press the TRIM Push-button on the Remote Control until “TUNER CONTROL, STATIONS” appears on the Front Panel Display. Refer to figure 75.

TUNER CONTROL
STATIONS

Figure 75

2. Press TRIM LEVEL + / - Push-button to select from the following choices:
 - A. STATIONS - Allows Manual Tuning of available AM and FM broadcasts (the default setting).
 - B. SEEK - Automatic Tuning of available AM and FM broadcast.
 - C. PRESET - Selection of AM and FM stations already entered into memory.

Refer to figures 76 and 77.

TUNER CONTROL
SEEK

Figure 76

TUNER CONTROL
PRESETS

Figure 77

After approximately 5 seconds the Display returns to indicate the Source Selection and Volume Level.

TUNER TEXT

The MA/MAC6700 Tuner Modules support displaying of text from many FM radio stations. When available from a FM Broadcast Station, the text information appears on the second line of Front Panel Display. It may also scroll from right to left, this is for information not possible to be displayed at the same time. This information may include some or all of the following:

- A. Station Call Letters and/or Frequency.
- B. Type of Program and/or music format.
- C. Name of the Artist.
- D. Name of the Song.

The displaying of the text, when available, on the MA/MAC6700 Front Panel Display may be switched Off (the default setting is On) by performing the following:

1. Press the TRIM Push-button on the Remote Control until "TUNER TEXT, Radio Text: On" appears on the Front Panel Display. Refer to 78.

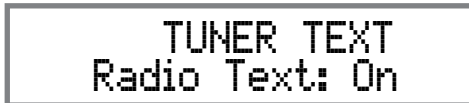

Figure 78

2. Press TRIM LEVEL +/- Push-button to switch Off the Tuner Text. Refer to figure 79.

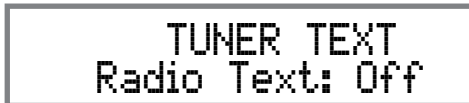

Figure 79

After approximately 5 seconds the Display returns to indicate the Source Selection and Volume Level.

NOTE: The following TRIM Setting of "Tuner Blend Mode" is only available when a McIntosh TM2 Tuner Module is installed in the MA6700 or MAC6700.

TUNER BLEND MODE

The BLEND MODE allows selection of the different signal types received from AM and FM Broadcast Stations. Conventional Radio Broadcast Signals contain Analog Audio Information only. A HD Radio™ Broadcast Signal includes both Analog Audio Information and Digital Audio Information. The Tuners Blend Mode may be changed from AUTO (default setting) to either the ANALOG ONLY or DIGITAL ONLY audio information. In the AUTO Blend Mode the Tuner Audio Output can vary between the transmitted Analog Audio only, the transmitted decoded Digital Audio only or a blending of the two. This blending produces the best possible sound quality even with varying reception conditions. To change from the AUTO Setting perform the following:

1. Press the TRIM Push-button on the Remote Control until "TUNER BLEND MODE, AUTO" appears on the Front Panel Display. Refer to 80.



Figure 80

2. Press TRIM LEVEL +/- Push-button to select the ANALOG ONLY or DIGITAL ONLY Mode. Refer to figures 81 and 82.



Figure 81



Figure 82

After approximately 5 seconds the Display returns to indicate the Source Selection and Volume Level.

Tone Bypass

Press the Front Panel TONE BYPASS Push-button to remove the MA/MAC6700 Tone Control Circuitry from the signal path for the currently selected Input Source. The LED above the TONE BYPASS Push-button will illuminate. Refer to figure 50. The MA/MAC6700 remembers for each selected Input whether the Tone Control Circuitry is deactivated. To reactivate the Tone Control Circuitry for the currently selected Input Source press the TONE BYPASS Push-button.

- Note:*
1. The audio signal present at the RECORD OUT Jacks is unaffected by the Tone Circuitry.
 2. The TONE BYPASS can also be accessed by the TRIM Function, refer to page 32.

Trim

Press the Front Panel INPUT/TRIM Control to activate the MA/MAC6700 Trim Functions. Rotate the Front Panel INPUT/TRIM Control to select the desired Trim Function and then rotate the VOLUME/ADJUST Control to vary or make changes. Refer to figure 50. The Remote Control TRIM and LEVEL +/- Push-buttons may also be used. Approximately 4 seconds after Trim Function Selection and/or adjustments have stopped the MA/MAC6700 will switch off the Trim Mode.

Mute

Press the MUTE Push-button to Mute the Audio in Output 1 (Loudspeakers), Output 2 and Headphones. The audio signals present at the REC OUTPUT jacks are not effected by activating the mute function. The Front Panel Display will indicate the Source Name and with the word MUTE in place of the actual volume setting. Refer to figure 83 on the next page.



How to Operate the MA/MAC6700, con't



Figure 83

Pressing the Mute Push-button a second time or adjusting the volume control will un-mute the MA/MAC6700.

Headphones Jack

Connect a pair of dynamic headphones to the Headphones Jack for private listening. Press OUTPUT 1 and/or 2 Push-buttons to mute the Loudspeakers. Refer to figure 50.

Note: The Headphone Output is optimized for impedances ranging from 20 to 600 ohms.

Power Output Meters

The MA/MAC6700 Power Output Meters indicate the power delivered to the Loudspeakers. Refer to figure 84. The meters respond to all the musical information being produced by the Amplifier. They indicate to an

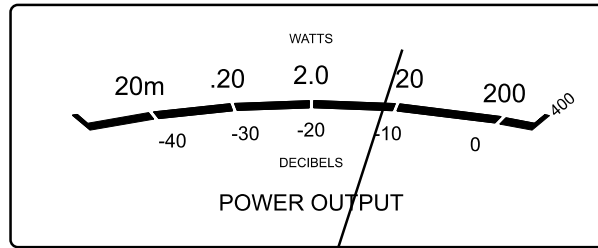

Figure 84

accuracy of at least 95% of the power output with only a single cycle of a 2,000Hz tone burst.

Power Guard

During normal operation, the Front Panel Power Guard Indicators will momentarily illuminate during peaks in the audio signals. In the event the MA/MAC6700 over heats, due to improper ventilation, high ambient temperature and/or impedance mismatch, the internal protection circuits will activate. The Front Panel Power Guard Indicators will continuously illuminate and the audio will be muted. When

the MA/MAC6700 has returned to a safe operating temperature, normal operation will resume.

How To Make a Recording

1. Select the desired signal source you wish to record by using the Front Panel INPUT Control or the appropriate Source Push-button on the Remote Control.
2. Adjust the record level using the recorder volume control and proceed with the recording process.
3. To listen to the playback of the program source just recorded select the SERVER Input.

Note: The MA/MAC6700 REC OUTPUTS are not affected by the VOLUME, BALANCE or TONE Control Settings.

Using a Separate Power Amplifier

There are two different ways to use a separate power amplifier with a MA/MAC6700. The first way is to use the separate amplifier instead of the MA/MAC6700 built-in Power Amplifier. Connect the Loudspeakers to the separate power amplifier and remove the McIntosh Jumpers that are located between the OUTPUTS 1 Jacks and the PWR AMP INPUT Jacks. Refer to figure 85.

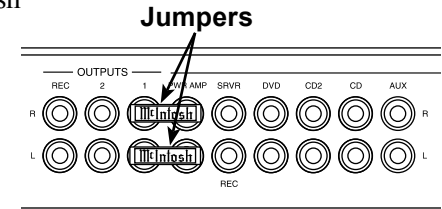

Figure 85

Note: The McIntosh Jumpers must be connected, between the above mentioned jacks, when the MA/MAC6700 Internal Power Amplifier is to be used.

The second way is to use both a separate power amplifier and the MA/MAC6700 built-in Power Amplifier. Connect one pair of Loudspeakers to the

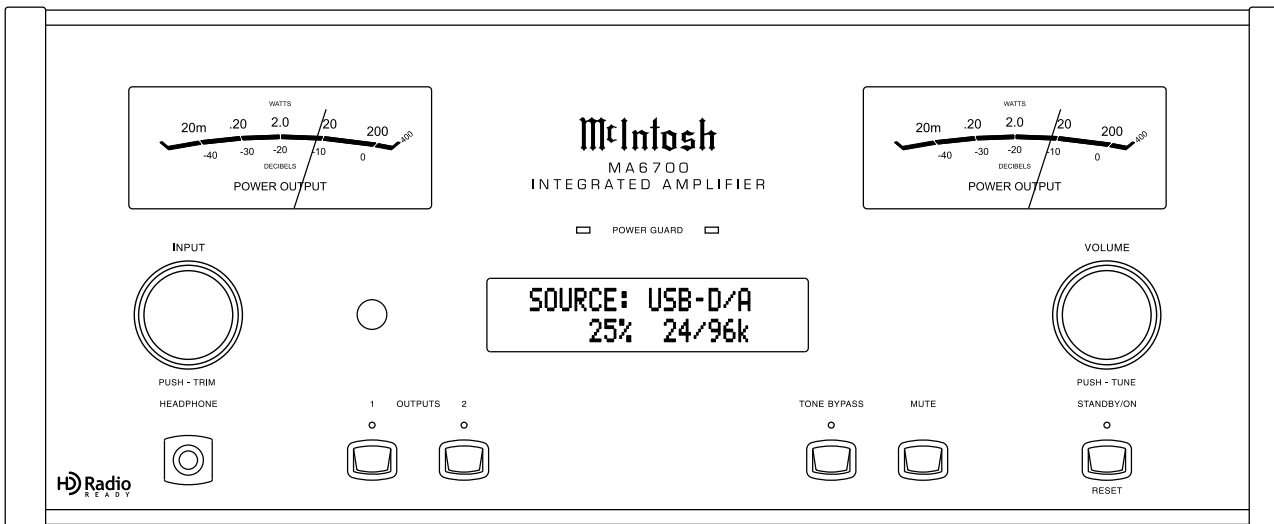

Figure 50

separate power amplifier and the second pair to the MA/MAC6700.

Refer to the MA/MAC6700 Output Connection Diagrams located on the separate folded sheet "Mc1B" and figure 86.

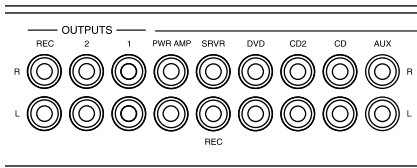

Figure 86

Note: The MA/MAC6700 VOLUME Control will affect the sound level of all the Loudspeakers.

Using Output 2

The MA/MAC6700 has provisions for connecting an external Power Amplifier (to drive Loudspeakers in another room) and an external sensor for remote operation of the MA/MAC6700 from that room. With an external Power Amplifier connected (as illustrated on the McIntosh Connection Diagram separate sheet "Mc1B"), press the Front Panel OUTPUT 2 Push-button or press on the Remote Control the 2nd Push-button followed by pressing the OUTPUT 2 Push-button to switch On or Off the external Power Amplifier.

Passthru

When the MA/MAC6700 is connected together with a McIntosh Multichannel A/V Control Center or Surround Decoder and has the PASSTHRU Mode activated, it will automatically turn-on when the A/V Control Center or Surround Decoder is turned On. It will indicate on the Front Panel Display "PASSTHRU". Refer to figure 87.



Figure 87

The MA/MAC6700 OUTPUT 1 / OUTPUT 2 Front Panel Push-buttons are active when in the Passthru Mode. The other Front Panel Controls and Push-buttons are deactivated as long as the Passthru Mode is active.

USB Input Operation with a Computer

The MA/MAC6700 USB-D/A Input provides the capability to playback music from a computer, when the computer is connected to the rear panel USB D/A connector. The MA/MAC6700 USB Input is compatible with both PC Computers using Microsoft® Windows® (XP with Service Pack 3, Vista with Service Pack 1 and Windows 7) and the Apple® Macintosh® Computers using OS-10.6 with the latest update.

When using a PC Computer with Windows, a special McIntosh USB Audio Software Driver needs to be installed on the PC Computer. The driver needs to be installed before connecting the MA/MAC6700 USB Input to an USB Port on the computer.

Note: If an Apple Macintosh computer is used with the MA/MAC6700, no additional driver is required.

The McIntosh USB Audio Windows Driver and Installation and Operation Guide are available for download from the McIntosh Web Site:

<http://www.mcintosh-labs.com/us/support/Pages/Manuals.aspx>

Under "Product Category" select Preamplifiers and under "Model Number" select MA/MAC6700, then click on "Select". When the MA/MAC6700

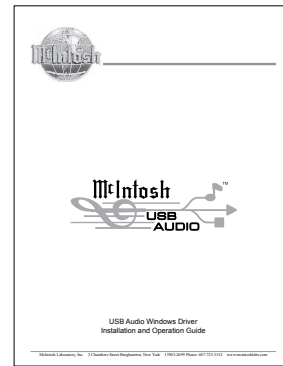

information appears, download the "McIntosh Audio Windows Driver Installation and Operation Guide" and "McIntosh USB Audio Windows Driver V_ . _". Follow the instructions in the Guide and after the USB Driver is installed, connect the MA/MAC6700 to the PC Computer.

Note: When computer application programs and various computer hardware components conform to the Microsoft® Windows® and Apple® Macintosh® standards, they should also work well when used in conjunction with the MA/MAC6700 USB Input. If you are experiencing difficulty with a specific computer hardware component or computer application program, contact the manufacturer of the product.

The MA/MAC6700 Front Panel Display will indicate the Bit and Sampling Rate of the incoming digital signal. Refer to figure 88.



Figure 88

Reset of Microprocessors

In the unlikely event the controls of the MA/MAC6700 stop functioning, the microprocessors can be reset by performing the following:

1. Press the STANDBY/ON Push-button until the STANDBY/ON Indicator switches Off.
2. When the MA/MAC6700 cycles On then Off, release the STANDBY/ON Push-button.
3. When the STANDBY/ON LED is illuminated press the STANDBY/ON Push-button, the MA/MAC6700 will resume normal operation.

Note: This can be performed with the MA/MAC6700 On or in the Standby Mode.

How to Operate the MA/MAC6700, con't

Resetting the MA/MAC6700 to default settings

If it becomes desirable to reset all the adjustable settings (Setup and Trim Settings) to the factory default values, perform the following:

1. Press in and hold the INPUT/TRIM Control and the VOLUMES/ADJUST Control. The Front Panel Display will indicate "FACTORY RESET". Refer to figure 89.



FACTORY RESET

Figure 89

2. When the Front Panel Display indicates "FACTORY RESET, COMPLETE" release the two controls. Refer to figure 90.



FACTORY RESET
-COMPLETE-

Figure 90

3. Press the STANDBY/ON Push-button and the MA/MAC6700 will resume operation.

Operating the TM2 and TM3 Tuner

When the MA6700 has an optional McIntosh Tuner Module installed, the module provides the ability to receive and listen to AM and FM Radio Stations. The MAC6700 comes with a McIntosh Tuner Module installed from the factory. The instructions that follow are for operating the tuner functions of the installed McIntosh Tuner Module in the MA/MAC6700.

If an external McIntosh Tuner Component is connected to either the MA6700 or MAC6700 please refer to the Owner's Manual supplied with the tuner component for Radio Station reception.

The Front Panel Control labeled VOLUME/TUNE serves a dual operational function together with the Front Panel Display. When the display indicates "SOURCE: TUNER __, 0-100%" the Front Panel VOLUME/TUNE Control will adjust the listening volume level as it is rotated. Refer to figures TM2 and TM3. If the Front Panel Display is indicating a radio station frequency such as illustrated in figures TM4 and TM5, the VOLUME/TUNE Control allows



Figure TM2

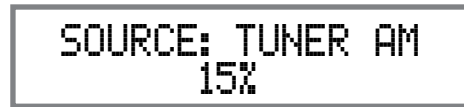

Figure TM3

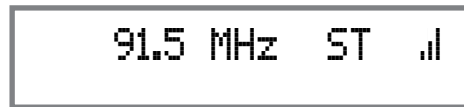

Figure TM4



Figure TM5



Figure TM6

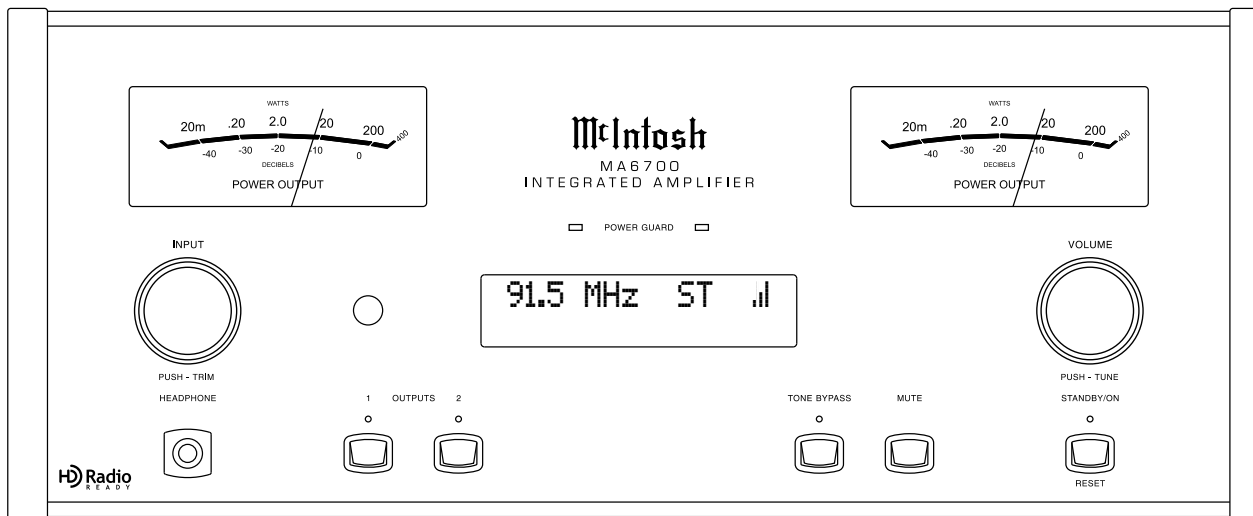

Figure TM1

for tuning in a radio station (Manual Tuning, Seek Tuning or Preset Tuning). By momentarily pushing in on the VOLUME/TUNE Control and then rotating it, the listening level will change or the radio station tuned to will change.

AM or FM Band Selection

Rotate the MA/MAC6700 Front Panel INPUT Control to select either TUNER FM or TUNER AM. The AM or FM Push-buttons on the Remote Control may also be used to select the desired broadcast band. Refer to figures TM1, TM2, TM3 and TM7. Several seconds after the AM or FM Band is selected the Front Panel Display will change to indicate the frequency and signal strength of the station the tuner is currently tuned to. Refer to figures TM4 and TM5.

Manual Tuning

The default Tuning Mode for the MA/MAC6700 is STATIONS (Manual Tuning). After having selected the FM or AM Broadcast Band, push the VOLUME/TUNE Control then rotate the Control clockwise or counterclockwise to find the desired radio station. Refer to figures TM1 and TM4. The Remote Control may also be used for manual tuning of stations by

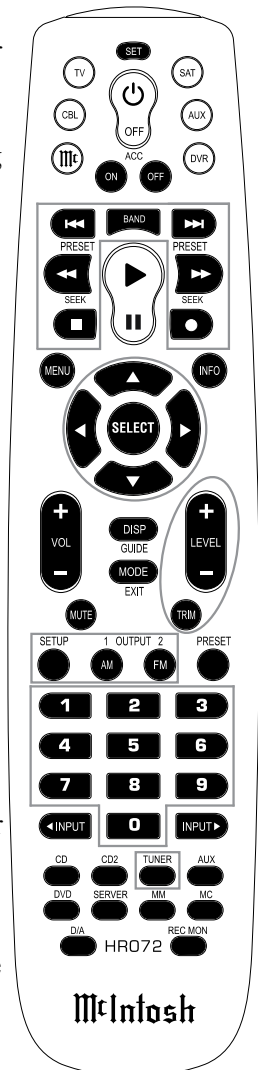

Figure TM7



Operating the TM2 and TM3 Tuner, con't

using the Up▲ or Down▼ Directional Push-buttons. Refer to figure TM7 on page 39.

The Signal Strength Indication (to the right of “ST”) displayed on the Front Panel Display can assist in orienting the Antenna for maximum signal. Refer to figure TM6 (minimum signal strength) and TM4 (maximum signal strength) on page 39.

Preset Tuning

The MA/MAC6700 allows for presetting 20 AM and 20 FM Radio Stations into memory for rapid recall without having to manually tune through unwanted stations.

Creating Presets

Tune to a station to be entered into memory either by Manual Tuning (STATIONS Tuning Mode) or Automatic Tuning (SEEK Tuning Mode) and then perform the follow steps:

1. Press the PRESET Push-button and the Front Panel Display will indicate there are “No Presets Stored”. Refer to figure TM8.



Figure TM8

2. Press and hold in the the VOLUME/TUNE Control and Front Panel Display will indicate “91.5Mhz ST, PRESET 1: AVAILABLE”, which is the first of 20 Preset Numbers available for assignment. Refer to figure TM9.



Figure TM9

The Station to be entered into memory may also be assigned to a different Preset Number (2-20) by rotat-

ing the VOLUME/TUNE Control to select the desired Preset Number.

Notes: 1. Presets are automatically assigned in order from 1 to 20 unless a different Preset Number is selected.

2. If the desired Preset Number is already assigned, the current station will replace the previously stored station.

3. To enter the station into memory, press and hold in the VOLUME/TUNE Control until the Front Panel Display indicates “PRESET STORED”, then release the Control. Refer to figure TM10.



Figure TM10

The just entered Station Preset will be assigned Preset Number 1 (or the Preset number you selected) and is displayed on the Front Panel Display. Refer to figure TM11.

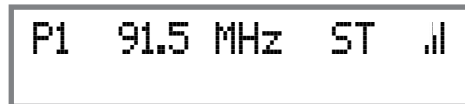

Figure TM11

4. Assign additional station Presets by performing steps 2 and 3.

Note: If all 20 Presets are assigned and an attempt is made to enter another preset station, the Tuner will return to Preset 1 and will overwrite it or you can select another preset number.

5. To verify the Station Preset(s) just entered into memory, press the PRESET NEXT ►► or BACK ◄◄ Push-buttons to cycle through and confirm your preset assignments.

Note: If the Tuner TRIM Mode is set to “PRESETS”, the Front Panel VOLUME/TUNE Control may also be used.

Clearing Presets

6. Select the Station Preset to be removed.
7. Press and hold in the Front Panel VOLUME/TUNE Control until the Front Panel Display indicates “P1 91.5Mhz ST, PRESET CLEARED” then release the Control. Refer to figure TM12.



Figure TM12

8. To clear any additional Station Presets perform steps 5 through 6 again.

After Preset Stations have been entered into memory, the VOLUME/TUNE Control may be used to select Presets by first using the Tuner Control Trim Function to Select the Front Panel PRESET Tuning Mode. To select a Preset Station press and then rotate the Front Panel VOLUME/TUNE Control for the desired station. Using the Remote Control, Presets are selectable with the NEXT ►► or BACK ◄◄ Push-buttons. Direct access is also possible by first pressing the PRESET Push-button followed by entering the number of Preset using the 1-20 numeric push-buttons on the Remote Control.

Automatic Tuning

The SEEK Tuning Mode (Automatic Tuning) searches the AM or FM Broadcast Bands for available stations. To use the SEEK Tuning Mode perform the following steps:

1. Use the TRIM Tuner Control Mode to select the SEEK Tuning Mode.
2. Press the SEEK Push-buttons to go ◄◄(down) or ►►(up) the dial, the Tuner will automatically stop on the next station. The VOLUME/TUNE Control may also be used by first pressing it in, then giv-

ing the control a quick spin and releasing it, either clockwise or counterclockwise.

- Notes:* 1. If the signal strength of a station is very weak *SEEK Tuning will not stop.*
 2. When there is lot of RFI (Radio Frequency Interference) the tuner may stop on the interference signal instead of a station.

Direct Access Tuning

The MA/MAC6700 Tuner Module allows for direct AM or FM station access using the Numeric Push-buttons on the Remote Control. In the following example the Tuner is currently tuned to a station at 91.5MHz and the station to be tuned to is at 103.3MHz. Perform the following steps:

1. The Front Panel Display is currently indicating 91.5MHz, stereo, signal strength and text information. Refer to figure TM13.



Figure TM13

2. Start entering the desired station frequency of 103.3MHz using the Remote Control Numeric Push-buttons by pressing the number 1, 0, 3, 3. Refer to figures TM14 and TM15.



Figure TM14

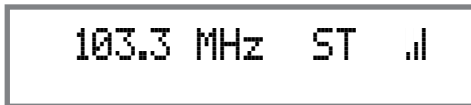

Figure TM15

The same procedure is used when direct accessing an AM Station.

Stereo/Mono Mode

The MA/MAC6700 Tuner Module Automatically switches between Stereo and Monaural Broadcasts. When a Stereo Broadcast is received, the Front Panel Display indicates the Stereo Mode by the letters “ST” on the right side. Refer to figure TM15. To change the reception mode to MONO press the MODE Push-button on the Remote Control twice to combine left and right Stereo signal to a Monophonic Signal. Refer to figures TM15 and TM16.

Note: To return to the STEREO MODE press the MODE Push-button twice.



Figure TM16

Text Information

The MA/MAC6700 Tuner supports display of text from many FM radio stations. When available from a FM Broadcast Station, the text information appears on the second line of the Front Panel Display. It may also scroll from right to left, this is for information not possible to display at the same time. This information may include some or all of the following:

- A. Station Call Letters and/or Frequency.
- B. Type of Program and/or music format.
- C. Name of the Artist.
- D. Name of the Song.

Also refer to figures TM17, TM18, TM19 and TM20 for examples of Text Information.



Figure TM17

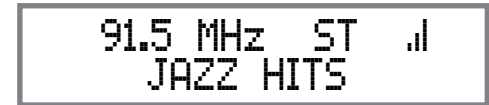

Figure TM18



Figure TM19



Figure TM20

Note: Reception of a weak broadcast signal sending out Text Information might result in an interruption of the text information and/or incorrect characters displayed. If this occurs, try re-orienting the FM Antenna and/or replacing the antenna with an improved reception model. See your McIntosh Dealer for assistance.

- NOTES:* 1. The following information is only applicable when a McIntosh TM2 Tuner Module is installed in the MA6700 or MAC6700.
 2. The McIntosh TM2 Tuner Module is used in the U.S.A., Argentina, Bolivia, Brazil, Canada, Chile, Columbia (most of the available FM Stations and all of the AM Stations), Ecuador, Mexico, and Venezuela.

HD Radio Reception

Tuning to a HD Radio Station on the MA/MAC6700 is the same as tuning to any AM or FM Broadcast. Once the MA/MAC6700 is tuned to a HD Radio Station Broadcast several benefits are immediately apparent. First, there is the improvement in sound fidelity and sonic imaging. Second, many Stations will offer

Operating the TM2 and TM3 Tuner, con't

the choice of listening to Multiple Programs. Lastly, most HD Radio Stations send out Text Information which is displayed on the Front Panel of the MA/MAC6700.

When tuned to a HD Radio Station the Front Panel Display will indicate HD1. Refer to figure TM21.

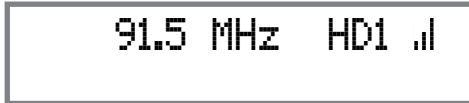

Figure TM21

Shortly there after the Texting information will appear on the Front Panel Information Display. Refer to figures TM22 and TM23.



Figure TM22

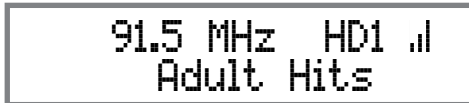

Figure TM23

The Front Panel Display will also indicate the number of the program selected with the number to the right of "HD"; example, "HD1", "HD2", "HD3" etc. When the Station is sending out more than one program, the Front Panel Display will also indicate an arrow to the right side of "HD1" when the first program is selected and there are additional programs above the program currently selected. An additional arrow on the left side of "HD" will appear when there are programs available below the program currently selected. Refer to figures TM24, TM25, TM26 and TM27.

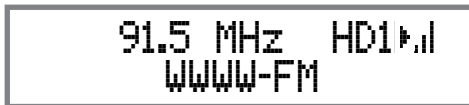

Figure TM24



Figure TM25



Figure TM26

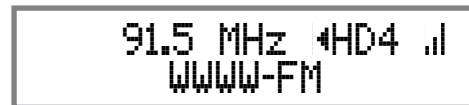

Figure TM27

To select HD Radio Station Programs perform one of the methods below, after the Front Panel Display indicates HD1 with an arrow. Refer to figure TM24.

Note: A HD Radio Station with additional Programs (HD2, HD3, etc.) may choose to air those additional Programs for only a few hours a day and/or only on certain days of the week. If a MA/MAC6700 Station Preset is assigned to one or more of the HD Radio Programs and the radio station is not currently airing that program the tuner will switch to the HD1 Program.

Manual HD Radio Program Selection

1. Rotate the VOLUME/TUNE Control to select the desired program from the HD Radio Broadcast or press the Right▶ or Left◀ directional Push-buttons on the Remote Control.

Note: A HD Radio Station Program may be assigned to a Preset (stored in memory) by pressing and holding in the VOLUME/TUNE Control, rotate the Control to select an available Preset number, then press and hold in the Control until the Front Panel Display indicates "PRESET STORED".

Selecting HD Radio Program Preset

2. Select the HD Radio Program Preset by using the Remote Control PRESET ▶▶ or PRESET ◀◀ Push-buttons on the Remote Control.

Amplifier Specifications

Power Output

200 watts is the minimum sine wave continuous average power output per channel, both channels operating

Output Load Impedance

2, 4 or 8 ohms

Rated Power Band

20Hz to 20,000Hz

Total Harmonic Distortion

0.005% maximum with both channels operating from 250 milliwatts to rated power, 20Hz to 20,000Hz

Dynamic Headroom

2.0dB

Frequency Response

+0, -0.5dB from 20Hz to 20,000Hz

+0, -3dB from 10Hz to 100,000Hz

Preamplifier Output 1 and 2 (for rated input)

1.4V unbalanced (8V Maximun)

Sensitivity (for rated output)

High Level, 250mV unbalanced, 500mV balanced

Phono MM, 2.5mV

Phono MC, 0.25mV

Power Amp In, 1.4V

Signal To Noise Ratio (A-Weighted)

High Level, 95dB below rated output

Phono MM, 84dB below 5mV input

Phono MC, 82dB below 0.5mV input

Power Amplifier, 113dB below rated output

Intermodulation Distortion

0.005% maximum, if the instantaneous peak power is 400 watts or less per channel with both channels operating for any combination of frequencies from 20Hz to 20,000Hz

Wide Band Damping Factor

Greater than 40

Input Impedance

High Level, 20K ohms

Phono MM, 47K ohms; 50pF

Phono MC, 50, 100, 200, 400 or 1,000 ohms; 100pF

Power Amp In, 10K ohms

Maximum Input Signal

High Level, 8V unbalanced, 16V balanced

Phono MM, 80mV

Phono MC, 8mV

Power Amplifier In, 16V

Preamplifier Output Impedance

220 ohms

Headphone Output Impedance

20 to 600 ohms

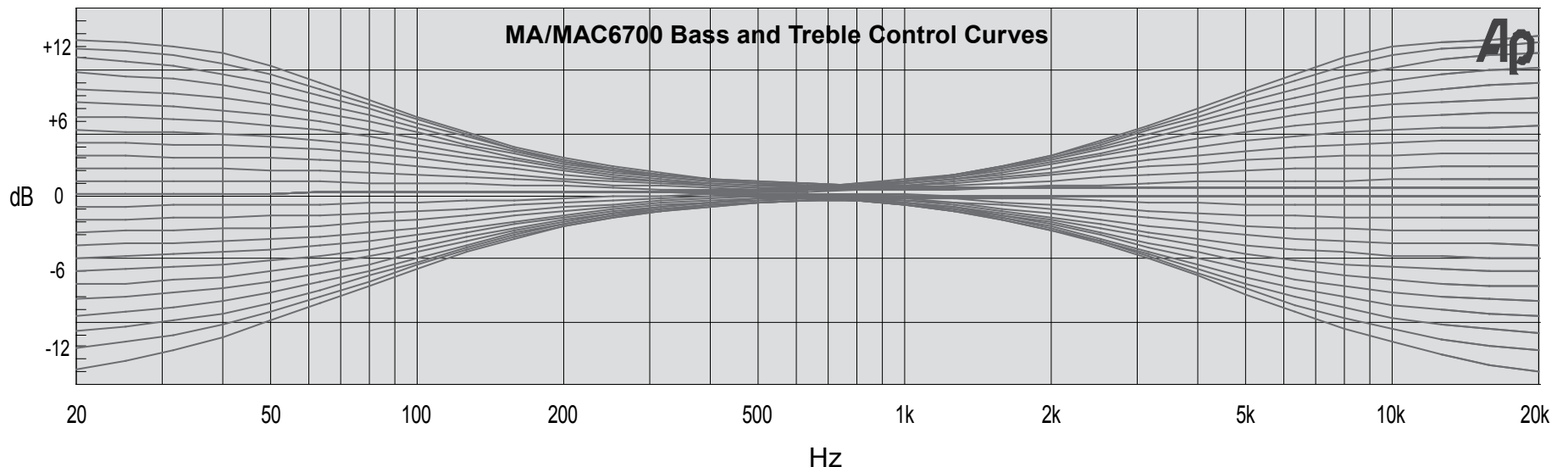



Amplifier Specifications, con't

Power Guard

Less than 2% THD with up to 16dB overdrive at 1,000Hz

Voltage Gain

High Level to Rec Output: 0dB
High Level to Output 1 and 2: 15dB
Phono MM to Rec Output: 40dB
Phono MC to Rec Output: 60dB
Phono MM to Output 1 and 2: 55dB
Phono MC to Output 1 and 2: 75dB
Power Amplifier: 29dB

Tone Controls

Bass Control ± 12 dB (1dB steps) @ 30Hz
Treble Control ± 12 dB (1dB steps) @ 10,000Hz

Digital Input Sample Rates

Optical: 16Bit, 24Bit - 32kHz to 96kHz
Coaxial: 16Bit, 24Bit - 32kHz to 96kHz
USB: 16Bit, 24Bit, 32Bit - 32kHz to 192kHz

Power Control and Trigger Output

12VDC, 25mA

TM2 - FM HD Radio Specifications

Sensitivity

-85dBm

Signal To Noise Ratio

85dB

Frequency Response

± 1 dB from 20 to 20,000Hz

Harmonic Distortion

0.1%

Stereo Separation

80dB

TM2 - FM Analog Specifications

FM Tuning Range

87.5MHz - 107.9MHz

FM Channel Spacing

200kHz

Useable Sensitivity

1.6uV (15.2dBf)

50dB Quieting Sensitivity

1.8uV (16.2dBf)

Signal To Noise Ratio

Mono: 75dB
Stereo: 72dB

Frequency Response

± 1 dB from 20 to 13,000Hz

Harmonic Distortion

Mono: 0.1%

TM2 - FM Analog Specifications, con't

Stereo: 0.4%

Channel Selectivity

65dB Adjacent Channel
74dB Alternate Channel

Stereo Separation

35dB

TM2 - AM HD Radio Specifications

Signal To Noise Ratio

85dB

Frequency Response

20 to 15,000Hz

Harmonic Distortion

0.1%

Stereo Separation

75dB

TM2 - AM Analog Specifications

AM Tuning Range

530kHz - 1710kHz

AM Channel Spacing

10kHz

Sensitivity

550uV/m

Signal To Noise Ratio

45dB

Frequency Response

+ 0, - 6dB from 100 to 3,500Hz

TM2 - AM Analog Specifications, con't

Harmonic Distortion
0.25%, 80% Modulation

Selectivity
50dB Adjacent Channel

TM2 - General Specifications

FM Antenna Input
75 ohms, Type "F" Coax connector

AM Antenna Input
Balanced, RJ45 connector
(for use only with supplied McIntosh RAA2 Remote AM Antenna)

RAA2 Connection Cable
20 foot (6.09m) 8 conductor straight-thru cable with an outer shield and RJ45 connectors on each end (shielded CAT5 or CAT6 patch cable)

RAA2 Remote AM Antenna Overall Dimensions
Width is 6 inches (15.24cm)
Height is 2-1/2 inches (6.35cm)
Depth is 1-1/2 inches (3.81cm)

TM2 and RAA2 Weight
1 pounds (0.4 kg) net, 2 pounds (0.8 kg) in shipping carton

Shipping Carton Dimensions
Width is 12-1/4 inches (31.12cm)
Depth is 9-1/4 inches (23.5cm)
Height is 5 inches (12.7cm)

TM3 - FM Specifications

Tuning Range
87.5MHz - 108.0MHz (Europe)
87.9MHz - 107.9MHz (USA)
76MHz - 90MHz (Japan)

FM Channel Spacing
200kHz (USA, Japan)
50kHz (Europe)

Antenna Input
75 Ohms, Type "F" Coax connector

Useable Sensitivity
2.2uV (18.1dBf)

50dB Quieting Sensitivity
1.5uV (14.8dBf)

Signal To Noise Ratio
Mono: 70dB
Stereo: 68dB

Frequency Response
±1dB 20 to 15,000Hz

Harmonic Distortion
Mono: 0.4%
Stereo: 0.8%

Channel Selectivity
60dB Adjacent Channel
66dB Alternate Channel

Stereo Separation
38dB

TM3 - AM Specifications

AM Tuning Range
522kHz - 1602kHz (Europe)
530kHz - 1710kHz (USA)
522kHz - 1611kHz (Japan)

AM Channel Spacing
10kHz (USA)
9kHz (Europe, Japan)

Sensitivity
350uV/m

Signal To Noise Ratio
50dB

Frequency Response
0dB, -6dB 50Hz to 3,000Hz

Harmonic Distortion
0.5%

Selectivity
45dB Adjacent Channel

TM3 - General Specifications

FM Antenna Input
75 ohms, Type "F" Coax connector

AM Antenna Input
Balanced, RJ45 connector
(for use only with supplied McIntosh RAA2 Remote AM Antenna)

RAA2 Connection Cable
20 foot (6.09m) 8 conductor straight-thru cable with an



TM3 - General Specifications, con't

outer shield and RJ45 connectors on each end (shielded CAT5 or CAT6 patch cable)

RAA2 Remote AM Antenna Overall Dimensions

Width is 6 inches (15.24cm)
Height is 2-1/2 inches (6.35cm)
Depth is 1-1/2 inches (3.81cm)

TM3 and RAA2 Weight

1 pounds (0.4 kg) net, 2 pounds (0.8 kg) in shipping carton

Shipping Carton Dimensions

Width is 12-1/4 inches (31.12cm)
Depth is 9-1/4 inches (23.5cm)
Height is 5 inches (12.7cm)

General Specifications

Power Requirements

Field AC Voltage conversion of the MA/MAC6700 is not possible. The MA/MAC6700 is factory configured for one of the following AC Voltages:

100 Volts, 50/60Hz at 5.2 amps
110 Volts, 50/60Hz at 4.4 amps
120 Volts, 50/60Hz at 4.4 amps
220 Volts, 50/60Hz at 2.45 amps
230 Volts, 50/60Hz at 2.35 amps
240 Volts, 50/60Hz at 2.25 amps
Standby: Less than 0.25 watt

Note: Refer to the rear panel of the MA/MAC6700 for the correct voltage.

Overall Dimensions

Width is 17-1/2 inches (44.45cm)
Height is 7-5/8 inches (19.37cm) including feet
Depth is 22 inches (55.88cm) including the Front Panel, Knobs and Cables

Weight (MA6700)

74 pounds (33.6 kg) net, 92 pounds (41.7 kg) in shipping carton

Weight (MAC6700)

75 pounds (34.1 kg) net, 93 pounds (42.3 kg) in shipping carton

Shipping Carton Dimensions

Width is 29-1/2 inches (74.93cm)
Depth is 29 inches (73.66cm)
Height is 17 inches (43.18cm)

Packing Instructions

In the event it is necessary to repack the equipment for shipment, the equipment must be packed exactly as shown below. It is very important that the four plastic feet are attached to the bottom of the equipment. Two #10 x 2-1/2 inch screws and washers must be used to fasten the unit securely to the bottom pad and wood skid. This will ensure the proper equipment location on the bottom pad. Failure to do this will result in shipping damage. Use the original shipping carton and interior parts only if they are all in good serviceable condition. If a shipping carton or any of the interior part(s) are needed, please call or write Customer Service Department of McIntosh Laboratory. Refer to page 3. Please see the Part List for the correct part numbers.

MA/MAC6700 Packing Material List

Quantity	Part Number	Description
1	033888	Shipping carton
4	033887	End Cap
1	033697	Inner carton
1	033725	Top pad
1	034301	Bottom pad
1	034480	Wood skid
2	017218	Plastic foot (spacer)
2	401204	#10 x 2-1/2 inch wood screw
2	404033	#10 flat washer 1-3/4 inch
4	017937	Plastic foot
4	400159	#10-32 x 3/4 machine screw
4	404080	#10 flat washer

TM2 and TM3 Packing Material List

Quantity	Part Number	Description
1	034415	Shipping carton complete
1	034134	Antistatic bag

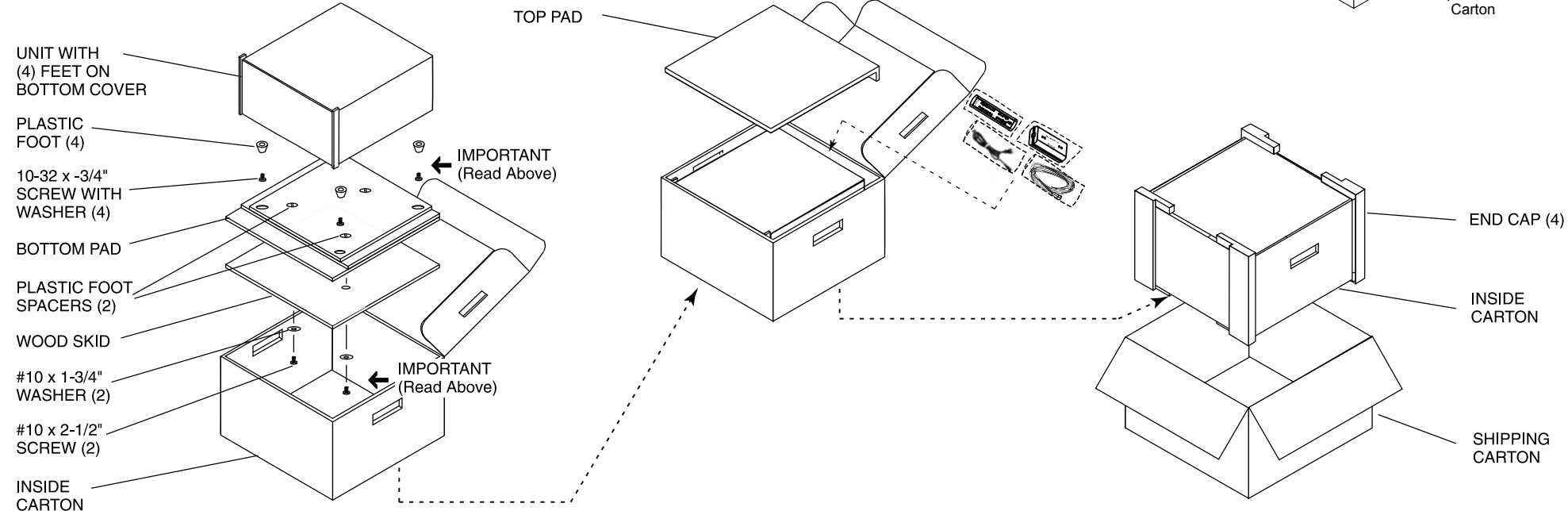
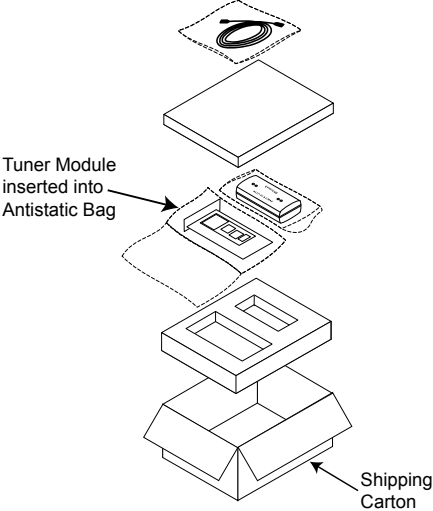



McIntosh Laboratory, Inc.
2 Chambers Street
Binghamton, NY 13903
www.mcintoshlabs.com

The continuous improvement of its products is the policy of McIntosh Laboratory Incorporated who reserve the right to improve design without notice.
Printed in the U.S.A.