

# SERVICE MANUAL

## CR-1020

FM/AM STEREO RECEIVER

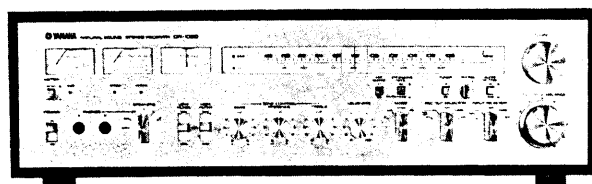

SINCE 1887



# YAMAHA

NIPPON GAKKI CO., LTD. HAMAMATSU, JAPAN

# CONTENTS

PANEL OPERATION .....	2
SPECIFICATIONS .....	4
CHARACTERISTIC CHARTS .....	5
BLOCK DIAGRAM .....	6
FLOW CHART FOR DISASSEMBLY PROCEDURES .....	7
DISASSEMBLY PROCEDURES .....	8
DIAL CORD STRINGING .....	11
ADJUSTMENT ADJUSTMENT OF MAIN AMP. C.BOARD & LEVEL METER .....	12
ADJUSTMENT OF TUNER C.BOARD .....	13
CIRCUIT BOARDS POWER SUPPLY C. BOARD 1 .....	16
TUNER C. BOARD 1 .....	17
PRE C. BOARD 1, 2 .....	18
MAIN C. BOARD & POWER SUPPLY C. BOARD 2 .....	19
ELECTROLYTIC C. BOARD & etc. ....	20
PACKAGE .....	21
SCHEMATIC DIAGRAM BY EXPORT ZONE .....	22
SCHEMATIC DIAGRAM .....	23
WIRING .....	24

# PANEL OPERATION

## FRONT PANEL

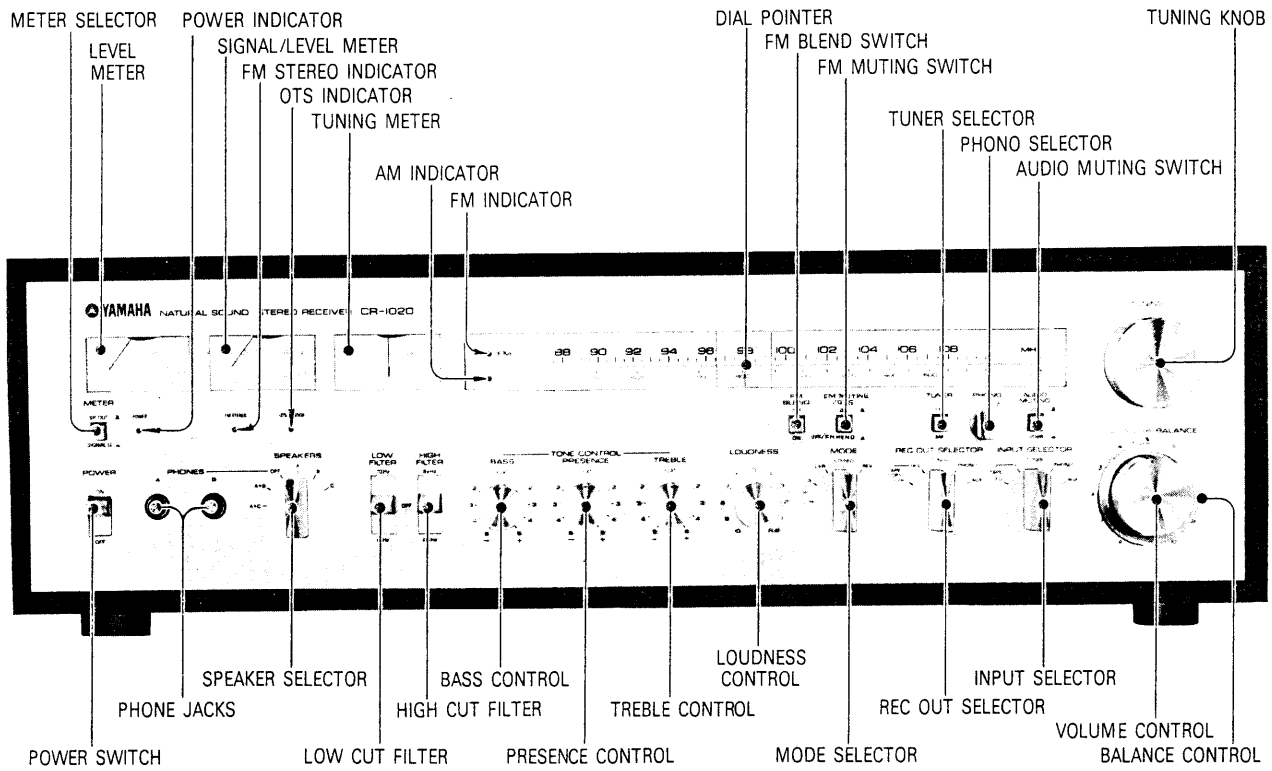

## REAR PANEL GENERAL MODEL

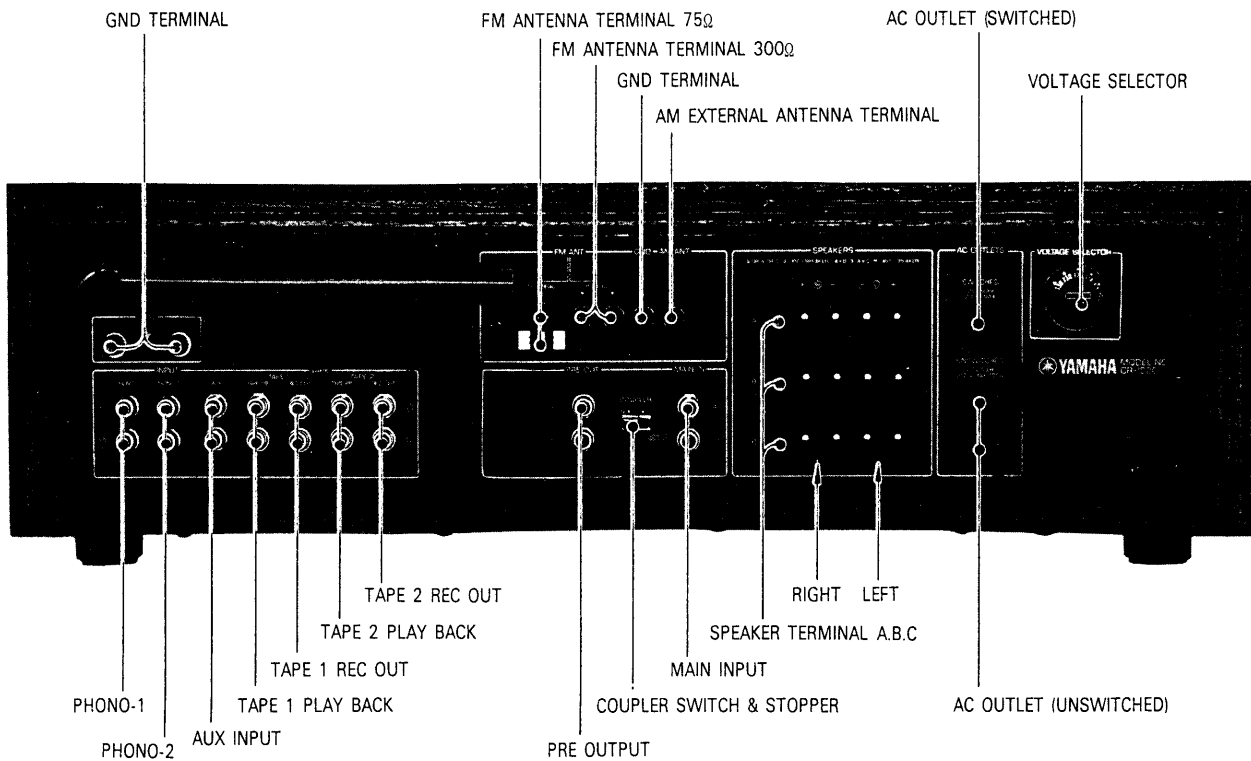

# PANEL OPERATION

## REAR PANEL

### US & CANADIAN MODEL

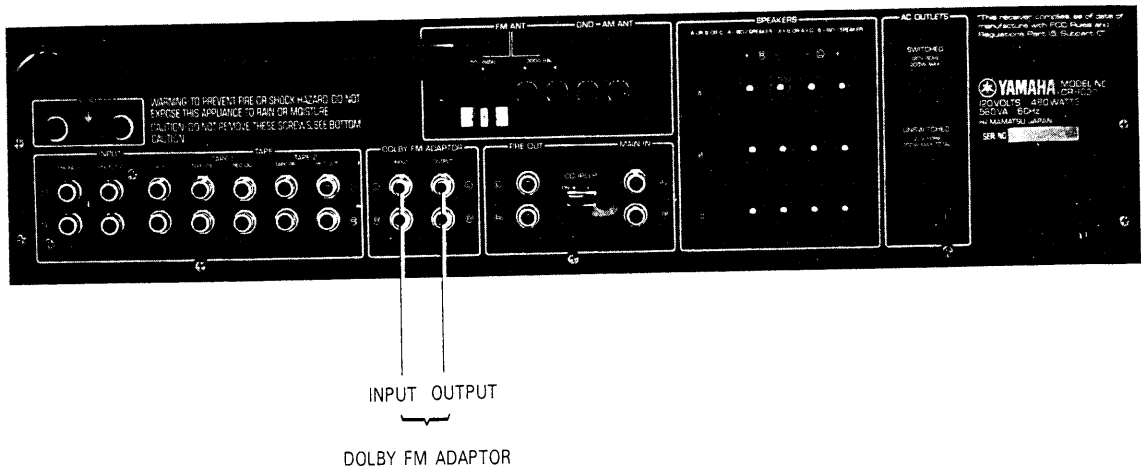

### UK & AUSTRALIAN MODEL

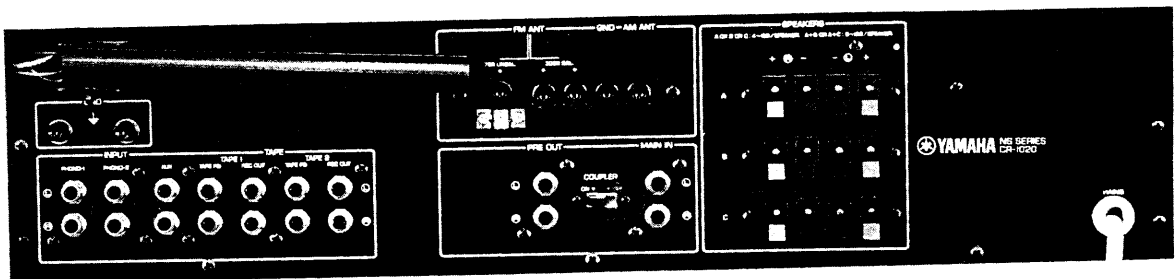

### EUROPEAN MODEL

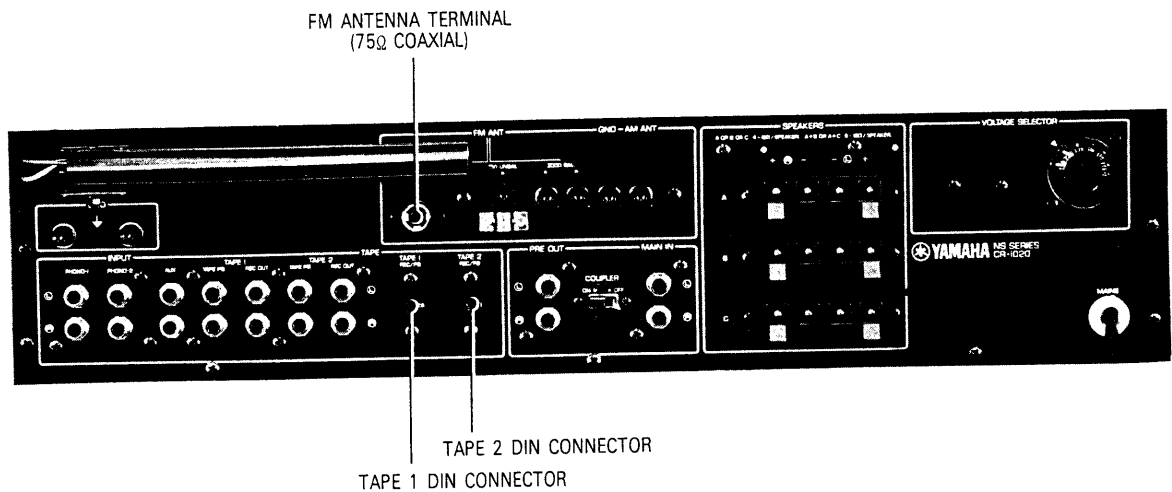

# SPECIFICATIONS

## AMPLIFIER SECTION

### Input Sensivity/Impedance

Phono 1, 2(MM) : 2mV-1kHz/47kΩ, max. 230V  
 AUX, Tape 1, 2 : 120mV/45kΩ  
 DIN 1, 2 : 120V/45kΩ(European model only)  
 Main In : 775mV/100kΩ

### Output Level/Impedance

REC. OUT 1, 2 : 120mV/500Ω(Phono) 6kΩ(Tuner)  
 max. 15V(Phono, 1kHz)  
 DIN OUT 1, 2 : 30mV/52kΩ(European model only)  
 PRE OUT : 775mV (750Ω) max. 5V

### Frequency Response

Phono 1(MM, MC), 2 RIAA Deviation: ±0.2dB  
 AUX, Tape 1, 2 to SP. out: ±2.5dB(10Hz to 100kHz)  
 Main in to SP. out: ±2.5dB(10Hz to 100kHz)

### Tone Control Characteristics

BASS : Turnover 350Hz Variable Range  
 ±15dB/50Hz  
 TREBLE : Turnover 3.5kHz Variable Range  
 ±10dB/20kHz  
 PRESENCE : Center 3kHz 2kHz±6dB

### Filter Characteristics

Low Filter : fc=15Hz, 70Hz 12dB/oct  
 High Filter : fc=8kHz, 12kHz 12dB/oct

### Loudness Characteristics

According to the Fletcher and Munson curve

### Signal-to-Noise Ratio and Noise Level

Phono 1(MM), 2 : (2mV) 81dB (IHF A Network, Input  
 Short Circuited)  
 AUX : 100dB (IHF A Network, 5.1kΩ Short  
 Circuited)  
 Tape : 100dB ( -do.- )  
 Main : 112dB ( -do.- )  
 Residual Noise : 100μV (IHF A Network, Vol. min)

### Total Harmonics Distortion

Phono 1(MM), 2 : 0.01%(20 to 20kHz) REC OUT 7.5V  
 AUX : 0.02%( -do.- ) SP. OUT 50W/8Ω  
 Tape : 0.02%( -do.- ) SP. OUT 50W/8Ω  
 Main In : 0.015%( -do.- ) SP. OUT 50W/8Ω  
 Phono 1(MM), 2 : 0.1%(0.1 to 100W/8Ω) Vol. -20dB  
 IM Distortion AUX: 0.02% SP. OUT 50W/8Ω

### Rating Output and etc.

8Ω Both ch. driven: 70W (20 to 20kHz) 0.05% T.H.D  
 80W (1kHz) 0.05% T.H.D  
 4Ω Both ch. driven: 80W (20 to 20kHz) 0.05% T.H.D  
 (Except E & BS) 90W (1kHz) 0.05% T.H.D  
 Power Band Width: 10 to 50kHz  
 Dumping Factor: 40 or more, 1kHz/8Ω

## TUNER SECTION-FM

### Tuning Range

88 to 108MHz

### Usable Sensitivity. 98MHz

IHF mono : 1.8μV (300Ω) 10.3dBf  
 0.9μV ( 75Ω) 10.3dBf  
 DIN mono : 1.3μV (Dev: 40kHz, S/N: 26dB)  
 stereo : 40μV (Dev: 40kHz, S/N: 46dB)

### 50-dB Quieting Sensitivity

mono : 3.2μV, 15.3dBf  
 stereo : 40μV, 37.2dBf

### Signal-to-Noise Ratio

mono : 77dB, DIN (Dev: 40kHz) 71dB  
 stereo : 73dB, DIN (Dev: 40kHz) 67dB

Image Interference Ratio (98MHz) : 85dB  
 IF Interference Ratio (98MHz): 90dB  
 Spurious Interference Ratio (98MHz): 100dB  
 Amplitude Suppression Ratio IHF: 65dB  
 Capture Ratio: 1dB  
 Alternate-Channel Selectivity : 80dB  
 DIN (Dev: ±300kHz, 40kHz): 60dB

### Total Harmonics Distortion

mono : 100Hz, 0.08%  
 1kHz, 0.08%  
 6kHz, 0.15%  
 stereo : 100kHz, 0.15%  
 1kHz, 0.1%  
 6kHz, 0.2%

### Cross Modulation Distortion

IHF mono : 0.05%  
 stereo : 0.1%

### Stereo Separation

50Hz : 35dB  
 1kHz : 50dB  
 10kHz: 45dB

### Frequency Response

50 to 10kHz : ±0.3dB  
 30 to 15kHz : ±0.5dB  
 10 to 18kHz : +0.5 -3dB

### Sub Carrier Suppression

60dB

### Muting Signal Level

3μV (14.8dBf), 30μV (34.8dBf)

## TUNER SECTION-AM

### Tuning Range

525 to 1605kHz

### Usable Sensitivity (Used Bar antenna)

IHF: 300μV/m (49dB/m)

### Selectivity

1000kHz: 30dB

### Signal-to-Noise Ratio

80dB/m: 50dB

### Image Interference Ratio

1000kHz: 55dB

### IF Interference Ratio

1000kHz: 40dB

### Spurious Interference Ratio

1000kHz: 55dB

### Total Harmonics Distortion

80dB/m: 0.4%

### Output Level/Impedance

FM(Mod. 100%) : 450mV/6.5KΩ(REC OUT)  
 FM(Mod. 30%) : 120mV/6.5KΩ(REC OUT)

## GENERAL

### Used Semi Conductors

109 Transistors 58 Diodes  
 4 ICs 7 Zener Diodes  
 3 FETs 5 LEDs  
 4 CFs

### Rated Voltage

120V/60Hz (US. and CANADA)  
 240V/50Hz, (UK. and AUSTRALIA)  
 110, 120, 130, 220, 230 and 240V/50, 60Hz  
 (EUROPE and General export models)

### Rated Power Consumption

320W, 390VA (US., CANADA and General export models)  
 520W (UK., EUROPE and AUSTRALIA)

### Dimensions

540(W) x 167(H) x 415(D)mm  
 21-1/4 x 6-9/16 x 16-5/16 in (US., CANADA and General  
 export models)  
 521(W) x 146.5(H) x 415(D)mm  
 20-1/2 x 5-3/4 x 16-5/16 in (UK. and EUROPE)

### Weight

18.8kg 41.4 lbs (US., CANADA, AUSTRALIA and  
 General export models)  
 18.6kg 40.3 lbs (UK. and EUROPE)

# CHARACTERISTIC CHARTS

## TUNER SECTION-FM

### DISTORTION V. MODULATING FREQUENCY

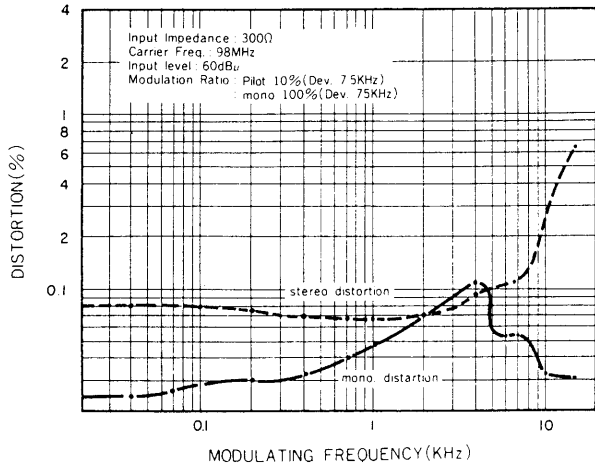

### T.H.D. V. INPUT LEVEL

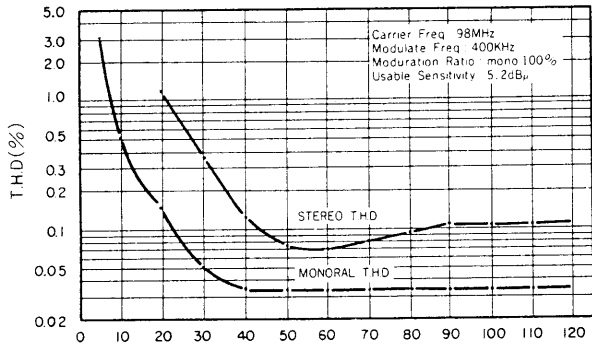

### FM 2 SIGNALS EFFECTIVE SELECTIVITY

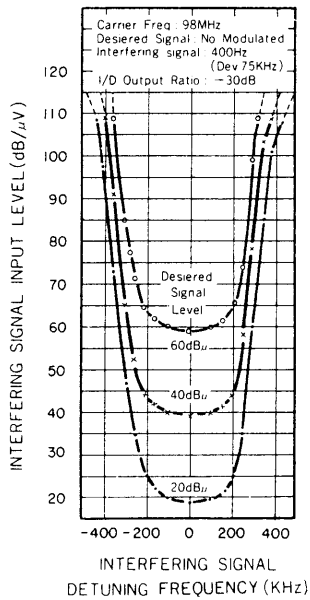

## AMPLIFIER SECTION

### FREQUENCY RESPONSE

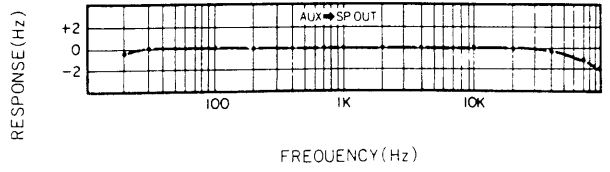

### T.H.D. V. OUTPUT

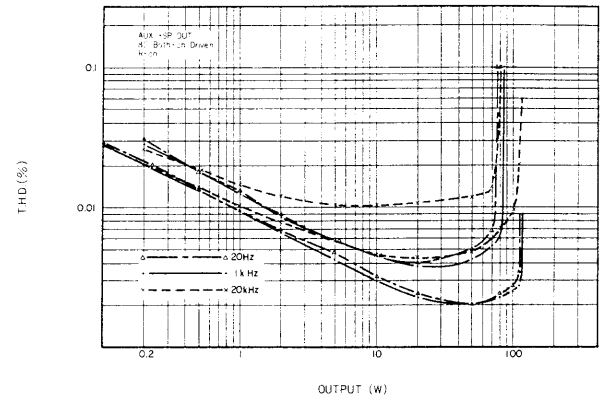

### RIAA DEVIATION

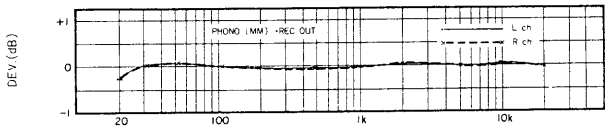

### T.H.D. V. PHONO INPUT

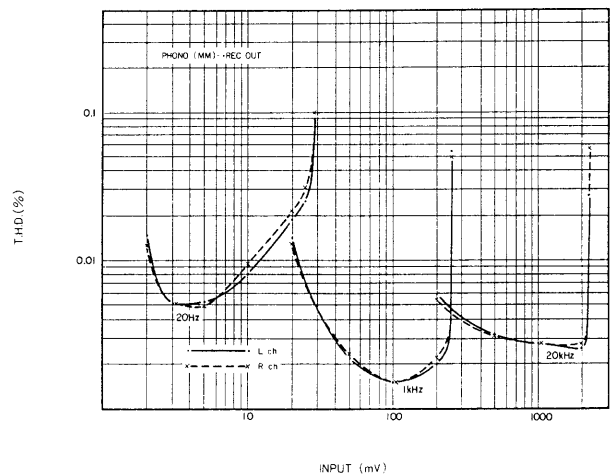

# BLOCK DIAGRAM

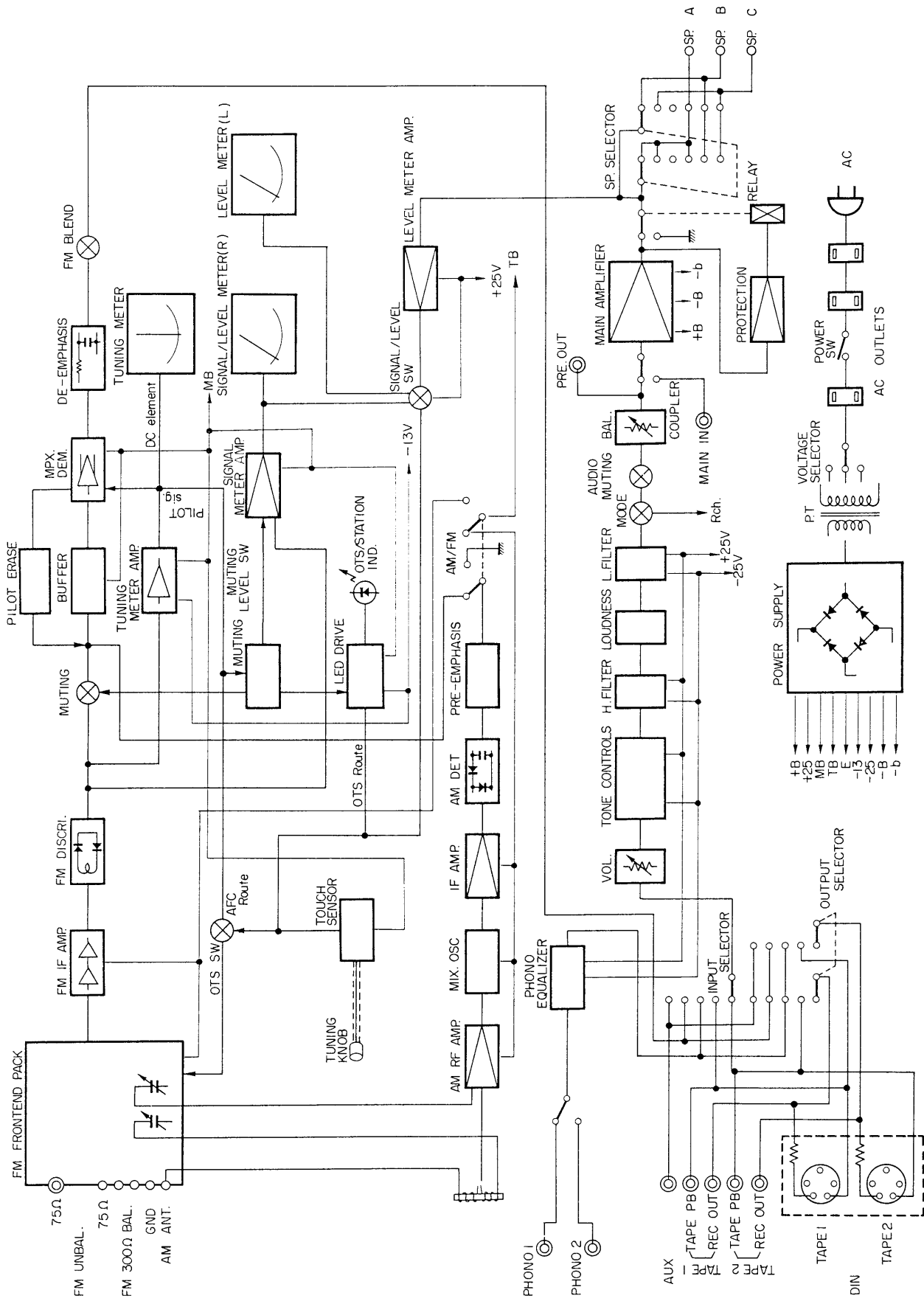

# FLOW CHART FOR DISASSEMBLY PROCEDURES

Disassembly procedures are shown in accordance with U.S. model.

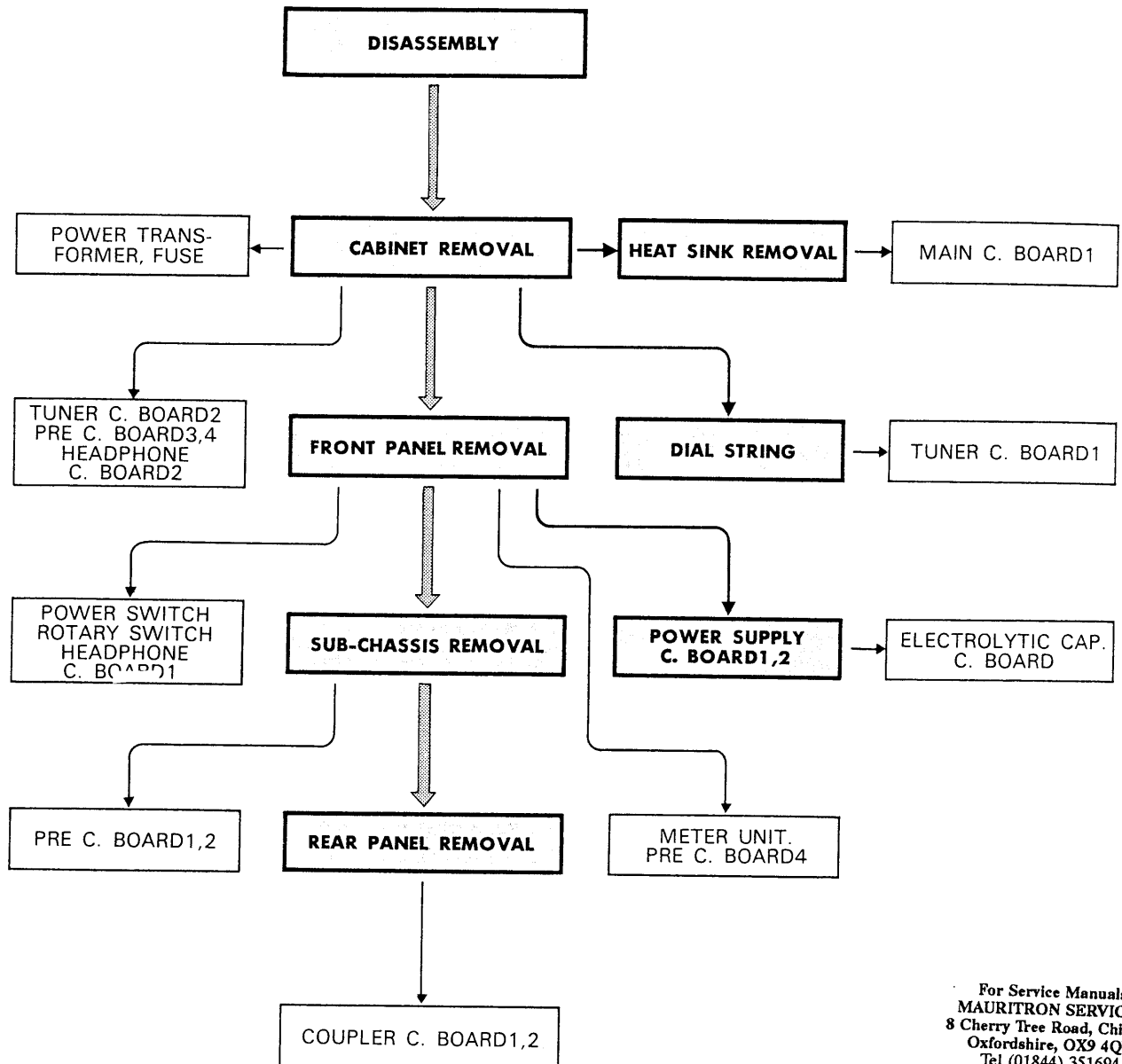

For Service Manuals  
**MAURITRON SERVICES**  
 8 Cherry Tree Road, Chinnor  
 Oxfordshire, OX9 4QY.  
 Tel (01844) 351694  
 Fax (01844) 352554  
 email:- sales@mauritron.co.uk

## Note

**TUNER C. BOARD 2:**

**PRE C. BOARD 1:**

**PRE C. BOARD 2:**

**PRE C. BOARD 3:**

**HEADPHONE C. BOARD 1:**

**HEADPHONE C. BOARD 2:**

**COUPLER C. BOARD 1:**

**COUPLER C. BOARD 2:**

**POWER SUPPLY C. BOARD 2:**

FM BLEND, FM MUTING, OTS AND AM-FM SWITCHES

LOW AND HIGH FILTER SWITCHES, TONE AND LOUDNESS CONTROLS,  
 MODE, REC OUT AND INPUT SELECTORS

VOLUME AND BALANCE CONTROLS

AUDIO MUTING SWITCH

HEADPHONE JACKS

AM-FM INDICATORS

ANTENNA TERMINALS

COUPLER SWITCH AND PIN JACKS

METER SELECTOR



## DISASSEMBLY PROCEDURES

### 1. CABINET REMOVAL

Remove 5 screws, then pull out the chassis in arrow direction.

Since the cabinet used for UK and European models are different from the photo shown below, refer to "EXPLODED VIEW" as shown in page 1 of the PARTS LIST.

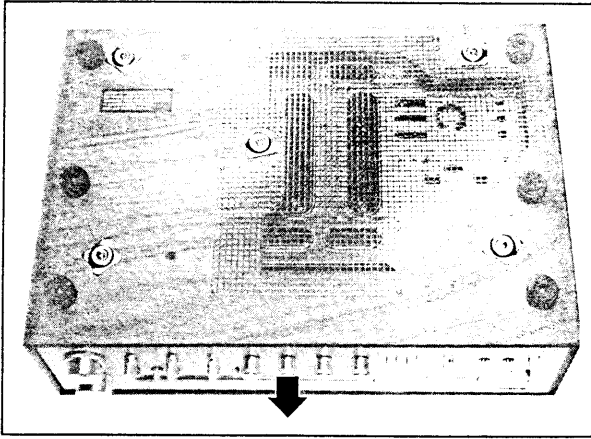

Step 2. Remove 4 screws fixing 2 power transistors.

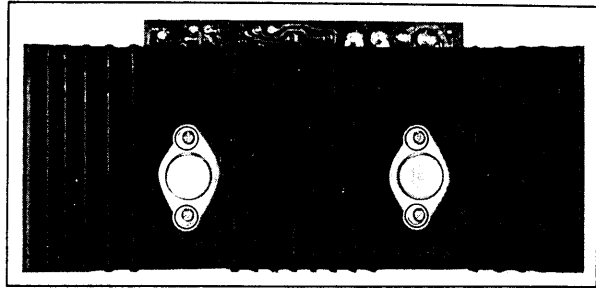

### 4. HEADPHONE CIRCUIT BOARD 2 REMOVAL

Remove a plastic rivet, then detach the Headphone Circuit Board 2 from dial scale.

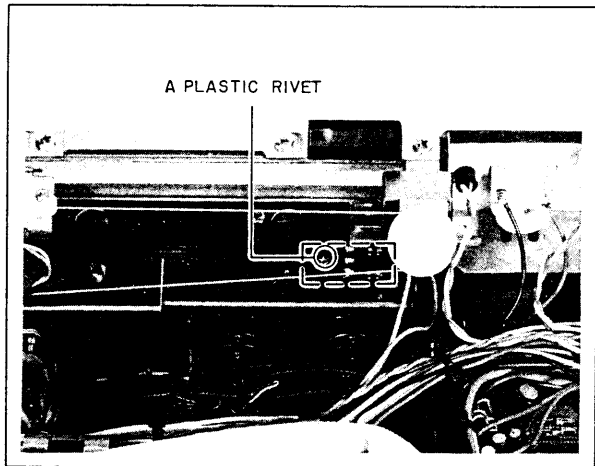

### 2. POWER TRANSFORMER REMOVAL

Remove 4 screws.

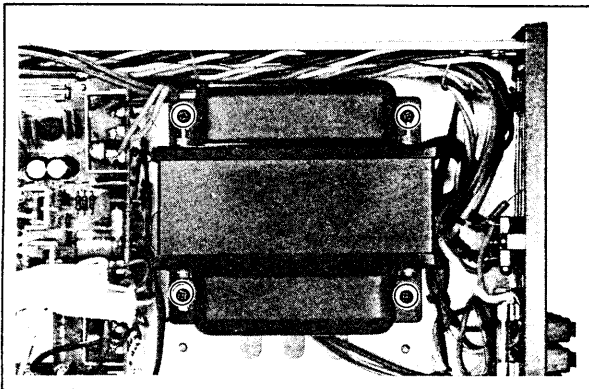

### 3. HEAT SINK AND MAIN CIRCUIT BOARD 1 REMOVAL

Step 1. Remove 4 screws, then dismantle the heat sink.

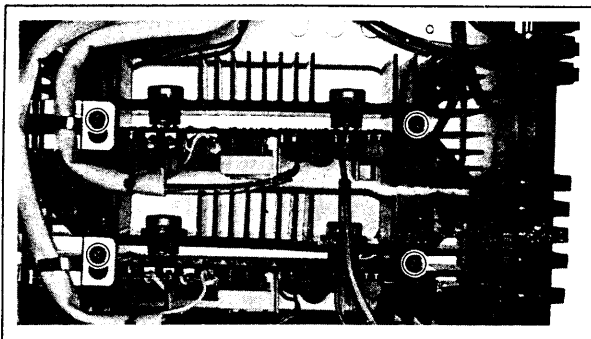

### 5. PRE CIRCUIT BOARD 3 AND TUNER CIRCUIT BOARD 2 REMOVAL

Screw A is for fixing the Pre Circuit Board 3.

Screws B are for fixing the Tuner Circuit Board 2.

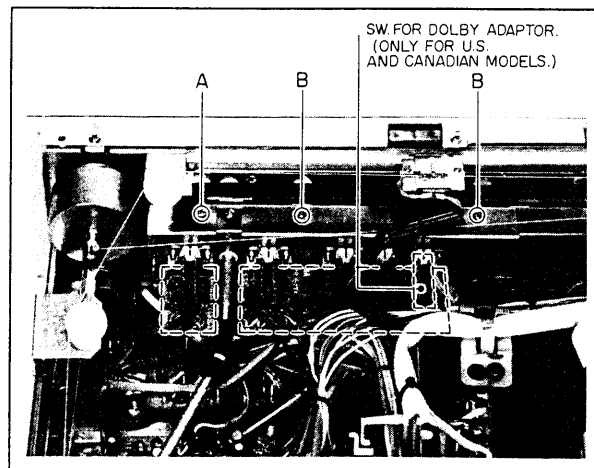

## DISASSEMBLY PROCEDURES

### 6. FRONT PANEL REMOVAL

- Step 1.** 1) Remove 3 screws 1 to 3, and pull off 7 knobs **A** to **G**.
- 2) Insert a hexagonal allen wrench in arrow direction and loosen 2 screws fixing the tuning knob, then withdraw the knob.

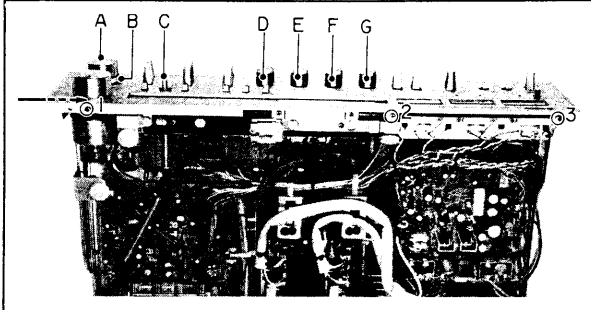

- Step 2.** 1) Remove 4 screws 1 to 4.
- 2) Loosen 4 screws **A** to **D** fixing each knob with a hexagonal allen wrench, then withdraw the knobs.

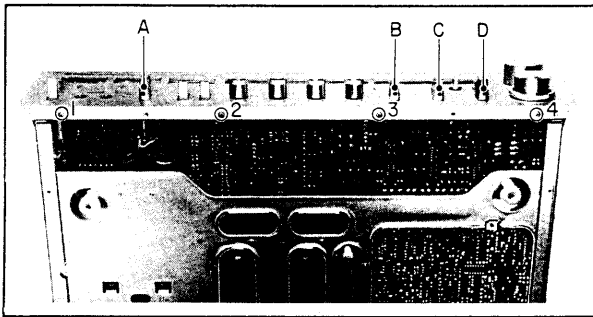

### 7. POWER SUPPLY CIRCUIT BOARD 1 REMOVAL

Remove 2 screws, then pull off the Power Supply Circuit Board 1 in arrow direction.

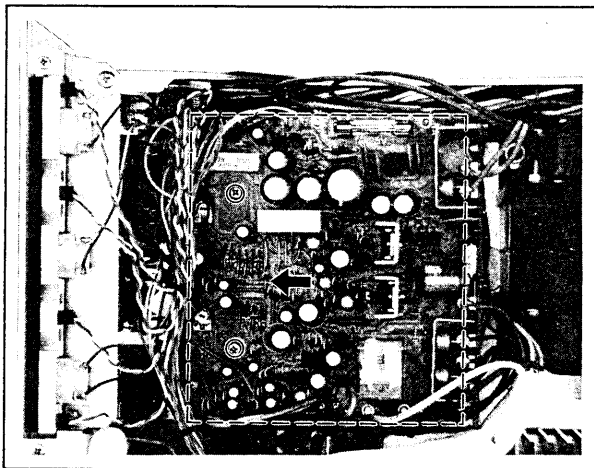

### 8. POWER SUPPLY CIRCUIT BOARD 2 REMOVAL

Remove a screw.

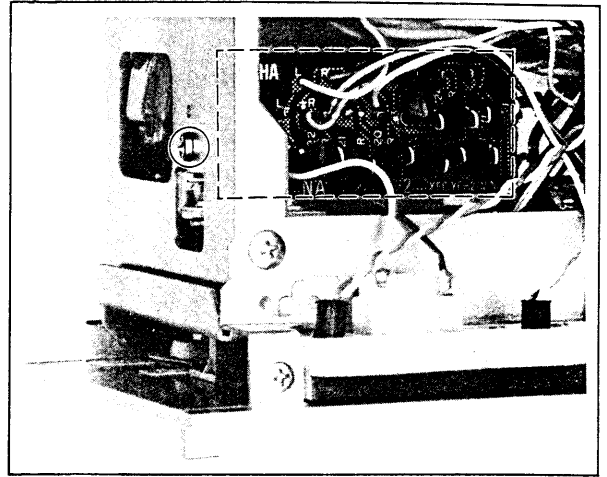

### 9. ELECTROLYTIC CAPACITOR CIRCUIT BOARD REMOVAL

- 1) Remove 2 screws, then dismantle the holder securing 2 electrolytic capacitors.
- 2) Slide up the Electrolytic Capacitor Circuit Board in arrow direction.

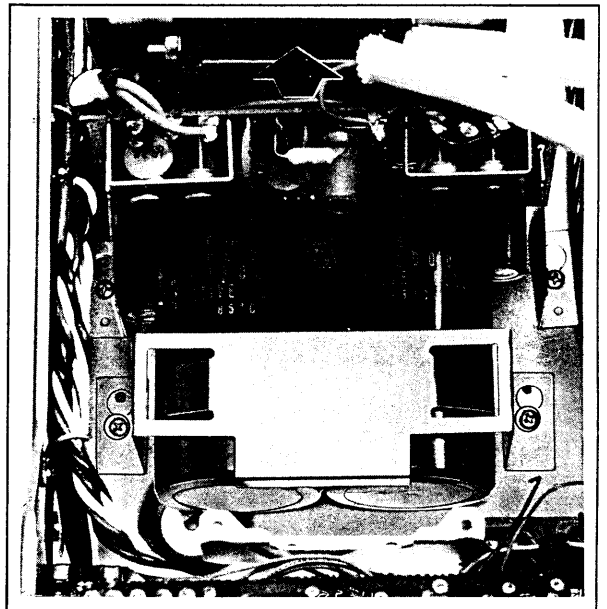

## DISASSEMBLY PROCEDURES

### 10. POWER SWITCH, HEADPHONE CIRCUIT BOARD 1 AND ROTARY SWITCH REMOVAL

- 1) Pull off the knob of the power switch.
- 2) Remove 2 screws and 3 hexagonal nuts.

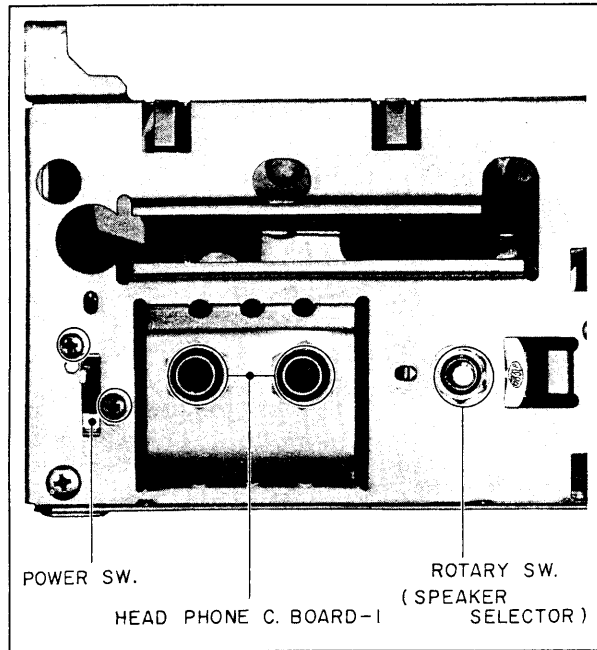

### TOP VIEW

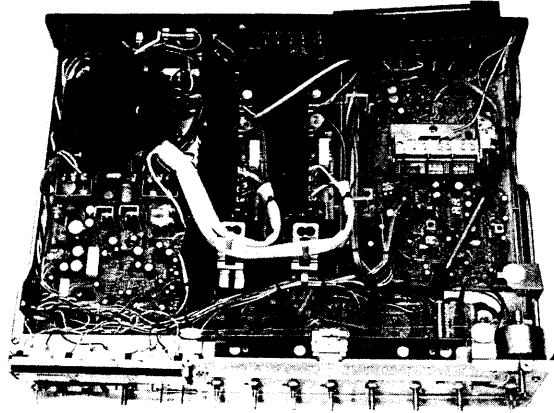

### BOTTOM VIEW

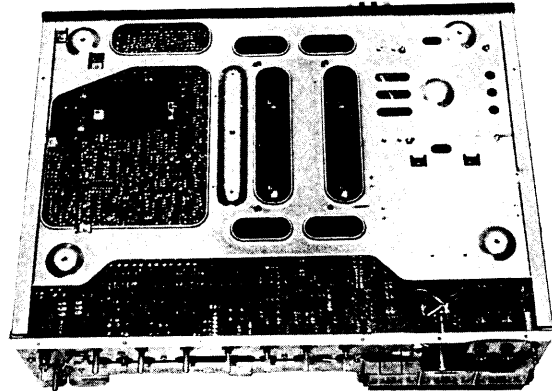

### 11. SUB-CHASSIS REMOVAL

- 1) Pull the knobs off.
- 2) Remove 8 screws and 9 hexagonal nuts.

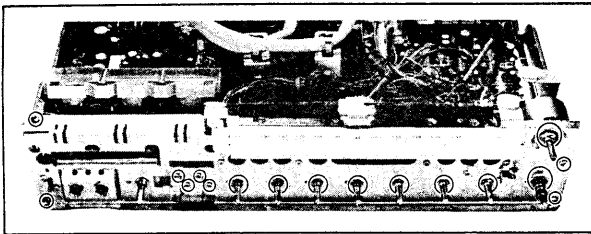

### 12. REAR PANEL REMOVAL

Remove 9 screws.

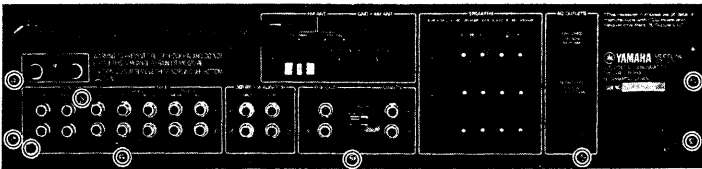

# DIAL CORD STRINGING

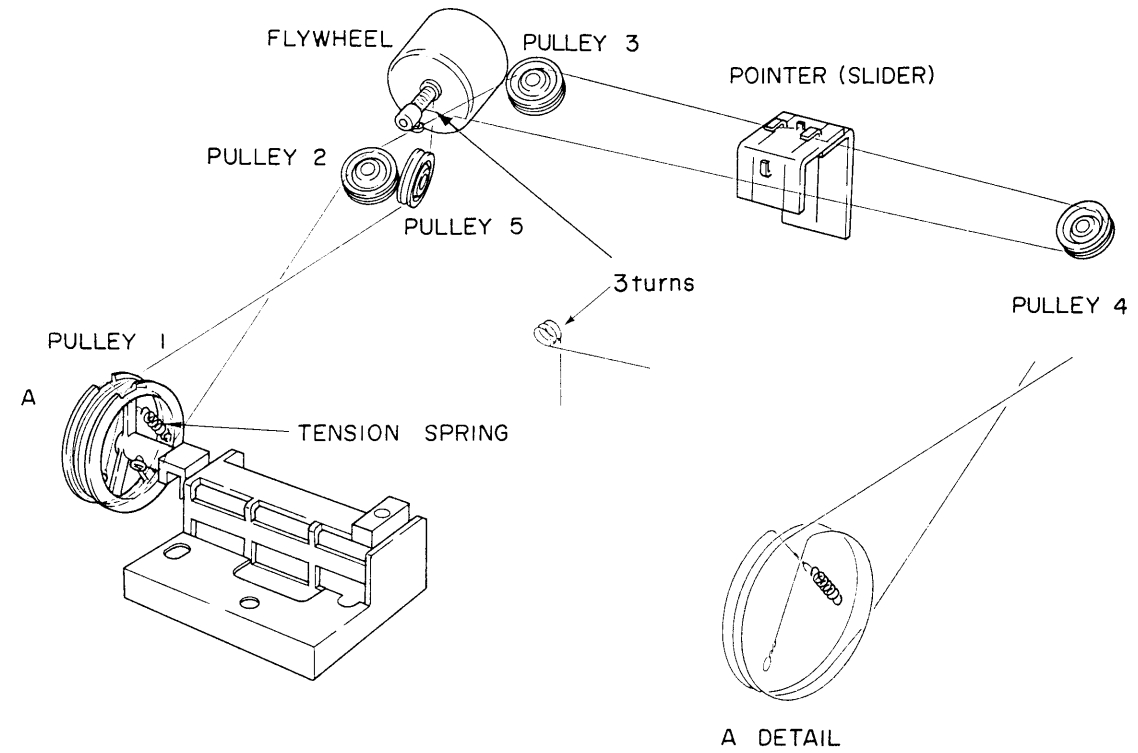

DIAL CORD LENGTH

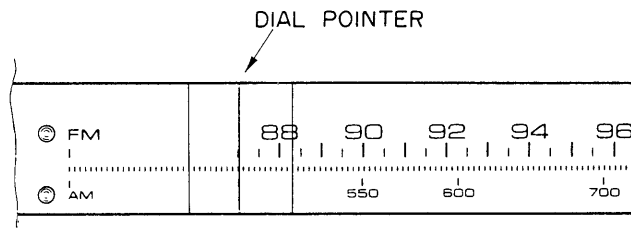
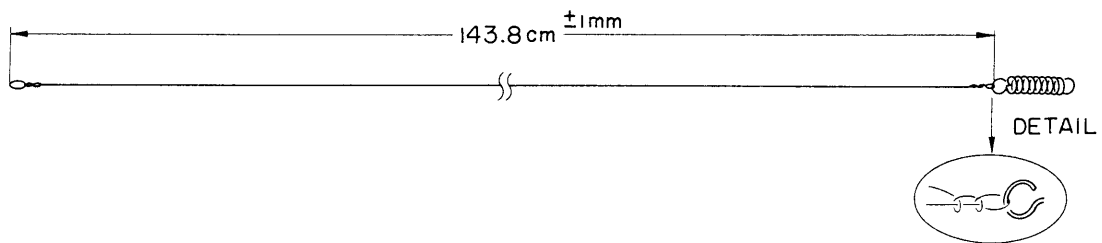

LOW END

After stringing the dial cord, turn the tuning knob fully counterclockwise and set the pointer to lower end indication of the scale as illustrated above. Then hook the string to the pointer assembly and lock by painting.

# ADJUSTMENT

## ADJUSTMENT OF LEVEL METER

### ADJUSTING POINTS

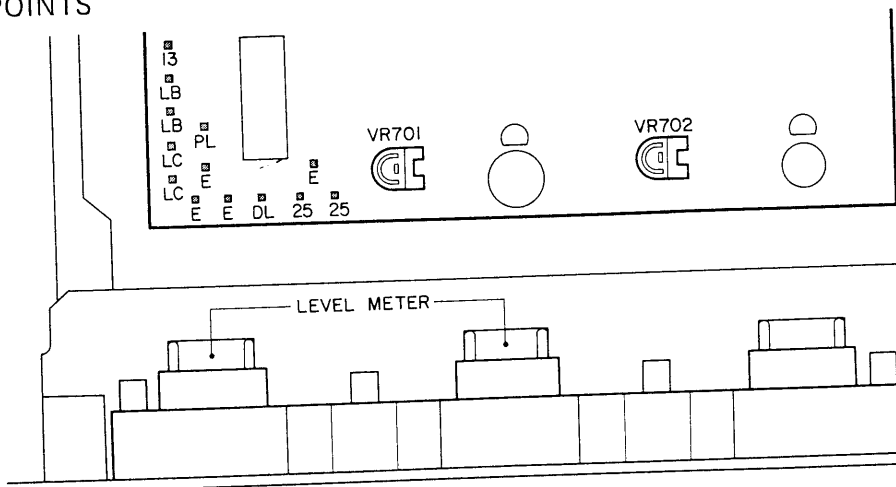

ITEM	ADJUSTING POINTS	CONNECTING POINT	EQUIPMENT	METHOD	INDICATION
LEVEL METER	VR-701 VR-702	—	50W/8Ω (1kHz)	Turn VR-701, 702 so that the wattage becomes rated value as shown on right hand side.	50W (±1m/m)

## ADJUSTMENT OF MAIN C.BOARD

### ADJUSTING POINTS

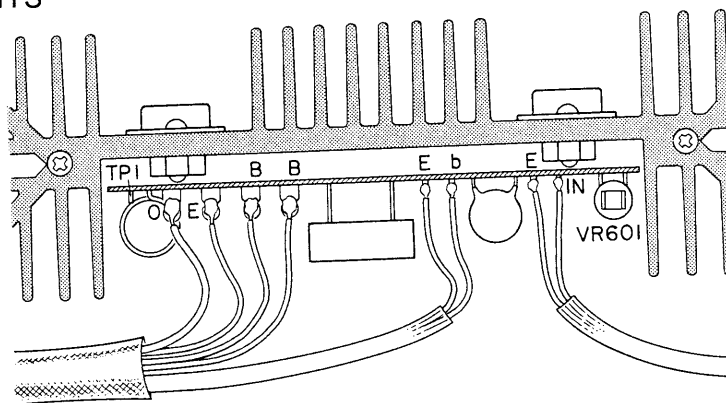

## ADJUSTMENT OF IDLING CURRENT

ITEM	ADJUSTING POINT	CONNECTING POINT	EQUIPMENT	METHOD	INDICATION
IDLING CURRENT	VR-601	TP1 - 0	VTVM or Digital Volt Meter	Turn VR601, so that the voltage between TP1 and TP0 becomes rated value as shown on right hand side.	10±1mV

# ADJUSTMENT

## ADJUSTMENT OF TUNER C.BOARD ADJUSTING POINTS

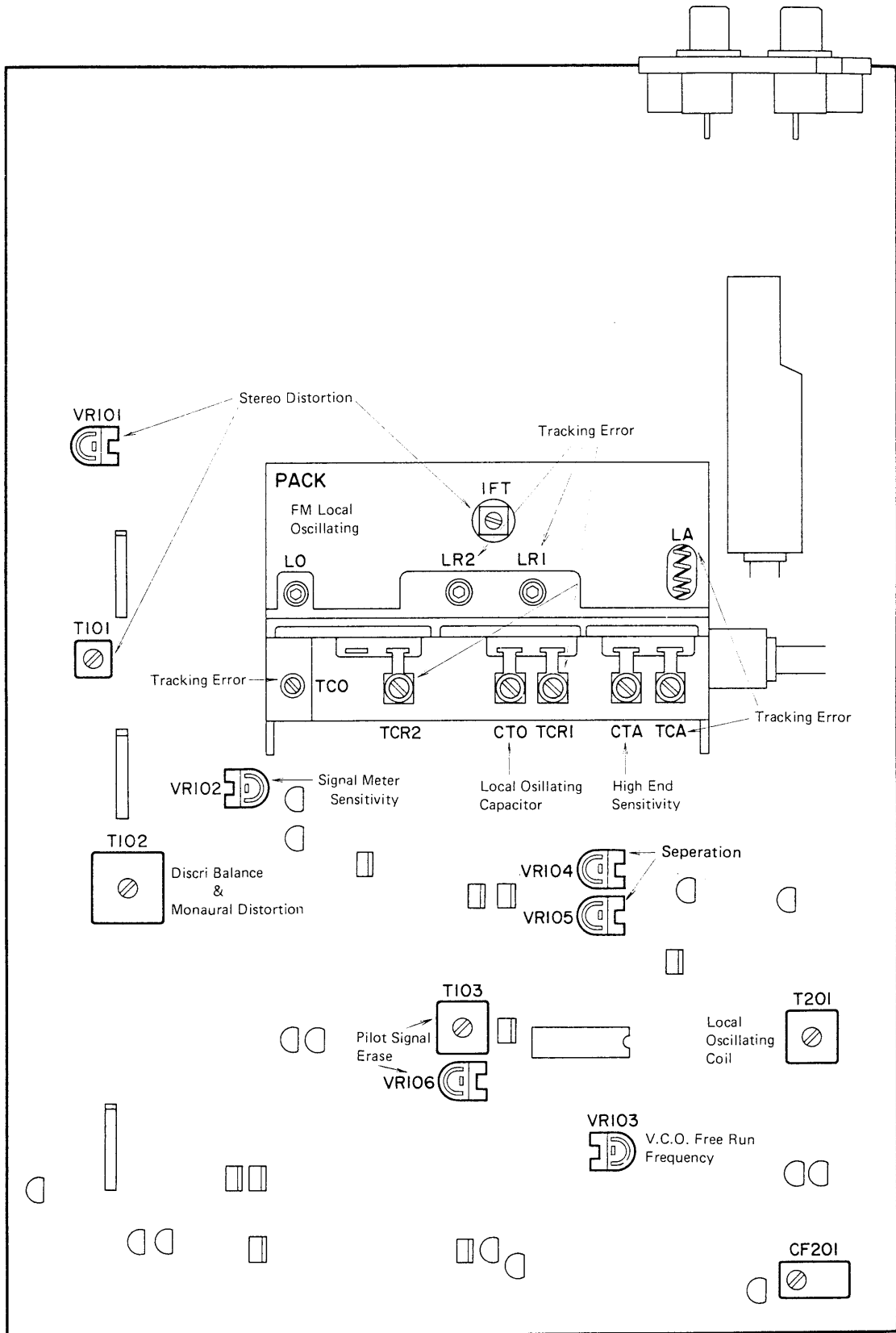

## ADJUSTMENT

### ADJUSTMENT OF TRACKING ERROR OF FM SECTION

Step	ITEMS	ADJUSTING POINTS	CONNECTING INPUT	EQUIPMENT	METHOD	RE-MARKS
1	POINTER OF THE DIAL	Pointer	FM Ant.	FM SG 98MHz 60dB $\mu$	Tune the receiver to SG, then loosen the pointer from the dial string and set the pointer to 98MHz of the scale.	$\pm 1$ mm or less
2	HIGH END TRACKING ERROR CONFIRMATION		FM Ant.	FM SG 108MHz 60dB $\mu$	Tune the receiver to SG, then confirm so that the pointer is on 108MHz of the scale.	$\pm 2$ mm or less
3	TRACKING ERROR TRIMMING (Only when proper confirmation cannot be made by step 2, proceed to step 3.)	Pointer	FM Ant.	FM SG 88MHz to 108MHz 60dB $\mu$	Reset the pointer, so that the pointer is on within allowance in all range as shown on right hand side.	$\pm 2$ mm or less
4	TRACKING ERROR ADJUSTING (Only when proper adjustment cannot be made by step 3, proceed step 4.)	TCO (Pack)	FM Ant.	FM SG 98MHz 108MHz 60dB $\mu$	Adjust error by the pointer and TCO alternately. 98MHz – pointer 108MHz – TCO	

### ADJUSTMENT OF TRACKING ERROR OF AM SECTION

ADJUST AM SECTION AFTER ADJUSTMENT OF FM SECTION MADE CORRECTLY.

Step	ITEMS	ADJUSTING POINTS	CONNECTING POINTS	EQUIPMENT	METHOD	RE-MARKS
1	LOCAL OSCILLATING COIL	T201	Bar Ant.	AM SG 600kHz 80dB/m to 100dB/m	Set the pointer to 600kHz of the scale, then turn the core of T201 slowly, so that the signal meter swings to the maximum.	
2	LOW END SENSITIVITY	Core of bar ant.	Bar Ant.	AM SG 600kHz 60dB/m	Turn the cord of the bar antenna coil, so that the signal meter swings to the maximum.	
3	LOCAL OSCILLATING CAPACITOR	CT0 (Pack)	Bar Ant.	AM SG 1350kHz 80dB/m to 100dB/m	Set the pointer to 1350kHz of the scale, then turn the trimmer capacitor CT0, so that the signal meter swings to the maximum.	
4	HIGH END SENSITIVITY	CTA (Pack)	Bar Ant.	AM SG 1350kHz 60dB/m	Turn the trimmer capacitor CTA, so that the signal meter swings to the maximum.	
5	REPEAT			AM SG 600kHz 1350kHz 60dB/m	The above adjustments are necessary to repeat 2 to 3 times to minimize tracking error and differential of sensitivity between 600kHz and 1350kHz.	Tracking error: $\pm 1.5$ mm or less
6	MID RANGE CONFIRMATION		Bar Ant.	AM SG 950kHz	Tune the receiver to SG, so that the signal meter swings to the maximum, then confirm so that the pointer is on 950kHz of the scale.	$\pm 2$ mm or less

# ADJUSTMENT

## ADJUSTMENT OF TUNER CIRCUIT BOARD

Step	ITEMS	ADJUST- ING POINT	CON- NECTING INPUT	POINT OUTPUT	EQUIPMENT	METHOD	INDI- CATION (Typical)
1	DISCRI. BALANCE	T102 (up-side core)	FM Ant.			Turn the pointer to detuning point near by 98MHz, and turn the up-side core of the T102 so that the tuning meter reads zero. Note: Before adjusting, confirm that the meter reads zero when the power SW. is off.	0(zero)
2	TUNING POINT SETTING	Tuning knob	FM Ant.		FM SG 98MHz 60dB $\mu$	Tune the knob so that the tuning meter reads center.	
3	VCO FREE RUN FREQUENCY	VR103	FM Ant.	19kHz TP	FM SG -do.- 0% (mod.) Frequency Counter (FC.)	Adjust VR103 so that FC. reads 19kHz. Confirm that FM SG is set to mono.	19kHz $\pm$ 20Hz ( $\pm$ 5Hz)
4	MONAURAL DISTORTION	T 102 (bottom- side core)	FM Ant.	Output (L or R)	-do.- FM SG mono. 1kHz 100%	Turn the bottom-side core of the T102 so that the distortion becomes minimum.	-60dB or less (-64dB)
5	STEREO DISTORTION	T101 VR 101 IFT (Pack)	FM Ant.	Output (L)	FM SG 98MHz 60dB $\mu$ L+R stereo 1kHz 100%  Oscilloscope VTVM Distortion Meter (DM.) LPF (17kHz)	Turn the core of the T101 IFT (Pack), and adjust VR101 so that the distortion becomes minimum.	-56dB or less (-62dB)
6	SEPARATION	VR 104 VR 105	FM Ant.	Output (L, R)	same as step 5 (except DM)	Adjust VR104 (SEP. BAL) so that the both separations of L to R and R to L become approximately equal, then adjust VR105 (SEP.) so that the separation becomes to the maximum. These adjustments should be repeated two or three times.	50dB or more (55dB)
7	PILOT SIGNAL ERASE	VR106 T103	FM Ant.	Output (L, R)	FM SG 98MHz 60dB $\mu$ stereo (MD) pilot: 9%	Connect VTVM and OSC to the Output terminal, and adjust VR 106 and T 103 so that carrier level becomes minimum.	60dB or more (both ch.)
8	SIGNAL METER SESITIVITY	VR102	FM Ant.		FM SG 98MHz 80dB $\mu$ 0%	Adjust VR 102 so that the signal meter swings 90.	90





# CIRCUIT BOARDS

## TUNER C.B.OARD-1 (Tuner)

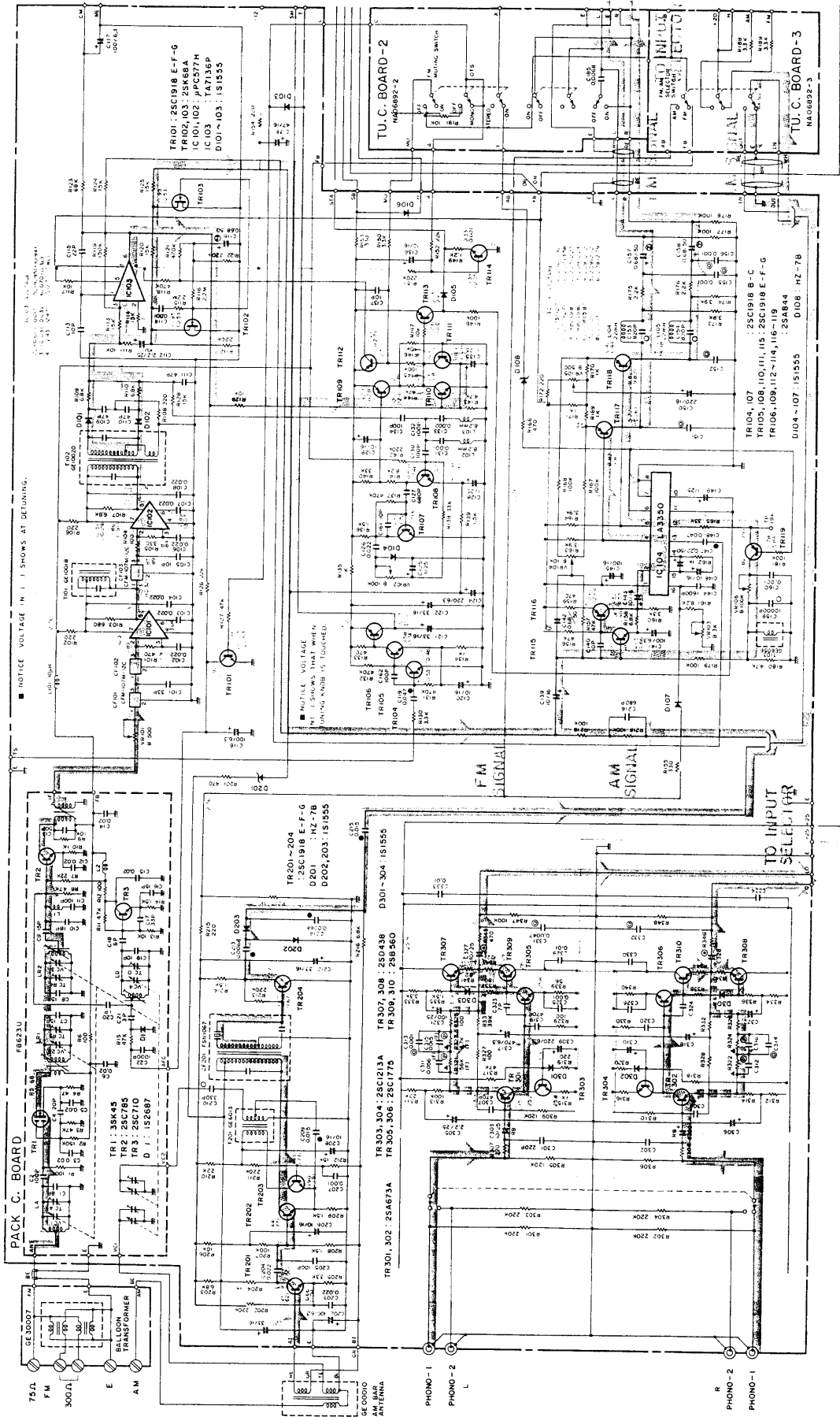

# CIRCUIT BOARDS

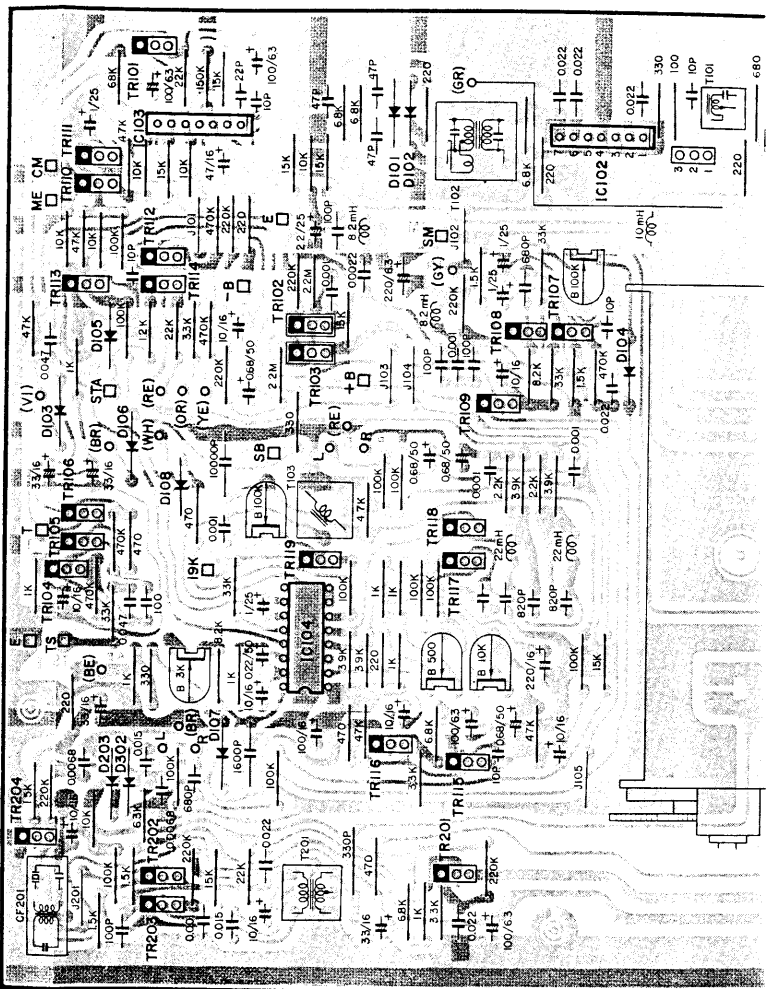
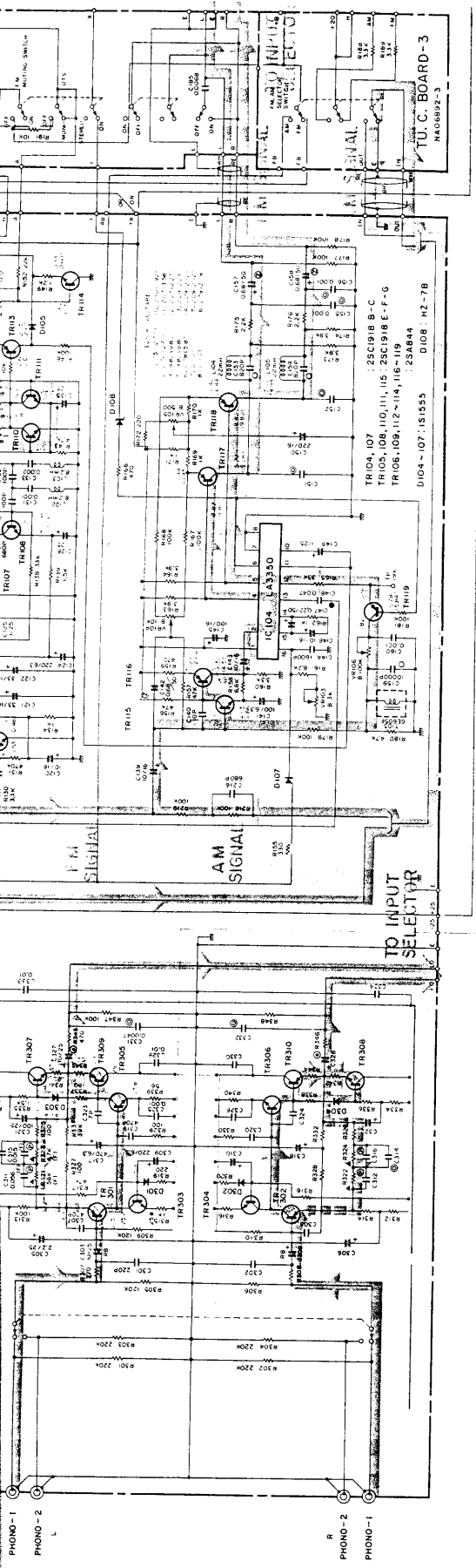

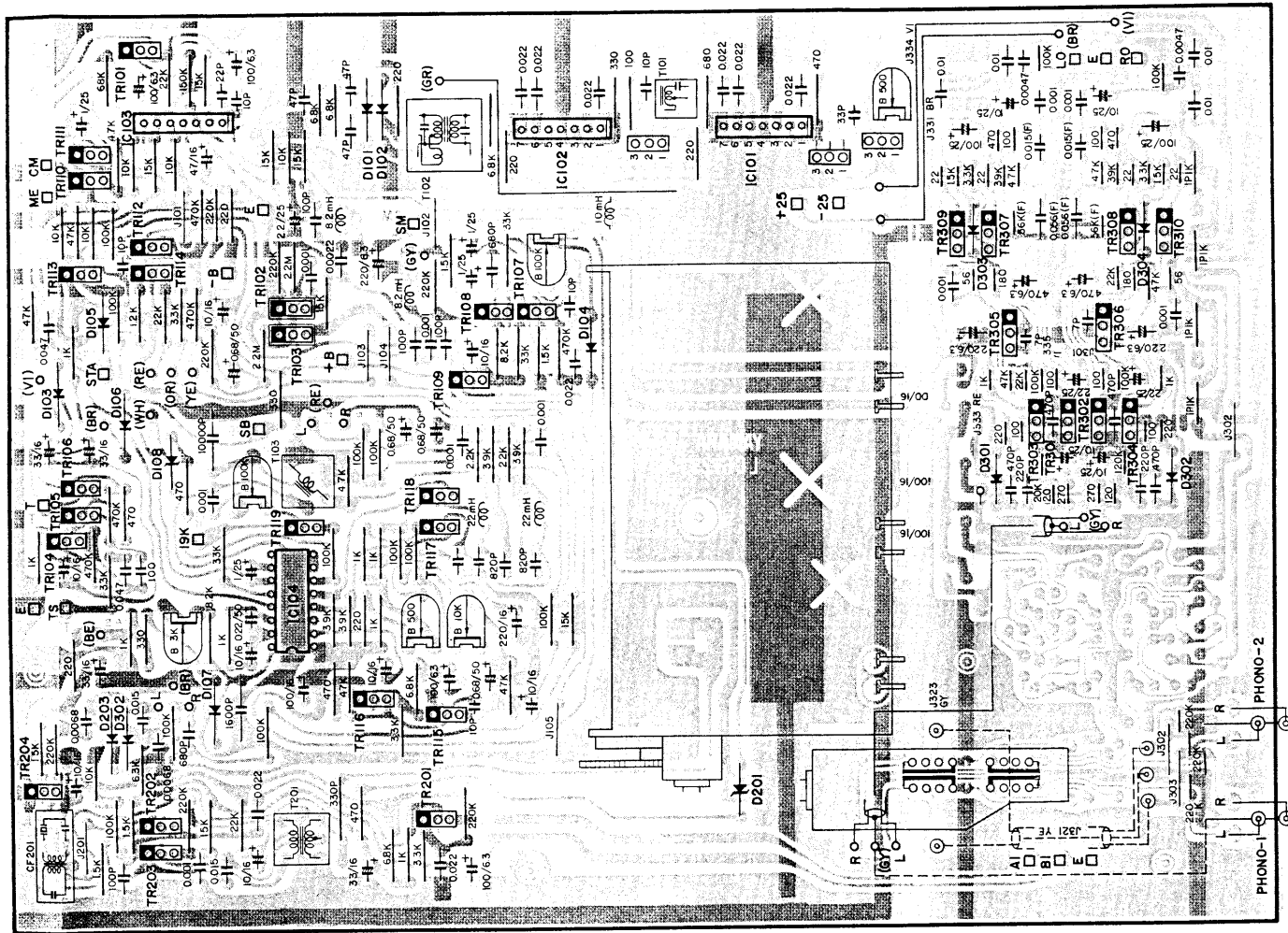

# CIRCUIT BOARDS

## PRE C.BOARD-1,2 (Equalizer and Tone Control Amp.)

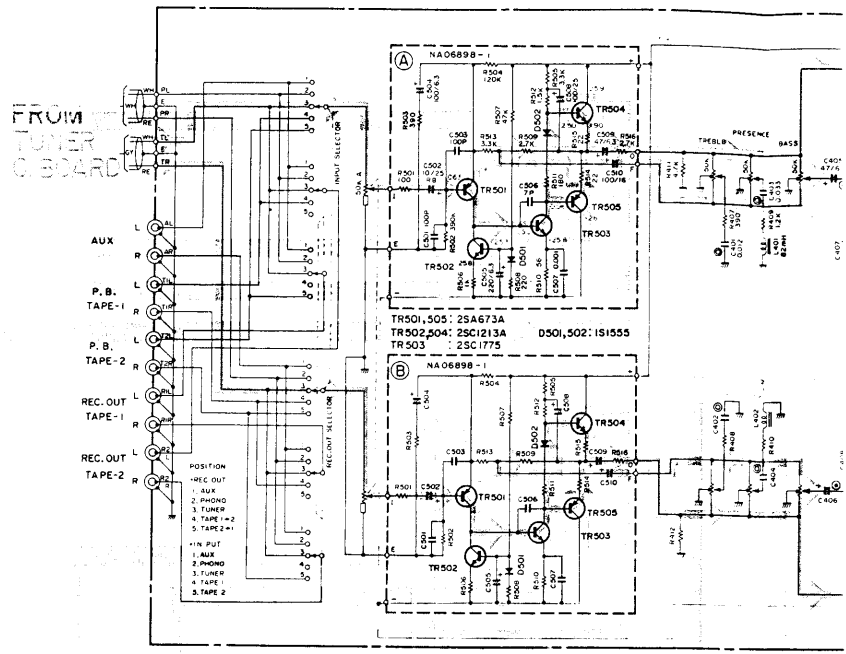

PRE MODULE C. BOARD  
A ~ E

-A-

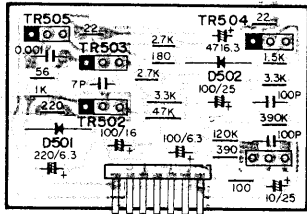

-B-

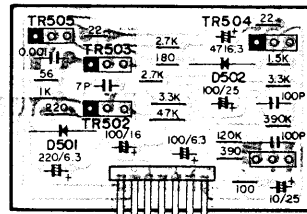

-C-

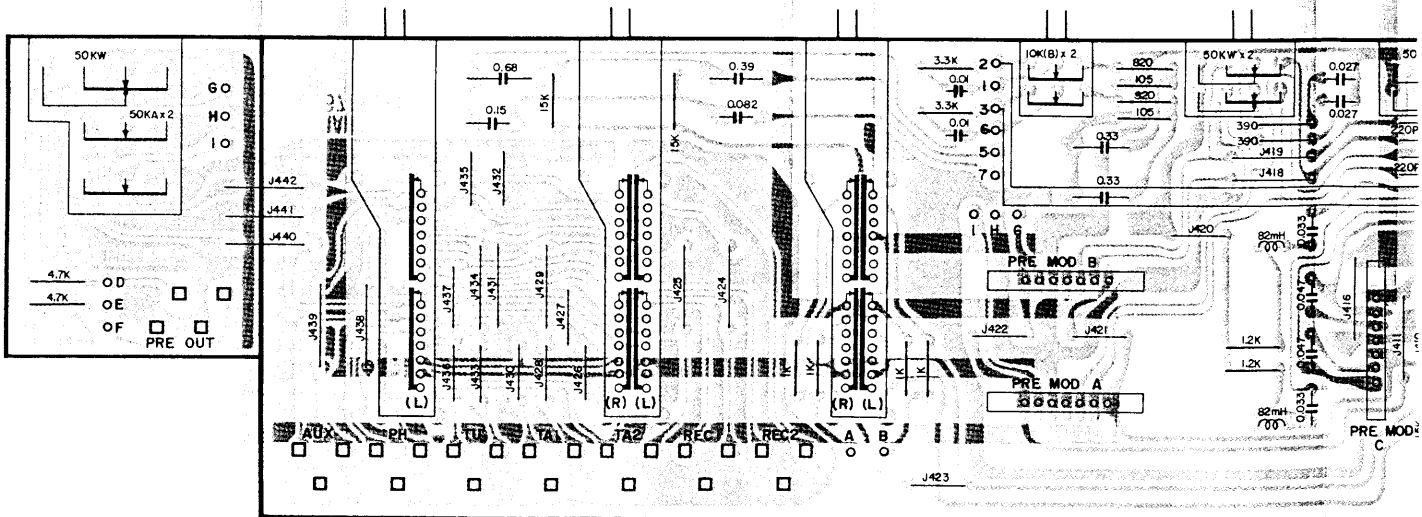
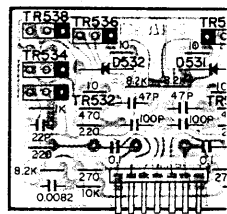

# CIRCUIT BOARDS

(one Control Amp.)

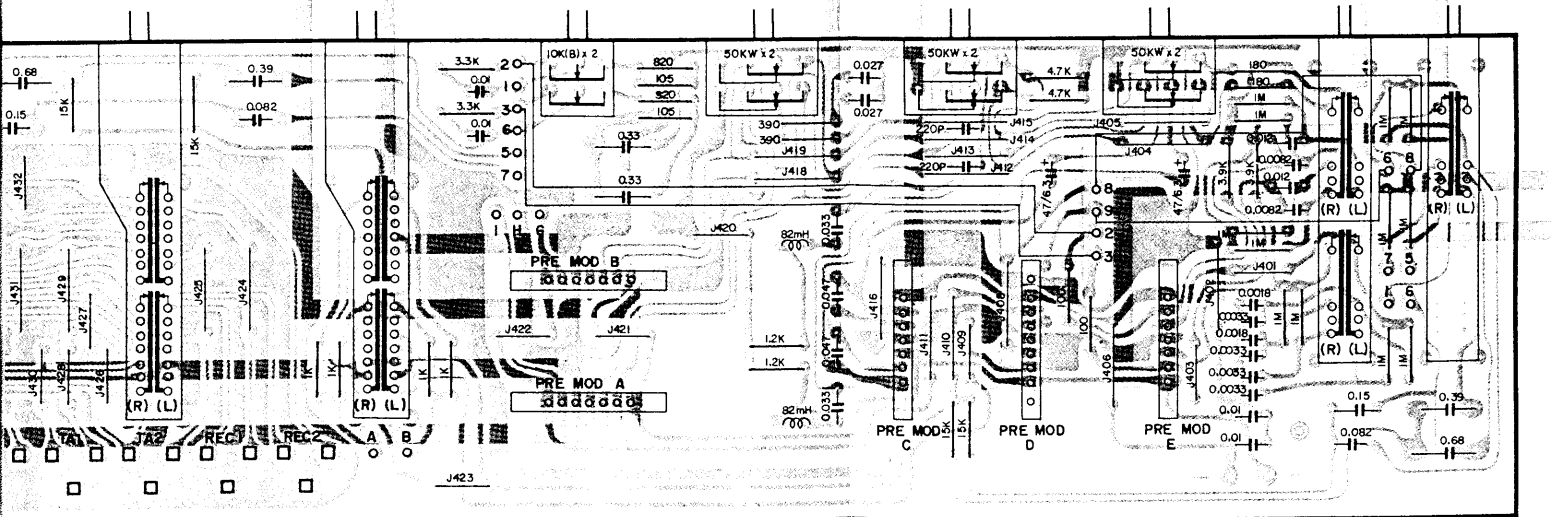
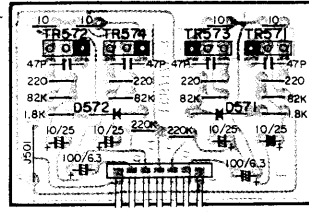
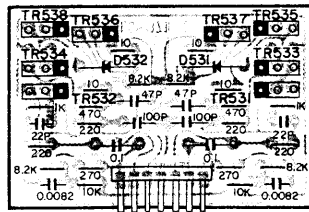
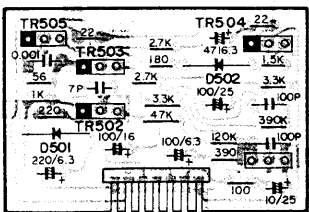
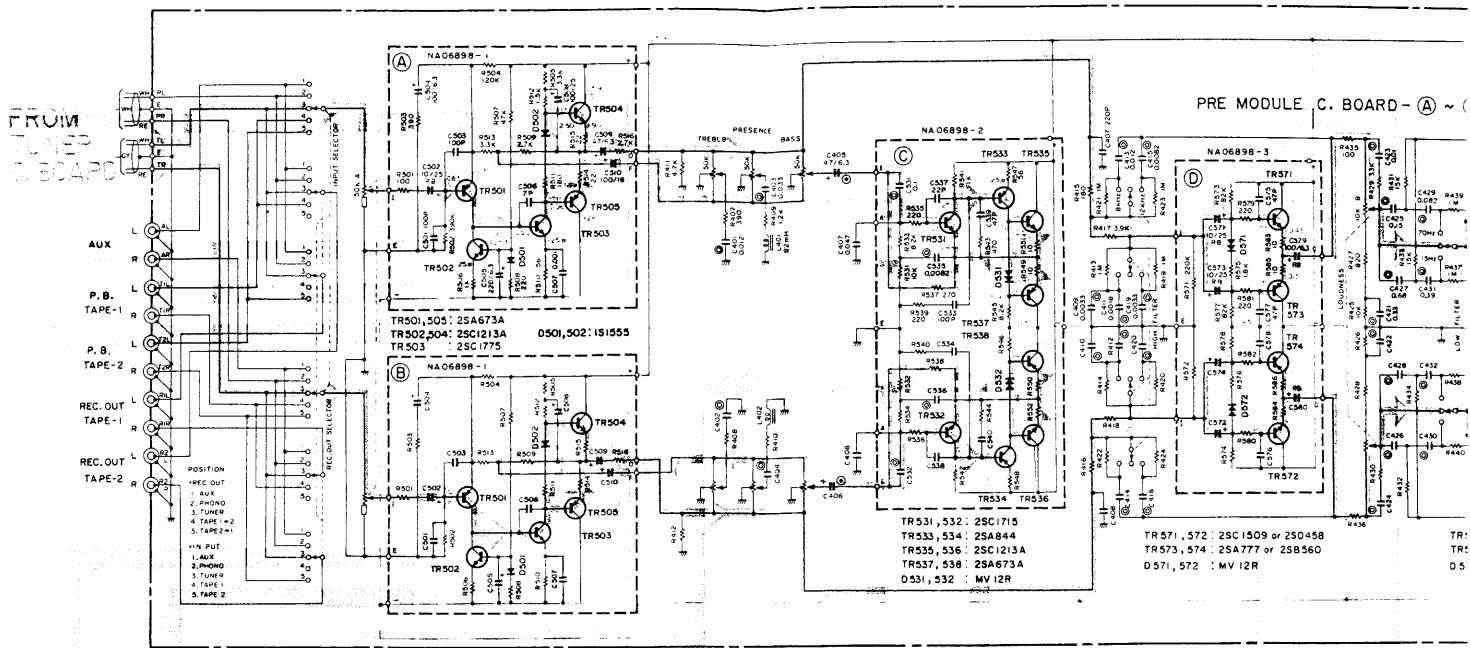

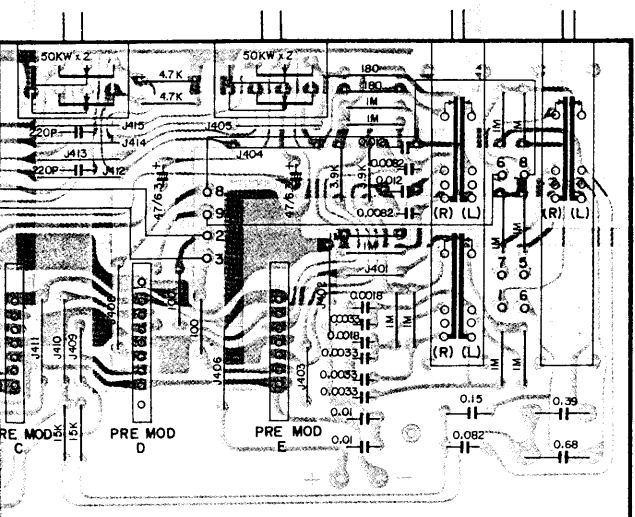
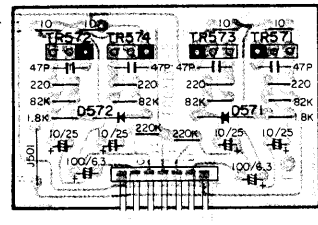
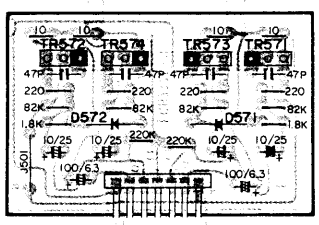
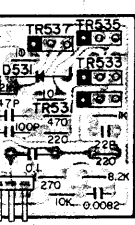
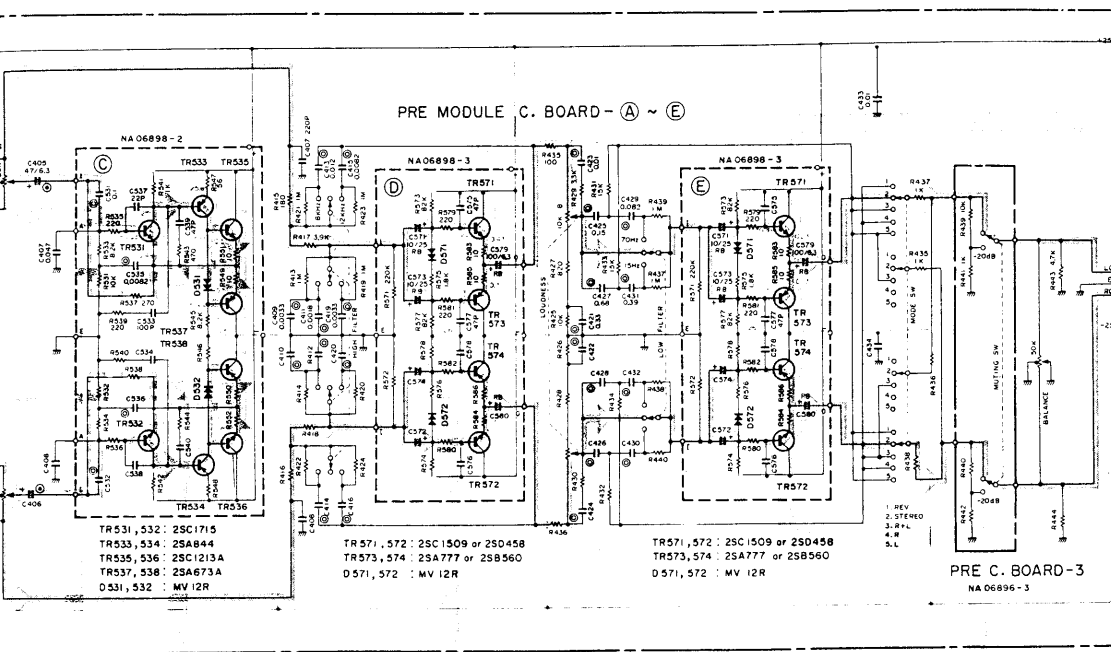

# CIRCUIT BOARDS

## MAIN C.BOARD

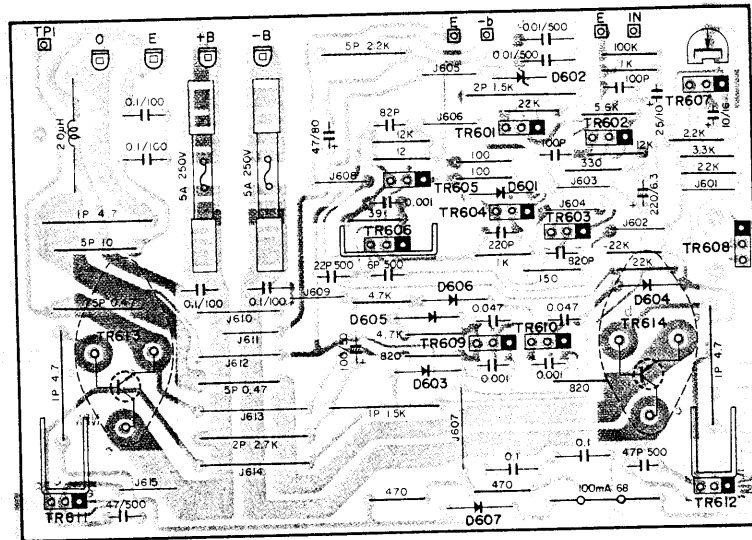
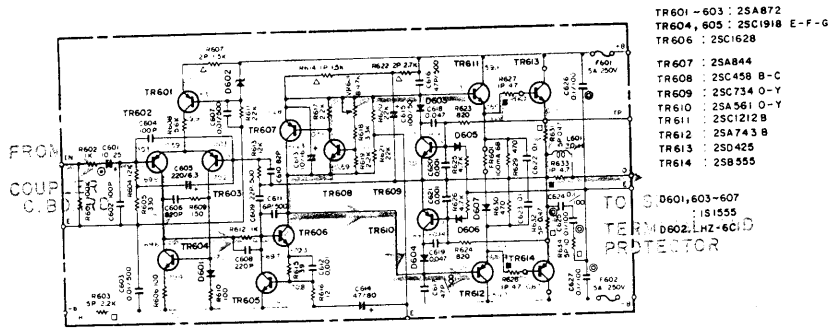

## POWER SUPPLY C.BOARD-2

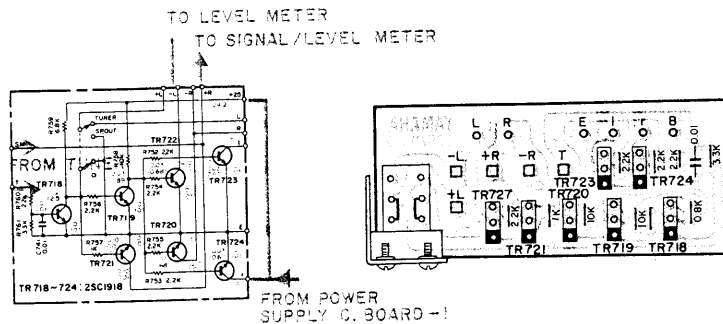

For Service Manuals  
**MAURITRON SERVICES**  
 8 Cherry Tree Road, Chinnor  
 Oxfordshire, OX9 4QY.  
 Tel (01844) 351694  
 Fax (01844) 352554  
 email:- sales@mauritron.co.uk



# CIRCUIT BOARDS

## ELECTROLYTIC CAP. C. BOARD

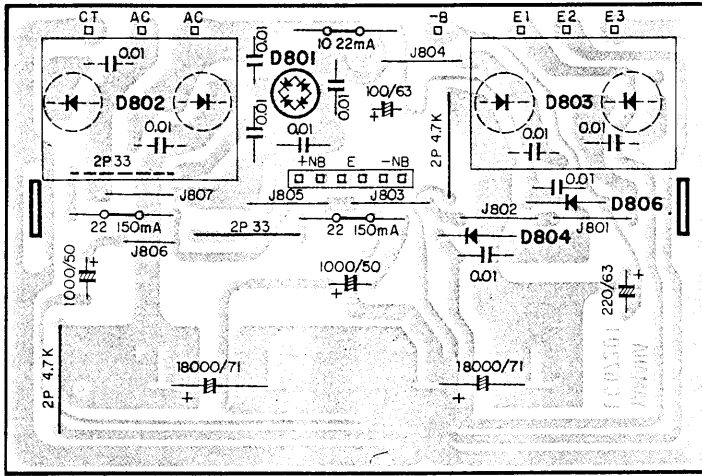

## COUPLER C.BOARD-1

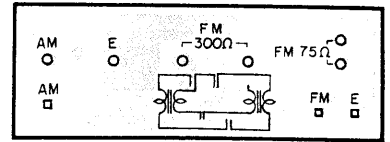

## COUPLER C.BOARD-2

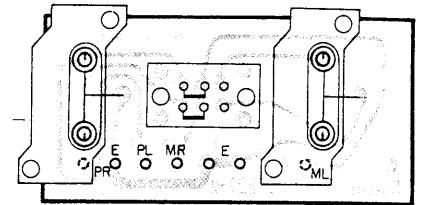

## PRE C.BOARD-3

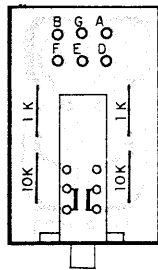

## PRE C.BOARD-4

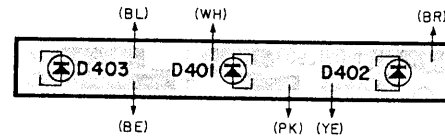

## TUNER C.BOARD-2. -3

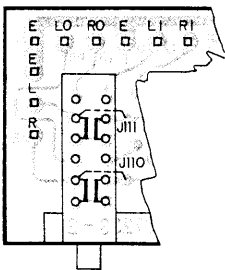

←  
(Only for  
US. and  
Canadian  
models.)

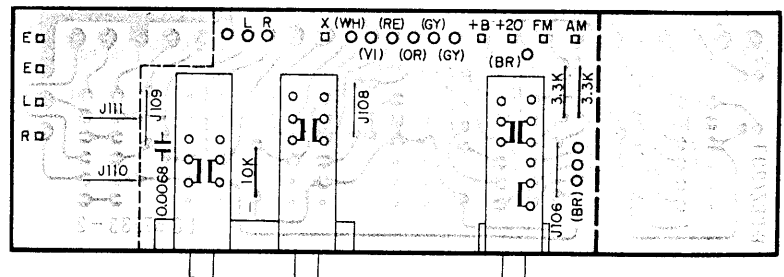

## HEAD PHONE C.BOARD-1

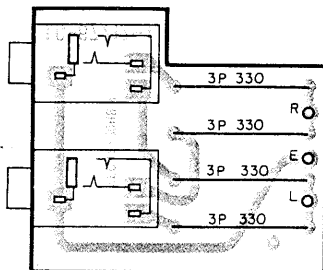

## HEAD PHONE C.BOARD-2

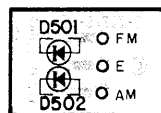

## DIN C.BOARD (Only for European models)

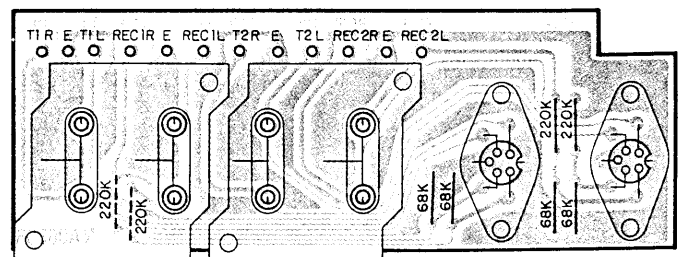

# PACKAGE

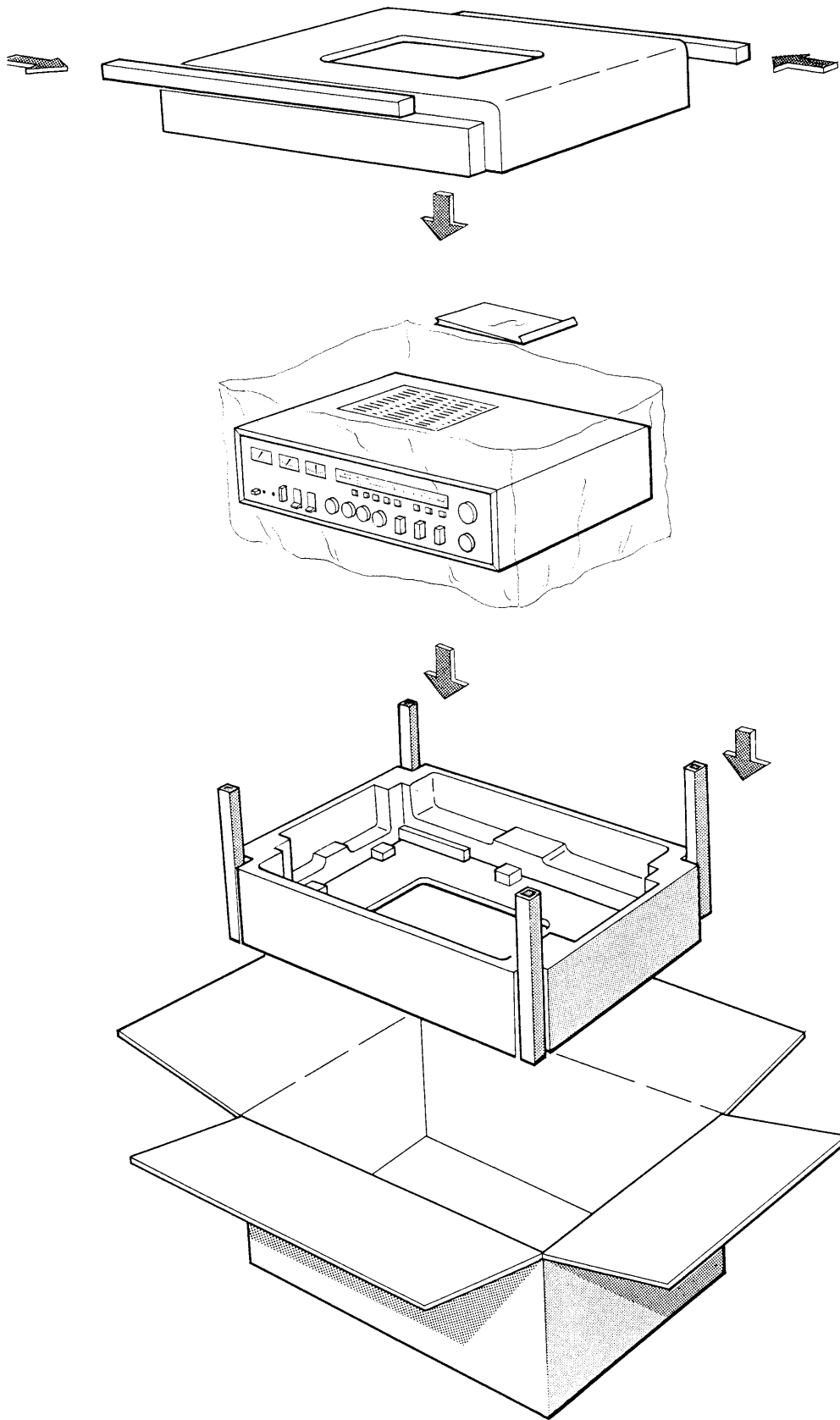

# SCHEMATIC DIAGRAM BY EXPORT ZONE

## POWER SUPPLY CIRCUIT

GENERAL EXPORT model

EUROPEAN model

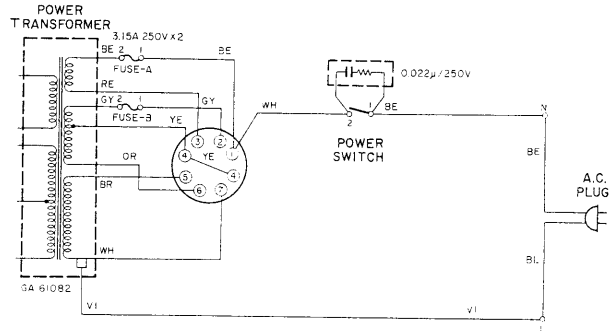
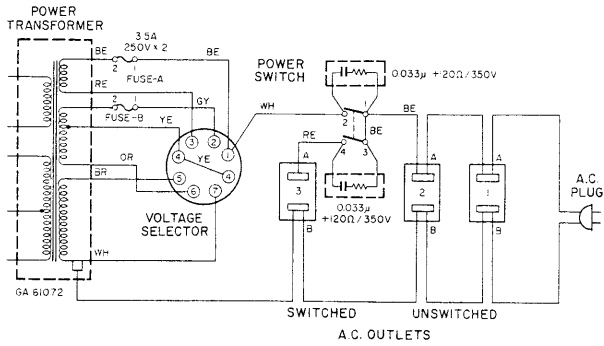

US & CANADIAN model

AUSTRALIAN model

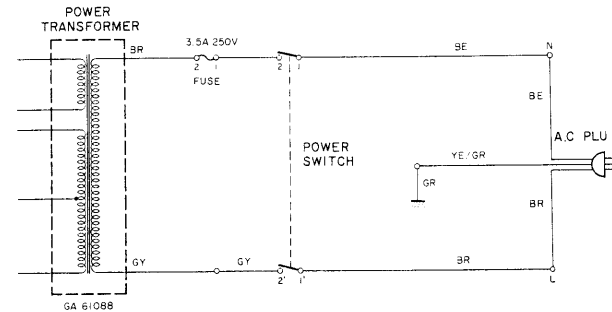
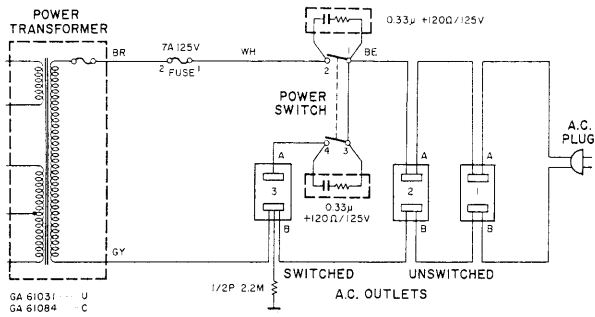

UK model

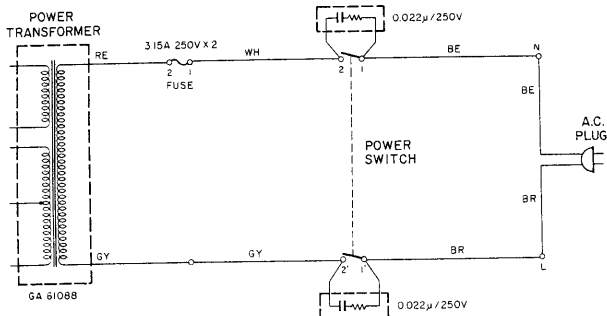

# SCHEMATIC DIAGRAM

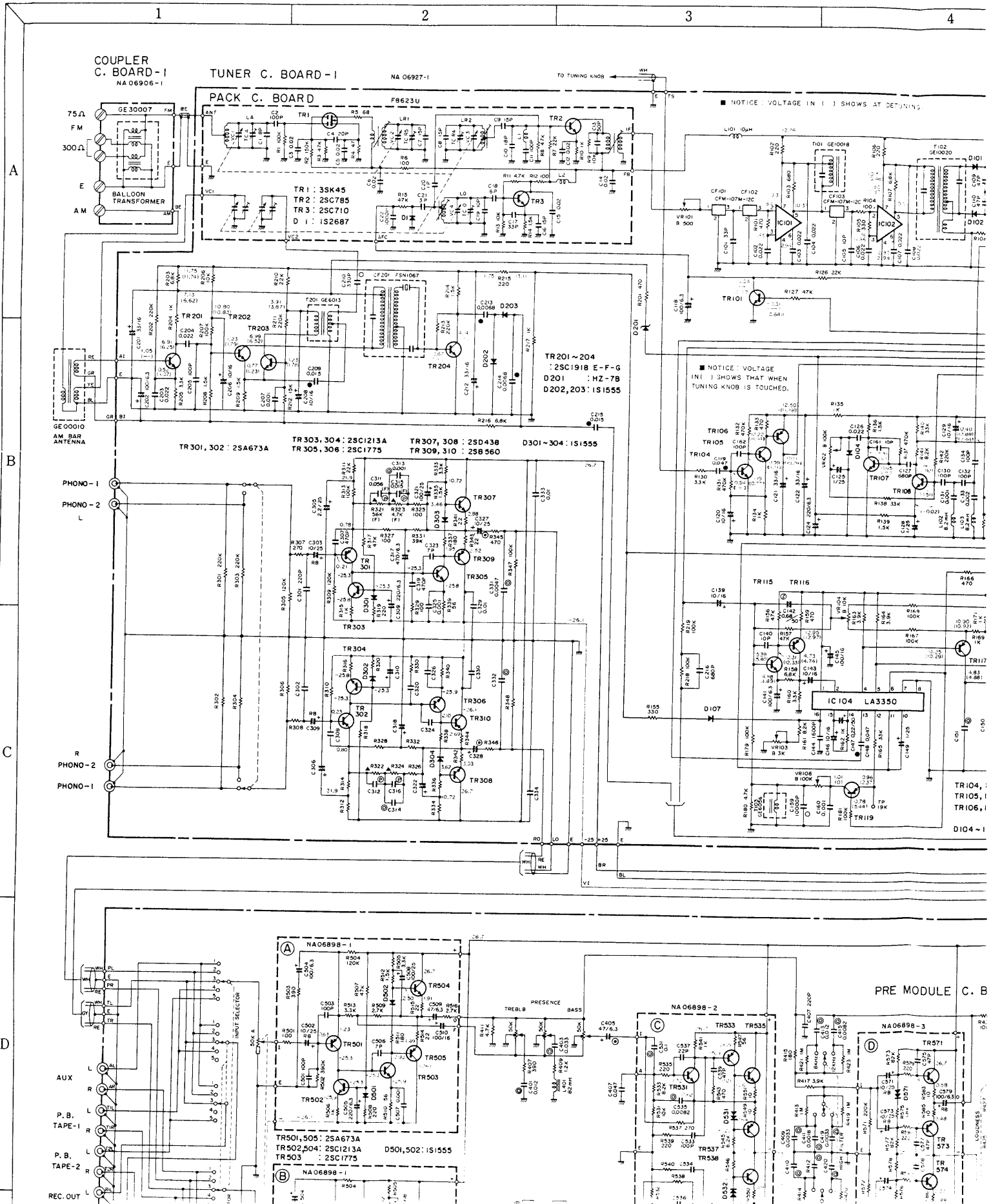

MAIN C.

NOTICE: VOLTAGE IN ( ) SHOWS AT DETUNE.

VOLTAGE  
1. 2.0V (1.2V)  
1. 0.2V (0.2V)  
1. 0.2V (0.2V)  
1. 0.2V (0.2V)  
1. 0.2V (0.2V)

TRI1: 2SC1918 E-F-G  
TRI2,103: 2SK68A  
IC101,102:  $\mu$ PC577H  
IC103: TA7136P  
D101~103: 1S1555

NOTICE: VOLTAGE IN ( ) SHOWS THAT WHEN TUNING KNOB IS TOUCHED.

VOLTAGE  
1. 13.12 (13.6V)  
2. 2.73V (-)  
4. 10.25 (10.25V)  
5. 0.23 (10.28V)  
7. 0.10V  
8. 0.10V

VOLTAGE  
10. 2.13 (2.6V)  
11. 2.13 (2.6V)  
12. 2.13 (2.6V)  
13. 2.13 (2.6V)  
14. 2.13 (2.6V)  
15. 2.13 (2.6V)  
16. 5.56V (-)

TRI4,107 : 2SC1918 B-C  
TRI5,108,110,111,115 : 2SC1918 E-F-G  
TRI6,109,112~114,116~119 : 2SA844  
D104~107 : 1S1555 D108 : HZ-78

TU. C. BOARD-3  
NA 06927-3

TU. C. BOARD-2  
NA 06927-2

POWER SUPPLY C.

PRE MODULE C. BOARD - (A) ~ (E)

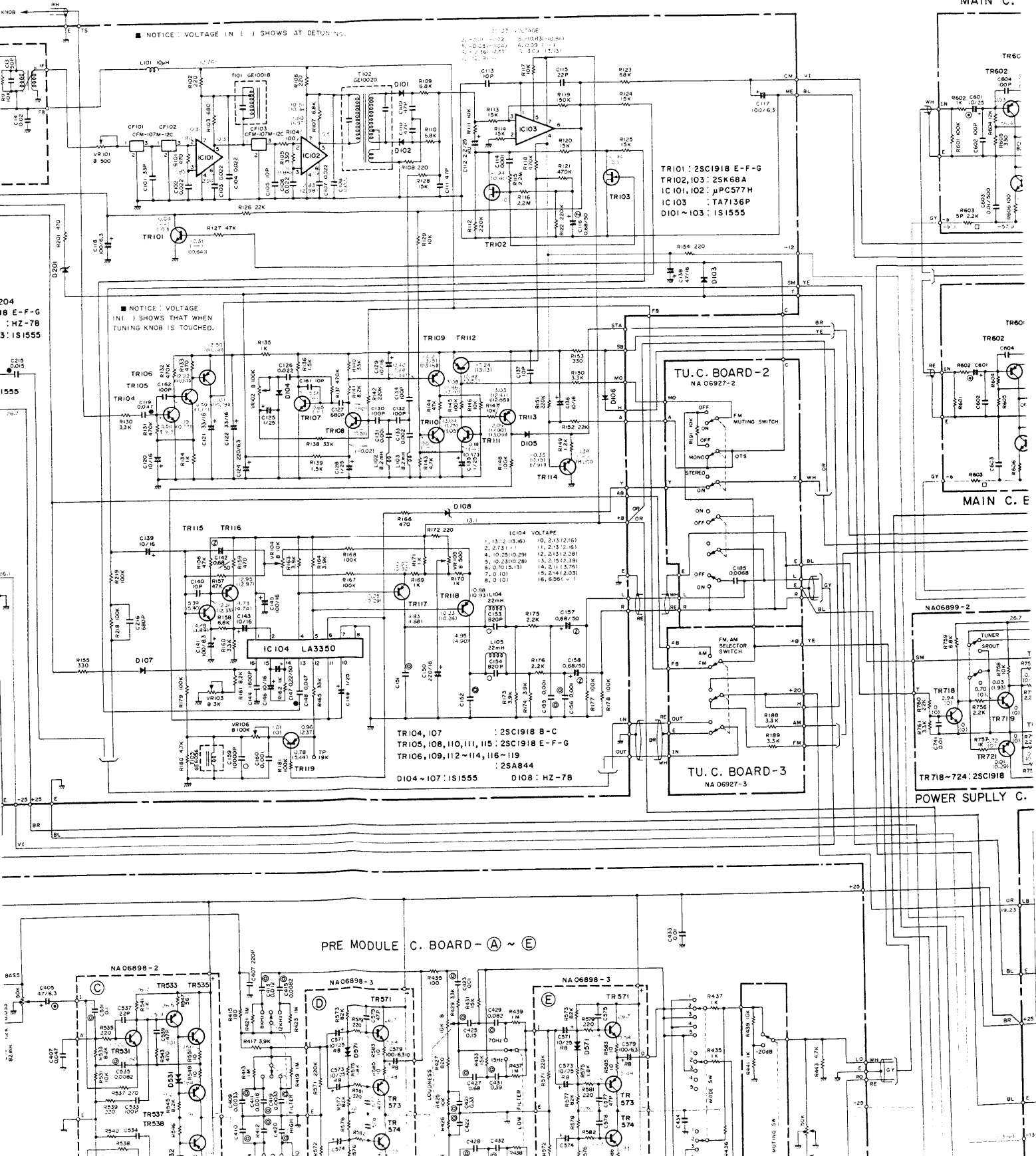

MAIN C. BOARD - R NA 06885

TR601 - 603 : 2SA872  
TR604, 605 : 2SC1918 E-F-G  
TR 606 : 2SC1628

TR607 : 2SA844  
TR608 : 2SC458 B-C  
TR609 : 2SC734 O-Y  
TR610 : 2SA561 O-Y  
TR611 : 2SC1212 B  
TR612 : 2SA743 B  
TR613 : 2SD425  
TR614 : 2SB555

D601,603~607 : IS1555  
D602 : HZ-6C

MAIN C. BOARD - L NA 06885

POWER SUPPLY C. BOARD - 2 NA06899-2

TR717, 718 : 2SC1918  
D701~712 : IS1555

D718,719 : IS1555

TR702 : 2SB544 TR706,709,710 : 2SC1918 TR711 : 2SA844

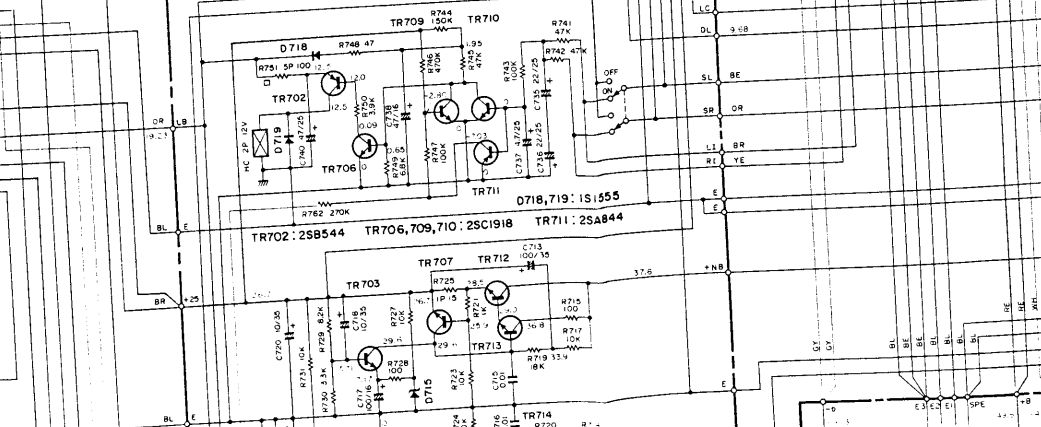
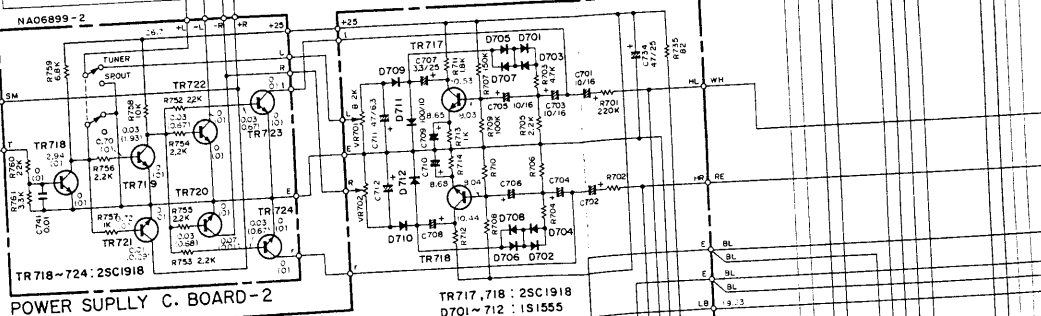
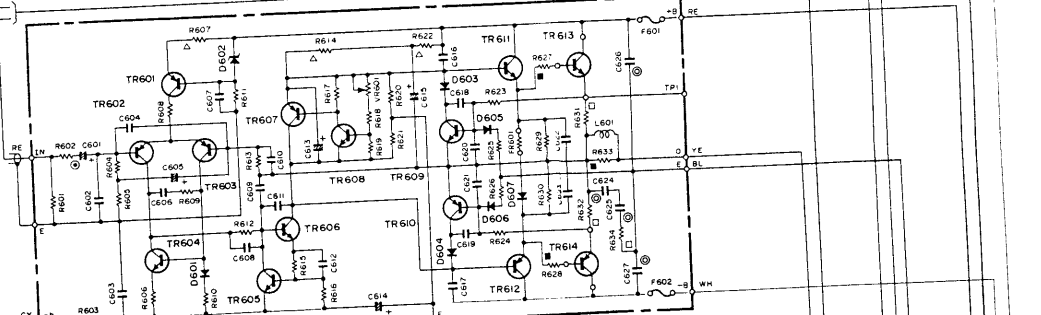
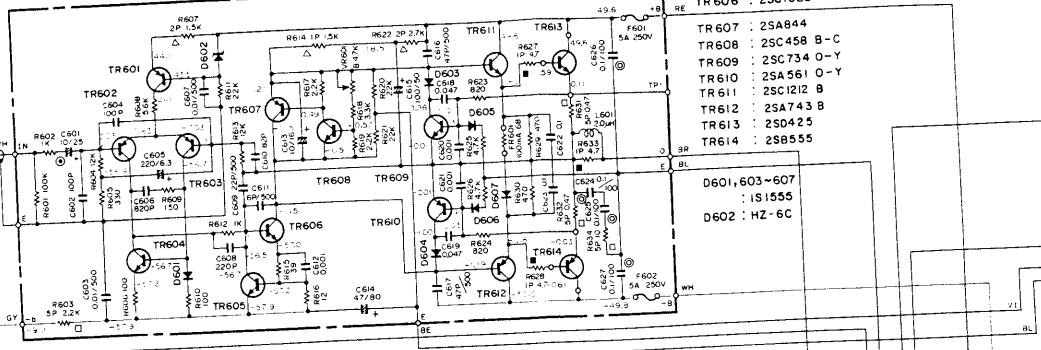
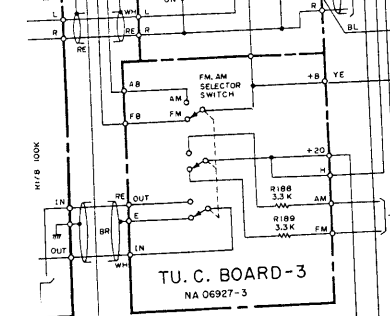
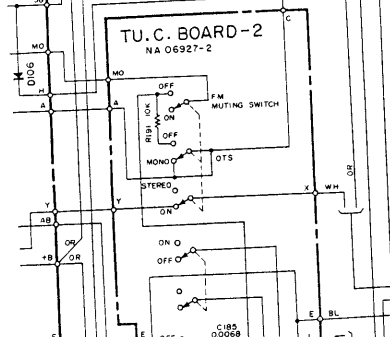
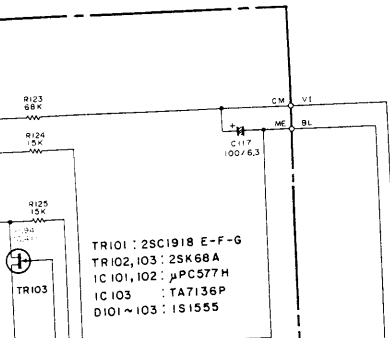

TR601 ~ 603 : 2SA872  
TR604, 605 : 2SC1918 E-F-G  
TR606 : 2SC1628

TR607 : 2SA844  
TR608 : 2SC458 B-C  
TR609 : 2SC734 O-Y  
TR610 : 2SA561 O-Y  
TR611 : 2SC1212 B  
TR612 : 2SA743 B  
TR613 : 2SD425  
TR614 : 2SB555

D601, 603 ~ 607 : IS1555  
D602 : HZ-6C

COUPLER C. BOARD-2  
NA06906-2

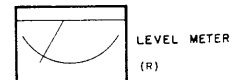
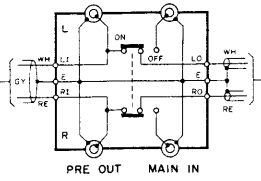

LEVEL METER (R)

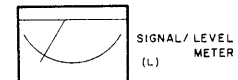

SIGNAL/LEVEL METER (L)

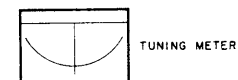

TUNING METER

PRE C. BOARD-5  
NA06896-5

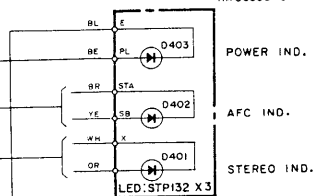

HEAD PHONE C. BOARD-2  
NA06905-2

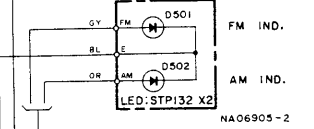

HEAD PHONE C. BOARD-1  
NA06905-1

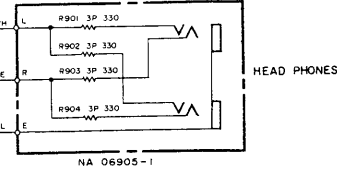

SPEAKER SELECTOR SWITCH

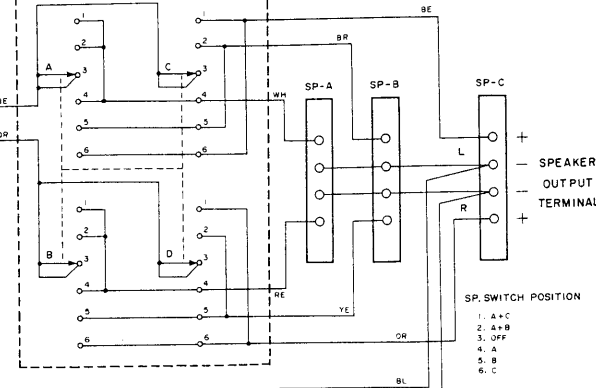

SP. SWITCH POSITION  
1. A+C  
2. A+B  
3. OFF  
4. A  
5. B  
6. C

POWER VOLTAGE

D201 : HZ-7B  
D202, 203 : IS1555

B  
C  
D  
E

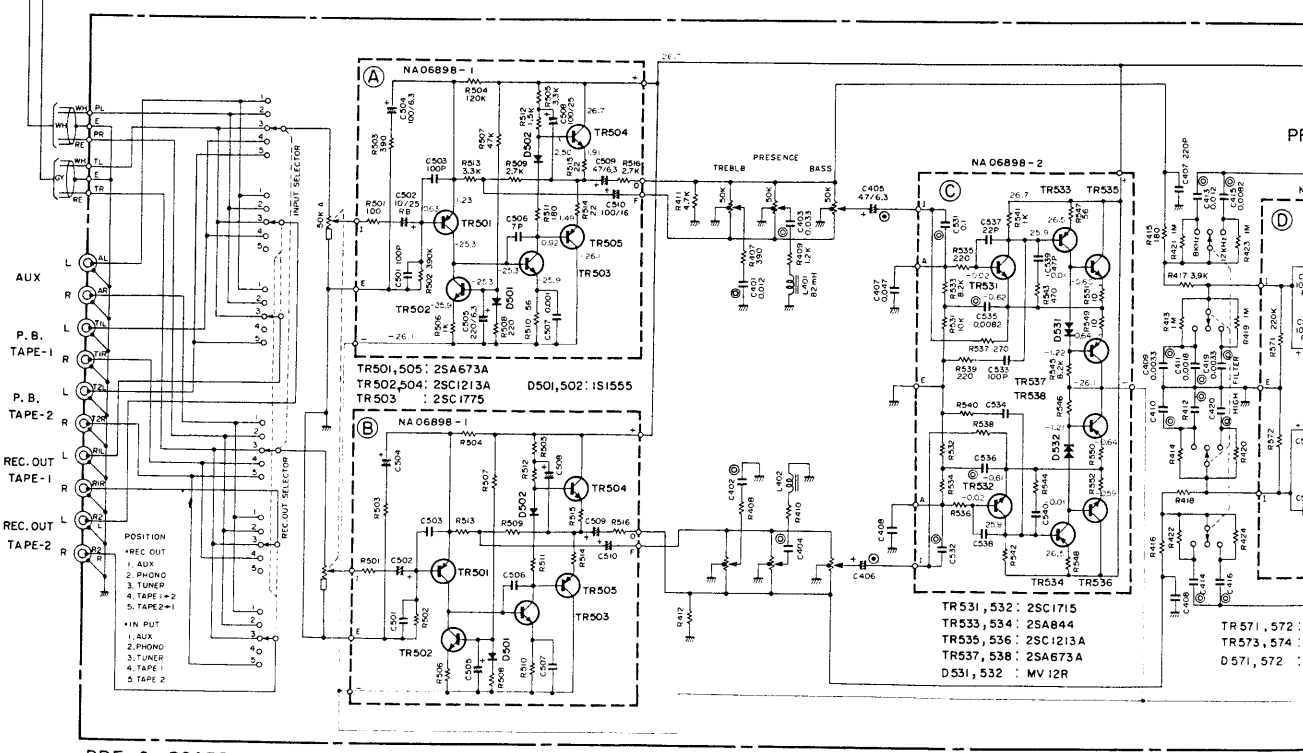
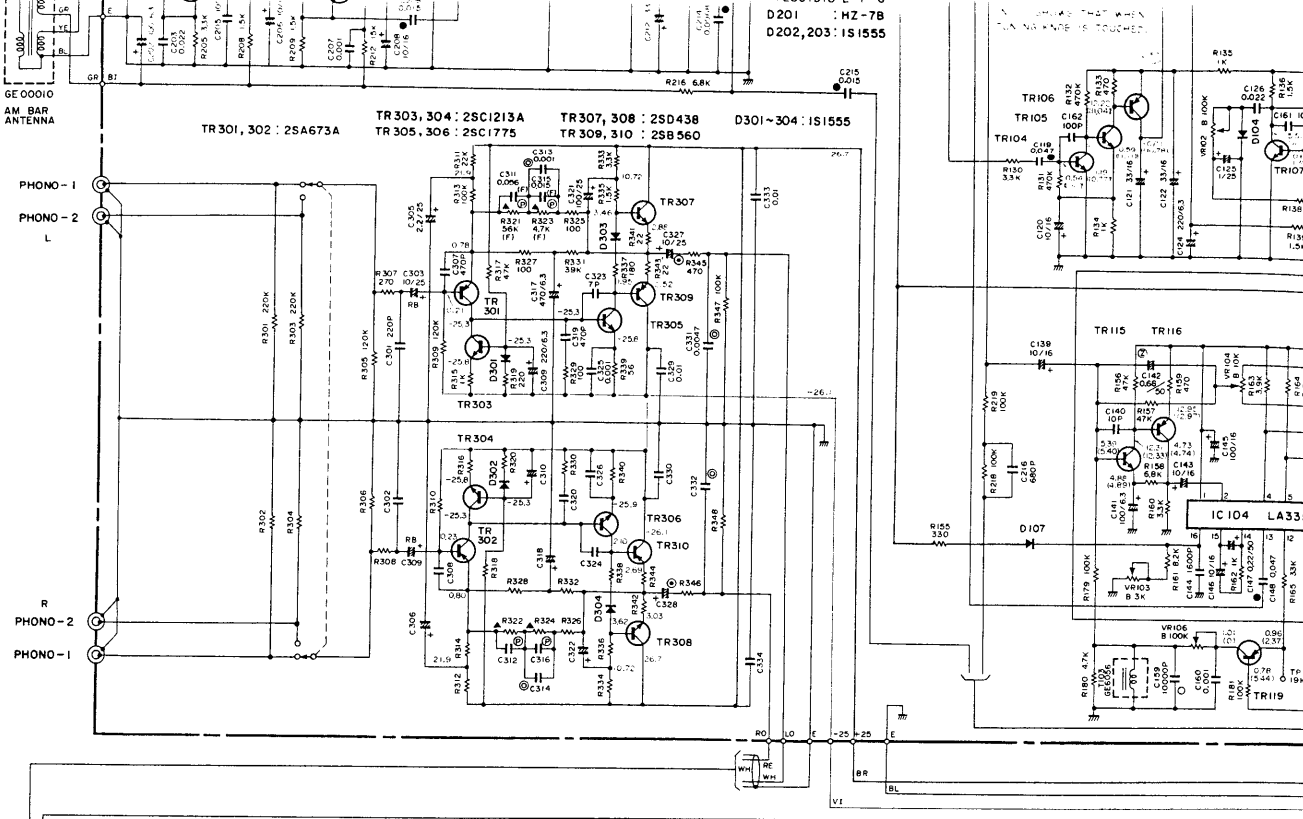

PRE C. BOARD-1

NA 06897 - 1

- RESISTORS**
- : FUSE RESISTOR
  - ▲ : METALIZED FILM RESISTOR
  - △ : METALIZED OXIDATION RESISTOR
  - : FIRE PROOF RESISTOR
  - : CEMENT MOLDED RESISTOR
  - NO MARK : CARBON RESISTOR
  - ⊠ : METAL FILM RESISTOR
- CAPACITORS**
- ⊕ : UPF CAPACITOR
  - ⊖ : SBL CAPACITOR
  - ⊙ : MYLAR CAPACITOR
  - : POLYSTYRENE CAPACITOR
  - NO MARK : CERAMIC CAPACITOR
  - ⊗ : Z CAPACITOR
  - ⊚ : MS CAPACITOR
  - ⊙ : TANTALUM CAPACITOR
  - RB : RB CAPACITOR
  - NO MARK : ELECTROLYTIC CAPACITOR



TR204 : 2SC1918 E-F-G  
 D201 : HZ-7B  
 D202,203 : 1S1555

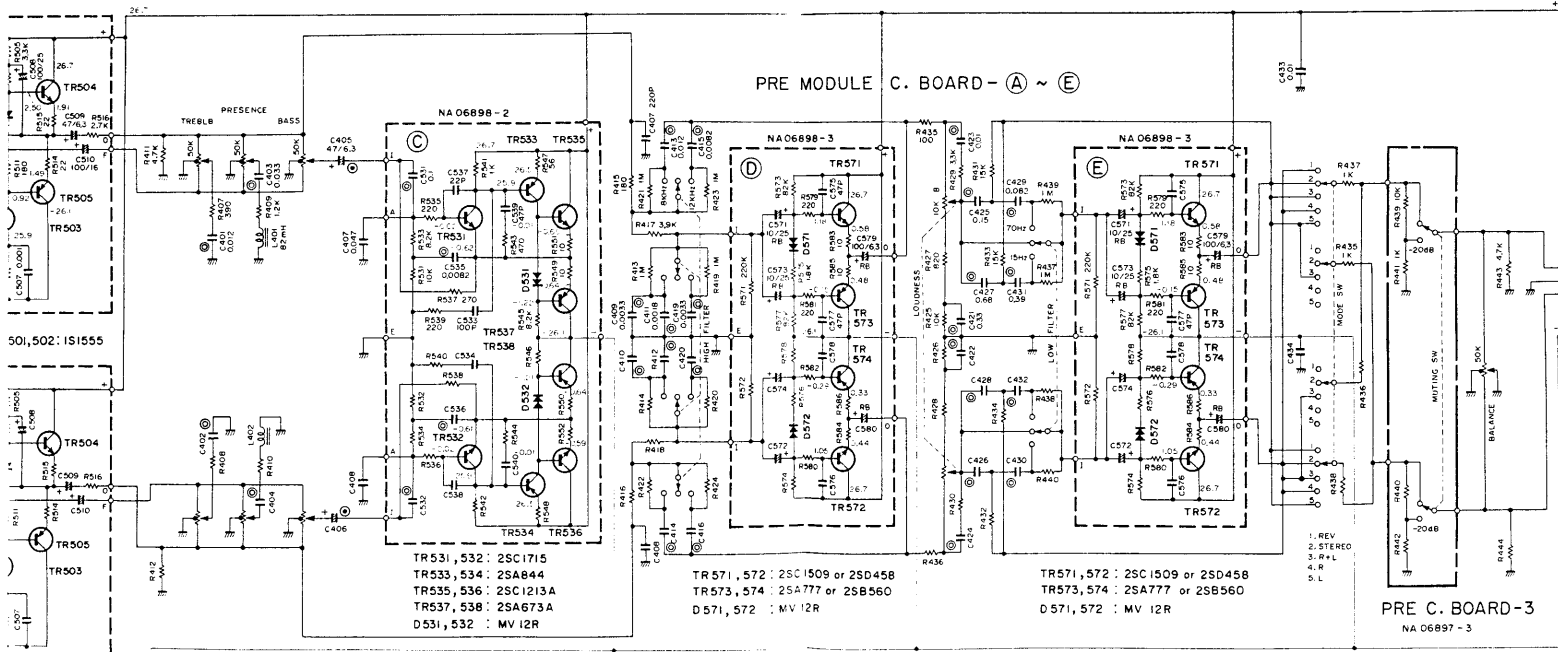
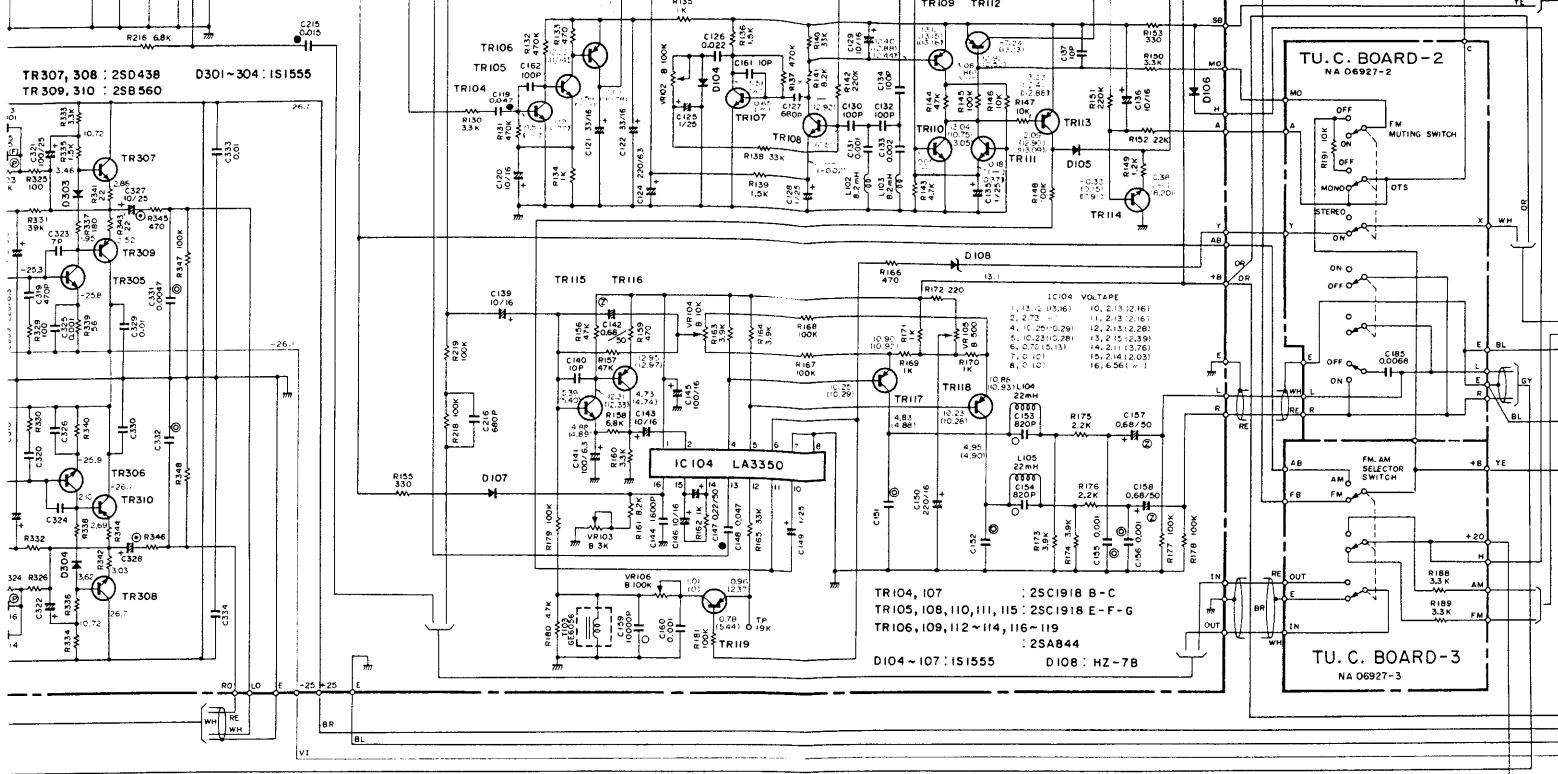

— FILM RESISTOR  
 ▭ MOLDED RESISTOR  
 ▭ ON RESISTOR

**CAPACITORS**

⊕ : UPF CAPACITOR  
 ⊙ : SBL CAPACITOR  
 ⊗ : MYLAR CAPACITOR  
 ○ : POLYSTYRENE CAPACITOR  
 NO MARK : CERAMIC CAPACITOR

⊕ : Z CAPACITOR  
 ⊙ : MS CAPACITOR  
 ⊗ : TANTALUM CAPACITOR  
 ○ : RB CAPACITOR  
 NO MARK : ELECTROLYTIC CAPACITOR

**WIRE COLOR ABBREVIATIONS**

BL : BLACK      YE : YELLOW      GY : GRAY  
 BR : BROWN    GR : GREEN       WH : WHITE  
 RE : RED       BE : BLUE       GG : LIGHT GREEN  
 OR : ORANGE   VI : VIOLET      SB : LIGHT BLUE  
 PK : PINK

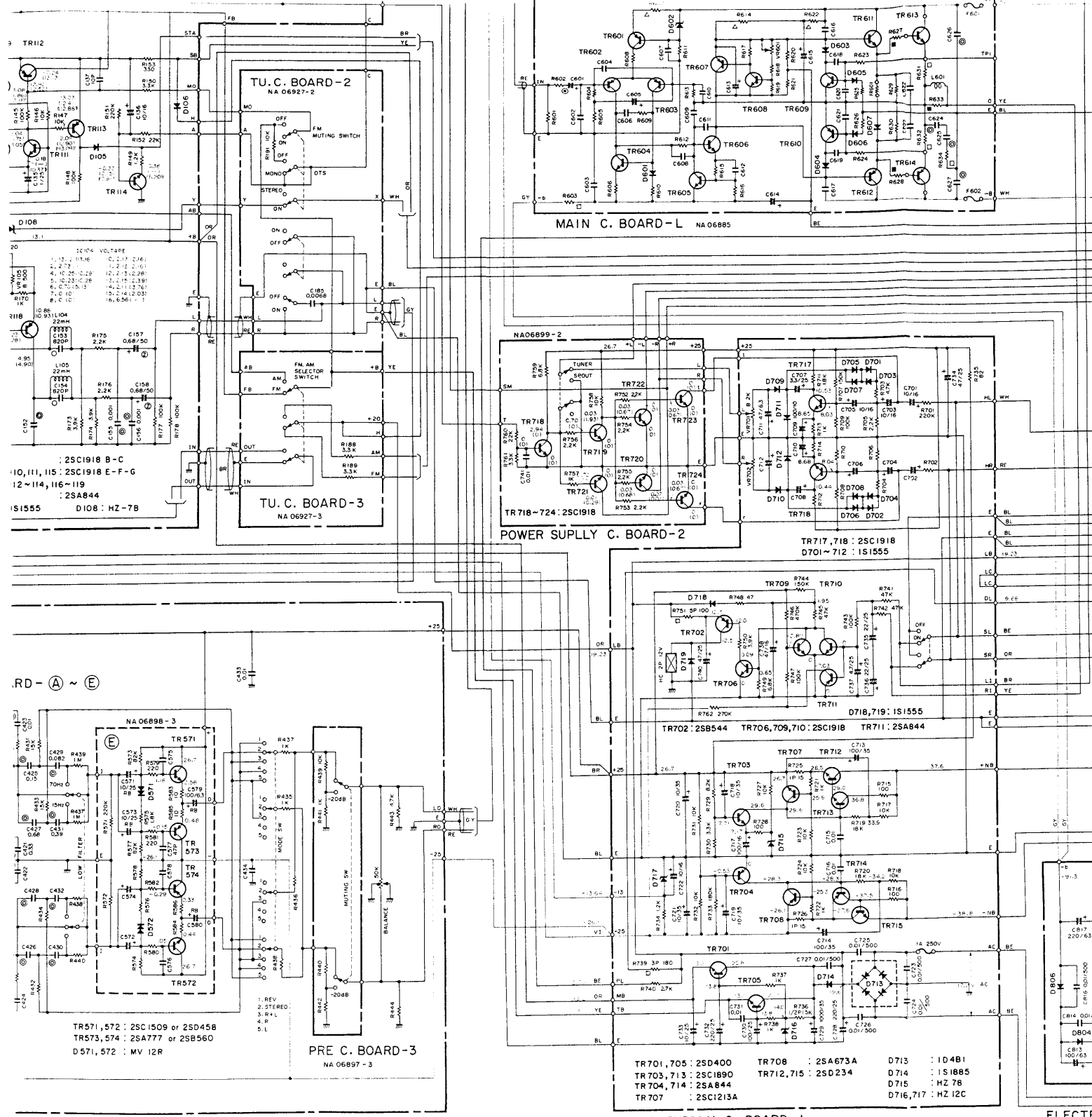

- R ABBREVIATIONS**
- YELLOW GY : GRAY
  - GREEN WH : WHITE
  - BLUE GG : LIGHT GREEN
  - VIOLET SB : LIGHT BLUE
  - PK : PINK

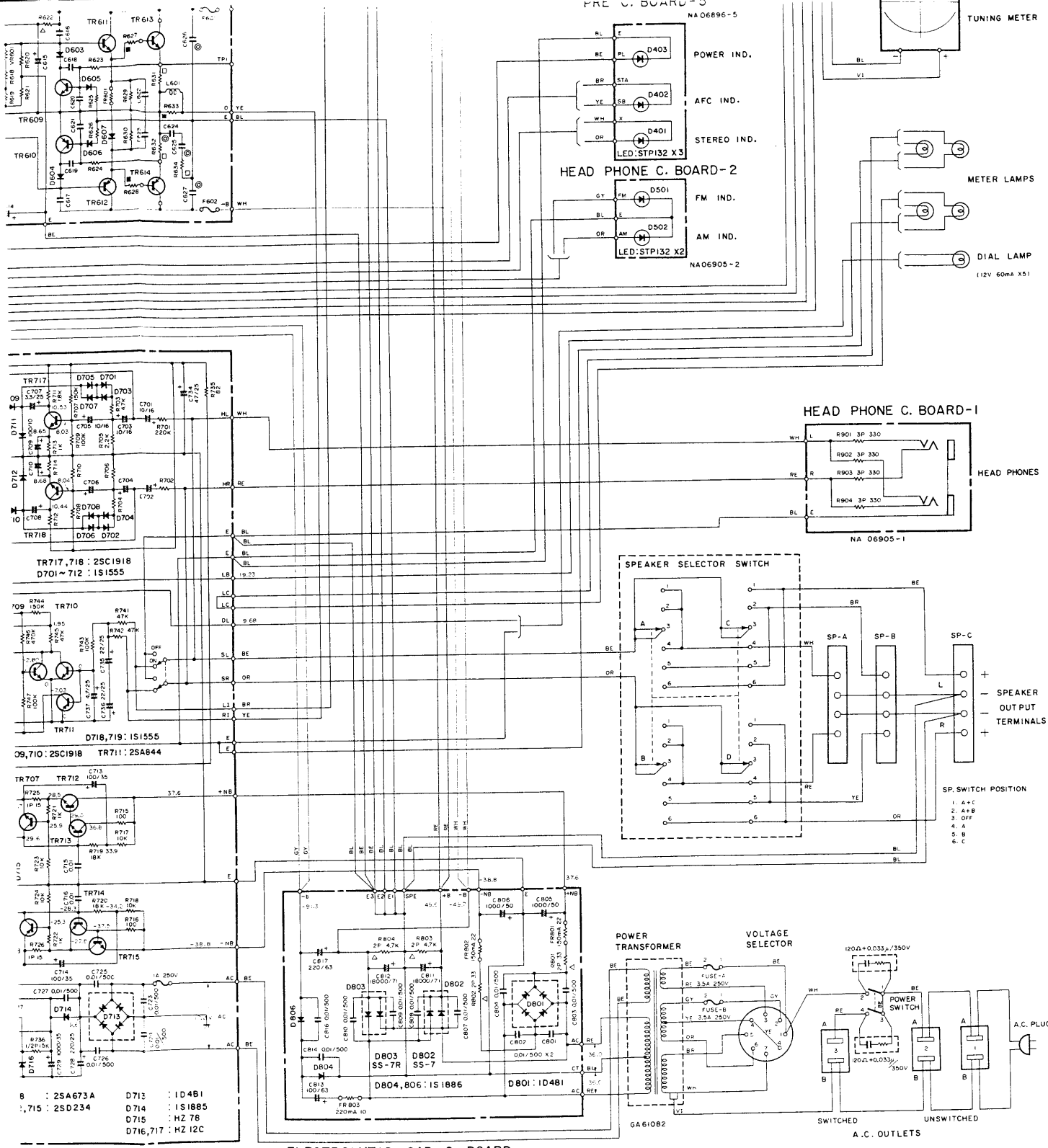

)-1 NA 06899-1

ELECTROLYTIC CAP. C. BOARD NA 06904

For Service Manuals  
**MAURITRON SERVICES**  
 8 Cherry Tree Road, Chinnor  
 Oxfordshire, OX9 4QY.  
 Tel (01844) 351694  
 Fax (01844) 352554  
 email:- sales@mauritron.co.uk

# WIRING

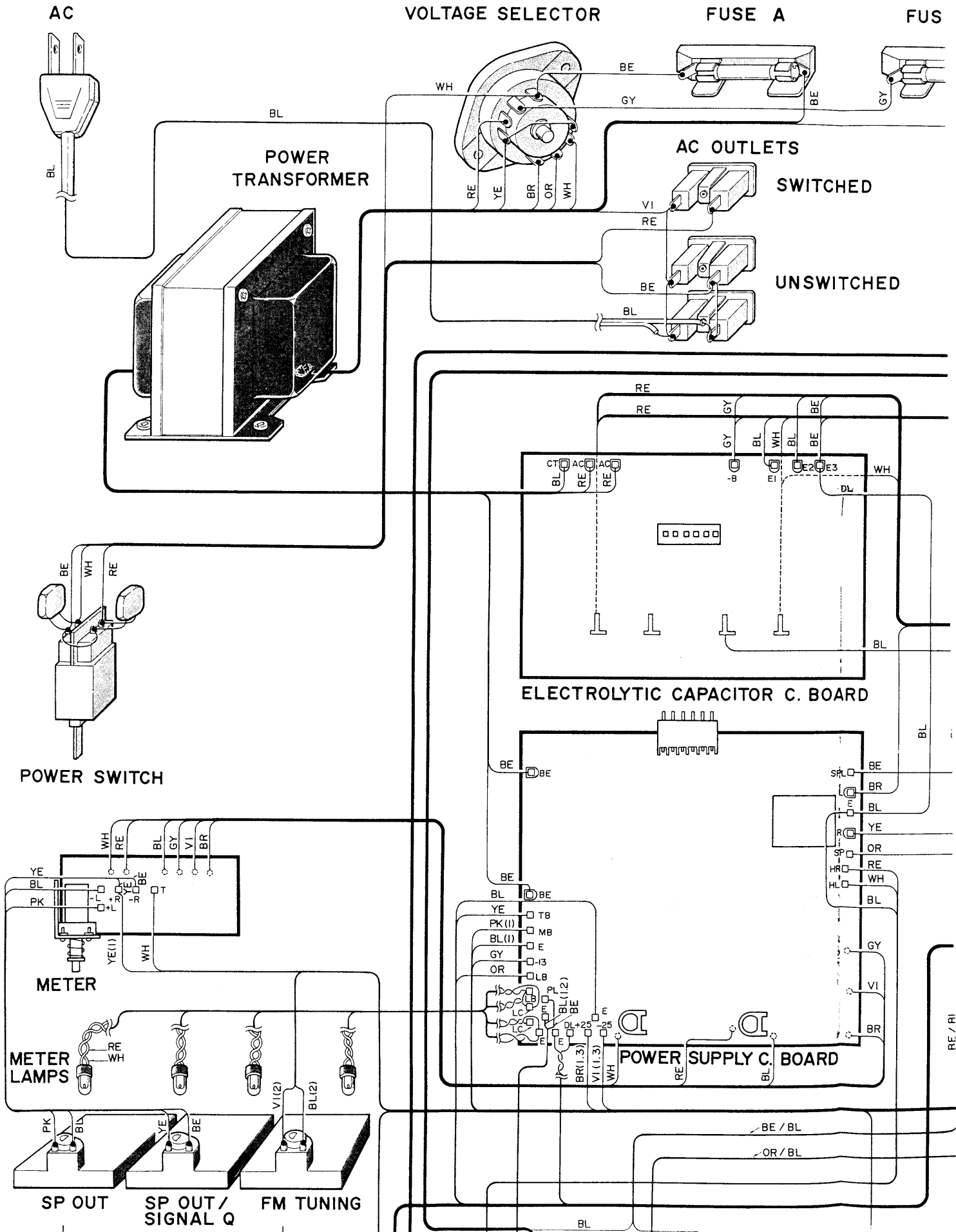

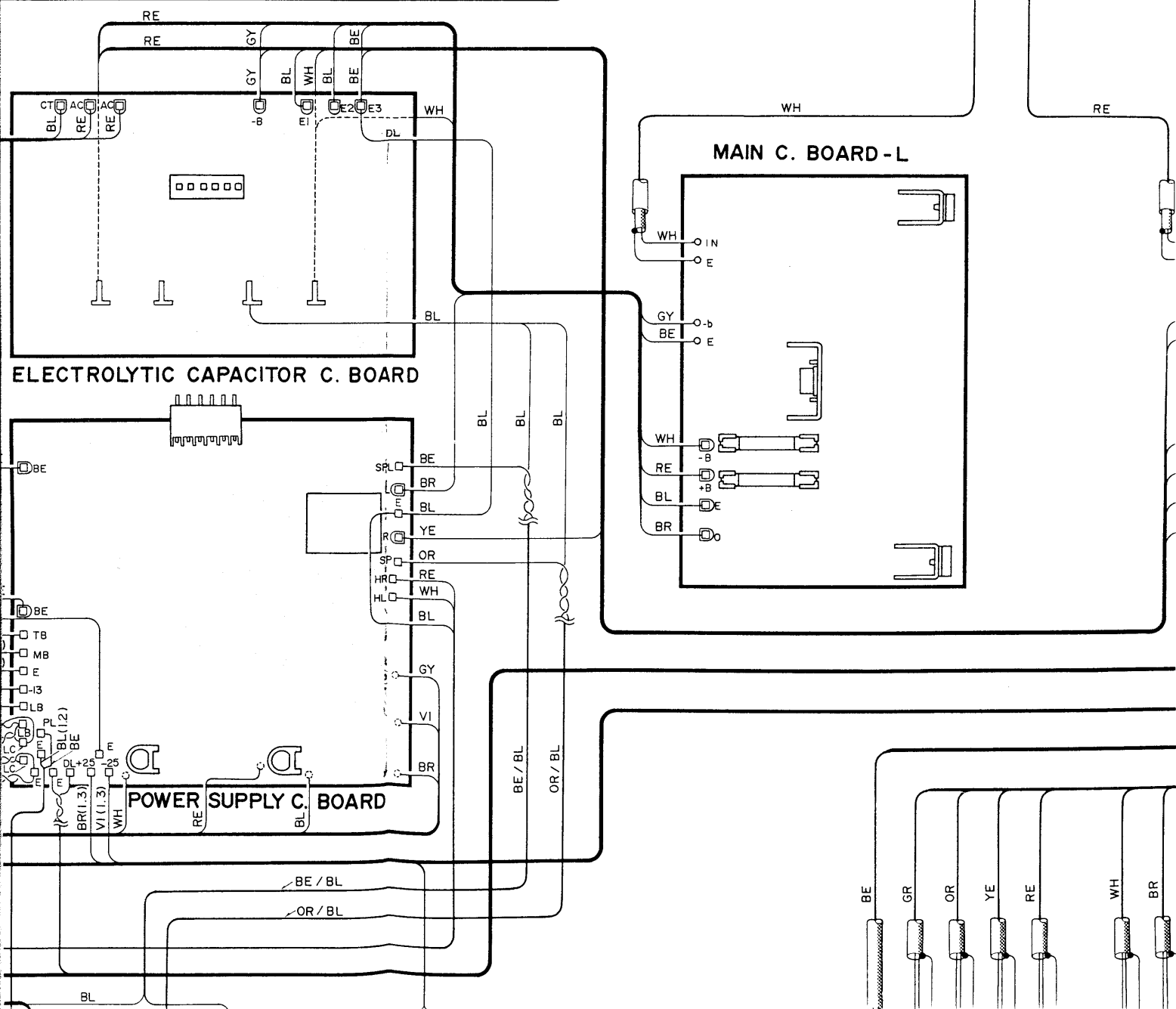
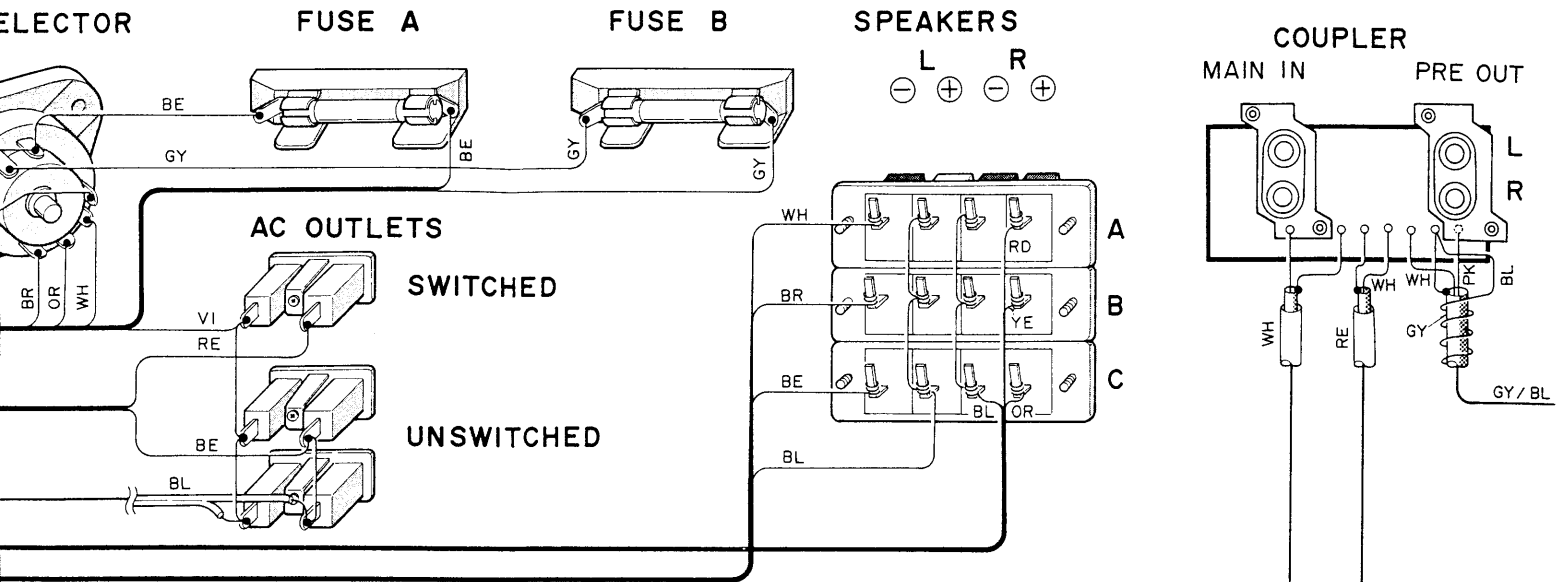

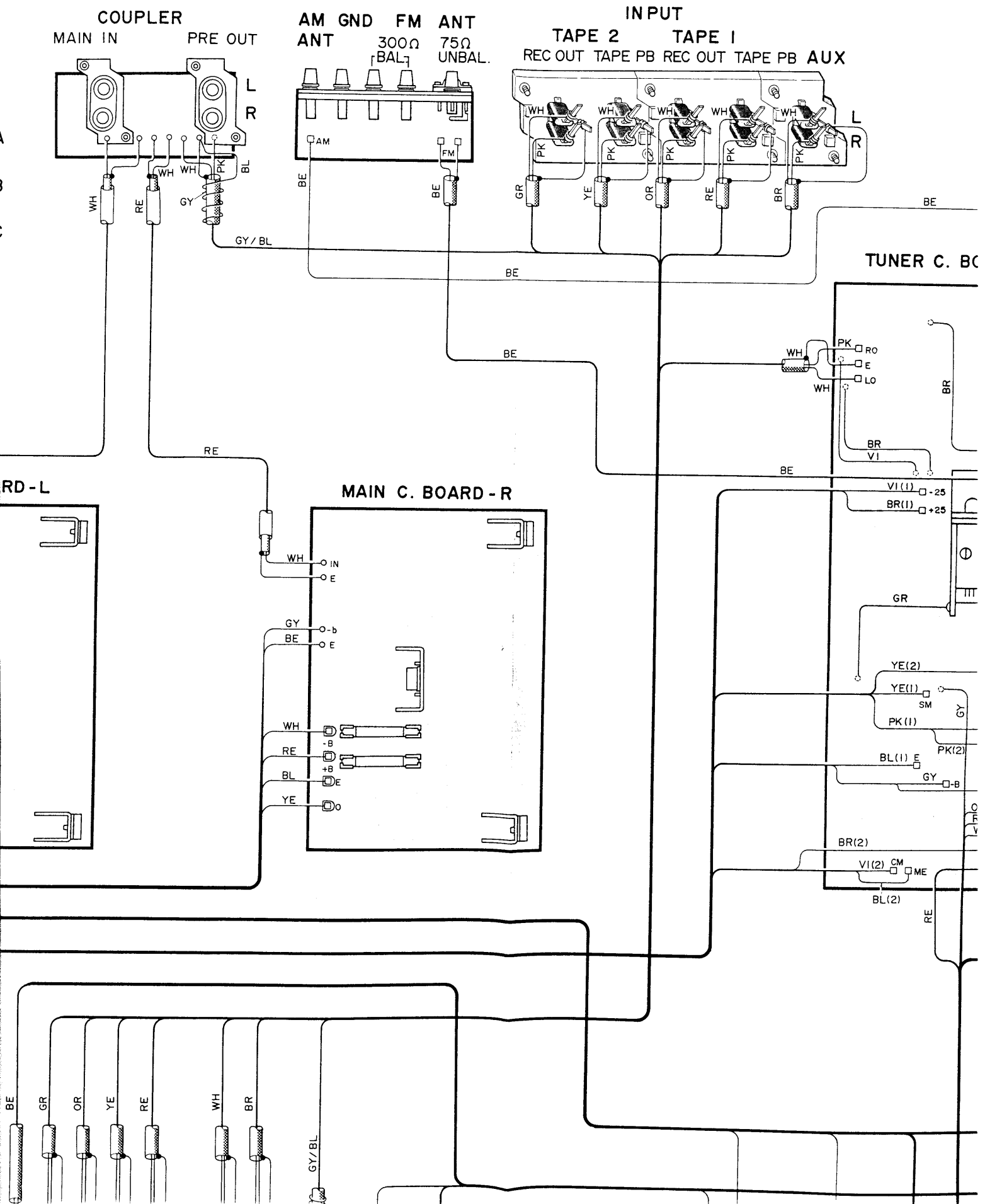

INPUT  
TAPE 2 TAPE 1  
C OUT TAPE PB REC OUT TAPE PB AUX

BAR ANTENNA

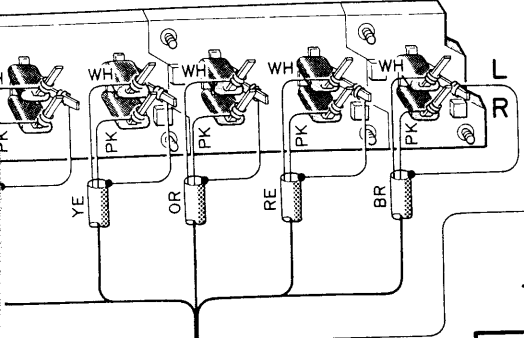
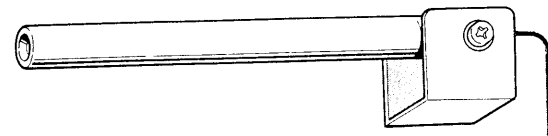

TUNER C. BOARD

INPUT  
PHONO2 PHONO1

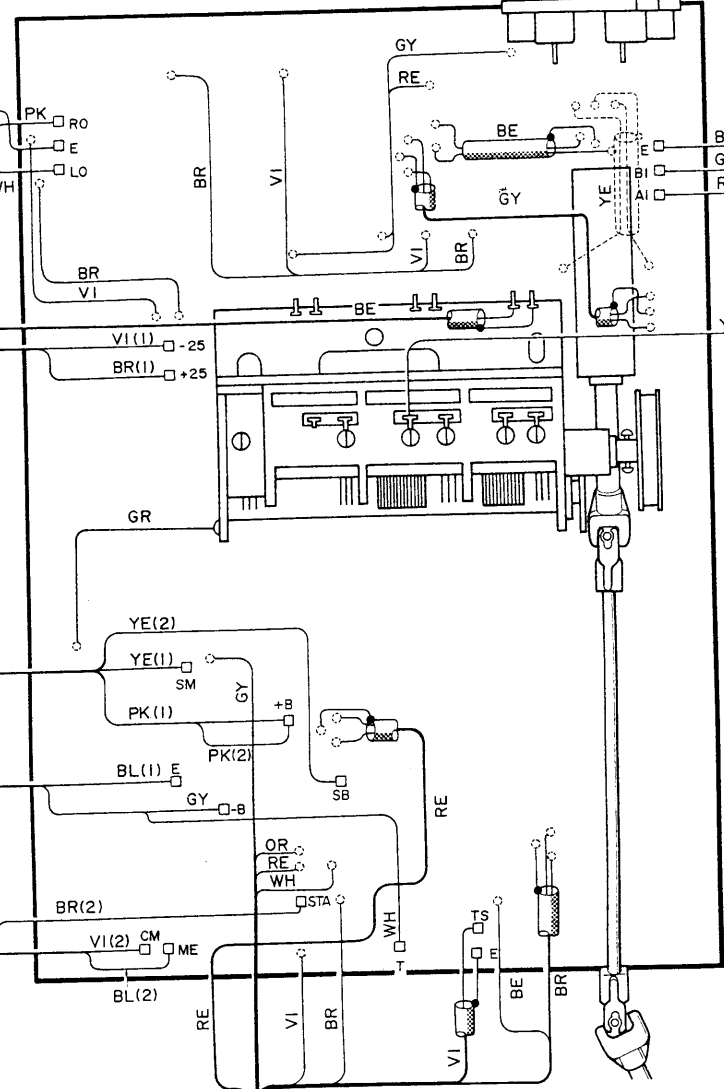

PHONO SELECTOR

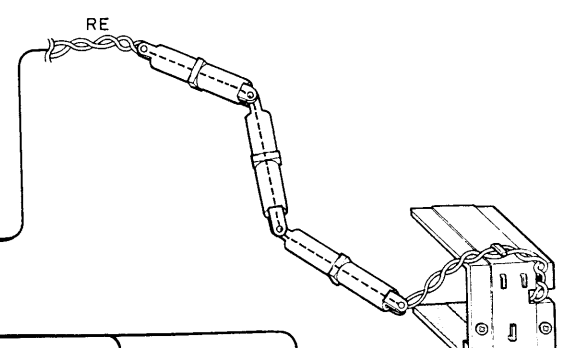

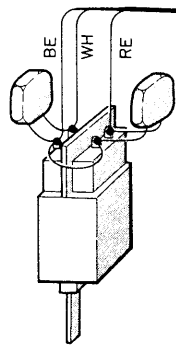

POWER SWITCH

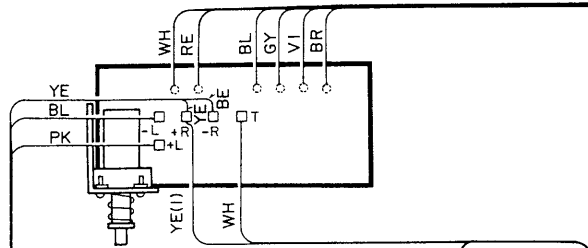

METER

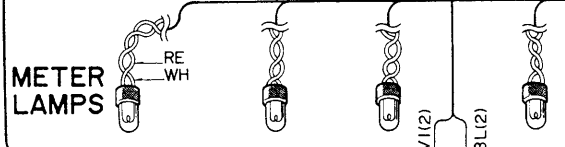

METER LAMPS

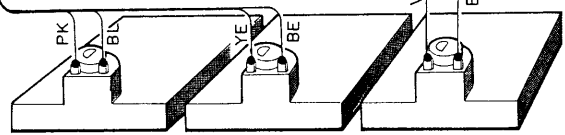

METERS

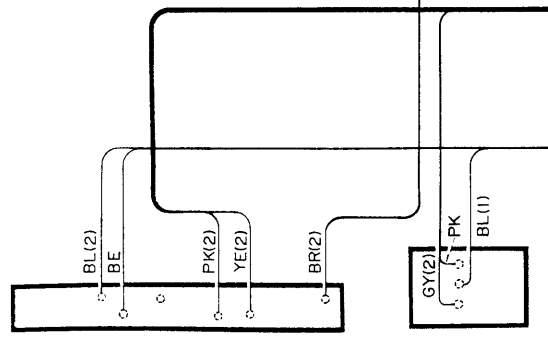

INDICATORS

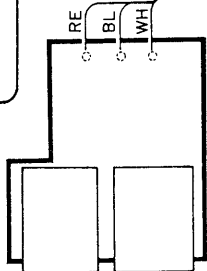

PHONES

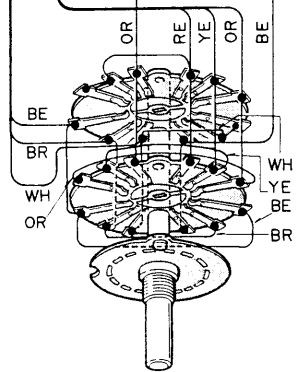

SPEAKERS

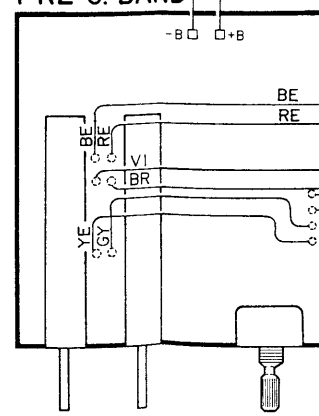

LOW HIGH FILTER FILTER BASS

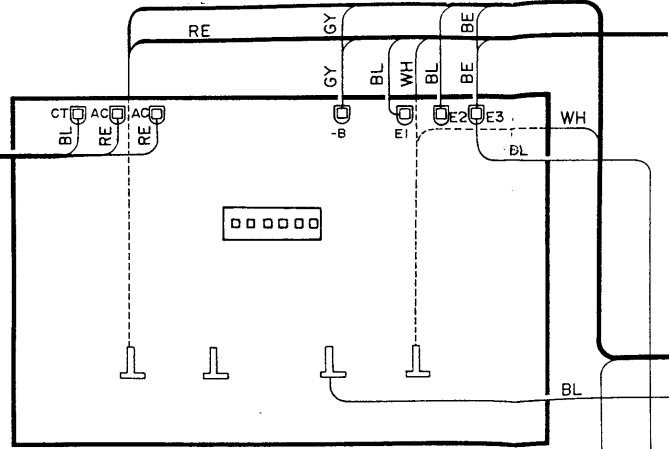

ELECTROLYTIC CAPACITOR C. BOARD

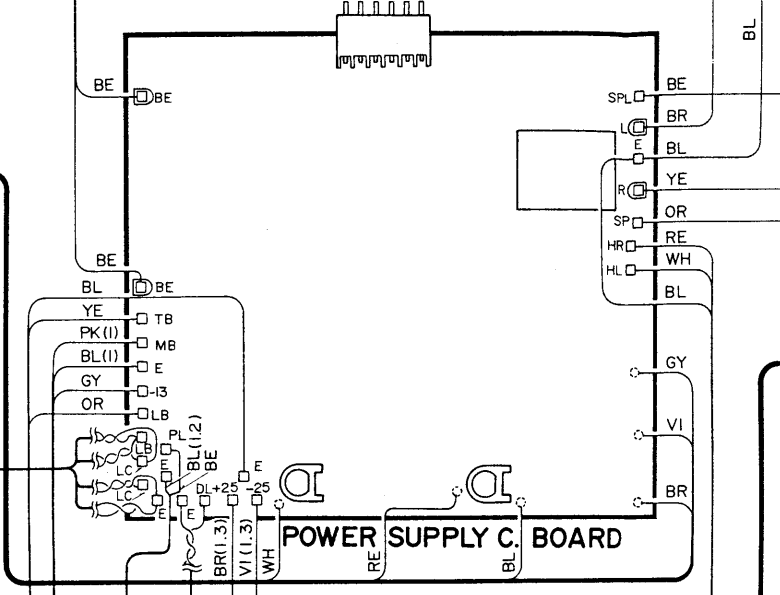

POWER SUPPLY C. BOARD



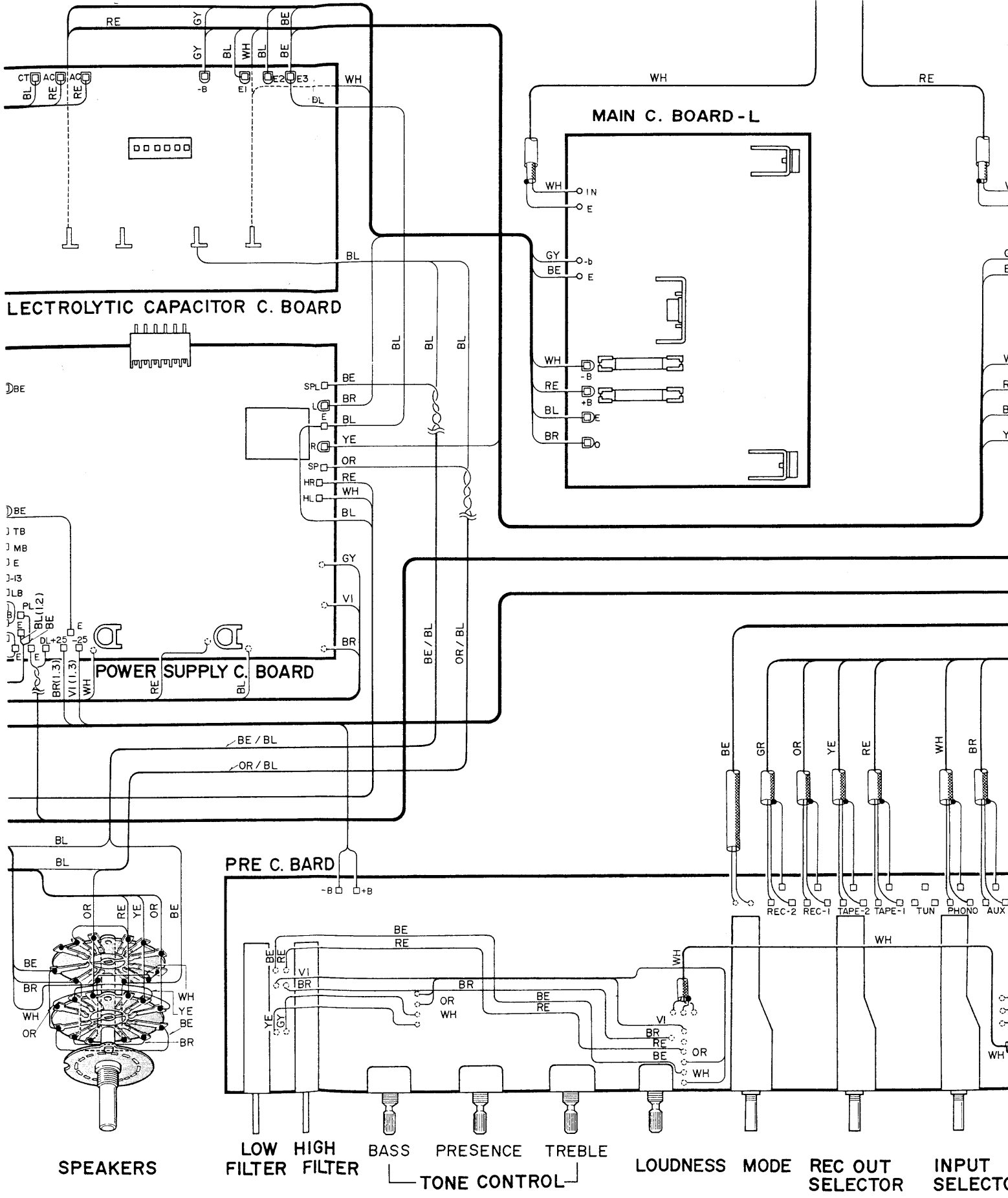

**ELECTROLYTIC CAPACITOR C. BOARD**

**MAIN C. BOARD - L**

**POWER SUPPLY C. BOARD**

**PRE C. BOARD**

**SPEAKERS**

**LOW HIGH FILTER FILTER** **BASS PRESENCE TREBLE** **TONE CONTROL**

**LOUDNESS MODE REC OUT SELECTOR INPUT SELECTOR**

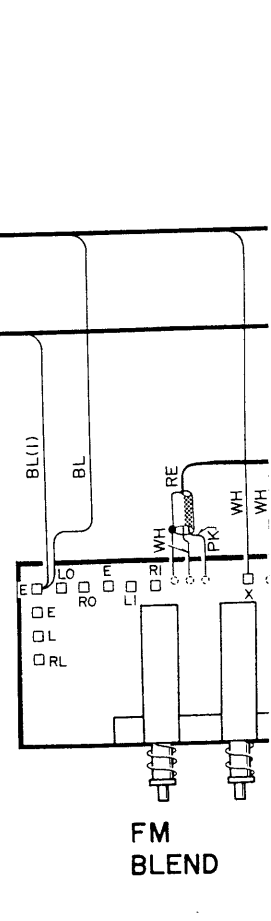
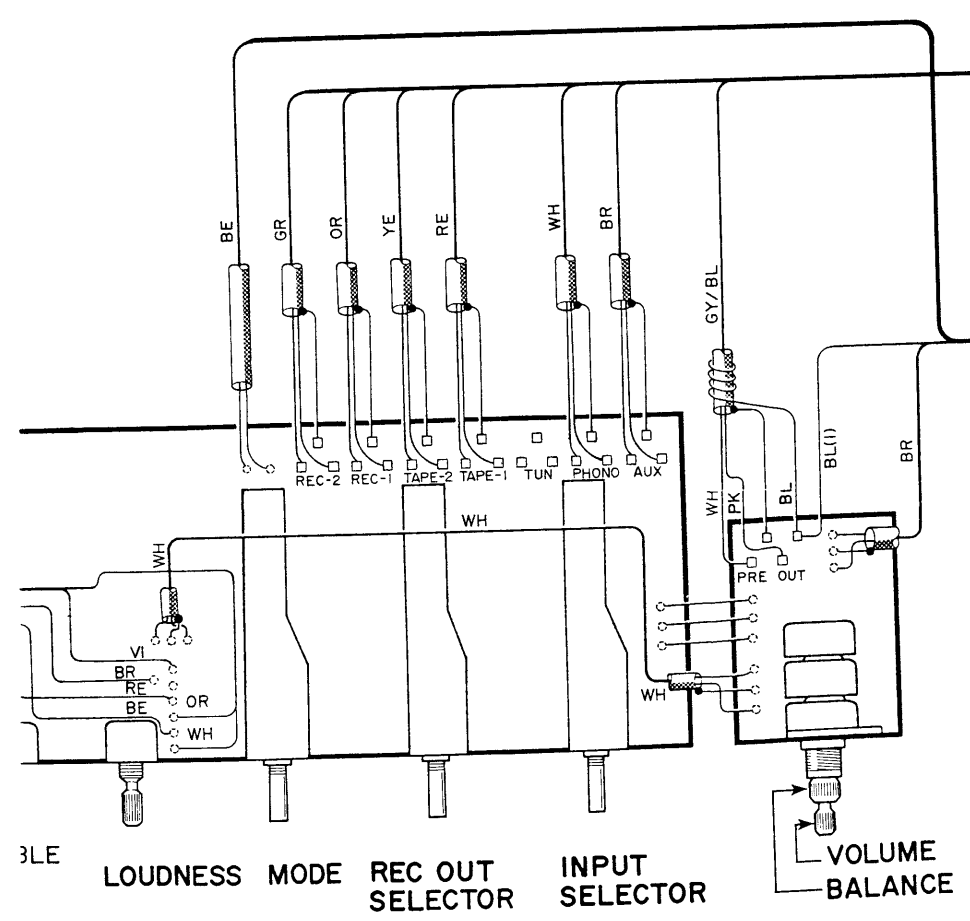
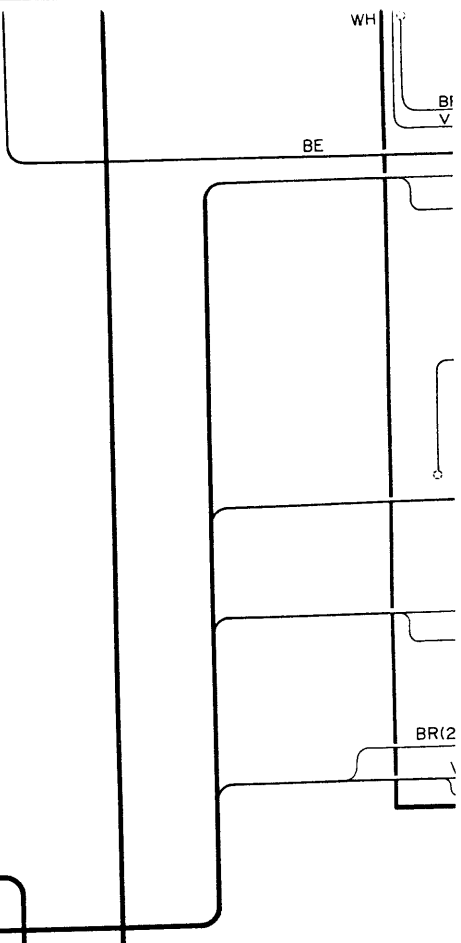
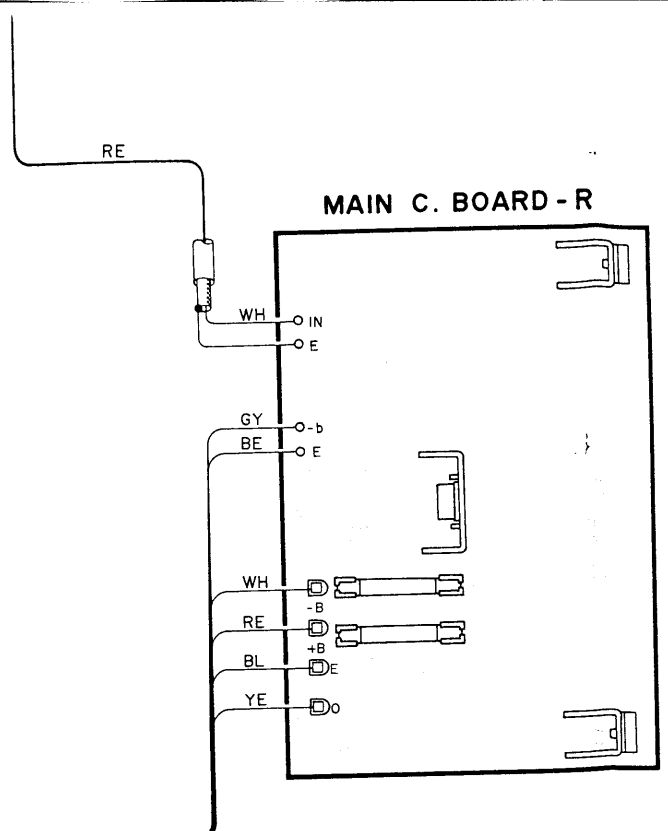
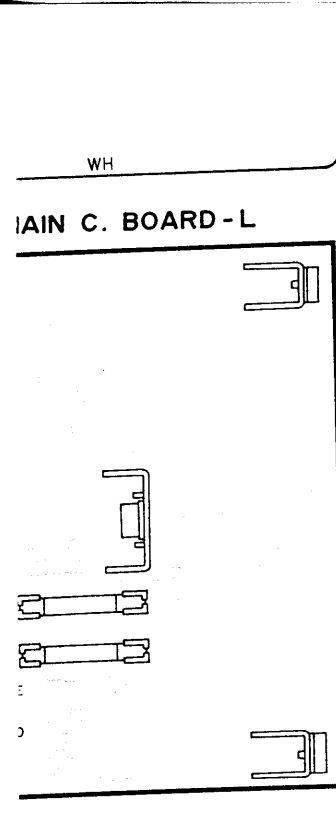

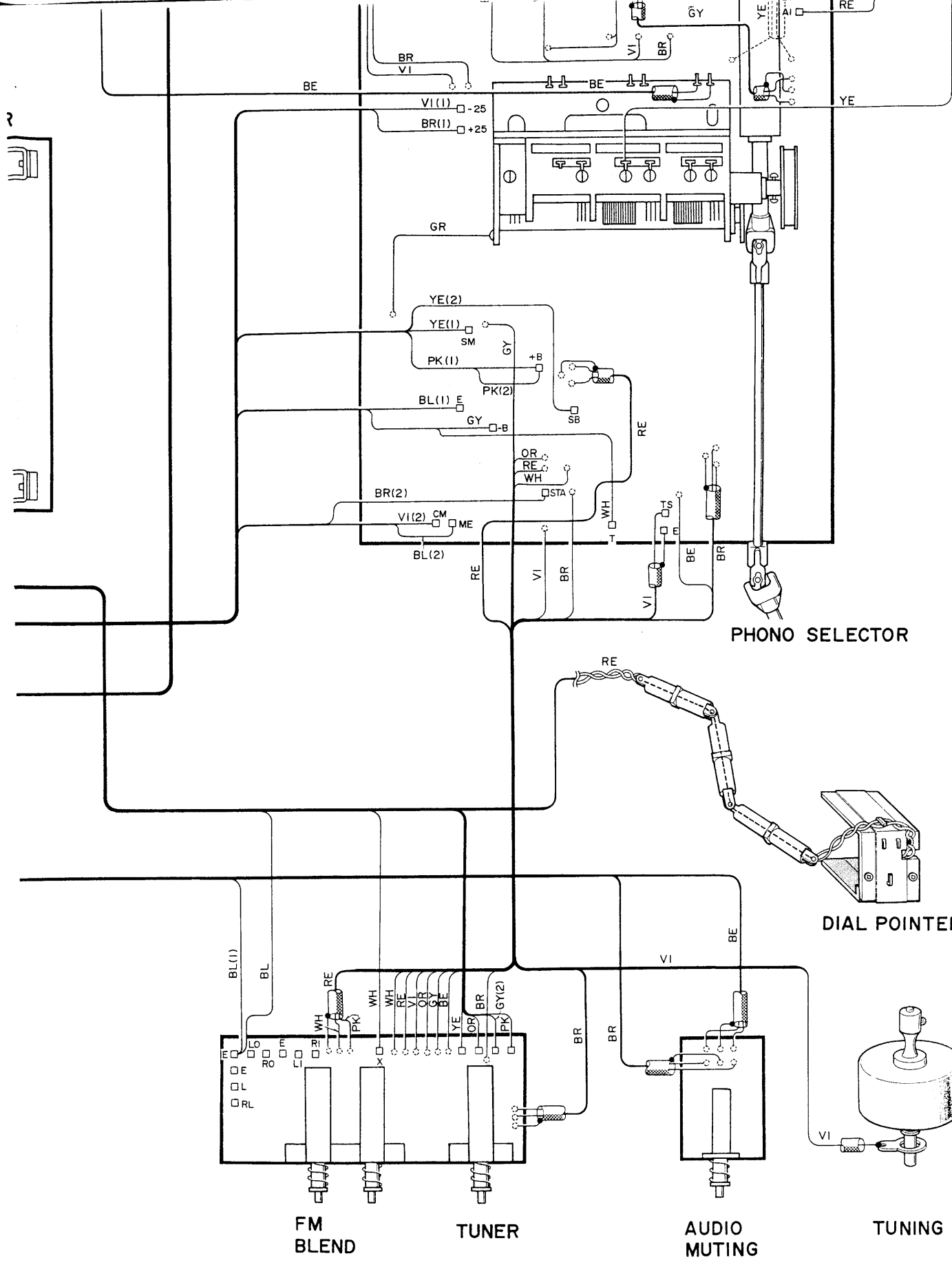

For Service Manuals  
**MAURITRON SERVICES**  
 8 Cherry Tree Road, Chinnor  
 Oxfordshire, OX9 4QY.  
 Tel (01844) 351694  
 Fax (01844) 352554  
 email:- sales@mauritron.co.uk

# PARTS LIST

## CR-1020

FM/AM STEREO RECEIVER

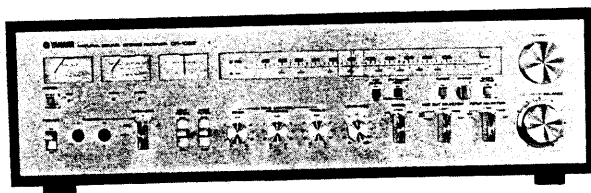

SINCE 1887



# YAMAHA

NIPPON GAKKI CO., LTD. HAMAMATSU, JAPAN

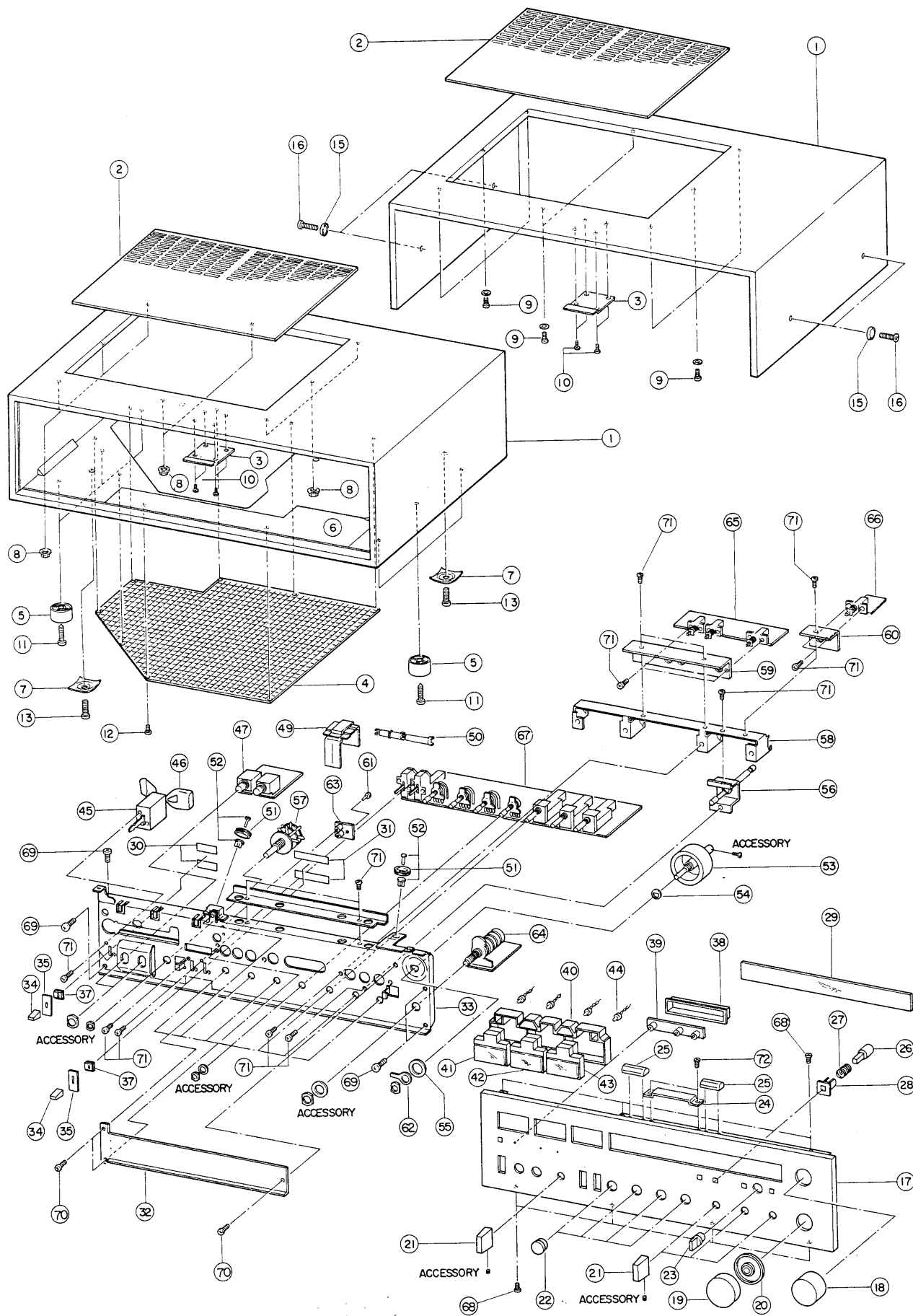

Ref. No.	Part No.	Description	Remarks	Common Models
1	3 2 0 0 1 5 5 0 6 1 5 1 1 0	Cabinet	外装組み上り	R,U,C,A
	3 2 0 0 1 5 5 0 6 1 5 2 1 0	-do.-	//	E,B
2	3 2 0 0 0 0 A A 0 8 5 3 1 0	Radiator Grille	放熱グリル	R,U,C,A
	3 2 0 0 0 0 C B 0 7 9 4 0 0	-do.-	//	E,B
3	3 2 0 0 0 0 A A 0 8 5 3 2 0	Metal, Warp Prevention	反り止め金具	R,U,C,A
	3 2 0 0 0 0 A A 0 8 5 3 0 0	-do.-	//	E,B
4	3 2 0 0 0 0 A A 0 8 5 3 3 0	Punching Metal	パンチングメタル	R,U,C,A
5	4 2 0 0 0 0 C B 0 7 9 4 9 0	Leg	脚	CR-2020, 620,820
6	4 2 0 0 0 0 C A 0 6 5 6 8 0	Shield Paper	バリヤ紙	R,U,C,A
7	3 2 0 0 0 0 A A 0 7 4 6 3 0	Amp. Setting Washer	アンプ取付ワッシャー	R,U,C,A
8	4 2 0 0 0 0 E V 9 0 0 0 3 0	Hexagonal Nut With Washer M3 ZMC2-Y	座付ナット	R,U,C,A
9	4 2 0 0 0 0 E i 0 3 0 1 0 0	Binding Tapping Screw 3×10 ZMC2-Y	バインド タッピングネジ	E,B
10	4 2 0 0 0 0 E Q 7 3 1 1 0 0	Wooden Screw 3.1×10 ZMC2-Y	鉄丸木ネジ	R,U,C,A
11	4 2 0 0 0 0 E Q 7 4 1 2 0 0	-do.- 4.1×20 ZMC2-Y	//	R,U,C,A
12	4 2 0 0 0 0 E Z 0 3 1 1 0 0	Wooden Cums Screw 3.1×10 ZMC2-Y	鉄丸座付木ネジ	R,U,C,A
13	4 2 0 0 0 0 E A 0 5 0 2 5 0	Pan Head Screw 5×25 ZMC2-Y	ナベ小ネジ	R,U,C,A
14	4 2 0 0 0 0 E J 0 4 0 1 4 0	Pan Head Tapping Screw 4×14 ZMC2-Y	ナベタッピングネジ	E,B
15	3 2 0 0 0 0 C B 0 7 9 5 2 0	Hole Cap	ホールキャップ	E,B
16	4 2 0 0 0 0 E D 4 5 0 1 4 0	Binding Head Screw 5×14 FCM3-BI	バインド小ネジ	E,B
17	3 2 0 0 0 0 B A 0 6 9 7 5 0	Panel	パネル	R,A,E,B
	3 2 0 0 0 0 B A 0 6 9 7 4 0	-do.-	//	U,C
18	3 2 0 0 0 0 B A 0 6 9 6 8 0	Knob, Tuning	Tuツマミ	CR-2020
19	3 2 0 0 0 0 B A 0 6 9 6 9 0	-do.-, Volume Control	Volツマミ	-do.-
20	3 2 0 0 0 0 B A 0 6 9 7 0 0	Double Knob	ダブルツマミ	-do.-
21	3 2 0 0 0 0 B A 0 6 9 7 1 0	Knob, Switch	SWツマミ	-do.-
22	3 2 0 0 0 0 B A 0 6 4 4 5 0	-do.-, Tone Control	ツマミ	CR-400,620, 820,2020
23	3 2 0 0 0 0 C B 0 7 9 2 7 0	-do.-, Phono Selector	Phonoツマミ	CR-2020
24	3 2 0 0 0 0 A A 0 8 4 9 4 0	Metal, Warp Prevention	反り止め金具	CR-2020, 620,820
25	3 2 0 0 0 0 C B 0 7 9 3 2 0	Spacer, Warp Prevention	反り止め スペーサー	R,U,C,A
26	3 2 0 0 0 0 C B 0 7 9 2 4 0	Button, Push Switch	プッシュボタン	-do.-
27	3 2 0 0 0 0 A A 0 8 4 9 5 0	Spring, Push Switch	プッシュスプリング	-do.-
28	3 2 0 0 0 0 C B 0 7 9 2 5 0	Button Frame, Push Switch	プッシュボタン枠	-do.-
29	3 2 0 0 0 0 C G 0 6 0 4 5 0	Dial Panel	ダイヤルパネル	CR-2020
30	4 2 0 0 0 0 C B 0 7 9 0 2 0	Film For Aplon	エプロン 受けフィルム	CA-1010 CR-2020
31	4 2 0 0 0 0 C B 0 7 9 1 0 0	-do.-	//	CA-R1 CR-2020
32	3 2 0 0 0 0 B A 0 6 9 6 6 0	Dial Scale	ダイヤル目盛板	CR-2020
33	3 2 0 0 0 0 A A 0 8 4 7 2 0	Sub-Chassis	サブシャーシ	-do.-
34	3 2 0 0 0 0 C B 0 7 9 7 8 0	Knob, Lever Switch	レバーツマミ	-do.-
35	4 2 0 0 0 0 C B 0 7 9 5 0 0	Aplon, Lever Switch	SWエプロン	CA-R1 CR-2020
36	4 2 0 0 0 0 C B 0 7 9 5 1 0	-do.-	//	-do.-
37	3 2 0 0 0 0 C B 0 7 9 7 7 0	Bush, Lever Switch	SWプッシュ	CT-R1 CR-2020
38	3 2 0 0 0 0 C B 0 7 9 2 9 0	Holder For LED	LEDホルダー	CR-2020
39	3 2 0 0 0 0 N A 0 6 8 9 7 4	Pre Circuit Board 4	プリシート 4	
A	4 2 0 0 0 0 H F 0 0 0 6 8 0	LED	LED	
B	3 2 0 0 0 0 C B 0 7 9 3 0 0	Spacer For LED	LEDスペーサー	CR-2020, 620,820
40	3 2 0 0 0 0 C B 0 7 9 2 3 0	Holder For Meters	メーターホルダー	CR-2020
A	3 2 0 0 0 0 C B 0 7 9 3 1 0	Colour Plate	カラープレート	CR-2020, 620,820
41	4 2 0 0 0 0 J i 0 0 0 6 4 0	Level Meter 47B 1mA 650Ω	レベルメーター	
42	4 2 0 0 0 0 J i 0 0 0 6 5 0	Signal Meter -do.-	シグナルメーター	
43	4 2 0 0 0 0 J i 0 0 0 6 7 0	Tuning Meter 47B 250μA 650Ω	チューニング メーター	
44	3 2 0 0 0 0 M Z 0 6 9 5 6 0	Lamp Assembly	ランプAss'y	

Ref. No.	Part No.	Description	Remarks	Common Models
45	4 2 0 0 0 0 K A 2 0 0 6 3 0	Lever Switch	パワースイッチ	R,U,C
	4 2 0 0 0 0 K A 2 0 0 6 8 0	-do.-	//	E
	4 2 0 0 0 0 K A 2 0 0 6 9 0	-do.-	//	B,A
46	4 2 0 0 0 0 F Z 0 0 0 5 4 0	Spark Killer DC500V AC350V 0.033 $\mu$ +120 $\Omega$	スパークキラーコン	R
	4 2 0 0 0 0 F Z 0 0 0 1 1 0	-do.- 0.033 $\mu$ +120 $\Omega$	//	U
	4 2 0 0 0 0 F Z 0 0 0 6 9 0	-do.- 0.022 $\mu$	//	E,B
	4 2 0 0 0 0 F Z 0 0 0 9 5 0	-do.- 0.33 $\mu$ +120 $\Omega$	//	C
A	4 2 0 0 0 0 C B 0 7 2 1 9 0	Cover For Capacitor 820826	コンデンサーカバー	R,U,B,E
	4 2 0 0 0 0 C B 0 7 9 8 9 0	-do.- SB0652a	//	C
47	3 2 0 0 0 0 N A 0 6 9 0 5 1	Headphone Circuit Board 1	ヘッドフォンシート1	
A	4 2 0 0 0 0 L B 3 0 0 5 2 0	Phone Jack LJ190-1-2	フォンジャック	
B	4 2 0 0 0 0 H M 5 3 5 3 3 0	Cement Molded Resistor 3W330 $\Omega$	セメント抵抗	
48	3 2 0 0 0 0 A A 0 8 4 8 6 0	Dial Pointer Rail	ダイヤル指針レール	
49	3 2 0 0 0 0 N B 0 7 8 7 0 0	Dial Pointer Unit	ダイヤル指針	
A	4 2 0 0 0 0 J B 0 0 0 5 1 0	Pilot Lamp UL 12V 60mA	パイロットランプ	
B	3 2 0 0 0 0 A A 0 7 3 6 7 0	Cover For Pointer	指針カバー	CR-400, 620, 820
C	3 2 0 0 0 0 C B 0 6 8 9 5 0	Pointer	ダイヤル指針	CR-620, 820, 2020
D	3 2 0 0 0 0 C B 0 6 8 5 9 0	Holder, Dial Pointer	指針ホルダー	CR-400, 620, 820
E	3 2 0 0 0 0 C B 0 6 8 6 0 0	Colour Plate	指針カラープレート	-do.-
F	4 2 0 0 0 0 E D 0 2 0 0 5 0	Binding Head Screw 2 $\times$ 5 ZMC2-Y	バインド小ネジ	
50	3 2 0 0 0 0 C B 0 7 9 2 8 0	Lead Pipe	リードパイプ	CR-2020
51	3 2 0 0 0 0 C B 0 7 5 8 4 0	Wheel	滑車	CT-1010, CR-620, 820, 2020
52	3 2 0 0 0 0 C B 0 7 7 8 9 0	Pulley Clip	プリークリップ	-do.-
53	3 2 0 0 0 0 N B 0 7 8 1 4 0	Tuning Unit	チューニングユニット	CR-820, 2020
54	3 2 0 0 0 0 C B 0 7 7 8 8 0	Isolation Bush	絶縁ブッシュ	CT-1010, CR-820, 2020
55	4 2 0 0 0 0 C A 0 6 5 1 5 0	Isolation Fiber	絶縁ファイバー	-do.-
56	3 2 0 0 0 0 A A 0 8 4 7 6 0	Shaft Unit, Selector	シャフトユニット	CR-2020
57	4 2 0 0 0 0 K A 5 0 1 0 2 0	Rotary Switch Y-246W	ロータリースイッチ	
58	3 2 0 0 0 0 A A 0 8 4 7 5 0	Switch Stay	SWステイ	CR-2020
59	3 2 0 0 0 0 A A 0 8 4 9 6 0	Holder L, -do.-	// L	
60	3 2 0 0 0 0 A A 0 8 4 9 2 0	Holder R, -do.-	// R	
61	4 2 0 0 0 0 C B 0 6 8 8 8 0	Plastic Rivet $\phi$ 3.5	プラスチックリベット	
62	4 2 0 0 0 0 L A 0 0 1 1 7 0	Lug Terminal $\phi$ 9.5	アースラグ	
63	3 2 0 0 0 0 N A 0 6 9 0 5 2	Headphone Circuit Board 2	ヘッドフォンシート2	
A	4 2 0 0 0 0 I F 0 0 0 6 8 0	LED	LED	
B	3 2 0 0 0 0 C B 0 7 9 3 0 0	Spacer For LED	LEDスペーサー	
64	3 2 0 0 0 0 N A 0 6 8 9 7 2	Pre Circuit Board 2	プリシート2	
A	4 2 0 0 0 0 H S 4 2 0 1 8 0	Variable Resistor 50K $\times$ 2+50K	可変抵抗器	
B	4 2 0 0 0 0 L A 0 0 1 2 8 0	Lapping Pin	ラッピング端子	
65	3 2 0 0 0 0 N A 0 6 9 2 7 2	Tuner Circuit Board 2	チューナーシート2	R
	3 2 0 0 0 0 N A 0 6 8 9 4 2	-do.-	//	U,C
	3 2 0 0 0 0 N A 0 6 8 9 5 2	-do.-	//	A,E,B
A	4 2 0 0 0 0 K A 8 0 0 3 0 0	Push Switch 3 $\times$ 4 $\times$ 3	プッシュスイッチ	R,A,E,B
	4 2 0 0 0 0 K A 8 0 0 2 9 0	-do.- 2 $\times$ 4 $\times$ 3	//	U,C
	4 2 0 0 0 0 K A 8 0 0 2 7 0	-do.- 1 $\times$ 4 $\times$ 3	//	
B	4 2 0 0 0 0 L A 0 0 1 2 8 0	Lapping Pin	ラッピング端子	
C	4 2 0 0 0 0 F S 1 1 3 6 8 0	BL Ceramic Capacitor 50V 0.0068 $\mu$	SBLコン	
66	3 2 0 0 0 0 N A 0 6 8 9 7 3	Pre Circuit Board 3	プリシート3	
A	4 2 0 0 0 0 K A 8 0 0 2 7 0	Push Switch 1 $\times$ 4 $\times$ 3	プッシュスイッチ	
67	3 2 0 0 0 0 N A 0 6 8 9 7 1	Pre Circuit Board 1	プリシート1	
A	4 2 0 0 0 0 K A 5 0 0 6 5 0	Rotary Switch SRZ-V045 NS	ロータリースイッチ	

Ref. No.	Part No.	Description	Remarks	Common Models
	4 2 0 0 0 0 K A 2 0 0 6 7 0	Lever Switch 4×3	レバースイッチ	
B	4 2 0 0 0 0 H S 4 1 0 5 6 0	Variable Resistor B10K×2	可変抵抗器	
	4 2 0 0 0 0 H S 4 1 0 5 4 0	—do.— CT50K×2	//	
C	4 2 0 0 0 0 G D 9 0 0 2 4 0	Coil, Magnetic Shield Type 82mH	コイル	
D	4 2 0 0 0 0 F Z 0 0 0 8 3 0	Electrolytic Cap., MS 47μ6.3V	MSケミコン	
	4 2 0 0 0 0 F A 1 1 3 1 8 0	Mylar Cap. 50VMS 0.0018μ	マイラーコン	
	4 2 0 0 0 0 F A 1 1 3 3 3 0	—do.— 0.0033μ	//	
	4 2 0 0 0 0 F A 1 1 3 8 2 0	—do.— 0.0082μ	//	
	4 2 0 0 0 0 F A 1 1 4 1 0 0	—do.— 0.01μ	//	
	4 2 0 0 0 0 F A 1 1 4 1 2 0	—do.— 0.012μ	//	
	4 2 0 0 0 0 F A 1 1 4 3 3 0	—do.— 0.033μ	//	
	4 2 0 0 0 0 F A 1 1 4 8 2 0	—do.— 0.082μ	//	
	4 2 0 0 0 0 F A 1 1 5 1 5 0	—do.— 0.15μ	//	
	4 2 0 0 0 0 F A 1 1 5 3 9 0	—do.— 0.39μ	//	
	4 2 0 0 0 0 F A 1 1 5 3 3 0	—do.— 0.33μ	//	
	4 2 0 0 0 0 F A 1 1 4 2 7 0	—do.— 0.027μ	//	
	4 2 0 0 0 0 F A 1 1 4 4 7 0	—do.— 0.047μ	//	
	4 2 0 0 0 0 F Z 0 0 1 0 0 0	Metallized Polyester Film Cap. 0.68μ	//	
E	4 2 0 0 0 0 L A 0 0 1 2 8 0	Wire lapping Pin	ラッピング端子	
F	3 2 0 0 0 0 N A 0 6 8 9 8 0	Pre Module C. Board	プリントモジュールシート	CR-2020
a	4 2 0 0 0 0 F A 1 1 3 8 2 0	Mylar Capacitor 0.0082μ 50V	マイラーコン	
	4 2 0 0 0 0 F A 1 1 5 1 0 0	—do.— 0.1μ 50V	//	
	4 2 0 0 0 0 F Z 0 0 0 9 8 0	Electrolytic Cap., RB 10μ 25V	RBケミコン	
b	4 2 0 0 0 0 i A 0 6 7 3 1 0	Transistor 2SA673A C,D	トランジスター	
	4 2 0 0 0 0 i A 0 8 4 4 1 0	—do.— 2SA844 D,E	//	
	4 2 0 0 0 0 i C 1 2 1 3 1 0	—do.— 2SC1213A C,D	//	
	4 2 0 0 0 0 i C 1 7 7 5 1 0	—do.— 2SC1775 D,E	//	
	4 2 0 0 0 0 i C 1 1 7 5 1 0	—do.— 2SC1175NP E,F	//	2SC1213A
	4 2 0 0 0 0 i C 1 5 0 9 3 0	—do.— 2SC1509 Q,R	//	2SD438
	4 2 0 0 0 0 i A 0 7 7 7 3 0	—do.— 2SA777 Q,R	//	2SB560
c	4 2 0 0 0 0 i F 0 0 0 0 4 0	Diode 1S1555	ダイオード	
d	4 2 0 0 0 0 i F 0 0 0 7 9 0	Varistor MV-12R	バリスタ	
e	4 2 0 0 0 0 L B 6 0 1 7 8 0	Connector	コネクタ	
68	4 2 0 0 0 0 E i 0 3 0 0 8 0	Binding Tapping Screw 3×8 ZMC2-Y	バイインド タッピングネジ	
69	4 2 0 0 0 0 E i 0 4 0 0 8 0	—do.— 4×8 ZMC2-Y	//	
70	4 2 0 0 0 0 E i 2 3 0 0 6 0	—do.— 3×6 FCrM3-3g	//	
71	4 2 0 0 0 0 E D 0 3 0 0 6 0	Binding Head Screw 3×6 ZMC2-Y	バイインド小ネジ	
72	4 2 0 0 0 0 E i 0 3 0 0 6 0	Binding Tapping Screw 3×6 ZMC2-Y	バイインド タッピングネジ	



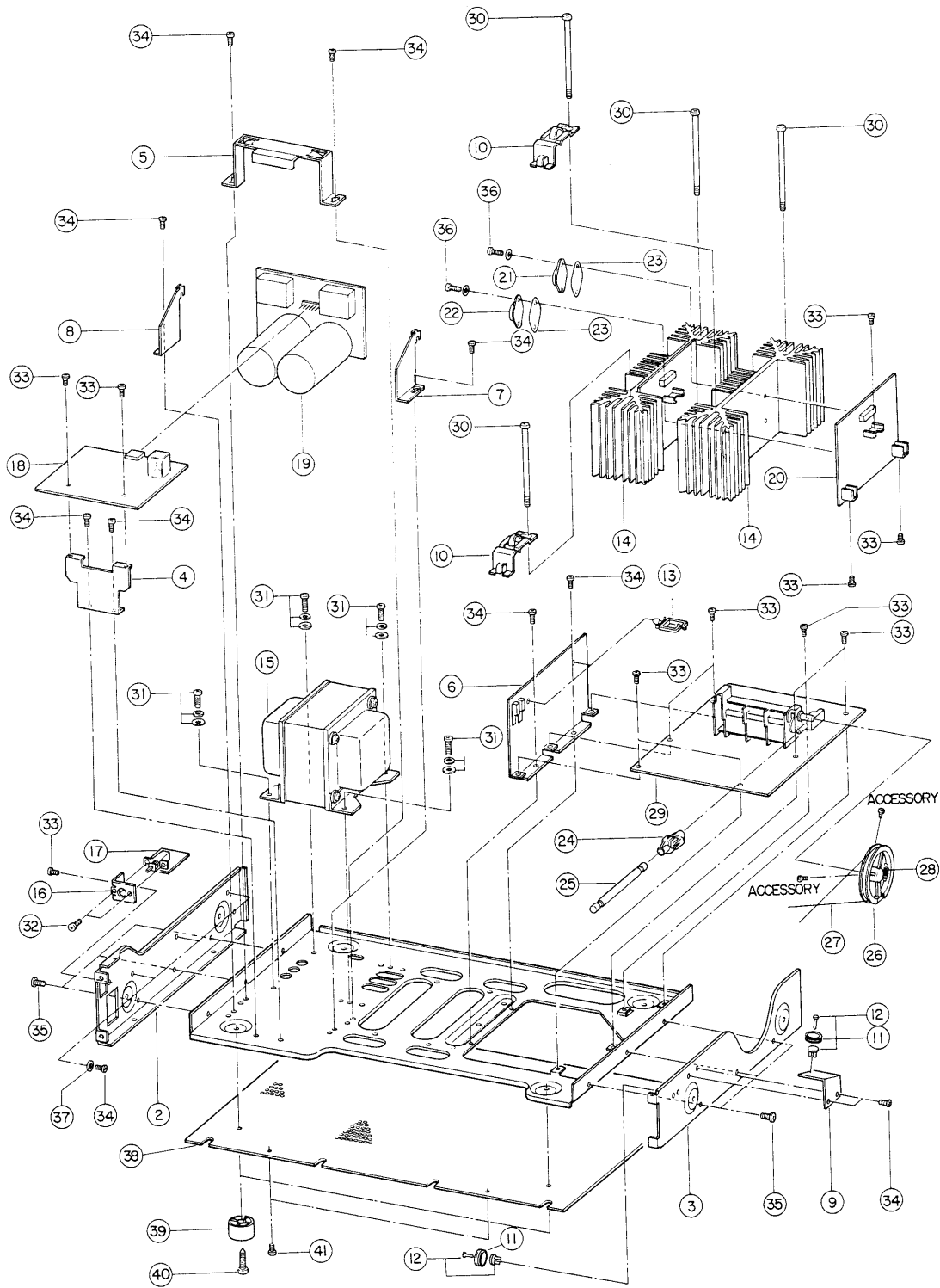

Ref. No.	Part No.	Description	Remarks	Common Models
1	3 2 0 0 0 0 A A 0 8 4 7 1 0	Main-Chassis	メインシャーシ	CR-2020
2	3 2 0 0 0 0 A A 0 8 4 7 3 0	Side Frame, L	サイドフレーム L	-do.-
3	3 2 0 0 0 0 A A 0 8 4 7 4 0	Side Frame, R	サイドフレーム R	-do.-
4	3 2 0 0 0 0 A A 0 8 4 8 3 0	Holder, Power Supply C. Board 1	電源シート1ホルダー	-do.-
5	3 2 0 0 0 0 A A 0 8 5 4 6 0	Holder, Electrolytic Cap.	ケミコンホルダー	
6	3 2 0 0 0 0 A A 0 8 4 8 5 0	Adiabatic Board	断熱板	CR-2020
7	3 2 0 0 0 0 A A 0 8 4 8 8 0	Holder R, Electrolytic Cap. C. Board	シートホルダー R	-do.-
8	3 2 0 0 0 0 A A 0 8 4 8 9 0	Holder L, Electrolytic Cap. C. Board	シートホルダー L	-do.-
9	3 2 0 0 0 0 A A 0 8 4 9 3 0	Holder For Pulley	滑車ホルダー	-do.-
10	3 2 0 0 0 0 A A 0 8 4 8 7 0	Plate For Cord	コード押え	-do.-
11	3 2 0 0 0 0 C B 0 7 5 8 4 0	Pulley	滑車	CR-620,820, 2020, CT-1010
12	3 2 0 0 0 0 C B 0 7 7 8 9 0	Pulley Clip	プーリークリップ	-do.-
13	3 2 0 0 0 0 C B 0 7 9 4 2 0	Wire Supporter	ワイヤークリップ	CR-2020
14	3 2 0 0 0 0 B A 0 6 5 7 5 0	Heat Sink	放熱板	CR-2020 CA-1000II
15	4 2 0 0 0 0 G A 6 1 0 7 2 0	Power Transformer	電源トランス	R,E
	4 2 0 0 0 0 G A 6 1 0 7 4 0	-do.-	//	C
	4 2 0 0 0 0 G A 6 1 0 7 1 0	-do.-	//	U
	4 2 0 0 0 0 G A 6 1 0 7 8 0	-do.-	//	A,B
16	3 2 0 0 0 0 A A 0 8 4 9 0 0	Switch Stay	SW取付金具	CR-2020
17	3 2 0 0 0 0 N A 0 6 8 9 9 2	Power Supply Circuit Board 2	電源シート 2	R,U,C,A
	3 2 0 0 0 0 N A 0 6 9 0 0 2	-do.-	//	E,B
	4 2 0 0 0 0 K A 8 0 0 2 6 0	Push Switch 1X2X3	プッシュSW	
	4 2 0 0 0 0 i C 1 9 1 8 0 0	Transistor 2SC1918	トランジスター	
18	3 2 0 0 0 0 N A 0 6 8 9 9 1	Power Supply Circuit Board 1	電源シート1	R,U,C,A
	3 2 0 0 0 0 N A 0 6 9 0 0 1	-do.-	//	E,B
A	4 2 0 0 0 0 i A 0 6 5 9 1 0	Transistor 2SA659NP E,F	トランジスター	2SA673A,D
	4 2 0 0 0 0 i A 0 8 4 4 1 0	-do.- 2SA844 D,E	//	
	4 2 0 0 0 0 i B 0 5 4 4 0 0	-do.- 2SB544	//	
	4 2 0 0 0 0 i C 1 1 7 5 1 0	-do.- 2SC1175NP E,F	//	2SC1213AC,D
	4 2 0 0 0 0 i C 1 8 9 0 0 0	-do.- 2SC1890 D,E	//	
	4 2 0 0 0 0 i C 1 9 1 8 0 0	-do.- 2SC1918	//	
	4 2 0 0 0 0 i D 0 4 0 0 0 0	-do.- 2SD400	//	
	4 2 0 0 0 0 i D 0 2 3 4 0 0	-do.- 2SD234	//	
B	4 2 0 0 0 0 i F 0 0 0 0 4 0	Diode 1S1555	ダイオード	
	4 2 0 0 0 0 i F 0 0 0 2 4 0	-do.- 1S1885	//	
	4 2 0 0 0 0 i H 0 0 0 4 7 0	-do.- 1D4B1	//	
	4 2 0 0 0 0 i F 0 0 0 6 4 0	Zener Diode HZ-7B	ツェナーダイオード	
	4 2 0 0 0 0 i F 0 0 0 5 5 0	-do.- HZ-12C	//	
C	4 2 0 0 0 0 F H 2 3 4 1 0 0	Ceramic Capacitor 0.01 $\mu$ 500VYZ	セラコン	
	4 2 0 0 0 0 F J 2 5 9 1 0 0	Electrolytic Cap. 1000 $\mu$ 35V	ケミコン	
	4 2 0 0 0 0 F Z 0 0 0 4 5 0	-do.-, Z Type 47 $\mu$ 16V	Zケミコン	
D	4 2 0 0 0 0 H T 1 7 0 0 6 0	Variable Resistor B 2K	半固定抵抗	
	4 2 0 0 0 0 H L 3 1 4 1 5 0	Metal Oxide Film Resistor 15 $\Omega$	酸化膜抵抗	
	4 2 0 0 0 0 H M 5 3 5 1 8 0	Cement Molded Resistor 3P 180 $\Omega$	セメント抵抗	
	4 2 0 0 0 0 H M 0 5 5 1 0 0	-do.- 5W100 $\Omega$	//	
E	4 2 0 0 0 0 K B 0 0 1 0 6 0	Fuse ST-4 1A250V	ヒューズ	R,U,C,A
	4 2 0 0 0 0 K B 0 0 0 7 3 0	-do.- ⑤ 1A250V	//	E,B
F	4 2 0 0 0 0 K C 0 0 0 3 5 0	Relay HC-2P 12V80mA	リレー	
G	4 2 0 0 0 0 L A 0 0 0 5 3 0	Eyelet	ハトメ	
H	4 2 0 0 0 0 L B 2 0 0 9 0 0	Fuse Holder	ヒューズホルダー	R,U,C,A
	4 2 0 0 0 0 L B 2 0 1 0 6 0	-do.-		E,B

Ref. No.	Part No.		Description	Remarks	Common Models
I	4 2 0 0 0 0	L B 6 0 0 2 8 0	Connector Socket	コネクター	
J	4 2 0 0 0 0	L A 0 0 1 2 8 0	Wire Lapping Pin	ラッピング端子	
K	3 2 0 0 0 0	B A 0 6 9 7 3 0	Radiator	放熱板	
19	3 2 0 0 0 0	N A 0 6 9 0 4 0	Electrolytic Cap. C. Board	ケミコンシート	R,C,A,E,B
	3 2 0 0 0 0	N A 0 6 9 0 2 0	-do.-	//	U
A	4 2 0 0 0 0	i H 0 0 0 2 5 0	Diode 1S1886	ダイオード	
	4 2 0 0 0 0	i H 0 0 0 5 0 0	-do.- SS-5	//	S5151
	4 2 0 0 0 0	i H 0 0 0 5 1 0	-do.- SS-5R	//	S5151R
	4 2 0 0 0 0	i H 0 0 0 4 7 0	-do.- ID4B1	//	
B	4 2 0 0 0 0	F H 2 3 4 1 0 0	Ceramic Capacitor 0.01 $\mu$ 500V	セラコン	
	4 2 0 0 0 0	F J 2 6 9 1 0 0	Electrolytic Cap. 1000 $\mu$ 50V	ケミコン	
	4 2 0 0 0 0	F Z 0 0 0 8 1 0	-do.-, Lug Type 15000 $\mu$ 63V	ケミコンラグ型	
C	4 2 0 0 0 0	H L 3 2 6 4 7 0	Metal Oxide Film Resistor 2P4.7K $\Omega$	酸化抵抗	
	4 2 0 0 0 0	H L 4 2 4 1 0 0	-do.- 2P10 $\Omega$	//	
	4 2 0 0 0 0	H W 1 0 4 2 2 0	Fuse Resistor 150mA22 $\Omega$	ヒューズ抵抗	R,A,E,C,B
	4 2 0 0 0 0	H W 2 0 4 2 2 0	-do.-	//	U
	4 2 0 0 0 0	H W 1 0 4 1 0 0	-do.- 220mA10 $\Omega$	//	R,A,E,C,B
	4 2 0 0 0 0	H W 2 0 4 1 0 0	-do.-	//	U
D	4 2 0 0 0 0	L A 0 0 0 5 3 0	Eyelet With Wing	羽根付ハトメ	
	4 2 0 0 0 0	L B 6 0 1 7 6 0	6P Connector, C. Board Type	コネクターピン	
20	3 2 0 0 0 0	N A 0 6 8 9 1 0	Main Circuit Board	メインシート	R,A
	3 2 0 0 0 0	N A 0 6 8 8 5 0	-do.-	//	U
	3 2 0 0 0 0	N A 0 6 8 8 9 0	-do.-	//	C
	3 2 0 0 0 0	N A 0 6 8 9 0 0	-do.-	//	E,B
A	4 2 0 0 0 0	i A 0 5 6 1 7 0	Transistor 2SA561 O~Y	トランジスター	
	4 2 0 0 0 0	i A 0 8 4 4 0 0	-do.- 2SA844	//	
	4 2 0 0 0 0	i A 0 8 7 2 0 0	-do.- 2SA872	//	
	4 2 0 0 0 0	i C 0 4 5 8 8 0	-do.- 2SC458 B,C	//	
	4 2 0 0 0 0	i C 0 7 3 4 3 0	-do.- 2SC734 O~Y	//	
	4 2 0 0 0 0	i C 1 6 2 8 0 0	-do.- 2SC1628 O~Y	//	
	4 2 0 0 0 0	i C 1 9 1 8 0 0	-do.- 2SC1918 E,F,G	//	
	4 2 0 0 0 0	i A 0 7 4 3 9 0	-do.- 2SA743 B	//	
	4 2 0 0 0 0	i C 1 2 1 2 9 0	-do.- 2SC1212 B	//	
B	4 2 0 0 0 0	i F 0 0 0 0 4 0	Diode 1S1555	ダイオード	
	4 2 0 0 0 0	i F 0 0 0 5 7 0	Zener Diode Hz-6C	ツェナーダイオード	
C	4 2 0 0 0 0	F C 0 2 5 1 0 0	Mylar Capacitor 0.1 $\mu$ 100V	マイラーコン	
	4 2 0 0 0 0	F H 2 3 4 1 0 0	Ceramic Cap. 0.01 $\mu$ 500V	セラコン	
	4 2 0 0 0 0	F H 6 1 0 6 0 0	-do.- 6P500V	//	
	4 2 0 0 0 0	F H 6 1 1 2 2 0	-do.- 22P500V	//	
	4 2 0 0 0 0	F H 6 1 1 4 7 0	-do.- 47P500V	//	
	4 2 0 0 0 0	F Z 0 0 0 9 8 0	Electrolytic Cap., RB 10 $\mu$ 25V	RBケミコン	
D	4 2 0 0 0 0	H T 4 1 0 1 5 0	Variable Resistor B4.7K	ソリッドVR	
	4 2 0 0 0 0	H L 4 1 6 1 5 0	Metal Oxide Film Resistor 1P 1.5K $\Omega$	酸化抵抗	
	4 2 0 0 0 0	H L 6 2 6 1 5 0	-do.- 2P1.5K $\Omega$	//	
	4 2 0 0 0 0	H L 6 2 6 2 7 0	-do.- 2P2.7K $\Omega$	//	
	4 2 0 0 0 0	H M 0 5 2 4 7 0	Cement Molded Resistor 5P0.47 $\Omega$	セメント抵抗	
	4 2 0 0 0 0	H M 0 5 4 1 0 0	-do.- 5P10 $\Omega$	//	
	4 2 0 0 0 0	H M 0 5 6 2 2 0	Cement Molded Resistor 5P2.2K $\Omega$	//	
	4 2 0 0 0 0	H Z 0 0 0 7 1 0	Fire Proof Resistor 1P4.7 $\Omega$	不燃性抵抗	
	4 2 0 0 0 0	H W 1 1 4 6 8 0	Fuse Resistor 100mA68 $\Omega$	ヒューズ抵抗	R,C,B,A,E
	4 2 0 0 0 0	H W 2 1 4 6 8 0	-do.-	//	U

Ref. No.	Part No.	Description	Remarks	Common Models
E	4 2 0 0 0 0 G D 9 0 0 2 1 0	Coil 2.0 $\mu$ H	コイル	
F	4 2 0 0 0 0 K B 0 0 0 5 9 0	Fuse, $\text{\textcircled{S}}$ 5A250V	$\text{\textcircled{S}}$ ヒューズ	B,E
	4 2 0 0 0 0 K B 0 0 1 1 0 0	-do.- UL 5A250V	ULヒューズ	R,U,C,A
G	3 2 0 0 0 0 B A 0 6 9 5 5 0	Radiator	放熱板	CA-R1 CR-2020
	3 2 0 0 0 0 B A 0 6 9 6 7 0	-do.-	//	CR-2020
H	3 2 0 0 0 0 B B 0 6 3 0 8 0	TR-Pusher	トランジスター プッシャー	CR-620,820, 2020,CA-1000II
I	4 2 0 0 0 0 L A 0 0 0 3 7 0	Pipe-Lug Terminal	パイブラグ	
	4 2 0 0 0 0 L A 0 0 0 5 3 0	Eyelet With Wing	羽根付ハトメ	
	4 2 0 0 0 0 L A 0 0 0 6 4 0	Eyelet	ハトメ	
J	4 2 0 0 0 0 L B 2 0 0 9 0 0	Fuse Holder Pin YSP402P	ヒューズ ホルダーピン	R,U,C,A
	4 2 0 0 0 0 L B 2 0 1 0 6 0	-do.- YSH403P	//	B,E
K	4 2 0 0 0 0 L B 3 0 0 1 1 0	Transistor Socket SZ-110B-00	トランジスター ソケット	R,B,A,E
	4 2 0 0 0 0 L B 3 0 0 2 7 0	-do.- SZ-110M-OL	//	U,C
21	4 2 0 0 0 0 i B 0 5 5 5 0 0	Transistor 2SB555 R-O	トランジスター	
22	4 2 0 0 0 0 i D 0 4 2 5 0 0	-do.- 2SD425 R-O	//	
23	4 2 0 0 0 0 i L 0 0 0 2 3 0	Isolation Base, Mica	マイカベース	
24	3 2 0 0 0 0 B A 0 6 9 7 2 0	Shaft	延長シャフト	CR-2020
25	3 2 0 0 0 0 C B 0 7 7 9 4 0	Joint	ジョイント	CR-2020,820, 620,CA-1010
26	3 2 0 0 0 0 C B 0 7 9 2 6 0	V.C Pulley	バリコンプーリー	CR-620, 820,2020
27	4 2 0 0 0 0 C B 0 7 7 0 7 0	Dial String $\phi$ 0.39 $\times$ 1.6m	ダイヤル糸	
28	3 2 0 0 0 0 A A 0 8 0 5 3 0	Dial Spring	ダイヤル スプリング	CR-620,820, 2020,450
29	3 2 0 0 0 0 N A 0 6 9 2 7 1	Tuner Circuit Board 1	チューナーシート1	R
	3 2 0 0 0 0 N A 0 6 8 9 4 1	-do.-	//	U,C
	3 2 0 0 0 0 N A 0 6 8 9 5 1	-do.-	//	A,E,B
A	4 2 0 0 0 0 P A 0 0 0 3 7 0	RF Pack FB623U	パック	CR-2020
B	4 2 0 0 0 0 G E 1 0 0 1 5 0	OSC Coil	OSCコイル	
	4 2 0 0 0 0 G E 1 0 0 1 8 0	FM IFT	FM IFT	
	4 2 0 0 0 0 G E 1 0 0 2 0 0	FM Discriminator Coil	FMディスクリ コイル	
	4 2 0 0 0 0 G E 2 0 0 0 7 0	MPX Coil	MPXコイル	
	4 2 0 0 0 0 G E 2 0 0 1 6 0	-do.- 22mH	MPX固定コイル	
	4 2 0 0 0 0 G E 3 0 0 1 3 0	RF Inductor Coil 10 $\mu$ H	RFインダクター	
	4 2 0 0 0 0 G E 3 0 0 1 5 0	-do.- 8.2mH	//	
C	4 2 0 0 0 0 G G 0 0 0 8 0	Ceramic Filter FSN1067	セラミック フィルタ	
	4 2 0 0 0 0 G G 0 0 0 1 7 0	-do.- CFM-107M-12C	//	
D	4 2 0 0 0 0 F A 1 5 3 1 0 0	Mylar Capacitor(J) 0.001 $\mu$ 50V	マイラーコン	
	4 2 0 0 0 0 F A 1 5 4 1 5 0	-do.- (J) 0.015 $\mu$ 50V	//	A,E,B
	4 2 0 0 0 0 F A 1 5 4 2 2 0	-do.- (J) 0.022 $\mu$ 50V	//	R,U,C
	4 2 0 0 0 0 F A 1 1 3 1 0 0	-do.- 0.001 $\mu$ 50V	//	
	4 2 0 0 0 0 F A 1 1 3 4 7 0	-do.- 0.0047 50V	//	
	4 2 0 0 0 0 F D 1 5 2 8 2 0	Polystyrene Cap. (J) 820P	スチコン	
	4 2 0 0 0 0 F D 1 5 2 2 2 0	-do.- (J) 220P	//	
	4 2 0 0 0 0 F E 1 5 2 3 3 0	-do.- (J) 330P	//	
	4 2 0 0 0 0 F E 1 5 3 1 6 0	-do.- (J) 1600P	//	
	4 2 0 0 0 0 F E 1 5 4 1 0 0	-do.- (J) 10000P	//	
	4 2 0 0 0 0 F S 1 1 3 6 8 0	BL Ceramic Cap. 0.0068 $\mu$ 50V	SBLコン	
	4 2 0 0 0 0 F S 1 1 4 1 5 0	-do.- 0.015 $\mu$ 50V	//	
	4 2 0 0 0 0 F S 1 3 4 4 7 0	-do.- 0.047 $\mu$ 50V	//	
	4 2 0 0 0 0 F Z 0 0 0 9 8 0	Electrolytic Cap., RB 10 $\mu$ 25V	RBケミコン	
	4 2 0 0 0 0 F Z 0 0 0 7 2 0	UPF Cap. 0.015 $\mu$ 100V	UPFコン	
	4 2 0 0 0 0 F Z 0 0 0 7 3 0	-do.- 0.056 $\mu$ 100V	UPFコン	
	4 2 0 0 0 0 F J 5 4 6 2 2 0	Electrolytic Cap., KU 2.2 $\mu$ 25V	ケミコンKU	

Ref. No.	Part No.		Description		Remarks	Common Models
	4 2 0 0 0 0	F M 4 2 5 6 8 0	Electrolytic Cap., Z 0.68 $\mu$ 50V	Zケミコン		
E	4 2 0 0 0 0	H T 1 7 0 0 2 0	Variable Resistor B10K	半固定抵抗		
	4 2 0 0 0 0	H T 1 7 0 0 3 0	-do.- B100K	//		
	4 2 0 0 0 0	H T 1 7 0 0 4 0	-do.- B500	//		
	4 2 0 0 0 0	H T 1 7 0 0 7 0	-do.- B3K	//		
	4 2 0 0 0 0	H U 5 7 6 4 7 0	Metal Film Resistor(F) 4.7K	金属被膜抵抗		
	4 2 0 0 0 0	H U 5 7 7 5 6 0	-do.- 56K	//		
F	4 2 0 0 0 0	i A 0 6 7 3 1 0	Transistor 2SA673A C,D	トランジスター		
	4 2 0 0 0 0	i A 0 8 4 4 0 0	-do.- 2SA844 D,E	//		
	4 2 0 0 0 0	i B 0 5 6 0 0 0	-do.- 2SB560	//		
	4 2 0 0 0 0	i C 1 2 1 3 1 0	-do.- 2SC1213A C,D	//		
	4 2 0 0 0 0	i C 1 7 7 5 0 0	-do.- 2SC1775 D,E	//		
	4 2 0 0 0 0	i C 1 9 1 8 0 0	-do.- 2SC1918 C,D,E	//		
	4 2 0 0 0 0	i D 0 4 3 8 0 0	-do.- 2SD438	//		
	4 2 0 0 0 0	i E 1 0 0 5 0 0	FET 2SK68A	FET		
G	4 2 0 0 0 0	i F 0 0 0 0 4 0	Diode 1S1555	ダイオード		
	4 2 0 0 0 0	i F 0 0 0 6 4 0	Zener Diode HZ-7B	ツェナーダイオード		
H	4 2 0 0 0 0	i G 0 0 0 3 9 0	IC $\mu$ PC577H	IC		
	4 2 0 0 0 0	i G 0 0 1 2 2 0	-do.- TA7136P	//		
	4 2 0 0 0 0	i G 0 0 1 2 3 0	-do.- LA3350	//		
I	4 2 0 0 0 0	K A 5 0 1 0 1 0	Rotary Switch SRZ-V042	ロータリースイッチ		
J	4 2 0 0 0 0	L B 4 0 0 3 1 0	4P Pin-Jack	ピンジャック		
K	4 2 0 0 0 0	L A 0 0 1 2 4 0	Eyelet 3 $\times$ 1.6 $\times$ 3	ハトメ		
L	4 2 0 0 0 0	L A 0 0 1 2 8 0	Wire Lapping Pin	ラッピング端子		
30	4 2 0 0 0 0	E A 4 5 0 9 6 0	Pan Head Screw 5 $\times$ 96 FCM3-B1	ナベ小ネジ		
31	4 2 0 0 0 0	E H 0 4 0 1 0 0	Pan Head Sems Type Screw <sup>3Pieces</sup> 4 $\times$ 10ZMC2-Y	セムスナベ小ネジ		
32	4 2 0 0 0 0	E D 0 3 0 0 6 0	Binding Head Screw 3 $\times$ 6 ZMC2-Y	バインド小ネジ		
33	4 2 0 0 0 0	E i 0 3 0 0 8 0	Binding Tapping Screw 3 $\times$ 8 ZMC2-Y	バインド タッピングネジ		
34	4 2 0 0 0 0	E i 0 3 0 0 6 0	-do.- 3 $\times$ 6 ZMC2-Y	//		
35	4 2 0 0 0 0	E i 0 4 0 0 8 0	-do.- 4 $\times$ 8 ZMC2-Y	//		
36	4 2 0 0 0 0	E Z 3 3 0 1 4 0	BW Head Screw 3 $\times$ 14 FNM3-3M	BWヘッド小ネジ		
37	4 2 0 0 0 0	E V 2 0 0 0 3 0	Flat Washer 3S ZMC2-Y	平座金ミガキ丸		
38	3 2 0 0 0 0	A A 0 8 4 8 1 0	Bottom Cover	ボトムカバー	E,B	CR-1020
39	4 2 0 0 0 0	C B 0 7 9 4 9 0	Leg	脚	E,B	-do.-
40	4 2 0 0 0 0	E J 0 4 0 1 4 0	Pan Head Tapping Screw 4 $\times$ 14 ZMC2-Y	ナベタッピングネジ	E,B	
41	4 2 0 0 0 0	E D 0 3 0 0 8 0	Binding Tapping Screw 3 $\times$ 8 ZMC2-Y	バインド タッピングネジ	E,B	

GENERAL MODEL

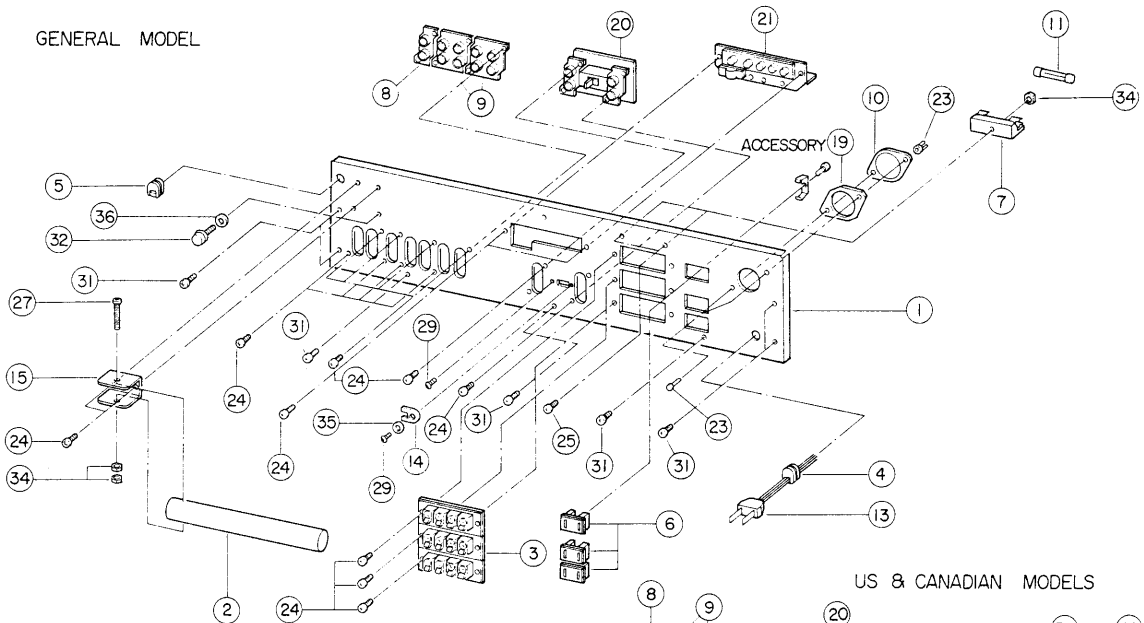

US & CANADIAN MODELS

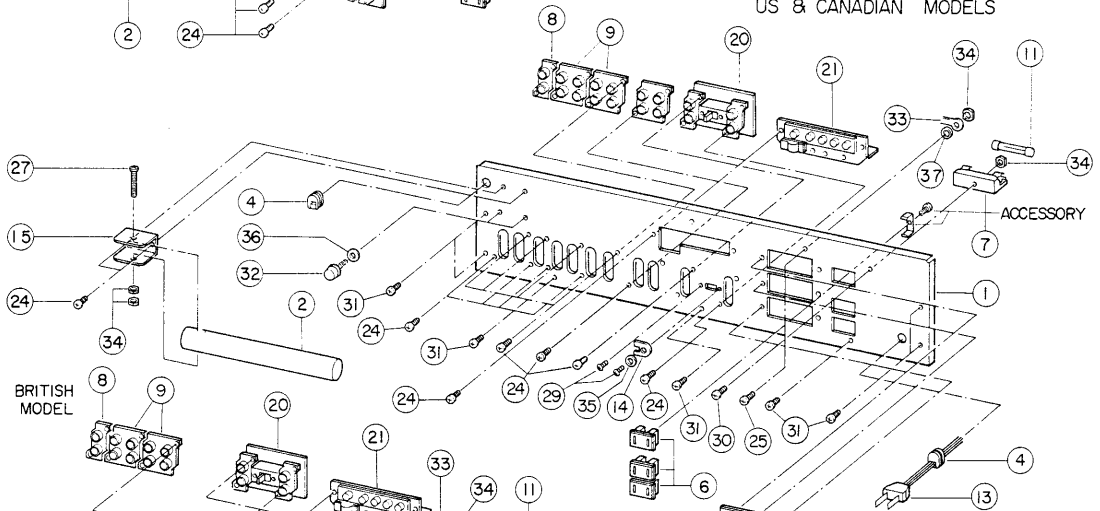

EXCEPT BRITISH MODEL

EUROPEAN MODELS

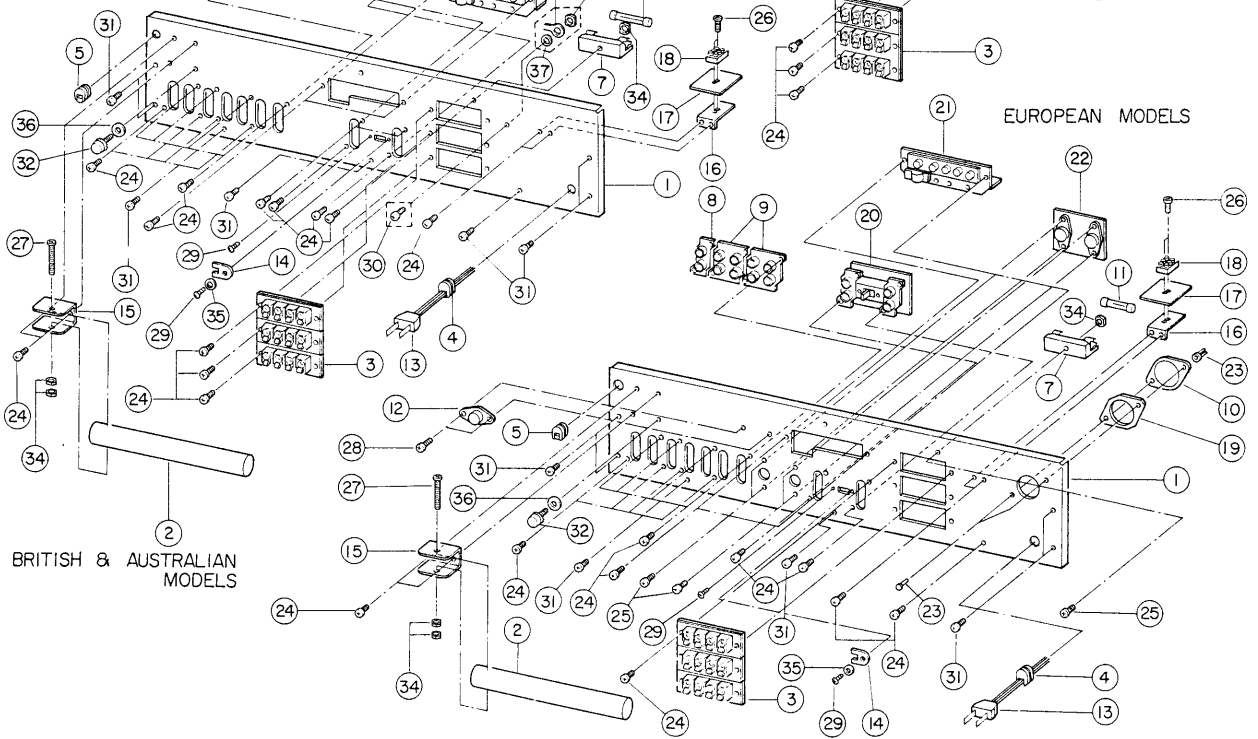

BRITISH & AUSTRALIAN MODELS

Ref. No.	Part No.	Description	Remarks	Common Models
1	3 2 0 0 0 0 A A 0 8 4 9 7 0	Rear Panel	リアパネル	R
	3 2 0 0 0 0 A A 0 8 6 1 0 0	--do.--	//	C
	3 2 0 0 0 0 A A 0 8 4 9 8 0	--do.--	//	U
	3 2 0 0 0 0 A A 0 8 4 9 9 0	--do.--	//	A
	3 2 0 0 0 0 A A 0 8 5 0 0 0	--do.--	//	E
	3 2 0 0 0 0 A A 0 8 5 5 3 0	--do.--	//	B
2	4 2 0 0 0 0 G E 0 0 0 1 0 0	AM Bar Antenna	AMバーアンテナ	
3	4 2 0 0 0 0 L A 0 0 1 9 4 0	4P-Push Terminal	4Pプッシュターミナル	
4	4 2 0 0 0 0 C B 0 6 8 6 3 0	Cord Stopper SR-3P-4	コードストッパー	R,U,C
	4 2 0 0 0 0 C B 0 7 0 6 9 0	--do.-- EA-5	//	A,E,B
5	3 2 0 0 0 0 C B 0 6 2 7 8 0	Rubber Spacer	ゴムブッシュ	R,A,E,B
				CR-2020, 620,820
6	4 2 0 0 0 0 L B 2 0 0 7 1 0	AC Socket S-16428	ACコンセント	R,U,C
7	4 2 0 0 0 0 L B 2 0 0 8 4 0	Fuse Holder 1PFH	ヒューズホルダー	R,U,C,A
	4 2 0 0 0 0 L B 2 0 0 9 4 0	--do.-- 1PFH-M	//	E,B
8	4 2 0 0 0 0 L B 2 0 0 8 8 0	2P-Pin Jack	2Pピンジャック	
9	4 2 0 0 0 0 L B 4 0 0 1 6 0	4P-Pin Jack	4Pピンジャック	
10	4 2 0 0 0 0 L B 2 0 0 2 6 0	Voltage Selector SW033-3023	電圧切換器	R,E
11	4 2 0 0 0 0 K B 0 0 0 4 2 0	Fuse 2.5AT 250V	ヒューズ	R,A
	4 2 0 0 0 0 K B 0 0 0 6 9 0	Fuse, Ⓢ 2.5AT 250V	Ⓢヒューズ	E,B
	4 2 0 0 0 0 K B 0 0 1 1 0 0	Fuse, UL 5A125V	ULヒューズ	U,C
12	4 2 0 0 0 0 L B 2 0 0 1 5 0	75Ω Coaxial Cable Socket	75Ω同軸コネクター	E
13	4 2 0 0 0 0 M G 0 0 0 3 4 0	Power Cord	電源コード	R,U,C
	4 2 0 0 0 0 M G 0 0 0 5 0 0	--do.--	//	A
	4 2 0 0 0 0 M G 0 0 0 4 6 0	Power Cord Assembly	//	B
				All of Modes
14	3 2 0 0 0 0 C B 0 6 8 6 8 0	Stopper, Coupler Switch	カブラーストッパー	
				CR-2020 CA-1000
15	3 2 0 0 0 0 A A 0 7 6 9 7 0	Antenna Holder	アンテナホルダー	
				CR-2020,820 620,MS-2B
16	3 2 0 0 0 0 A A 0 8 4 6 2 0	Stay, 3P-Terminal	端子ステイ	A,E,B
				CR-2020 CA-R1
17	3 2 0 0 0 0 C B 0 7 4 9 7 0	Isolation Plate	絶縁板	A,E,B
				CR-400,620, 820,2020
18	4 2 0 0 0 0 L A 0 0 1 0 4 0	Board, 3P-Terminal	3P中継端子台	A,E,B
19	3 2 0 0 0 0 C B 0 7 6 5 6 0	Isolation Plate For V.Select.	VS絶縁板	R,E
				CR-2020,620, 820,CA-800II
20	3 2 0 0 0 0 N A 0 6 9 0 6 2	Coupler Circuit Board 2	カブラーシート2	
A	4 2 0 0 0 0 G E 3 0 0 0 7 0	Balloon Transformer	バルーントランス	
B	4 2 0 0 0 0 L A 0 0 1 9 5 0	Antenna Terminal	アンテナ端子	
C	4 2 0 0 0 0 L A 0 0 1 2 8 0	Wire Lapping Pin	ラッピング端子	
21	3 2 0 0 0 0 N A 0 6 9 0 6 1	Coupler Circuit Board 1	カブラーシート1	
A	4 2 0 0 0 0 K A 4 0 0 2 1 0	Slide Switch	スライドスイッチ	
B	4 2 0 0 0 0 L B 2 0 0 9 6 0	2P-Pin Jack	2Pピンジャック	
C	4 2 0 0 0 0 L A 0 0 0 4 3 0	Eyelet	ハトメ	
22	3 2 0 0 0 0 N A 0 6 9 0 8 0	Din Circuit Board	Dinシート	E
A	4 2 0 0 0 0 L B 5 0 0 1 9 0	Din Socket	Dinソケット	E
B	4 2 0 0 0 0 L A 0 0 0 4 3 0	Eyelet	ハトメ	E
23	4 2 0 0 0 0 C B 0 6 8 8 8 0	Plastic Rivet	プラスチックリベット	R,E
24	4 2 0 0 0 0 E i 4 3 0 0 8 0	Binding Tapping Screw 3×8 FCM3-B1	バインドタッピングネジ	
25	4 2 0 0 0 0 E D 4 3 0 0 8 0	Binding Head Screw 3×8 FCM3-B1	バインド小ネジ	
26	4 2 0 0 0 0 E D 0 3 0 1 6 0	--do.-- 3×16 ZMC2-Y	//	
27	4 2 0 0 0 0 E A 4 3 0 2 5 0	Pan Head Screw 3×25 FCM3-B1	ナベ小ネジ	
28	4 2 0 0 0 0 E J 4 2 6 0 8 0	Pan Head Tapping Screw 2.6×8 FCM3-B1	ナベタッピングネジ	
29	4 2 0 0 0 0 E C 4 2 6 0 4 0	Oval Head Screw 2.6×4 FCM3-B1	トラス小ネジ	
30	4 2 0 0 0 0 E i 0 3 0 0 8 0	Binding Tapping Screw(C-1) 3×8 FCM3-B1	バインドタッピングネジ	
31	4 2 0 0 0 0 E Z 0 0 0 4 6 0	Bonding Tapping Screw 3×8 FCM3-B1	ボンディングタッピングネジ	
32	4 2 0 0 0 0 L A 0 0 1 0 7 0	Earth Terminal	アース端子	





