

STEREO PRE-AMPLIFIER

SPEC-1

OPERATING INSTRUCTIONS

D

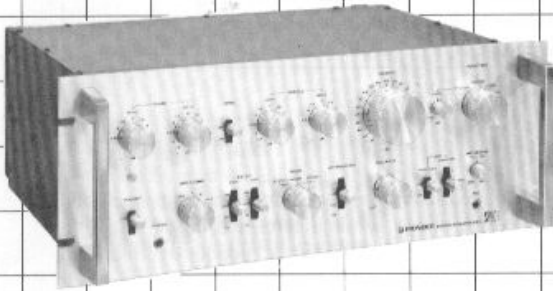

SPEC-1 is designed to operate from 120V, 220V or 240V main. Before turning on the power, please confirm the line voltage setting indicated on the side of your unit corresponds to the supply voltage in your area; if not, change the setting as described in IMPORTANT-LINE VOLTAGE on page 16.

 PIONEER®

CONTENTS

Features	2	Using Microphone	11
Stereo System Set-up	3	Using Tape Decks	12
Connection Diagram	4	Effective Operation	13
Connections	5	Conditions Frequently Mistaken for Malfunction	15
Speaker Systems	6	Important—Line Voltage	16
Front Panel Facilities	8	Specifications, SPEC-1 Characteristics, Installing in Rack and Circuit Diagram Diagram	Insertion
Before Operating	10		
Basic Operation	10		

FEATURES

Circuitry Composed for Outstanding DC Balance

Differential amplifier circuitry is incorporated in the equalization and tone control amplifiers. This is complemented by a dual positive and negative power supply system for all amplifier sections, which provides improved DC balance and stability, while eliminating click noises due to switching. An electronic muting circuit, employing a reed relay, blocks surge noise associated with power switch operation.

Close Tolerance RIAA Equalization

Ultra precision grade vapor deposited metallized film resistors ($\pm 1\%$ tolerance) and styrol capacitors ($\pm 2\%$ tolerance) are combined in the NFB elements to suppress RIAA deviation to $\pm 0.2\text{dB}$ in the 30Hz to 15,000Hz frequency band. High stability at low frequencies is also promoted by the differential amplifier first stage, three stage direct coupled Class A SEPP circuit design. The dual polarity power supply system greatly increases the acceptable input level. This allows high output phono cartridges to be used and even vigorous record passages to be enjoyed with negligible distortion.

Precision Tone Control Facilities

Developed by Pioneer, the twin tone control circuit provides independent ultra-low and ultra-high subcontrols in addition to conventional bass and treble controls. Extremely delicate tone adjustments are made possible which can be used to compensate for listening room acoustics and frequency response characteristics of the speaker systems and phono cartridge. A convenient TONE switch is also included for bypassing the tone control circuits to obtain a flat frequency response whenever desired. This feature is useful for evaluating tone control effectiveness.

Built-in Microphone Mixing Circuit

A microphone mixing circuit is included together with a control for adjusting the volume ratio between microphone and program sources. Versatility is thus broadened to such applications as live explanations during record concerts,

paging when records or tapes are being used for background music in coffee shops or similar relaxed mood establishments, and live singing with a previously recorded melody.

Pre-amplifier Equipped with Speaker Selector

The speaker system outputs of a power amplifier can be routed through the SPEC-1, then from the SPEC-1 to the speaker systems. If two sets of stereo speaker systems are connected in this manner, each set can then be selected individually or simultaneously by an easily operated front panel switch. The SPEC-1 is truly an audio control center that meets the demands of discriminating high fidelity enthusiasts for new and high quality equipment.

Convenient Operating Functions

PHONO 2 LEVEL Control: Input sensitivity at the PHONO 2 jacks can be adjusted from 2.5mV to 10mV (0dB to -12dB). This permits a turntable with a high output phono cartridge to be connected and its level adjusted to match that of other program sources.

VOLUME Control and ATTENUATOR Switch: The VOLUME control is actually a precision attenuator, with coarse attenuations of -15dB and -30dB selectable by a separate ATTENUATOR switch. Volume adjustment when listening at low sound levels or employing a high gain power amplifier are then easily performed.

TAPE DUPLICATE Switch: By connecting two tape decks, the desired programs from a previously recorded tape can be edited onto a second tape, or converted from open reel to convenient cassettes.

Professional Front Panel Design

The wide front panel has been designed for the operational convenience appropriate to high grade system equipment. In addition to lending an impressive appearance in a conventional audio equipment cabinet, the SPEC-1 can also be directly mounted in an EIA standard rack.

STEREO SYSTEM SET-UP

INSTALLATION PRECAUTIONS

When installing the SPEC-1, avoid the following locations which may lead to reduced performance or malfunctions.

- In direct sunlight, near radiators or other heat sources.

- Locations with poor ventilation, and those subject to excessive humidity or dust.
- Unstable or unlevel surfaces.
- Near alcohols, insect sprays or other inflammable materials.

THICK CURTAINS

- Shield from direct sunlight.
- Adjust position and coverage area to control excess sound liveliness in the listening room.

CABINET

- Sturdy composition, durable against weight and vibration.

TAPE DECK

- Be sure to set reel clamps when using.
- Close dust cover when not employing.

TURNTABLE

- Observe that vibrations are not transferred to turntable.
- Keep dust cover closed whenever possible.

- With the left and right speaker systems taken as the base line, the listening position should be slightly to the rear of an equilateral triangle formed with the speakers.

- Sound quality is influenced by furniture composition and distribution.

SPEC-1 (Pre-amplifier)

- Do not use longer connecting cords than necessary.

SPEC-2 (Power Amplifier)

- Observe that speaker connecting cords possess adequate power handling capacity.

TUNER

- Employ an outdoor FM antenna for best reception.

SPEAKER SYSTEMS

- Rear and side panels of both left and right speaker systems should be at the same conditions. (Low frequencies emerge more easily when the rear panel is in proximity to a wall.)

STORAGE AREA

- Protected from dust and grit.
- Store records vertically
- Do not leave recorded tape exposed for extended periods.
- Protect tape from magnetic fields

CARPET

- Effective when placed in front of speaker systems.
- Improves sound absorption.

Install speaker systems so that vibrations are not transferred to the floor.

- For bookshelf type systems, use supporting stands or concrete blocks.

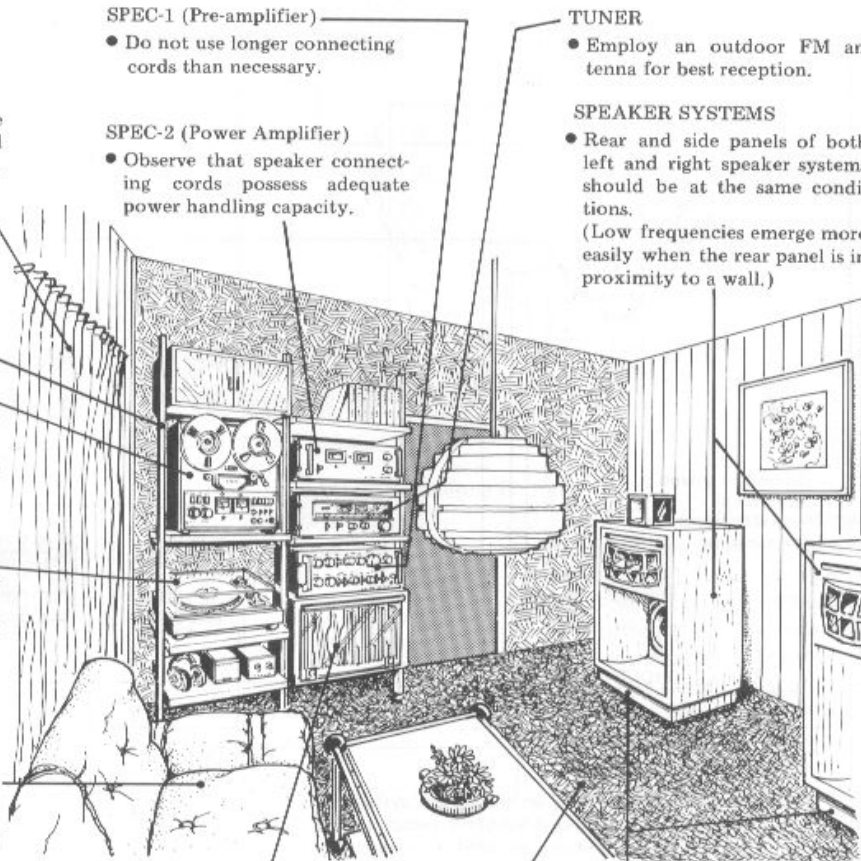

CONNECTION DIAGRAM

STEREO SYSTEM SET UP

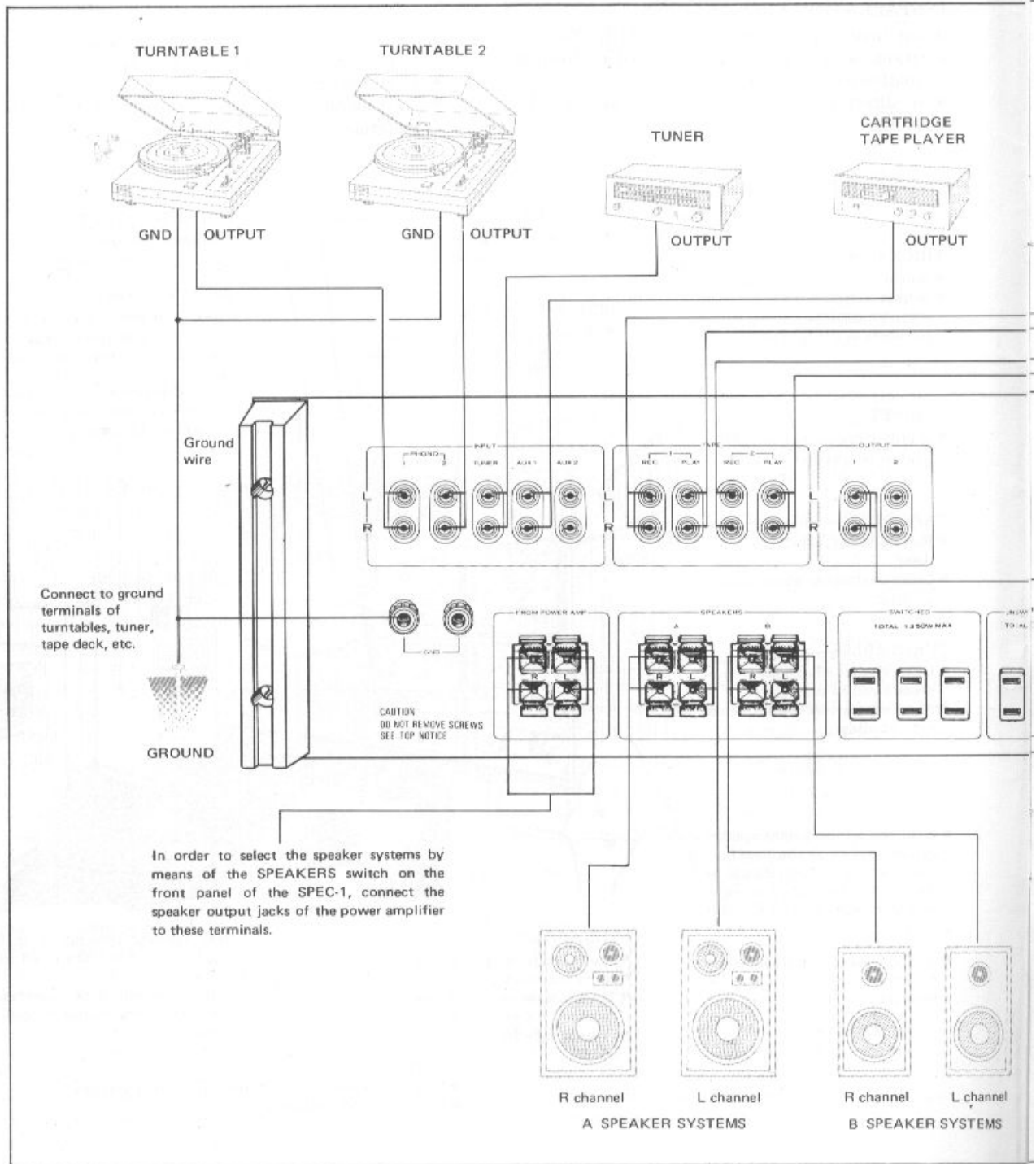

CONNECTIONS

POWER AMPLIFIER

As shown in Fig. 1, use the accessory connecting cords to connect the OUTPUT 1 jacks of the SPEC-1 with the INPUT jacks of a power amplifier. When employing two power amplifiers, connect the second unit to the OUTPUT 2 jacks. Upper jacks are for the left (L) channel and lower jacks for the right (R) channel.

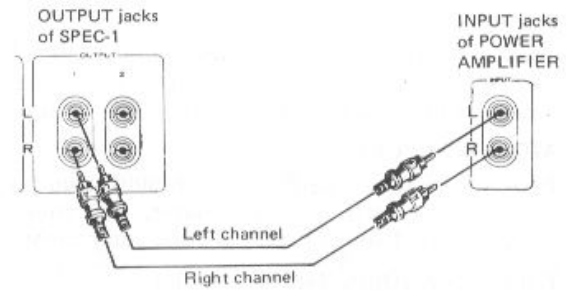
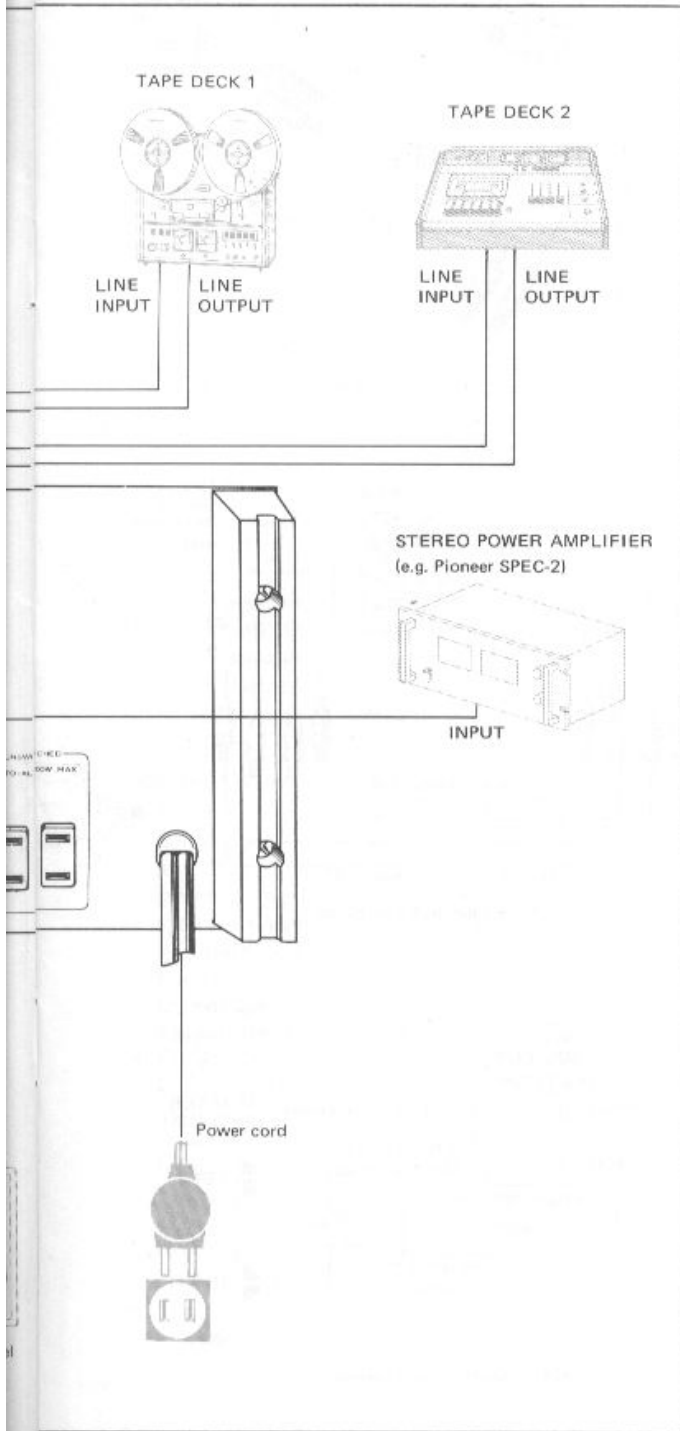

Fig.1 — Power amplifier connection.

AC Convenience Outlets

SWITCHED: AC power is supplied to these outlets when the POWER switch of the SPEC-1 is set to ON (Total power capacity 1350W). By connecting the power cord of a tuner, for example, then leaving the power switch of the tuner set to ON, its power will be supplied together with the operation of the SPEC-1 POWER switch.

UNSWITCHED: AC power is always available and unrelated to the SPEC-1 POWER switch setting (total capacity 100W).

Connecting Cautions

- Use care to connect channels and polarities properly (L to L, R to R, + to +, - to -) when connecting components. All upper jacks are for the left (L) channel and lower jacks for the right (R) channel. Loose connections can cause absence of sound or noise.

TURNTABLE

Connect turntable to the PHONO 1 jacks and its ground lead to the GND terminal.

NOTES:

1. Employ a moving magnet (MM) type cartridge. If a moving coil (MC) type is used, a special matching transformer or head amplifier becomes required.
2. If a second turntable is available, it can be connected to the PHONO 2 jacks.
3. A second tonearm on the same turntable can also be connected to the PHONO 2 jacks.
4. Input level of the PHONO 2 jacks can be adjusted with the PHONO 2 LEVEL control.

TUNER

Connect stereo tuner OUTPUT jacks to the SPEC-1 TUNER jacks. If using more than one tuner, connect additional units to the AUX 1 or 2 jacks.

AUX 1 & 2 JACKS

These are auxiliary input jacks. Employ them for connecting a cartridge tape player, TV sound tuner, a second stereo tuner, or other components.

TAPE DECK (Open Reel or Cassette)

Two sets of recording and two sets of playback jacks are provided on the SPEC-1. Connect as follows.

Recording Connections

Use connecting cords to connect the TAPE 1 REC jacks to the recording input (LINE INPUT) jacks of a tape deck.

Playback Connections

Use connecting cords to connect the TAPE 1 PLAY jacks to the playback output (LINE OUTPUT) jacks of the tape deck.

NOTES:

1. Connect a second tape deck to the TAPE 2 jacks.
2. Employ connecting cords supplied with tape deck.

SPEAKER SYSTEMS

A SPEAKERS selector switch and two sets of stereo speaker system terminals are provided on the SPEC-1, in addition to terminals for connecting the power amplifier. These allow speaker systems to be selected. Connect speaker systems through the SPEC-1 as follows.

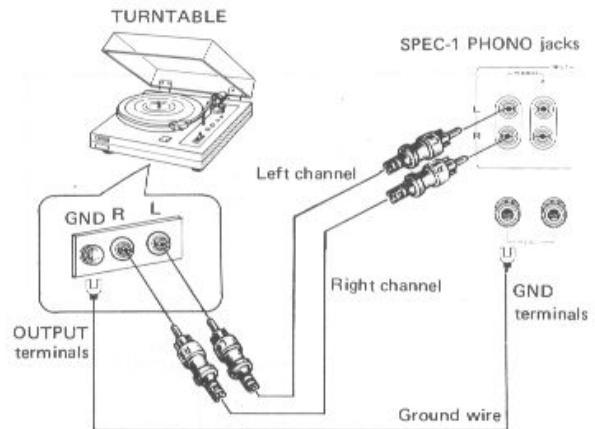

Fig.2 - Turntable connection.

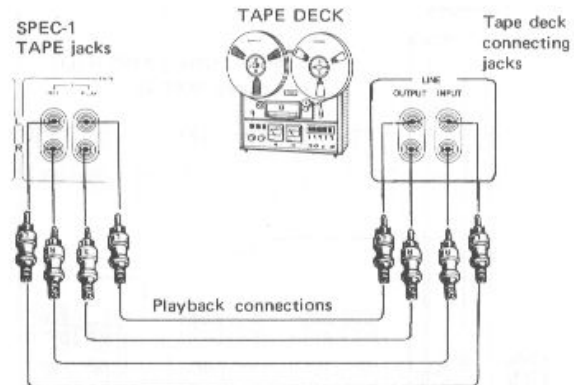

Fig.3 - Tape deck connection.

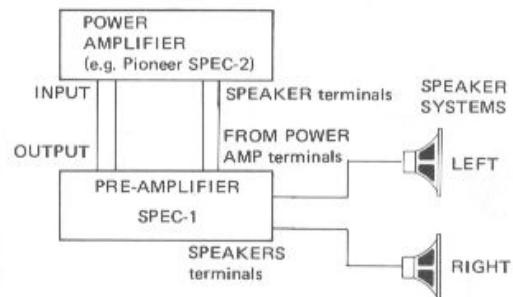

Fig.4 - Speaker systems set-up.

POWER AMPLIFIER OUTPUT CONNECTION

As shown in Fig. 5, use speaker cord to connect the power amplifier speaker output terminals to the FROM POWER AMP terminals of the SPEC-1. Carefully observe channels and polarities of the respective terminals. Connect the same channels (right to right, left to left) and the same polarities (plus to plus, minus to minus) between the two units. See Connecting Cord Installation below.

Connecting Cord Installation

1. Strip about 10mm (3/8in.) of the insulation from the end of the cord.
2. If the conductor is stranded, twist the strands together to prevent fraying.
3. As shown in Fig. 6, while pressing the lever with the fingertips, insert the wire into the hole.
4. Return lever to its original position to secure the cord.

SPEAKER SYSTEMS CONNECTIONS

Two sets of SPEAKERS terminals (A and B) are provided. Use speaker cord to connect the right (R) speaker terminals to the right channel speaker system (at listener's right as viewed from listening position) and the left speaker terminals to the left channel speaker system. Use care to properly connect terminal and speaker system polarities: plus (+) to plus, and minus (-) to minus. See Connecting Cord Installation above.

Speaker Connecting Cautions

- Connect speaker systems which match the nominal output impedance of the employed power amplifier. Damage can be caused if lower impedance speaker systems are used. If two sets of systems (A and B) are to be used simultaneously, their combined impedance must be within the rating of the power amplifier (in most cases, do not use speaker systems with less than 8 ohms impedance in this application).
- Cords used for connecting the power amplifier to the FROM POWER AMP terminals and those used for speaker system connections must possess ample power handling capacity. Use thick, well insulated cord if the power amplifier output is high. If the cord power handling capacity is insufficient, or connections faulty, overheating or shorting can occur.

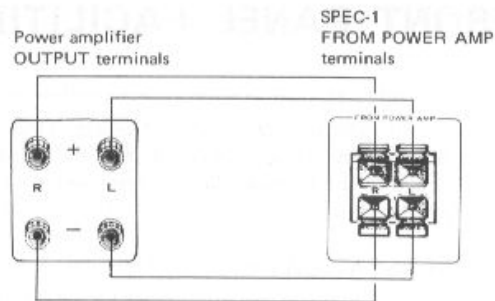

Fig.5 - Connection between Power amplifier output and SPEC-1 FROM POWER AMP terminals.

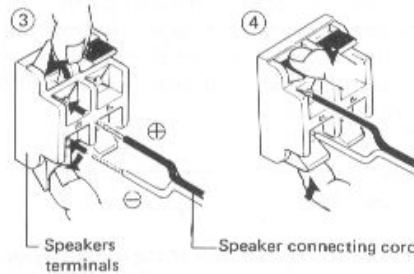
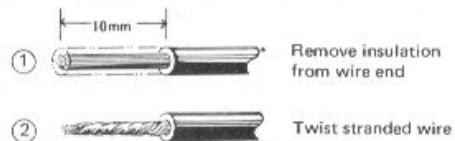

Fig.6 - SPEC-1 FROM POWER AMP and SPEAKERS terminals.

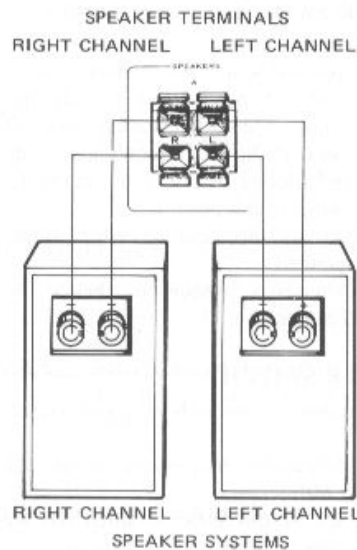

Fig.7 - SPEC-1 SPEAKERS terminals and speaker systems connections.

FRONT PANEL FACILITIES

POWER SWITCH

Set switch to ON to turn on SPEC-1 power. There is a brief delay before sound is obtained from the speakers. This is due to the internal muting circuit and does not signify malfunction.

SPEAKERS SWITCH

If the power amplifier output (SPEAKER OUTPUT or LINE OUTPUT) is connected to the SPEC-1 FROM POWER AMP terminals, and the speaker systems connected to the SPEC-1 SPEAKERS terminals, desired speaker systems can be selected by this switch.

- OFF: Sound not obtained from speakers. Set to this position if the speakers are not connected through the SPEC-1.
- A: Sound obtained from speaker systems connected to the SPEAKERS A terminals.
- B: Sound obtained from speaker systems connected to the SPEAKERS B terminals.
- A + B: Sound obtained simultaneously from both A and B speaker systems.

PHONES JACK

Output jack for stereo headphones.

NOTE:

This PHONES jacks is only available if the output of the power amplifier is connected to the FROM POWER AMP terminals of the SPEC-1.

LOW FILTER SWITCH

Cuts low frequency noise.

- 15Hz: Attenuates ultra-low frequency noise such as produced by warped records by 12dB/octave. Although inaudible, since this noise can contribute to intermodulation distortion and speaker deterioration, normally set the switch to this position.
- OFF: Set to this position when filter is not required.
- 30Hz: Attenuates frequencies below 30Hz by 12dB/octave.

HIGH FILTER SWITCH

Cuts high frequency noise such as record scratch or tape hiss.

- 12kHz: Attenuates frequencies above 12kHz by 12dB/octave.
- OFF: Set to this position when not employing filter.
- 8kHz: Attenuates frequencies above 8kHz by 12dB/octave.

BASS TWIN CONTROLS

Two controls for adjusting low frequency tone.

100Hz: Adjusts frequency band below 100Hz. +7.5dB ~ -7.5dB adjustment can be performed at 100Hz.

50Hz: Provides additional adjustment to 100Hz control for frequency band below 200Hz. +4.5dB ~ -4.5dB adjustment can be performed at 50Hz.

PILOT LAMP

Lights when SPEC-1 POWER switch is set to ON.

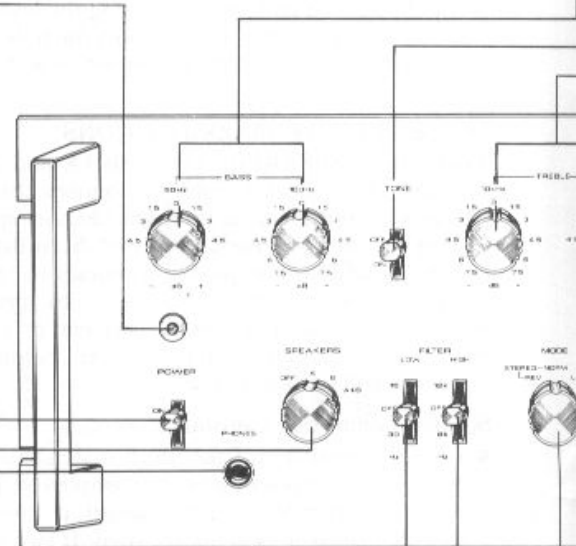

MODE SWITCH

- STEREO REV: Left and right stereo channels are reversed and presented stereophonically.
- STEREO NORM: Set to this position for normal stereo listening.
- MONO L + R: Left and right stereo channels are mixed and presented monophonically.
- MONO L: Left channel of stereo signal is presented monophonically at both left and right OUTPUT jacks.
- MONO R: Right channel of stereo signal is presented monophonically at both left and right OUTPUT jacks.

TONE SWITCH

When set to OFF, BASS and TREBLE twin controls are bypassed and a flat frequency response obtained. Convenient for checking phono cartridge and speaker tone, twin control effectiveness, and listening room acoustics.

TREBLE TWIN CONTROLS

Two controls for adjusting high frequency tone.

10kHz: Adjusts frequency band above 2.5kHz. +7.5dB ~ -7.5dB adjustment can be performed at 10kHz.

20kHz: Provides additional adjustment to 10kHz control for frequency band above 5kHz. +4.5dB ~ -4.5dB adjustment can be performed at 20kHz.

VOLUME CONTROL

Adjusts output level to the OUTPUT jacks, PHONES jack and SPEAKER output terminals. Scale indicates attenuation in dB with maximum output level taken as 0dB. Can be employed in combination with ATTENUATOR switch to provide fine adjustment of additional attenuation steps. See Volume Control and Attenuator Switch on Page 14.

PHONO 2 LEVEL CONTROL

Control operation allows input level of PHONO 2 jacks to be attenuated up to 12dB.

FUNCTION SWITCH

Selects desired program source.

PHONO 2: To play record on turntable connected to PHONO 2 jacks.

PHONO 1: To play record on turntable connected to PHONO 1 jacks.

TUNER: To listen to tuner connected to TUNER jacks.

AUX 1: To play component connected to AUX 1 jacks.

AUX 2: To play component connected to AUX 2 jacks.

MIC MIXING CONTROL

Pull control outward to ON when using microphone. Turn the control to adjust ratio between another program source and the microphone source. See Using Microphone on Page 11.

MIC JACK

Jack for connecting microphone. Set MIC MIXING control to ON when using microphone. Be sure to unplug microphone when not using it.

TAPE MONITOR SWITCH

1: To monitor or play tape on tape deck connected to TAPE 1 (REC and PLAY) jacks.

SOURCE: Set to this position when not playing tape.

2: To monitor or play tape on tape deck connected to TAPE 2 (REC and PLAY) jacks.

TAPE DUPLICATE SWITCH

By employing two tape decks, recorded tape can be duplicated (dubbed) onto new tape. Also set to ON for editing. Normally set this switch to OFF.

BALANCE CONTROL

Control for adjusting volume balance between left (L) and right (R) channels. Clockwise rotation from center increases right channel sound and diminishes the left channel sound. The opposite is obtained with counter-clockwise rotation from center.

ATTENUATOR SWITCH

Provides additional attenuation of output level and speaker output signal to the VOLUME control.

Position	Attenuation
0dB	None
-15dB	15dB
-30dB	30dB

Normally set this switch to where comfortable volume is obtained with the VOLUME control near center of rotation. It is also convenient for temporarily reducing the volume when changing records or tapes, etc.

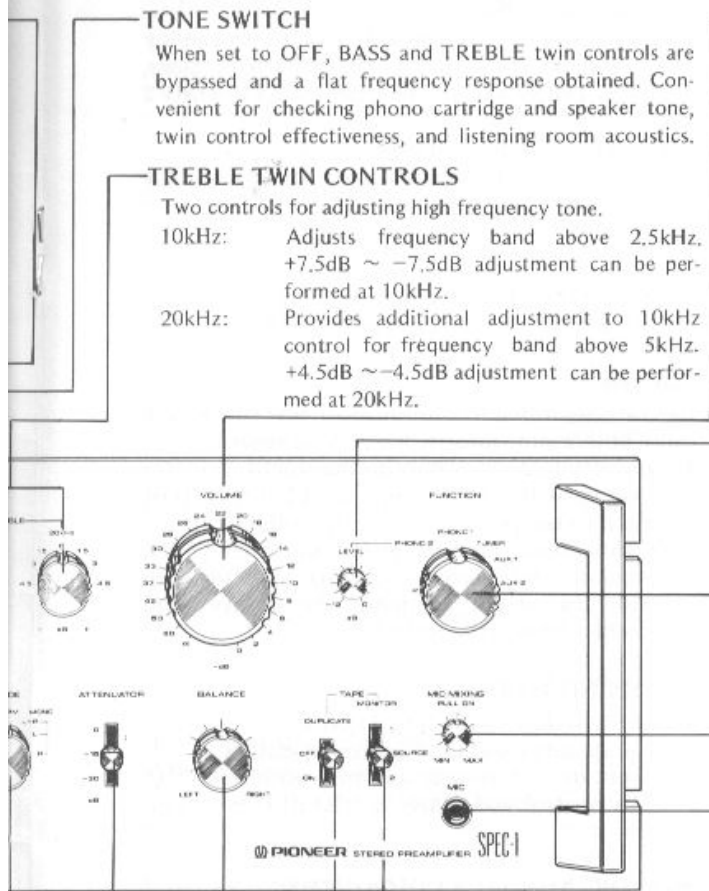

BEFORE OPERATING

POWER AMPLIFIER

1. If the employed power amplifier draws less than 1350W power, it can be plugged into a SWITCHED AC convenience outlet on the rear of the SPEC-1. Higher power amplifiers, which draw more than 1350W should be plugged directly into an AC wall outlet.
2. Set and leave the POWER switch of the power amplifier ON. Power supply will then be coupled with ON-OFF operation of the SPEC-1 POWER switch.

Before Turning on the Power of the SPEC-1, Set the Controls and Switches as follows.

1. VOLUME control to minimum (∞).
2. ATTENUATOR switch to 0dB. If the input level rating of the power amplifier is low, set this switch to -15dB or -30dB.
3. BALANCE control to center position.
4. TONE switch to OFF.
5. TAPE MONITOR switch to SOURCE and TAPE DUPLICATE switch to OFF.
6. LOW and HIGH FILTER switches to OFF.
7. MODE switch to STEREO NORM.
8. BASS and TREBLE twin controls to 0dB.
9. MIC MIXING control to OFF (depressed position).
10. If speaker systems are connected to the SPEC-1, set the SPEAKERS switch according to the employed terminals.

BASIC OPERATION

PLAYING RECORDS

1. Set FUNCTION switch to PHONO 1 to employ a turntable connected to the PHONO 1 jacks, and to PHONO 2 if connected to the PHONO 2 jacks.
2. Operate turntable and play record.
3. Adjust desired volume and tone with the VOLUME control and BASS & TREBLE twin controls.

NOTE:

Input level of the PHONO 2 jacks can be adjusted with the PHONO 2 LEVEL control. See additional description on Page 14.

Cautions

Use care regarding the following points which may cause bothersome noise when playing records.

- Lower tonearm gently onto the record. It is also effective at this time to use the ATTENUATOR switch to temporarily reduce the volume.
- Observe that vibration is not imparted to the turntable while record is playing. Vibration can cause the stylus to jump the grooves and possibly damage the record.

LISTENING TO TUNER

1. Set FUNCTION switch to TUNER.
2. Operate tuner and tune in desired station.
3. Adjust desired volume and tone with the VOLUME control and BASS & TREBLE twin controls.

PLAYING AUX JACK COMPONENTS

Operate component (cartridge tape player, etc.) connected to the AUX 1 or 2 jacks.

1. Set FUNCTION switch to AUX 1 or 2 according to the jacks to which the component is connected.
2. Operate selected component.
3. Adjust desired volume and tone with the VOLUME control and BASS & TREBLE twin controls.

EMPLOYING HEADPHONES

If the power amplifier output (SPEAKER OUTPUT or LINE OUTPUT) is connected to the SPEC-1 FROM POWER AMP terminals, insert the headphones plug in the jack on the SPEC-1 front panel. When sound is not required from the speakers, set the SPEAKERS switch to OFF in order to listen through the headphones only.

USING MICROPHONE

The SPEC-1 can be used to amplify the sound from a microphone, or mix and amplify the microphone sound with another program source (tuner, tape, phono, or auxiliary component). This mixed sound, however, cannot be recorded from the TAPE REC jacks.

Mixing Microphone and Another Source

1. Operate desired program source and adjust volume with the VOLUME control.
2. Pull MIC MIXING control outward and begin microphone operation.
3. Use the MIC MIXING control to adjust mixing ratio between microphone and program sources. Turn the control clockwise to reduce the program source volume and increase the microphone source volume, as shown in Fig. 8.
4. Adjust VOLUME control for desired volume.

Using Microphone Only

1. Pull MIC MIXING control outward to ON position.
 2. Set MIC MIXING control to MAX.
 3. Gradually turn the VOLUME control to adjust amplification volume.
- Do not operate other program sources when employing only the microphone.

Microphone Operating Notes

- Microphone signal is reproduced monophonically from both left and right speaker systems.
- Keep microphone separated from speaker systems to avoid feedback howling.
- Set BASS and TREBLE twin controls to center positions. If set too high, howling becomes more easily produced.

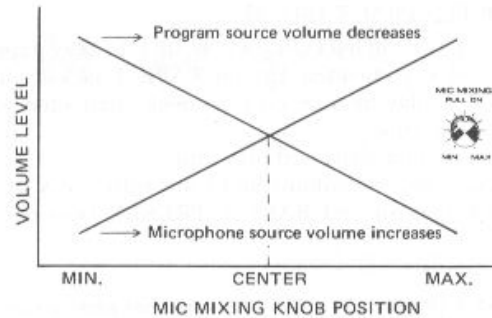

Fig. 8

As indicated in Fig. 8, if microphone and program source input levels are the same, only the program source will be heard when the MIC MIXING control is set to MIN. Clockwise rotation of the control reduces the program source sound and increases the microphone source sound, with a 1 : 1 ratio obtained at center position. When set fully clockwise to MAX, only the microphone source can be heard, without the program source.

USING TAPE DECKS

TAPE PLAYBACK (Fig. 9)

1. Set TAPE MONITOR switch to 1 to play tape on deck connected to the TAPE 1 jacks, and to 2 if playing tape on tape deck connected to TAPE 2 jacks.
2. Operate tape deck and play tape.
3. Adjust desired volume and tone with the VOLUME control and BASS & TREBLE twin controls.

NOTES:

1. Set TAPE switch to SOURCE when not playing tape.
2. FUNCTION switch position is irrelevant when playing tape.

TAPE RECORDING (Fig. 10)

1. Set FUNCTION switch to desired program source (PHONO 1 or 2, TUNER, etc.) for recording.
2. Operate selected program source.
3. Adjust recording levels with tape deck controls and begin recording.

Recording Monitor

If using a 3 head type tape deck, recording conditions can be monitored from the speakers by setting the TAPE MONITOR switch to 1 (or 2). Both recording and playback connections are required in this case.

TAPE DUPLICATION OR EDITING

If two tape decks are available, the desired portions only of a previously recorded FM program, for example, can be re-recorded onto a second tape. A personal tape library can be compiled in this manner. This feature also permits transferring a program from open reel tape to cassette tape.

1. Connect two tape decks as shown in Fig. 11.
 2. Set TAPE DUPLICATE switch to ON.
 3. Play recorded tape on one of the decks (1 or 2) and record with the other deck.
- Perform duplication while monitoring recording conditions. At this time, set TAPE MONITOR switch to 1 (or 2) according to the tape deck being used for recording.

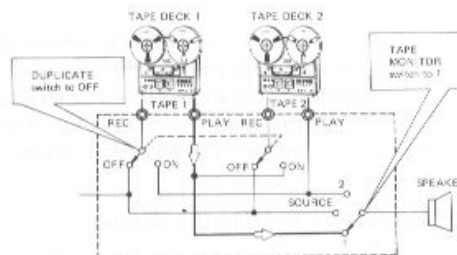

Fig. 9

Tape Play: Playback signal from TAPE 1 (or 2) jacks passes through TAPE MONITOR switch 1 (or 2) and is heard from the speakers.

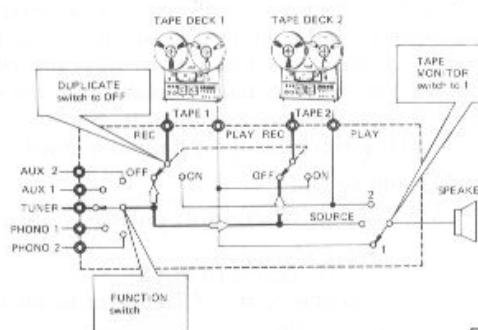

Fig. 10

Tape Recording: Input signal selected by the FUNCTION switch (PHONO, TUNER, etc.) is always present at a fixed level at the TAPE 1 and 2 REC jacks. Recording conditions can be monitored at this time by setting the TAPE MONITOR switch to 1 (or 2), according to the TAPE REC jacks being used for recording.

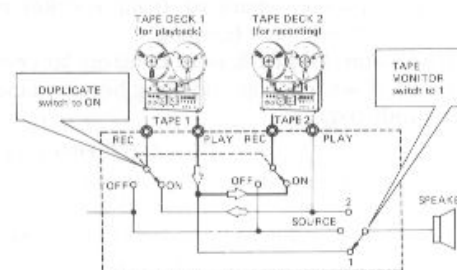

Fig. 11

Duplication: Tape deck 1 playback signal from TAPE 1 PLAY jacks passes through DUAL DUPLICATE switch (when set to ON) and is recorded by tape deck 2. Duplication can also be performed in the opposite direction from tape deck 2 to tape deck 1.

EFFECTIVE OPERATION

BASS AND TREBLE TWIN CONTROLS

A twin tone control system is provided which incorporates main and sub controls, as illustrated in Figs. 12 ~ 15. Tone adjustments can be performed in the same manner as with conventional tone controls. The subcontrols provide the same function as changing the turnover (or roll over) frequency. Approximately 5900 tone combinations can be obtained by using both controls.

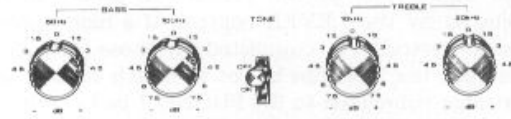

Fig.12 - Tone control knobs and switch.

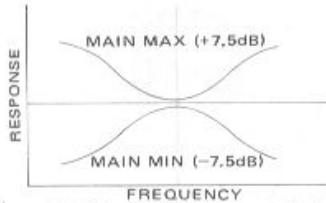

Fig.13 - MAIN Tone control characteristic.

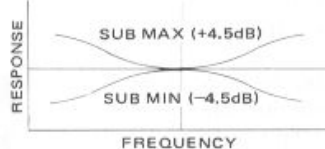

Fig.14 - SUB Tone control characteristic.

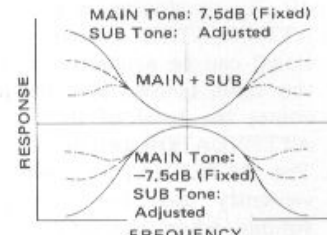

Fig.15 - Both Tone control characteristic.

Typical Applications

- Low frequencies in the 100Hz - 150Hz region, which delicately influence bass impression, can be enhanced by a 0.8dB - 1.0dB margin. While retaining an overall flat impression, slightly more weight can be obtained in the low frequency band. Since the opposite adjustment can also be performed, such effects as standing waves and extended reverberations, which can occur in steel framework buildings and lend an unnatural influence, are often improved. See Fig. 16.
- High frequencies can be adjusted by the TREBLE twin controls to compensate for quavering which often occurs with moving magnet (MM) type phono cartridges. When conventional tone controls are used to enhance high frequencies from records, to cite another example, ultra high frequency peaking can occur from the phono cartridge. This drawback is eliminated by the twin control system, which can enhance 8kHz - 10kHz frequencies slightly, while returning higher frequencies to a flat response. See Fig. 17.
- Careful adjustment of the BASS and TREBLE twin controls can provide the equivalent effect as enhancing the midrange. This is a useful technique for obtaining a close up of a singer's voice or similar applications. See Fig. 18.

Even when the twin controls are set for various response characteristics, a completely flat response can be obtained at any time by setting the TONE switch to OFF. The delicate effects of the tone controls can be confirmed by employing them according to the program source.

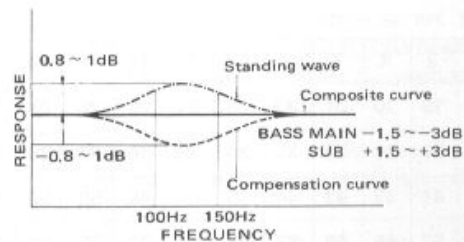

Fig.16 - To improve unnatural low frequencies.

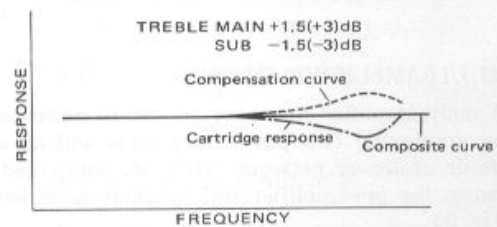

Fig.17 - Compensation for high frequency slackening of cartridge.

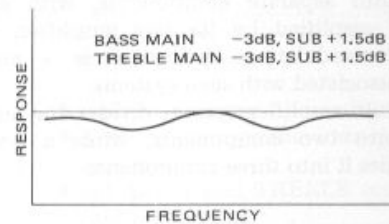

Fig.18 - Relatively enhancing the midrange.

PHONO 2 JACKS

The input level of the PHONO 2 jacks can be adjusted by the LEVEL control. If a high output phono cartridge is connected to these jacks, for example, the level can be set to match that of the cartridge connected to the PHONO 1 jacks. Adjustment range is 2.5mV – 10mV.

VOLUME CONTROL AND ATTENUATOR SWITCH

- The VOLUME control scale is direct reading in dB. By employing it in combination with the ATTENUATOR switch 56 volumes (attenuations) can be accurately obtained, as shown in the table below. The attenuation amount becomes the total of the VOLUME control and ATTENUATOR switch values.
- The ATTENUATOR switch can also be conveniently used for temporarily reducing the volume when changing records or tapes, etc. This eliminates the need for continually re-adjusting the VOLUME control.

Table. 1

0	2	4	6	8	10	12	14	15	16	17
18	19	20	21	22	23	24	25	26	27	28
29	30	31	32	33	34	35	36	37	38	39
40	41	42	43	44	45	46	48	50	52	54
56	57	58	60	63	65	67	72	75	80	90
∞										

In dB

MULTI-AMPLIFIER SYSTEM

A multi-amplifier stereo system can be constructed by employing two power amplifiers and an electronic crossover network. They are connected between the pre-amplifier and speakers as shown in Fig. 21.

This type of system divides the audio frequency spectrum into separate components, with each component amplified by its own amplifier. Improved intermodulation distortion is a major advantage associated with such systems.

A 2-way multi-amplifier system divides the audio spectrum into two components, while a 3-way system divides it into three components.

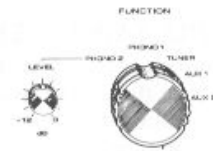

Fig.19 – FUNCTION switch and PHONO 2 LEVEL control knob.

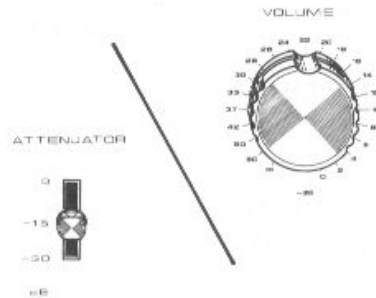

Fig.20 – ATTENUATOR switch and VOLUME control knob.

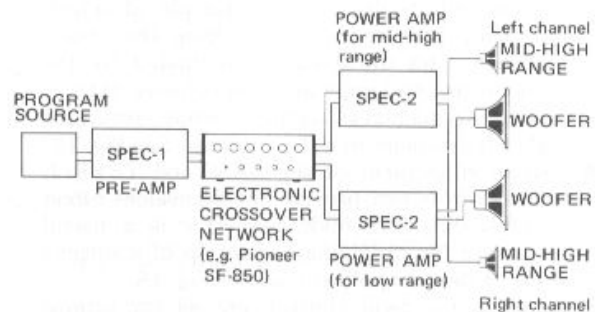

Fig.21 – Multi-amplifier system set-up.

CONDITIONS FREQUENTLY MISTAKEN FOR MALFUNCTION

In event of suspected malfunction, check the unit according to the following table and confirm proper operation of other connected equipment.

If the difficulty cannot be corrected, turn off the power and contact a Pioneer Authorized Service Center.

Symptom	Check Points	Causes and Corrections
No output (sound not obtained)	Observe if pilot lamp is lit	<ul style="list-style-type: none"> ● Plug power cord properly into a live AC outlet. ● Set POWER switch to ON.
	Examine input and output jack connections	<ul style="list-style-type: none"> ● Connect properly. ● If connections are correct, check operation of connected components.
	See that FUNCTION switch is set to desired program source	<ul style="list-style-type: none"> ● Set FUNCTION switch to match program source.
	Observe ATTENUATOR switch and VOLUME control positions	<ul style="list-style-type: none"> ● Test by setting ATTENUATOR switch to 0dB and turning the VOLUME control clockwise.
	Check if microphone is plugged into MIC jack and MIC MIXING control set to ON.	<ul style="list-style-type: none"> ● If MIC MIXING control is set to MAX, source sound will not be heard; conversely, if set to MIN, microphone sound will not be obtained.
No sound from speaker systems or headphones connected to SPEC-1	Check for proper connections between FROM POWER AMP terminals of SPEC-1 and power amplifier speaker output terminals	<ul style="list-style-type: none"> ● Make sure that polarities (+ and -) and channels (left and right) are correctly connected.
	Observe SPEAKER switch position	<ul style="list-style-type: none"> ● Set switch to position corresponding to SPEC-1 SPEAKER terminals to which speaker systems are connected.
Intermittant noise	Examine cords for proper connections (ground lead connection is important for reducing noise)	<ul style="list-style-type: none"> ● Insert plugs firmly into jacks.
	Is connected component defective?	<ul style="list-style-type: none"> ● Correct cause of difficulty.
Microphone cannot be used	Ensure that microphone is properly plugged in	<ul style="list-style-type: none"> ● Examine microphone connection.
	Check that MIC MIXING control is in ON position	<ul style="list-style-type: none"> ● Pull control outward to ON, then turn it clockwise.
	Howling produced	<ul style="list-style-type: none"> ● Reduce volume. ● Keep microphone away from speakers. ● Set BASS and TREBLE controls to center positions.

IMPORTANT—LINE VOLTAGE

The SPEC-1 is provided with a line voltage selector on the left hand side panel (see Fig. A). This is normally pre-set to 220V, so before using for the first time, or if the unit is to be used in a different area, it is important to check the compatibility of the selector setting and fuse rating.

CHANGING THE LINE VOLTAGE SETTING

1. Disconnect the A.C. mains cord.
2. Use a Phillips screwdriver to remove the selector cover (Fig. A).
3. Pull out the selector plug.
4. Replace the plug so that the arrow points to the appropriate line voltage (Fig. B).

CHANGING THE FUSE

Whenever the line voltage is changed the fuse must also be changed in accordance with the table in Fig. C.

1. Disconnect the mains cord.
2. Use a Phillips screwdriver to remove the 12 screws securing the bottom plate.
3. Five fuses are located at the rear center of the SPEC-1.
4. Remove and replace only the rearmost fuse (see Fig. D).

3 Line Voltage model
~ AC 120/220/240Volts
50/60Hz

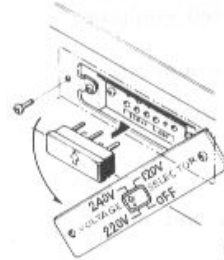
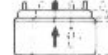
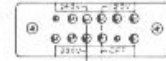
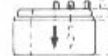

Fig. A

LINE VOLTAGE SELECTOR
~AC 120V, 220V, 240V
50Hz/60Hz



240V 120V



220V OFF

Fig. B

Local Line Voltage	Fuse
120V	0.5A
220V	0.3A
240V	0.3A

Fig. C

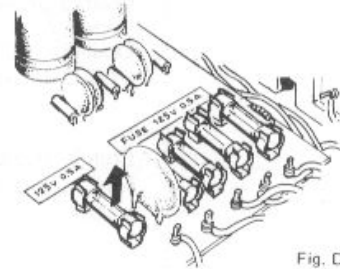

Fig. D

PIONEER ELECTRONIC CORPORATION

4-1, Meguro 1-Chome, Meguro-ku, Tokyo 153, Japan

U.S. PIONEER ELECTRONICS CORPORATION

85 Oxford Drive, Moonachie, New Jersey 07074, U.S.A.

PIONEER ELECTRONIC (EUROPE) N.V.

Luithagen-Haven 9, 2030 Antwerp, Belgium

PIONEER ELECTRONICS AUSTRALIA PTY. LTD.

17B-184 Boundary Road, Braeside, Victoria 3195, Australia