

<R42-232-0>

Service Manual

AM/FM STEREO RECEIVER

SX-828/ KUW, FVZW, FW

NOTE

MODEL SX-828 COMES IN THREE VERSIONS DISTINGUISHED AS FOLLOWS:

Round label on rear panel	Voltage	Type
KUW	120V only	UL approved (U.S.A.)
FVZW	5-position selector	FTZ approved (West Germany)
FW	5-position selector	General export model

(72A02M8ID)

PIONEER[®]

AL BRIGHT

CONTENTS

1. SPECIFICATIONS	1
2. FRONT PANEL FACILITIES	3
3. CONNECTION DIAGRAM	5
4. BLOCK DIAGRAM	7
5. DISASSEMBLY	9
6. PARTS AND PCB LOCATION	
• TOP VIEW	10
• BOTTOM VIEW	10
7. DIAL CORD STRINGING	11
8. ALIGNMENT PROCEDURE	
8.1 REQUIRED INSTRUMENT	12
8.2 FM IF ALIGNMENT	12
8.3 FM TRACKING ALIGNMENT	13
8.4 FM MPX DECODER ALIGNMENT	13
8.5 MUTING THRESHOLD LEVEL ALIGNMENT	13
8.6 AM IF ALIGNMENT	14
8.7 AM TRACKING ALIGNMENT	14
9. SCHEMATIC DIAGRAMS, PCB PATTERNS AND PARTS LIST	
9.1 UNIT CONNECTION DIAGRAM AND MISCELLANEOUS PARTS	15
9.2 FM FRONT END (W11-043) (AWB-005)	26
9.3 TUNER UNIT (AWE-016)	27
9.4 MPX FILTER UNIT (AWX-009)	34
9.5 HEAD AMP UNIT (W21-002)	35
9.6 AF UNIT (AWK-012)	37
9.7 MAIN AMP UNIT (AWH-010)	42
9.8 POWER SUPPLY UNIT (AWR-010)	46
9.9 PROTECTION UNIT (W2B-008)	48
9.10 SWITCH UNIT (AWS-017)	50
10. PACKING METHOD AND PART NUMBERS	51

1. SPECIFICATIONS

SEMICONDUCTORS

FETs	6
ICs	4
Transistors	57
Diodes	37

POWER AMPLIFIER SECTION

Music Power Output (IHF)	270W (4Ω), 180W (8Ω)
Continuous Power Output (1kHz: each channel driven)	95W/95W (4Ω) 70W/70W (8Ω)
Continuous Power Output (1kHz: both channels driven)	75W + 75W (4Ω) 60W + 60W (8Ω)
Power Output in the Range of 20Hz to 20kHz (both channels driven)	54W + 54W (8Ω, Harmonic distortion less than 0.5%)
Harmonic Distortion	Less than 0.5% (Continuous power output) Less than 0.03% (8Ω, 35W/35W power output)
Intermodulation Distortion	Less than 0.5% (Continuous power output) Less than 0.03% (8Ω, 35W/35W power output)
Power Bandwidth (IHF)	10Hz to 60kHz (8Ω, Harmonic distortion Less than 0.5%)
Frequency Response	5Hz to 80kHz, ±1dB
Input Sensitivity/Impedance (1kHz, Continuous power output)	500mV/50kΩ
Speakers	4 to 16Ω
Damping Factor	40 (8Ω, 1kHz)

PREAMPLIFIER SECTION

Output Voltage	500mV (Rated output), 4V (Max.)
Harmonic Distortion	Less than 0.1%
Frequency Response	10Hz to 40kHz, ±1dB
Input Sensitivity/Impedance (1kHz, for rated output)	PHONO 1 MAG 2.7mV/50kΩ PHONO 2 MM 2.7mV/50kΩ MC 115μV/30Ω (with PHONO INPUT transformer "PP-402")
	MIC 2.6mV/50kΩ
	AUX 200mV/100kΩ
	TAPE MONITOR 1, 2 200mV/100kΩ
Recording Output	TAPE REC 1, 2 (Pin jack) 200mV TAPE REC (DIN connector) 35mV
BASS Control	-10dB, +10dB/100Hz
TREBLE Control	-10dB, +10dB/10kHz
LOW Filter	-3dB/60Hz (12dB/oct.)
HIGH Filter	-3dB/6kHz (12dB/oct.)
Equalization Curve	PHONO: RIAA S.T.D.
Loudness Contour	+10dB/100Hz, +6dB/10kHz with Volume Control set at -40dB position.
Muting	-20dB
Hum and Noise	PHONO More than 85dB
(Short circuit, IHF network)	AUX More than 95dB

FM TUNER SECTION

Frequency Range	88MHz to 108MHz 87.5MHz to 108MHz (FTZ approved)
Usable Sensitivity (IHF)	1.7 μ V
Capture Ratio (IHF)	1.5dB
Selectivity (IHF)	More than 75dB
Image Rejection	More than 95dB (98MHz)
IF Rejection	More than 100dB (90MHz)
Spurious Rejection	More than 100dB (98MHz)
AM Suppression	50dB
Signal-to-Noise Ratio	70dB
Harmonic Distortion	Mono: Less than 0.2% (100% Mod.) Stereo: Less than 0.4% (100% Mod.)
Tuning Indicator	Signal strength type and Center tuning type
Muting	Switchable to ON-OFF
Stereo Separation	More than 40dB (1kHz)
Sub Carrier Suppression	More than 50dB
De-emphasis switch	50 μ sec., 75 μ sec. (FW model only)
Antenna Input	Impedance 300 Ω balanced and 75 Ω unbalanced

AM TUNER SECTION

Frequency Range	525kHz to 1,605kHz
Usable Sensitivity (IHF)	10 μ V
Selectivity (IHF)	More than 35dB
Image Rejection	More than 85dB (1,000kHz)
IF Rejection	More than 80dB
Signal-to-Noise Ratio	More than 50dB
Antenna	Built-in ferrite loopstick antenna

MISCELLANEOUS

Power Requirements	120V 60Hz or 110V, 120V, 130V, 220V and 240V (Switchable) 50-60Hz
Power Consumption	370W (Max.)
AC Outlets	Switched 1, Unswitched 2
Dimensions (overall)	19 1/8 in./485 mm (width) 5-15/16 in./150 mm (height) 14 3/4 in./375 mm (depth)
Weight Without package	32 lb 10oz/14.8 kg
With package	39 lb 3oz/17.8 kg
Furnished Parts	FM T-type Antenna 1 Fuse 1 5A 1 3A (5 line voltage model) 2 Pin plug 2 Speaker plug 6 Hexagonal wrench 1 Polishing cloth 1 Operating instructions 1

NOTE: Specifications and the design subject to possible modification without notice due to improvements.

2. FRONT PANEL FACILITIES

SPEAKERS SWITCH

A combination of the power ON/OFF switch and the speaker system selector switch.

POWER OFF: The equipment is off.

A: The speaker system plugged into the A speaker sockets is in operation.

SPKR OFF: All speaker systems off. Useful for listening through headphones.

B: The speaker system plugged into the B speaker sockets is in operation.

C: The speaker system plugged into the C speaker sockets is in operation.

A+B: Both speaker systems A and B are in operation.

A+C: Both speaker systems A and C are in operation.

PHONES JACKS (1, 2)

Use these to plug in stereo headphones.

A full selection of high-performance headphones is available from Pioneer.

BASS & TREBLE CONTROL

Used for adjusting bass and treble.

Clockwise (Counterclockwise) rotation of these controls from the FLAT position will boost (diminish) tone. Also, only the left (right) channel can be adjusted by turning the front (rear) part of the knob while holding the other part in place.

Adjustment of both channels or only the left channel is made by click-stops. For normal listening, set to the FLAT position.

FILTER SWITCHES

LOW: Setting this switch to ON will eliminate low noise such as record rumble, hum, etc. Leave it at OFF unless the filter is required.

HIGH: Setting this switch to ON will eliminate high noise such as record scratch, tape hiss, static noise from fluorescent lamps, etc. Leave it at OFF unless the filter is required.

BALANCE CONTROL

Adjust the stereo balance. When the volume of the right channel speaker is smaller, turn the knob clockwise toward RIGHT; when left channel volume is smaller, turn the knob counterclockwise toward LEFT. For normal listening, set it to the NORM position.

VOLUME CONTROL

The volume increases when this knob is turned clockwise.

SIGNAL METER

This meter indicates the optimum tuning point for AM and FM stations. Maximum deflection to the right indicates that the station has been properly tuned in.

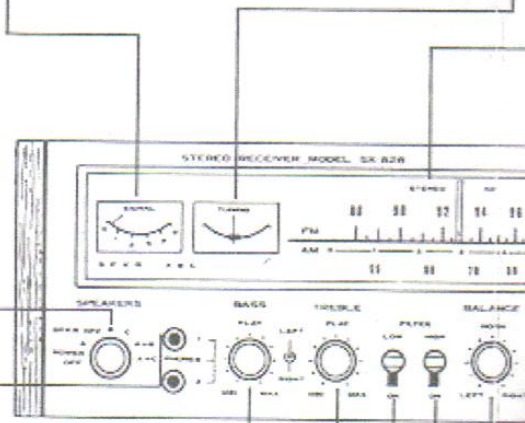

LOUDNESS SWITCH

When listening at low volume level, set this switch to ON. This emphasizes the extreme ends of the sound spectrum, giving a more natural sound contour.

AUDIO MUTING SWITCH

In position -20dB, the volume will be attenuated by 20dB.

For restoring the volume to its former level, set the switch to the OFF position.

FM TUNING METER

When tuning in an FM station, use this meter to make the tuning perfect. After the desired station has been properly tuned in with the SIGNAL METER, adjust the TUNING KNOB so that the needle comes to the center.

FM STEREO INDICATOR

This lamp lights when an FM stereo broadcast is being received.

TUNING KNOB

Used to tune in the desired station.

NOTE: If the setscrews holding the TUNING KNOB should ever become loose, they can be tightened with the supplied L-shaped hexagonal wrench.

DIMMER SWITCH

The brightness of the front panel illumination is controllable by this switch. The front panel becomes dimmer when the switch is pushed in.

FM MUTING SWITCH

This switch is used to suppress noise between FM stations when tuning. When receiving weak stations, this switch should be kept OFF because it would suppress the desired station signal at the same time. Note that this switch is OFF when it is pushed in, and ON when released.

MIC JACKS

Connect the microphone plugs to these jacks. Only high-impedance, dynamic microphones with standard plugs (6.46) should be used. A selection of high-performance dynamic microphone is available from Pioneer.

TAPE MONITOR SWITCHES (1 and 2)

These switches are set to ON for monitoring of a recording in progress or playback of recorded tapes with tape decks.

- 1: This switch is set to ON for using a tape deck plugged into the TAPE 1 MON and TAPE 1 REC jacks or the TAPE 1 REC/P.B. connector.
- 2: This switch is set to ON for using a tape deck plugged into the TAPE 2 MON and TAPE 2 REC jacks.

NOTE: For phonograph records or broadcasts, leave these switches in OFF position. If either of these switches is set to ON, no sound will be heard.

MODE SWITCH

This selects the mode of reproducing sound.

STEREO REV: Stereo, with the input signals of the left and right channels reversed.

STEREO NORM: Normal stereo.
MONO L: Playing the input signals of only the left channel through the left and right speakers.

MONO R: Playing the input signals of only the right channel through the left and right speakers.

MONO L+R: Monophonic reproduction, mixing the input signals of the left and right channels.

SELECTOR SWITCH

Choose the program source.

- AM:** AM reception.
FM MONO: FM monophonic reception only.
FM AUTO: FM reception with automatic switching for either stereo or monophonic programs.
PHONO 1: For playing records on a turntable plugged into the PHONO 1 jacks.
PHONO 2: Same as above, for PHONO 2 jacks.
MIC: Microphone sound can be reproduced.
AUX: For playing signals fed to the AUX jacks.

NOTE: If the front panel inscriptions of your unit become dirty, clean them with volatile fluid (chemical thinner, pure alcohol, etc.). In this case, the letters on the front panel may be blotted. Wipe out them with a soft dry cloth, however they will still remain unerased.

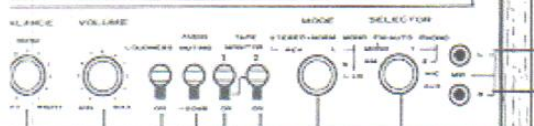
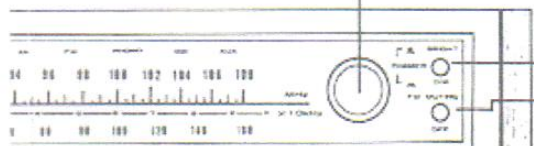

3. CONNECTION DIAGRAM

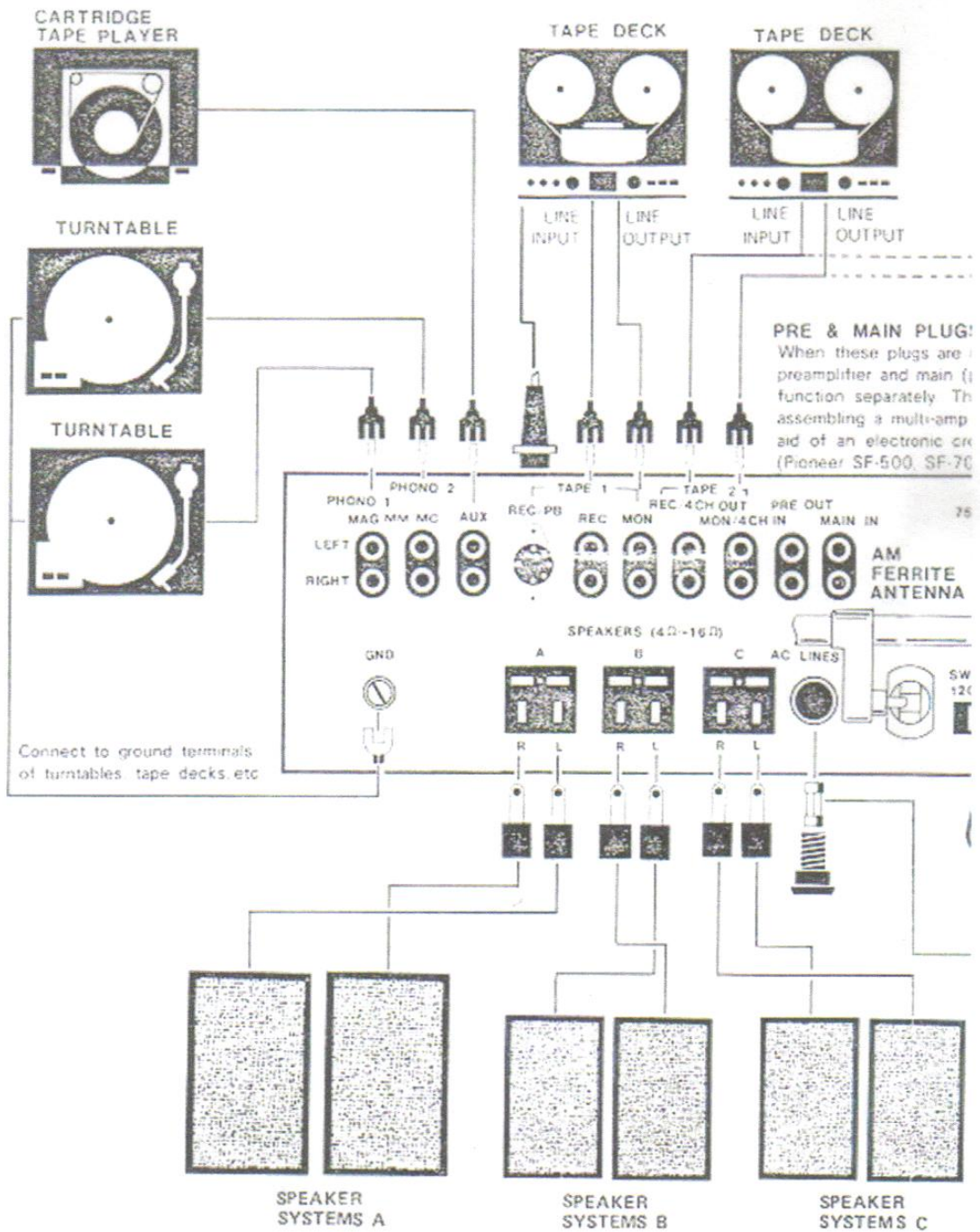

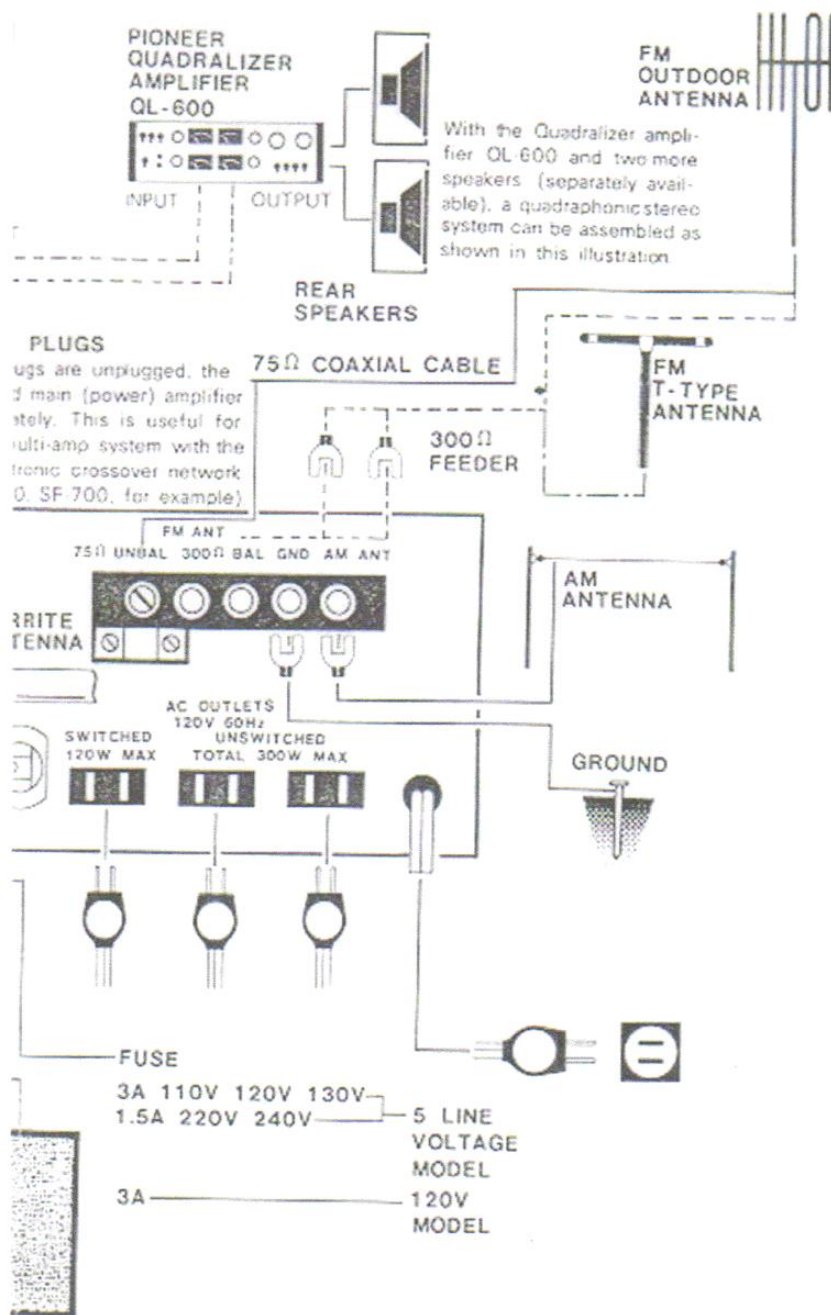

C

4. BLOCK DIAGRAM

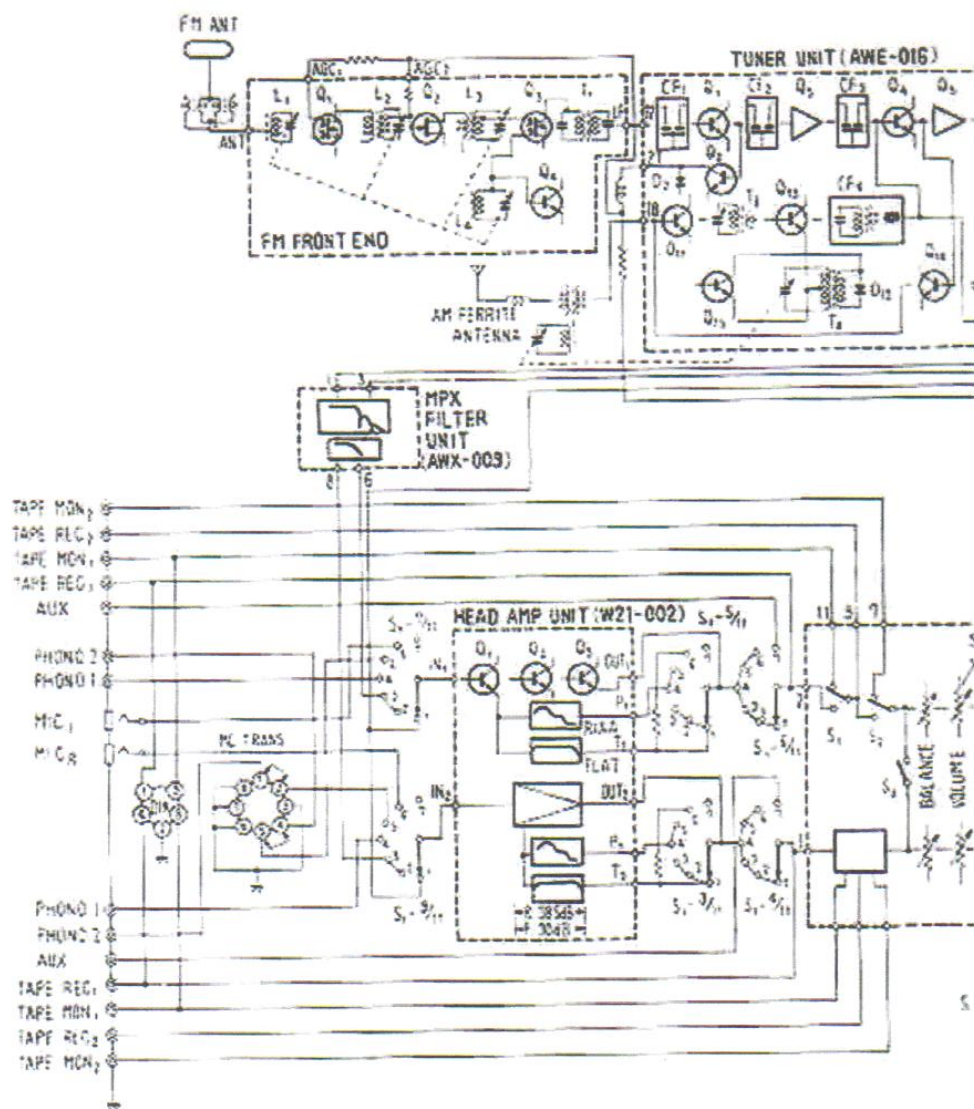

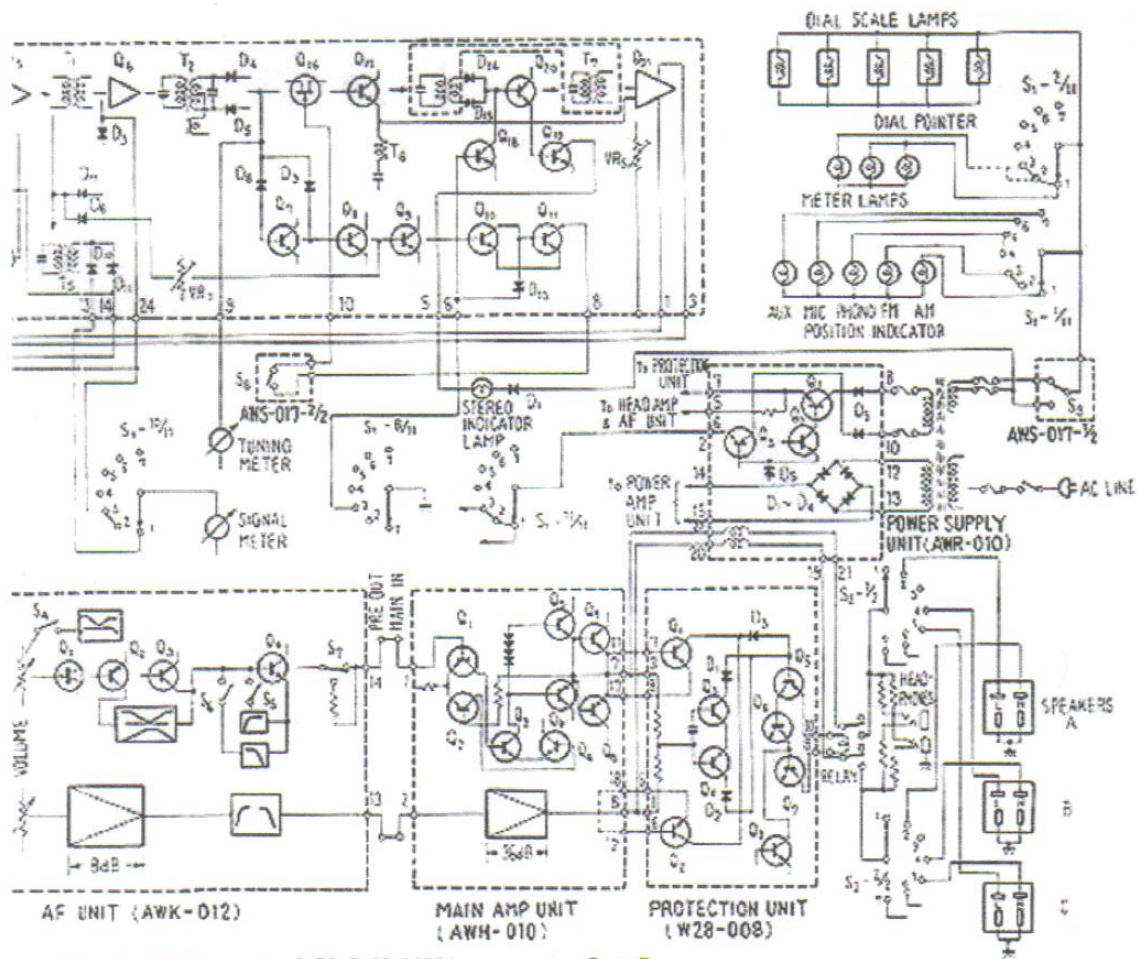

- S₁ INPUT SELECTOR
- 1 .AM
 - 2 .M
 - 3 .M AUTO
 - 4 .MONO 1
 - 5 .MONO 2
 - 6 .TIC
 - 7 .AUX

- S₂ OUTPUT SELECTOR
- 1 POWER OFF
 - 2 SPEAKER A
 - 3 SPEAKER OFF
 - 4 SPEAKER B
 - 5 SPEAKER C
 - 6 SPEAKER A+B
 - 7 SPEAKER A+C

- IN AF UNIT
- S₁ TAPE MONITOR 1
 - S₂ TAPE MONITOR 2
 - S₃ MODE
 - S₄ LOUDNESS
 - S₅ LOW FILTER
 - S₆ HIGH FILTER
 - S₇ MONO MUTING

5. DISASSEMBLY

- Numbers indicate order of disassembly.

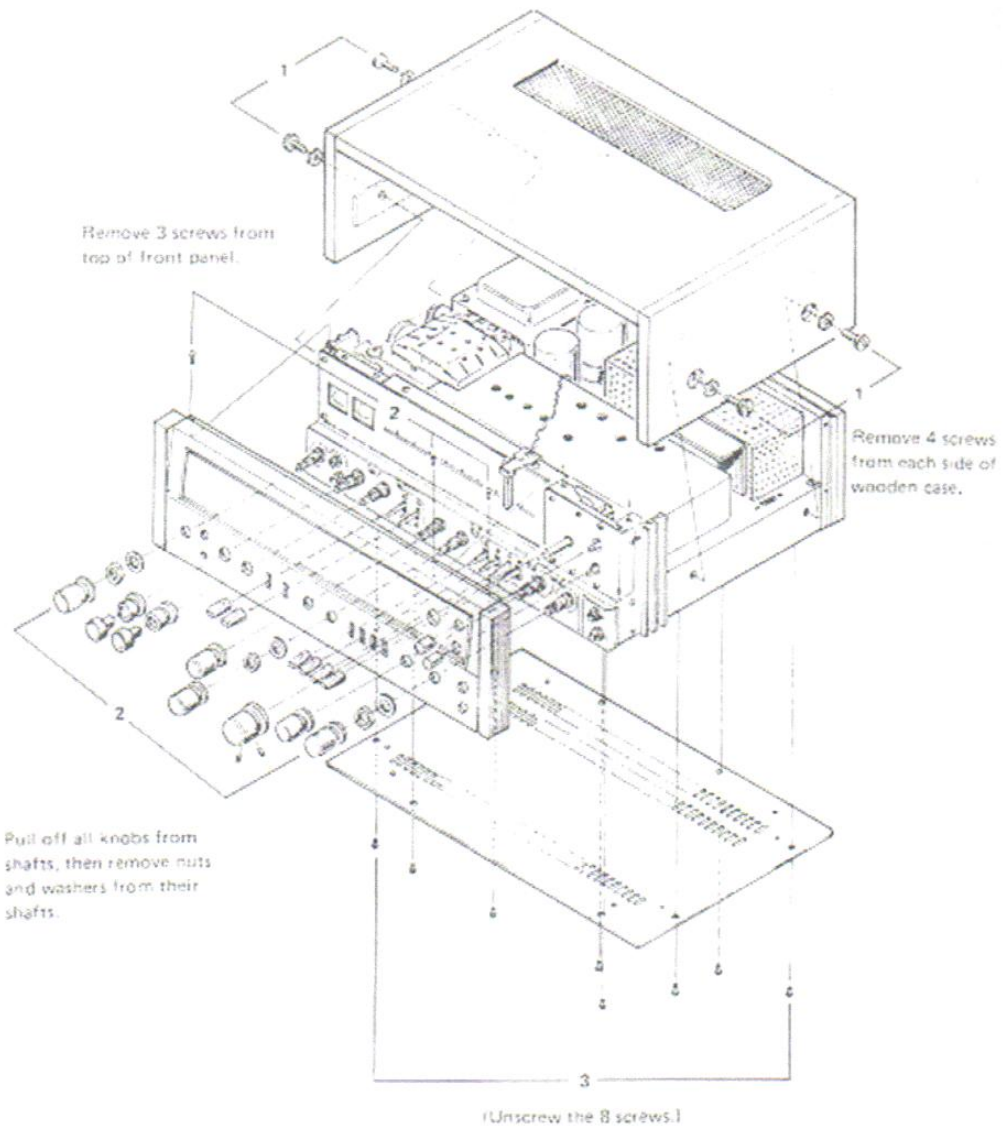

NOTE: RE-ASSEMBLY can be made in reverse order of the above DISASSEMBLY procedure.

6. PARTS AND PCB LOCATION

• TOP VIEW

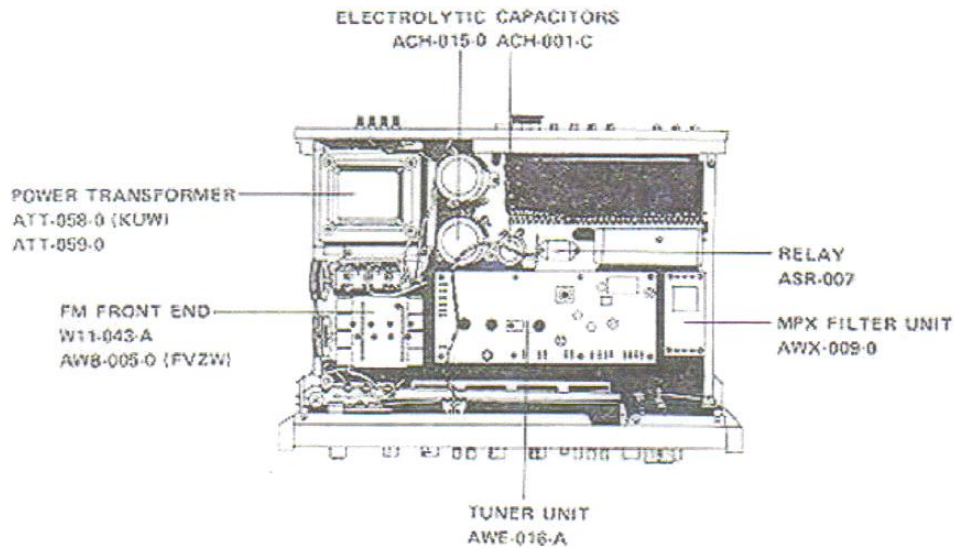

• BOTTOM VIEW

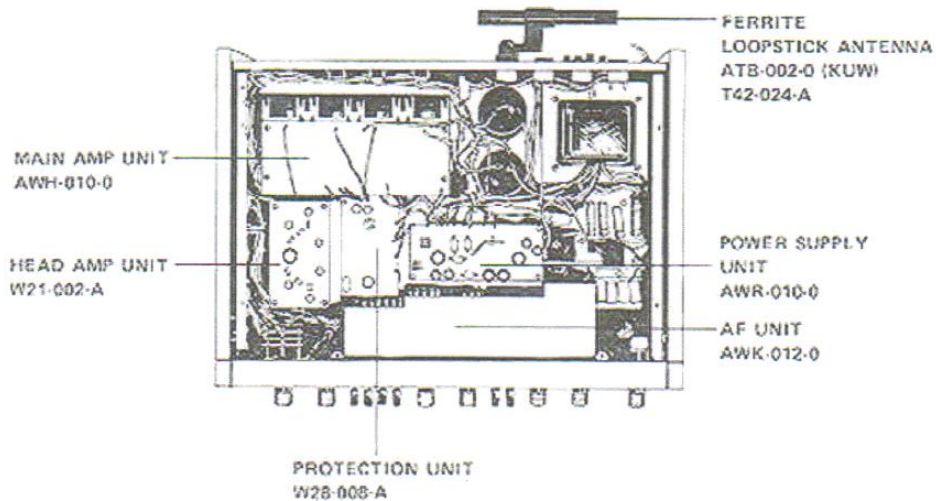

7. DIAL CORD STRINGING

1. Set the both AM and FM tuning capacitors to maximum capacitance.
2. Tie one end of the string to the spring on the AM tuning pulley.
3. Wind the string 1/4 turn around the AM tuning pulley, then wind it 2 turns around the FM tuning pulley.
4. Hook the string to the spring on the FM tuning pulley.
5. Lead the string around the small pulleys A and B.
6. Wind the string 2 turns around the tuning shaft.
7. Lead the string around the small pulleys C and D, then fasten it to the dial pointer.
8. Lead the string around the small pulley E, and wind it 2 turns around the AM tuning pulley.
9. Finally, tie the end of the string to remaining side of the spring on the AM tuning pulley.
10. Tune receiver to low end. Fasten dial pointer to the string so that it indicates low end on dial scale.

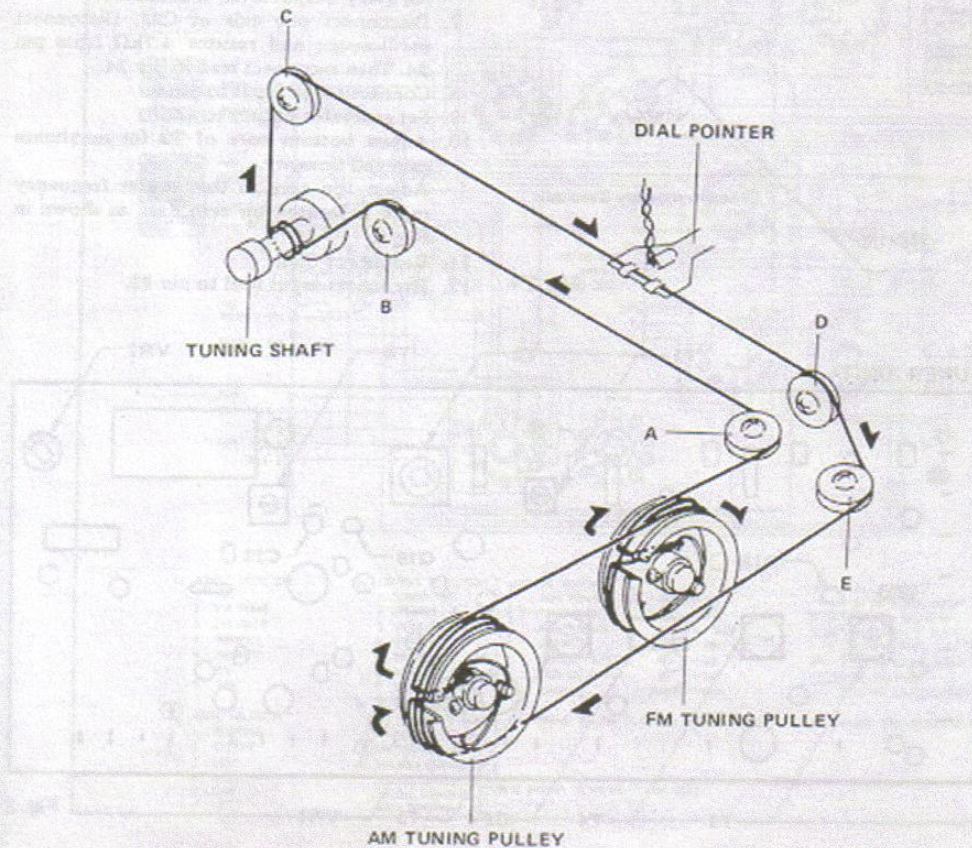

8. ALIGNMENT PROCEDURE

The following alignments are required only in very rare cases and should never be attempted without the proper test equipment. Also, only non-metallic tools must be used.

8.1 REQUIRED INSTRUMENT

- Sweep generator: Center marker frequencies 10.7MHz, 455kHz
- Oscilloscope: Flat to 250kHz minimum
- AC VTVM
- AM/FM signal generator
- FM multiplex signal generator, preferably with RF output

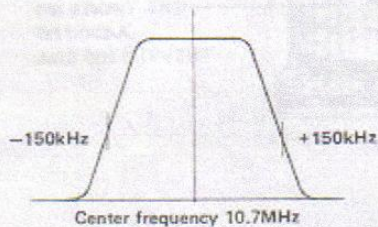

Fig. 1

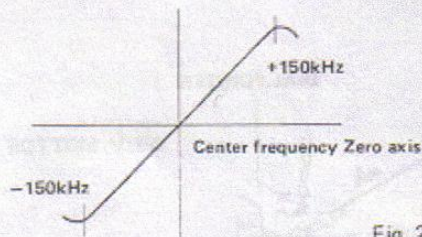

Fig. 2

8.2 FM IF ALIGNMENT

1. Confirm +B voltage and current for 12V \pm 1V which should be 53mA to 65mA at pin 4.
2. Disconnect leads from pin 22 (input) and 24 (MET), then connect resistor 4.7k Ω as shunted to pin 24 of tuner unit.
3. Connect 10.7MHz sweep generator to pins 22 (hot) and 23 (ground) of tuner unit. Set controls as follows:
Center frequency: 10.7MHz
Output: 80dB (10mV)
4. Connect vertical scope input to 24.
5. Align core of T1 for maximum gain and symmetry to obtain scope pattern as in Fig. 1.
6. Vary the generator output gradually from 45dB to 100dB, repeat step 5 realignment for every output level, if necessary.
7. Disconnect one side of C23. Disconnect oscilloscope and resistor 4.7k Ω from pin 24. Then reconnect lead to pin 24.
8. Connect scope input to pin 9.
9. Set generator output to 45dB.
10. Adjust bottom core of T2 for maximum gain and linearity.
Adjust top core so that center frequency mark is located on zero axis, as shown in Fig. 2.
11. Reconnect C23.
12. Reconnect input lead to pin 22.

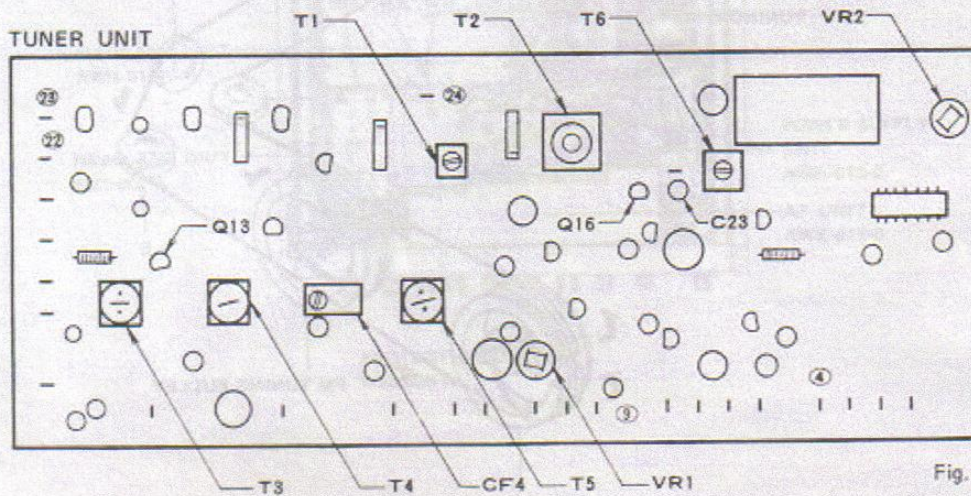

Fig. 3

8.3 FM TRACKING ALIGNMENT

1. Confirm $\pm B$ current (drain 11mA \pm 1mA).
2. Connect FM signal generator output to 300 Ω antenna inputs.
3. Connect AC VTVM to TAPE REC jack on rear panel.
4. Adjust generator for 400Hz, 100% modulation.
5. Set SELECTOR switch on front panel to FM MONO.
6. Adjust generator frequency and tuning dial to 90MHz.
During the following adjustments, keep the generator output as low as possible.
7. Adjust L4 core first, then adjust cores of L1, L2, L3 for maximum reading on VTVM and so that tuning meter indicates center position.
8. Set generator frequency and tuning dial to 106MHz.
9. Adjust trimmer capacitor CT4 first, then adjust CT1, CT2, CT3 for maximum reading on VTVM.
10. Repeat these alignments several times until satisfactory reading is obtained.
11. Finally, adjust T1 core for maximum reading on VTVM.

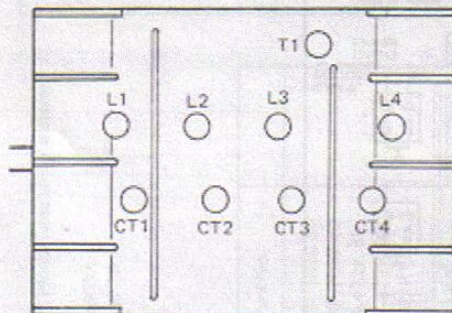

Fig. 4

8.4 FM MPX DECODER ALIGNMENT

1. Set SELECTOR switch on front panel to FM AUTO.
2. Connect RF output of FM multiplex signal generator to 300 Ω antenna inputs.
3. Adjust MPX generator as follows:

Signal Mode	Deviation
L+R	40.5kHz
19kHz (pilot)	7.5kHz
4. Connect AC VTVM to TAPE REC jack on rear panel.
5. Set generator signal mode to L-R (sub) and its output level to 100dB, adjust core of T6 (located on tuner unit) to obtain maximum reading on VTVM.
6. Set generator signal mode to L. Adjust VR2 (located on tuner unit) for minimum crosstalk on R channel TAPE REC output.
7. Set generator signal mode to R. Repeat above adjustment for minimum crosstalk on L channel.

8.5 MUTING THRESHOLD LEVEL ALIGNMENT

1. Set SELECTOR switch to FM MONO.
2. Turn MUTING switch to ON.
3. Connect FM signal generator to 300 Ω antenna inputs.
4. Connect AC VTVM to TAPE REC output jack.
5. Set output level of generator to 25dB (20 μ V), with \pm 22.5kHz deviation, and 400Hz or 1kHz modulation.
6. Tune receiver accurately to generator frequency.
7. Adjust VR1 on tuner unit exactly on the borderline between muting and non-muting.

8.6 AM IF ALIGNMENT

1. Set SELECTOR switch on front panel to AM.
2. Connect 455kHz sweep generator to pin 15. Adjust generator output level to 45dB.
3. Connect vertical oscilloscope input to either L or R of TAPE REC jack.
4. Set tuning dial to high end position.
5. Adjust cores of CF4 and T5 for maximum gain and symmetrical pattern on oscilloscope.

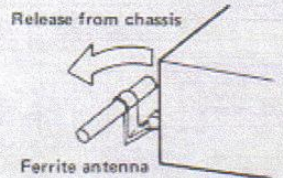
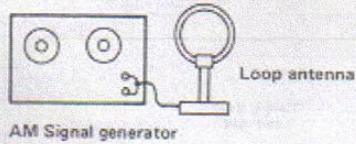

Fig. 5

8.7 AM TRACKING ALIGNMENT

1. Set SELECTOR switch to AM position.
2. Set signal generator to AM function, 30% modulation with 400Hz. Connect loop antenna to generator RF output and place near receiver's ferrite loopstick antenna. See Fig. 5.
3. Connect VTVM to TAPE REC jack.
4. Keep generator as low as possible for minimum VTVM reading.
5. Tune generator and receiver to 600kHz. Adjust core of T4 on tuner unit for maximum VTVM reading, then adjust core of T3 and ferrite antenna.
6. Re-tune generator and receiver to 1,400kHz.
7. Adjust trimmers of variable capacitor indicated in Fig. 6 to obtain maximum VTVM reading.

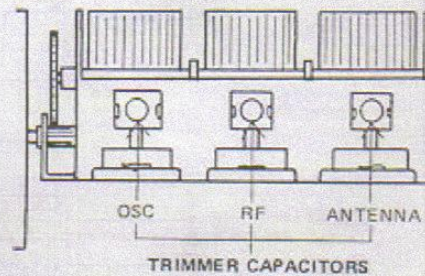
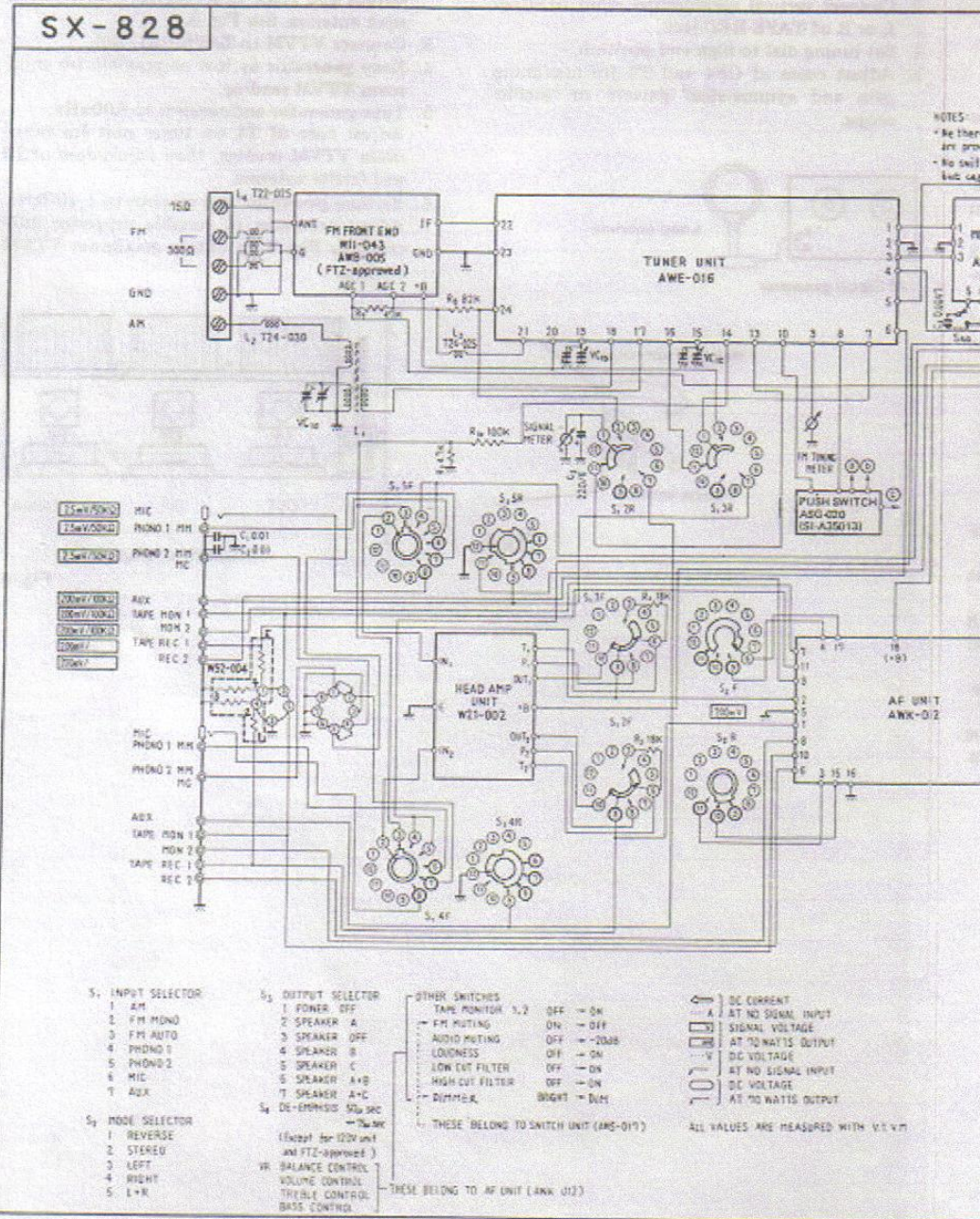

Fig. 6

9. SCHEMATIC DIAGRAMS, PCB PATTERNS AND PARTS

9.1 UNIT CONNECTION DIAGRAM AND MISCELLANEOUS PARTS

SX-828



MISCELLANEOUS PARTS

This parts list is for the KUW model, the FVZW or FW model uses some different parts as following pages:
 for FVZW model page 20,
 for FW model page 23.

CAPACITORS

IN μ F UNLESS OTHERWISE NOTED. p: μ MF.

Symbol	Description	Part No.
C1	Ceramic 0.01 50V	CKDYF 103Z 50
C2	Ceramic 0.01 50V	CKDYF 103Z 50
C3	Mylar 0.0047 50V	CGMA 472K 50
C4	Mylar 0.0047 50V	CGMA 472K 50
C5	Electrolytic 220 6V	CEA 221P 6
C6	Electrolytic 8000 50V	ACH-015-0
C7	Electrolytic 8000 50V	ACH-015-0
C8	Electrolytic 1000 63V	ACH-001-C
C9	Electrolytic 470 16V	CEB 471P 16
C10	Oil paper 0.01 800V	ACE-001-A
C11	Ceramic 0.01 DC 1.4kV	C43-003-0
C12	Mylar 0.022 50V	COMA 223K 50
VC1	AM tuning capacitor	C64-045-0

RESISTORS

IN Ω , %W UNLESS OTHERWISE NOTED. k: k Ω , M: M Ω .

Symbol	Description	Part No.
R1	Carbon film 18k	RD%PS 183JNL
R2	Carbon film 18k	RD%PS 183JNL
R3	Wire wound 150 5W	RT5B 151K
R4	Wire wound 150 5W	RT5B 151K
R5	Wire wound 150 5W	RT5B 151K
R6	Wire wound 150 5W	RT5B 151K
R7	Carbon film 47k	RD%PS 473J
R8	Carbon film 82k	RD%PS B23J
R9	Carbon film 4.7k	RD%PS 472JNL
R10	Carbon film 100k	RD%PS 104JNL
R11	Carbon film 22 %W	RD%PS 220J
R12	Carbon film 2.2M %W	RD%PW 225J

SEMICONDUCTOR

Symbol	Description	Part No.
D1	S1B01-01 Diode	

SWITCHES

Symbol	Description	Part No.
S1	Selector switch	ASB-011-A
S2	Mode switch	S14-035-0
S3	Speakers switch	ASA-020-0
	Relay	ASR-007

COILS AND TRANSFORMERS

Symbol	Description	Part No.
L1	AM ferrite loopstick antenna	ATB-002-0
L2	Choke coil	T24-030-0
L3	Heater choke coil	T24-025-B
L4	Balun transformer	T22-025-A
T1	Power transformer	ATT-058-0

OTHERS

Symbol	Description	Part No.
	FM front end	W11-043-A
	Tuner unit	AWE-016-A
	MPX filter unit	AWX-009-0
	Head amp unit	W21-002-A
	AF unit	AWK-012-0
	Main amp unit	AWH-010-0
	Protection unit	W28-008-A
	Switch unit	AWS-017-0
	Power supply unit	AWR-010-0
	Lamp box unit	AWX-016-0
	Wooden case	AMM-013-B
	Front panel ass'y	ANB-123-C
	Foot	AEC-027-B
	Dial shaft ass'y	AXA-013-0
	Dial pulley ass'y	M42-080-A
	AM ferrite loopstick antenna holder	W72-082-B
	Dial scale	AAG-031-A
	Signal meter	AAW-006-0
	Tuning meter	AAW-007-0
	Dial pointer ass'y	AAF-011-A

Symbol	Description	Part No.
	Knob for tuning	AAA-006-0
	Knob for power, selector, mode, volume and balance	AAB-007-B
	Knob for bass and treble (L)	AAB-013-0
	Knob for bass and treble (R)	AAB-014-0
	Knob for lever switch	AAD-028-0
	Knob for push switch	AAD-026-0
	6P input terminal board (A)	AKB-007-0
	6P input terminal board (B)	AKB-008-0
	Antenna input terminal board	K11-043-D
	4P ground terminal	K13-047-0
	Pilot lamp for dial scale	E22-017-0
	Pilot lamp for meter	AEL-015
	Pilot lamp for program indicator	AEL-007-0
	and speaker indicator	E21-021-0
	Fuse 3A	E21-022-A
	Fuse 3A for protection	E21-019-A
	Fuse 0.5A for protection	W52-004-0
	Compound part for REC jack	AKP-002-0
	Spare AC outlet	K72-028-0
	Speaker socket	K72-026-0
	Headphones jack	K72-024-0
	Microphone jack	K93-003-B
	5P connector (DIN)	AKK-002
	Pilot lamp (for meter) socket	AKR-007-0
	Fuse holder	AKM-002-0
	Jumper plug	K24-002-A
	8P socket (for MC transformer)	K71-030-0
	8P plug	B11-012-A
	Screw for grounding	B11-016-B
	Screw to fix wooden case	D11-003-E
	AC power cord	

Symbol	Description	Part No.
	Speaker plug	K72-007-B
	Pin plug	K72-015-A
	Hexagonal wrench	ANK-018-0
	Operating instructions	ARB-049-0
	FM T-type antenna	D52-013-0
	Packing case	AHD-078-0
	Side pad (L)	AHA-012-A
	Side pad (R)	AHA-013-A
	Cardboard protector	AHB-006-0
	Top pad	AHB-007-0
	Accessory box	AHC-001-0

Symbol	Description	Part No.
	Speaker plug	K72-007-B
	Pin plug	K72-015-A
	Hexagonal wrench	ANK-018-0
	Operating instructions	ARB-049-0
	FM T-type antenna	D52-013-0
	Packing case	AHD-078-0
	Side pad (L)	AHA-012-A
	Side pad (R)	AHA-013-A
	Cardboard protector	AHB-006-0
	Top pad	AHB-007-0
	Accessory box	AHC-001-0

For FVZW model

CAPACITORS

IN μ F UNLESS OTHERWISE NOTED. P: μ MF.

Symbol	Description	Part No.
C1	Ceramic 0.01 50V	CKDYF 103Z 50
C2	Ceramic 0.01 50V	CKDYF 103Z 50
C5	Electrolytic 220 6V	CEA 221P 6
C6	Electrolytic 8000 50V	ACH-015-0
C7	Electrolytic 8000 50V	ACH-015-0
C8	Electrolytic 1000 63V	ACH-001-C
C9	Electrolytic 470 16V	CEB 471P 16
C10	Ceramic 0.01 DC 1.4kV	C43-003-0
C11	Ceramic 0.01 DC 1.4kV	C43-003-0
C12	Ceramic 0.01 DC 1.4kV	C43-003-0
C13	Mylar 0.022 50V	CGMA 223K 50
VC1	AM tuning capacitor	C64-045-0

RESISTORS

IN Ω , %W UNLESS OTHERWISE NOTED. K: k Ω , M: M Ω .

Symbol	Description	Part No.
R1	Carbon film 18k	RD $\frac{1}{2}$ PS 183JNL
R2	Carbon film 18k	RD $\frac{1}{2}$ PS 183JNL
R3	Wire wound 150 5W	RT5B 151K
R4	Wire wound 150 5W	RT5B 151K
R5	Wire wound 150 5W	RT5B 151K
R6	Wire wound 150 5W	RT5B 151K
R7	Carbon film 47k	RD $\frac{1}{2}$ PS 473J
R8	Carbon film 82k	RD $\frac{1}{2}$ PS 823J
R9	Carbon film 4.7k	RD $\frac{1}{2}$ PS 472JNL
R10	Carbon film 100k	RD $\frac{1}{2}$ PS 104JNL
R11	Carbon film 22 $\frac{1}{2}$ W	RD $\frac{1}{2}$ PS 220J

SEMICONDUCTOR

Symbol	Description	Part No.
D1	1S1B01-01 Diode	

SWITCHES

Symbol	Description	Part No.
S1	Selector switch	ASB-011-A
S2	Mode switch	S14-035-0
S3	Speakers switch Relay	ASA-021-0 ASR-001-0

COILS AND TRANSFORMERS

Symbol	Description	Part No.
L1	AM ferrite loopstick antenna	T42-024-A
L2	Choke coil	T24-030-0
L3	Heater choke coil	T24-025-B
L4	Balun transformer	T22-025-A
T1	Power transformer	ATT-059-0

OTHERS

Symbol	Description	Part No.
	FM front end	AWB-005-0
	Tuner unit	AWE-016-A
	MPX filter unit	AWX-009-0
	Head amp unit	W21-002-A
	AF unit	AWK-012-0
	Main amp unit	AWH-010-0
	Protection unit	W28-008-A
	Push switch	ASG-020(SI-A35013)
	Power supply unit	AWR-010-0
	Lamp box unit	AWX-016-0
	Wooden case	AMM-013-B
	Front panel ass'y	ANB-123-C
	Foot	AEC-027-B
	Dial shaft ass'y	AXA-013-0
	Dial pulley ass'y	M42-080-A
	AM ferrite loopstick antenna holder	W72-092-B
	Dial scale	AAG-031-A
	Signal meter	AAW-006-0
	Tuning meter	AAW-007-0
	Dial pointer ass'y	AAF-011-A

Symbol	Description	Part No.
	Knob for tuning	AAA-006-0
	Knob for power, selector, mode, volume and balance	AAB-007-B
	Knob for bass and treble (L)	AAB-013-0
	Knob for bass and treble (R)	AAB-014-0
	Knob for lever switch	AAD-028-0
	Knob for push switch	AAD-026-0
	6P input terminal board (A)	AKB-007-0
	6P input terminal board (B)	AKB-008-0
	Antenna input terminal board	K11-043-D
	4P ground terminal	K13-047-0
	Pilot lamp for dial scale	E22-017-0
	Pilot lamp for meter	AEL-015
	Pilot lamp for program indicator and speaker indicator	AEL-007-0
	Fuse 1.5A	E21-012-0
	Fuse 3A for protection	E21-022-A
	Fuse 0.5A for protection	E21-019-A
	Compound part for REC jack	W52-004-0
	Spare AC outlet	AKP-002-0
	Speaker socket	K72-028-0
	Headphones jack	K72-026-0
	Microphone jack	K72-024-0
	5P connector (DIN)	K93-003-B
	Pilot lamp (for meter) socket	AKK-002
	Line voltage selector	AKR-001-0
	Jumper plug	AKM-002-0
	8P socket (for MC transformer)	K24-002-A
	8P plug	K71-030-0
	Screw for grounding	B11-012-A
	Screw to fix wooden case	B11-016-B
	AC power cord	D11-002-B

For FW model

CAPACITORS

IN μ F UNLESS OTHERWISE NOTED. p: μ F.

Symbol	Description	Part No.
C1	Ceramic	CKDYF 103Z 50
C2	Ceramic	CKDYF 103Z 50
C3	Mylar	COMA 472K 50
C4	Mylar	COMA 472K 50
C5	Electrolytic	CEA 221P 6
C6	Electrolytic	ACH-015-0
C7	Electrolytic	ACH-015-0
C8	Electrolytic	ACH-001-C
C9	Electrolytic	CEB 471P 16
C10	Ceramic	C43-003-0
C11	Ceramic	C43-003-0
C12	Ceramic	C43-003-0
C13	Mylar	COMA 223K 50
VCT	AM tuning capacitor	C64-045-0

RESISTORS

IN Ω , %W UNLESS OTHERWISE NOTED. k: k Ω , M: M Ω .

Symbol	Description	Part No.
R1	Carbon film	RD $\frac{1}{2}$ PS 183JNL
R2	Carbon film	RD $\frac{1}{2}$ PS 183JNL
R3	Wire wound	RT5B 151K
R4	Wire wound	RT5B 151K
R5	Wire wound	RT5B 151K
R6	Wire wound	RT5B 151K
R7	Carbon film	RD $\frac{1}{2}$ PS 473J
R8	Carbon film	RD $\frac{1}{2}$ PS 823J
R9	Carbon film	RD $\frac{1}{2}$ PS 472JNL
R10	Carbon film	RD $\frac{1}{2}$ PS 104JNL
R11	Carbon film	RD $\frac{1}{2}$ PS 220J

SEMICONDUCTOR

Symbol	Description	Part No.
D1	S1B01-01 Diode	

SWITCHES

Symbol	Description	Part No.
S1	Selector switch	ASB-011-A
S2	Mode switch	S14-035-0
S3	Speakers switch	ASA-021-0
S4	De-emphasis switch Relay	S41-022-A ASR-001-0

24 COILS AND TRANSFORMERS

Symbol	Description	Part No.
L1	AM ferrite loopstick antenna	T42-024-A
L2	Choke coil	T24-030-0
L3	Heater choke coil	T24-025-B
L4	Balun transformer	T22-025-A
T1	Power transformer	ATT-059-0

OTHERS

Symbol	Description	Part No.
	FM front end	W11-043-A
	Tuner unit	AWE-016-A
	MPX filter unit	AWX-009-0
	Head amp unit	W21-002-A
	AF unit	AWK-012-0
	Main amp unit	AWH-010-0
	Protection unit	W28-008-A
	Push switch	ASG-020(SI-A35013)
	Power supply unit	AWR-010-0
	Lamp box unit	AWX-016-0
	Wooden case	AMM-013-B
	Front panel ass'y	ANB-123-C
	Foot	AEC-027-B
	Dial shaft ass'y	AXA-013-0
	Dial pulley ass'y	M42-080-A
	AM ferrite loopstick antenna holder	W72-092-B
	Dial scale	AAG-031-A
	Signal meter	AAW-006-0
	Tuning meter	AAW-007-0
	Dial pointer ass'y	AAF-011-A

Symbol	Description	Part No.
	Knob for tuning	AAA-006-0
	Knob for power, selector, mode, volume and balance	AAB-007-B
	Knob for bass and treble (L)	AAB-013-0
	Knob for bass and treble (R)	AAB-014-0
	Knob for lever switch	AAD-028-0
	Knob for push switch	AAD-026-0
	6P input terminal board (A)	AKB-007-0
	6P input terminal board (B)	AKB-008-0
	Antenna input terminal board	K11-043-0
	4P ground terminal	K13-047-0
	Pilot lamp for dial scale	E22-017-0
	Pilot lamp for meter	AEL-015
	Pilot lamp for program indicator and speaker indicator	AEL-007-0
	Fuse 1.5A	E21-012-0
	Fuse 3A for protection	E21-022-A
	Fuse 0.5A for protection	E21-019-A
	Compound part for REC jack	WS2-004-0
	Spare AC outlet	AKP-002-0
	Speaker socket	K72-028-0
	Headphones jack	K72-026-0
	Microphone jack	K72-024-0
	5P connector (DIN)	K93-003-B
	Pilot lamp (for meter) socket	AKK-002
	Line voltage selector	AKR-001-0
	Jumper plug	AKM-002-0
	8P socket (for MC transformer)	K24-002-A
	8P plug	K71-030-0
	Screw for grounding	B11-012-A
	Screw to fix wooden case	B11-016-B
	AC power cord	D11-002-B

Symbol	Description	Part No.
	Speaker plug	K72-007-B
	Pin plug	K72-015-A
	Hexagonal wrench	ANK-018-0
	Operating instructions	ARB-049-0
	FM T-type antenna	D52-013-0
	Packing case	AHD-079-0
	Side pad (L)	AHA-012-A
	Side pad (R)	AHA-013-A
	Cardboard protector	AHB-006-0
	Top pad	AHB-007-0
	Accessory box	AHC-001-0
	Fuse 3A	E21-008-0

9.2 FM FRONT END (W11-043) (AWB-005)

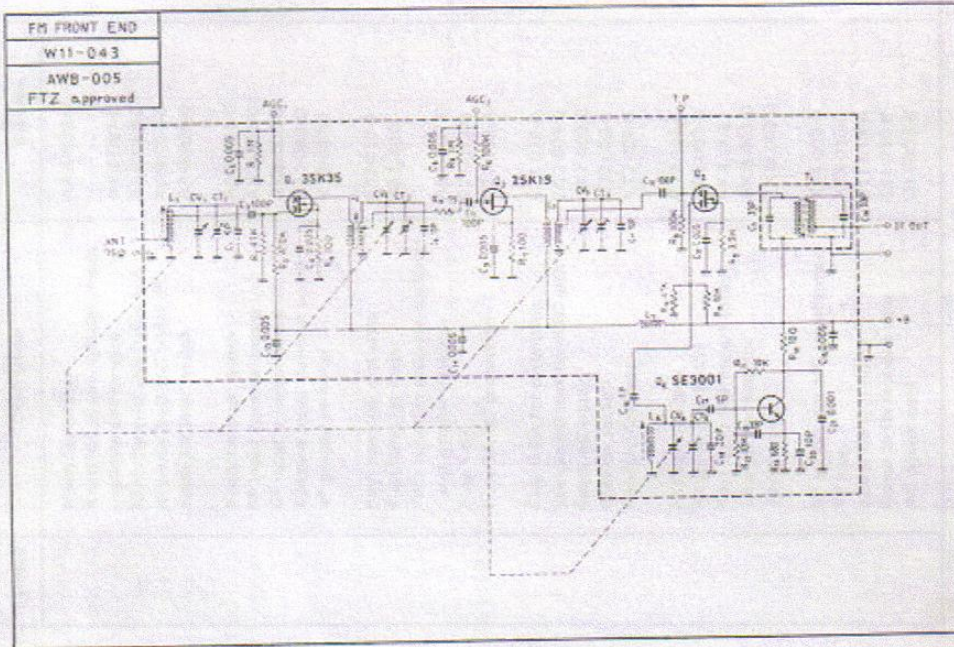

9.3 TUNER UNIT (AWE-016)

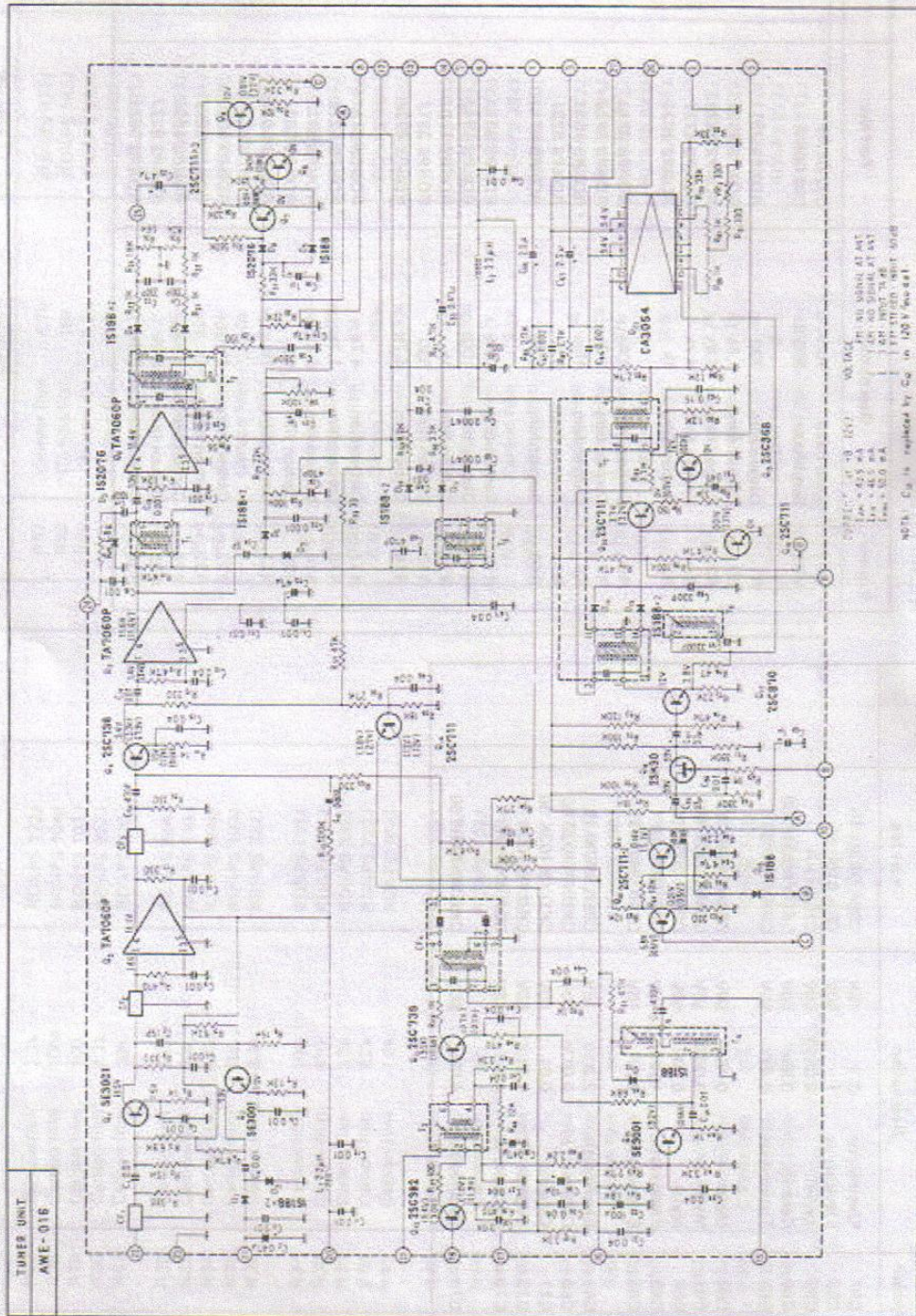

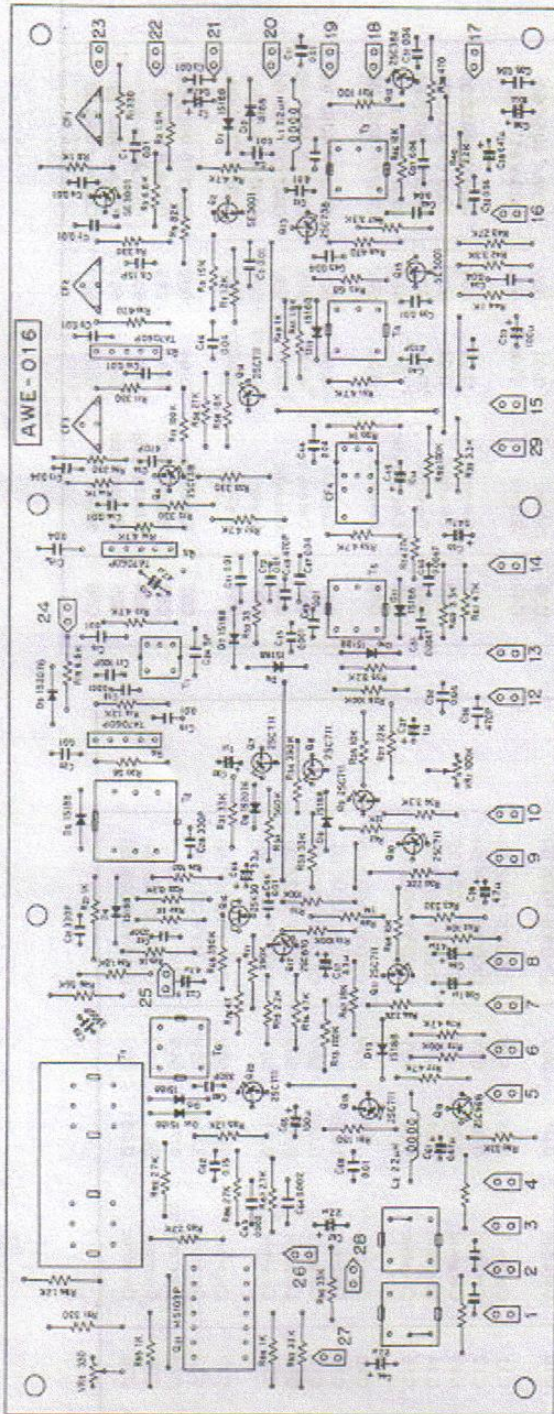

2 PARTS LIST OF TUNER UNIT

CAPACITORS

Symbol	Description	Part No.
C1	Ceramic	CKDYF 103Z 50
C2	Electrolytic	CEA R47P 50
C3	Ceramic	CKDYF 103Z 50
C4	Ceramic	CKDYF 103Z 50
C5	Ceramic	CKDYF 103Z 50
C6	Ceramic	CKDYF 103Z 50
C7	Ceramic	CKDYB 103K 50
C8	Ceramic	CCDSL 150K 50
C9	Ceramic	CKDYF 103Z 50
C10	Ceramic	CKDYB 103K 50
C11	Ceramic	CKDYF 103Z 50
C12	Ceramic	CKDYB 103K 50
C13	Ceramic	CKDYF 403Z 50
C14	Ceramic	CKDYF 103Z 50
C15	Ceramic	CKDYF 403Z 50
C16	Ceramic	CKDYF 103Z 50
C17	Ceramic	CCDSL 101K 50
C18	Ceramic	CKDYB 102K 50
C19	Ceramic	CKDYF 103Z 50
C20	Ceramic	CKDYF 103Z 50
C21	Ceramic	CKDYB 331K 50
C22	Ceramic	CKDYB 331K 50
C23	Electrolytic	CEA 4R7P 50
C24	Ceramic	CCDSL 050D 50
C25	Ceramic	CKDYB 102K 50

Symbol	Description	Part No.
C26	Ceramic	CKDYB 471K 50
C27	Electrolytic	CEA 010P 50
C28	Ceramic	CKDYB 331K 50
C29	Electrolytic	CEA 4R7P 50
C30	Electrolytic	CEA 010P 50
C31	Ceramic	CKDYF 403Z 50
C32	Ceramic	CKDYF 403Z 50
C33	Electrolytic	CEA 101P 16
C34	Ceramic	CKDYF 403Z 50
C35	Ceramic	CKDYF 403Z 50
C36	Electrolytic	CEA 100P 16
C37	Ceramic	CKDYF 403Z 50
C38	Electrolytic	CEA R47P 50
C39	Mylar	COMA 103K 50
C40	Styrol	COMA 411K 50
C42	Ceramic	CKDYF 403Z 50
C43	Ceramic	CKDYF 403Z 50
C44	Ceramic	CKDYF 403Z 50
C45	Electrolytic	CEA 100P 16
C46	Ceramic	CKDYF 403Z 50
C47	Ceramic	CKDYF 403Z 50
C48	Ceramic	CKDYB 471K 50
C49	Ceramic	CKDYF 103Z 50
C50	Mylar	COMA 472K 50
C51	Mylar	COMA 472K 50
C52	Ceramic	CKDYF 403Z 50
C53	Electrolytic	CSSA R47X 25
C54	Electrolytic	CEA 4R7P 50
C55	Electrolytic	CSSA 3R3M 16
C56	Mylar	COMA 103K 50

RESISTORS

Symbol	Description	Part No.
C57	Electrolytic 3.3 16V	CSSA 3R3M 16
C58	Electrolytic 1 50V	CEA 010P 50
C59	Styrol 0.0033 50V	C15-011-A
C60	Ceramic 330p 50V	CKDYB 331K 50
C61	Electrolytic 0.47 50V	CEA R47P 50
C62	Mylar 0.15 50V	COMA 154K 50
C63	Mylar 0.002 50V	COMA 202K 50
C64	Mylar 0.002 50V	COMA 202K 50
C65	Electrolytic 100 16V	CEA 101P 16
C66	Electrolytic 2.2 16V	CSSA 2R2M 16
C67	Electrolytic 2.2 16V	CSSA 2R2M 16
C68	Ceramic 0.01 50V	CKDYF 103Z 50
C71	Ceramic 0.01 50V	CKDYB 103K 50
C72	Ceramic 0.01 50V	CKDYB 103K 50
C73	Electrolytic 47 16V	CEA 470P 16
C74	Ceramic 470p 50V	CKDYB 471K 50

Symbol	Description	Part No.
VR1	Semi-fixed 100K-B	C92-047-0
VR2	Semi-fixed 330-B	C92-065-A
R1	Carbon film 330	RD%PS 331J
R2	Carbon film 1.5k	RD%PS 152J
R3	Carbon film 6.8k	RD%PS 682J
R4	Carbon film 4.7k	RD%PS 472J
R5	Carbon film 1k	RD%PS 102J
R6	Carbon film 330	RD%PS 331J
R7	Carbon film 1.2k	RD%PS 122J
R8	Carbon film 15k	RD%PS 153J
R9	Carbon film 82k	RD%PS 823J
R10	Carbon film 470	RD%PS 471J
R11	Carbon film 330	RD%PS 331J
R13	Carbon film 100k	RD%PS 104J
R14	Carbon film 1k	RD%PS 102J
R15	Carbon film 330	RD%PS 331J
R16	Carbon film 4.7k	RD%PS 472J
R17	Carbon film 4.7k	RD%PS 472J
R18	Carbon film 1.2k	RD%PS 122J
R19	Carbon film 6.8k	RD%PS 682J
R20	Carbon film 56	RD%PS 560J
R21	Carbon film 1k	RD%PS 102J
R22	Carbon film 1k	RD%PS 102J
R23	Carbon film 1k	RD%PS 102J
R24	Carbon film 1.8k	RD%PS 182J
R25	Carbon film 8.2k	RD%PS 822J
R26	Carbon film 5.6k	RD%PS 562J

Symbol	Description	Part No.
R57	Carbon film	RD½PS 472J
R58	Carbon film	RD½PS 183J
R59	Carbon film	RD½PS 822J
R60	Carbon film	RD½PS 332J
R61	Carbon film	RD½PS 472J
R62	Carbon film	RD½PS 123J
R63	Carbon film	RD½PS 331J
R64	Carbon film	RD½PS 103J
R65	Carbon film	RD½PS 103J
R66	Carbon film	RD½PS 222J
R67	Carbon film	RD½PS 183J
R68	Carbon film	RD½PS 394J
R69	Carbon film	RD½PS 105J
R70	Carbon film	RD½PS 104J
R71	Carbon film	RD½PS 394J
R72	Carbon film	RD½PS 104J
R73	Carbon film	RD½PS 124J
R74	Carbon film	RD½PS 473J
R75	Carbon film	RD½PS 222J
R76	Carbon film	RD½PS 470J
R77	Carbon film	RD½PS 472J
R78	Carbon film	RD½PS 104J
R79	Carbon film	RD½PS 473J
R80	Carbon film	RD½PS 333J
R81	Carbon film	RD½PS 151J
R82	Carbon film	RD½PS 272J
R83	Carbon film	RD½PS 122J
R84	Carbon film	RD½PS 122J
R85	Carbon film	RD½PS 272J
R86	Carbon film	RD½PS 272J

Symbol	Description	Part No.
R27	Carbon film	RD½PS 222J
R28	Carbon film	RD½PS 104J
R29	Carbon film	RD½PS 101J
R30	Carbon film	RD½PS 222J
R31	Carbon film	RD½PS 333J
R32	Carbon film	RD½PS 564J
R33	Carbon film	RD½PS 333J
R34	Carbon film	RD½PS 394J
R35	Carbon film	RD½PS 103J
R36	Carbon film	RD½PS 332J
R37	Carbon film	RD½PS 101J
R38	Carbon film	RD½PS 471J
R39	Carbon film	RD½PS 332J
R40	Carbon film	RD½PS 222J
R41	Carbon film	RD½PS 182J
R42	Carbon film	RD½PS 332J
R43	Carbon film	RD½PS 273J
R44	Carbon film	RD½PS 102J
R45	Carbon film	RD½PS 680J
R46	Carbon film	RD½PS 123J
R47	Carbon film	RD½PS 332J
R48	Carbon film	RD½PS 471J
R49	Carbon film	RD½PS 102J
R50	Carbon film	RD½PS 102J
R51	Carbon film	RD½PS 472J
R52	Carbon film	RD½PS 104J
R53	Carbon film	RD½PS 472J
R54	Carbon film	RD½PS 273J
R55	Carbon film	RD½PS 331J
R56	Carbon film	RD½PS 273J

Symbol	Description	Part No.
R87	Carbon film 2.7k	RD½PS 272J
R88	Carbon film 1k	RD½PS 102J
R89	Carbon film 1k	RD½PS 102J
R90	Carbon film 33k	RD½PS 333J
R91	Carbon film 330	RD½PS 331J
R92	Carbon film 33k	RD½PS 333J
R93	Carbon film 33	RD½PS 330J
R95	Carbon film 330	RD½PS 331J

SEMICONDUCTORS

Symbol	Description	Part No.
Q1	SE3001 Transistor	
Q2	SE3001 Transistor	
Q3	TA7060P-R or W IC	
Q4	2SC738-D Transistor	
Q5	TA7060P-W IC	
Q6	TA7060P-W IC	
Q7	2SC711-F or E Transistor	
Q8	2SC711-F or E Transistor	
Q9	2SC711-F or E Transistor	
Q10	2SC711-F or E Transistor	
Q11	2SC711-F or E Transistor	
Q12	2SC382 Transistor	
Q13	2SC738-D Transistor	
Q14	2SC711-F or E Transistor	
Q15	SE3001 Transistor	
Q16	2SK30-Y or GR FET	
Q17	2SC870-F or E Transistor	
Q18	2SC711-F or E Transistor	
Q19	2SC968-Y Transistor	
Q20	2SC711-F or E Transistor	

Symbol	Description	Part No.
Q21	M5109P or CA3054 IC	
D1	1S188FM-1 Diode	
D2	1S188FM-1 Diode	
D3	1S2076 Diode	
D4	1S188FM-1 Diode	
D5	1S188FM-1 Diode	
D6	1S188FM-1 Diode	
D7	1S188FM-1 Diode	
D8	1S2076 Diode	
D9	1S188FM-1 Diode	
D10	1S188FM-1 Diode	
D11	1S188FM-1 Diode	
D12	1S188FM-1 Diode	
D13	1S188FM-1 Diode	
D14	1S188FM-1 Diode	
D15	1S188FM-1 Diode	

FILTERS

Symbol	Description	Part No.
CF1	FM Ceramic filter	ATF-003-0
CF2	FM Ceramic filter	ATF-001-0
CF3	FM Ceramic filter	ATF-001-0
CF4	AM Ceramic filter	ATF-002-A

COILS AND TRANSFORMERS

Symbol	Description	Part No.
T1	Matching transformer	ATE-002-0
T2	FM IF transformer	T74-003-A
T3	AM RF transformer	ATB-003-A
T4	AM OSC transformer	ATB-004-B
T5	AM IF transformer	ATE-003-B
T6	19kHz coil	A75-023-B
T7	MPX transformer	ATM-005-0
L1	RF choke coil	T24-028-A
L2	RF choke coil	T24-028-A

9.4 MPX FILTER UNIT (AWX-009)

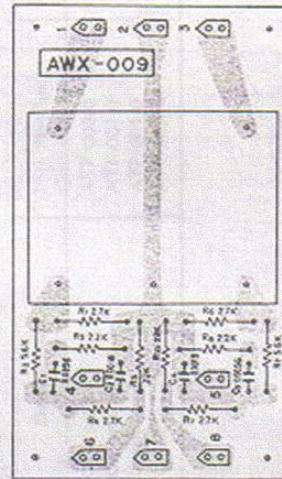
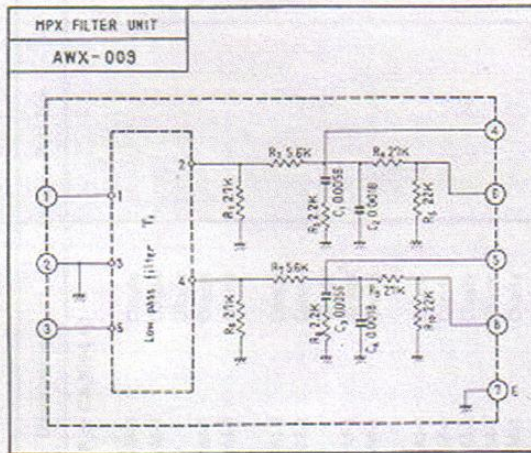

PARTS LIST OF MPX FILTER UNIT

CAPACITORS

Symbol	Description	Part No.
C1	Mylar 0.0056 50V	CQMA 562J 50
C2	Mylar 0.0018 50V	CQMA 182J 50
C3	Mylar 0.0056 50V	CQMA 562J 50
C4	Mylar 0.0018 50V	CQMA 182J 50

RESISTORS

Symbol	Description	Part No.
R1	Carbon film 2.7k	RD4PS 272J
R2	Carbon film 5.6k	RD4PS 562J
R3	Carbon film 2.2k	RD4PS 222J
R4	Carbon film 27k	RD4PS 273J
R5	Carbon film 22k	RD4PS 223J
R6	Carbon film 2.7k	RD4PS 272J
R7	Carbon film 5.6k	RD4PS 562J
R8	Carbon film 2.2k	RD4PS 222J
R9	Carbon film 27k	RD4PS 273J
R10	Carbon film 22k	RD4PS 223J

FILTER

Symbol	Description	Part No.
T1	Low pass filter	T63-010-A

9.5 HEAD AMP UNIT (W21-002)

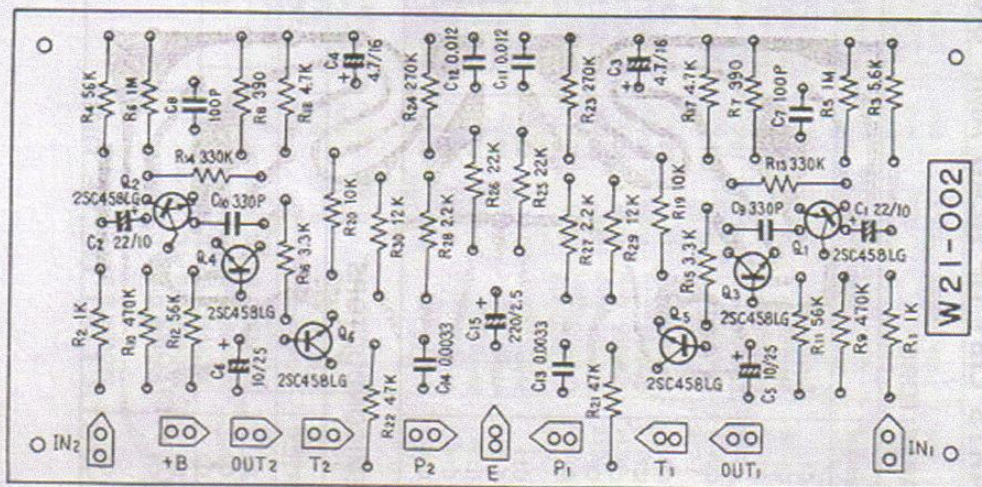
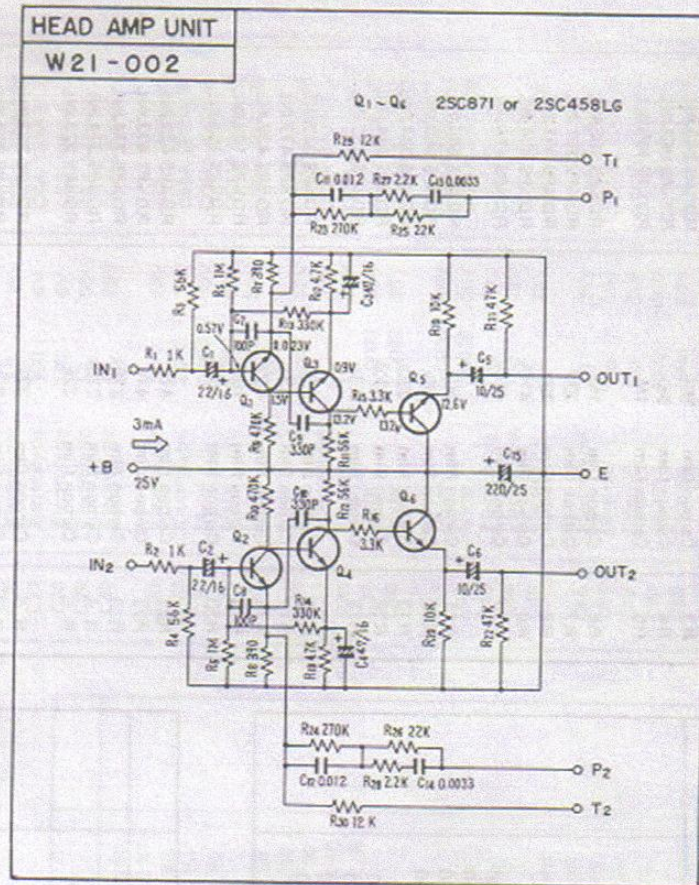

PARTS LIST OF HEAD AMP UNIT

CAPACITORS

Symbol	Description	Part No.
C1	Electrolytic 22 10V	CEA 220P 10
C2	Electrolytic 22 10V	CEA 220P 10
C3	Electrolytic 4.7 16V	CEA 4R7P 16
C4	Electrolytic 4.7 16V	CEA 4R7P 16
C5	Electrolytic 10 25V	CEA 100P 25
C6	Electrolytic 10 25V	CEA 100P 25
C7	Ceramic 100p	CCDSL 101K 50
C8	Ceramic 100p	CCDSL 101K 50
C9	Ceramic 330p	CCDSL 331K 50
C10	Ceramic 330p	CCDSL 331K 50
C11	Mylar 0.01 50V	COMA 103K 50
C12	Mylar 0.01 50V	COMA 103K 50
C13	Mylar 0.0033 50V	COMA 332K 50
C14	Mylar 0.0033 50V	COMA 332K 50
C15	Electrolytic 220 25V	CEA 221P 25

SEMICONDUCTORS

Symbol	Description	Part No.
Q1	2SC458LG-B or C Transistor	
Q2	2SC458LG-B or C Transistor	
Q3	2SC458LG-B or C Transistor	
Q4	2SC458LG-B or C Transistor	
Q5	2SC458LG-B or C Transistor	
Q6	2SC458LG-B or C Transistor	

RESISTORS

Symbol	Description	Part No.
R1	Carbon film 1k	RD½PS 102JNL
R2	Carbon film 1k	RD½PS 102JNL
R3	Carbon film 56k	RD½PS 563JNL
R4	Carbon film 56k	RD½PS 563JNL
R5	Carbon film 1M	RD½PS 105JNL
R6	Carbon film 1M	RD½PS 105JNL
R7	Carbon film 390	RD½PS 391JNL
R8	Carbon film 390	RD½PS 391JNL
R9	Carbon film 470k	RD½PS 474JNL
R10	Carbon film 470k	RD½PS 474JNL
R11	Carbon film 56k	RD½PS 563JNL
R12	Carbon film 56k	RD½PS 563JNL
R13	Carbon film 330k	RD½PS 334JNL
R14	Carbon film 330k	RD½PS 334JNL
R15	Carbon film 3.3k	RD½PS 332JNL
R16	Carbon film 3.3k	RD½PS 332JNL
R17	Carbon film 4.7k	RD½PS 472JNL
R18	Carbon film 4.7k	RD½PS 472JNL
R19	Carbon film 10k	RD½PS 103JNL
R20	Carbon film 10k	RD½PS 103JNL
R21	Carbon film 47k	RD½PS 473JNL
R22	Carbon film 47k	RD½PS 473JNL
R23	Carbon film 270k	RD½PS 274JNL
R 4	Carbon film 270k	RD½PS 274JNL
R 5	Carbon film 22k	RD½PS 223JNL
R 6	Carbon film 22k	RD½PS 223JNL
R 7	Carbon film 2.2k	RD½PS 222JNL
R 8	Carbon film 2.2k	RD½PS 222JNL
R 9	Carbon film 12k	RD½PS 123JNL
R 0	Carbon film 12k	RD½PS 123JNL

9.6 AF UNIT (AWK-012)

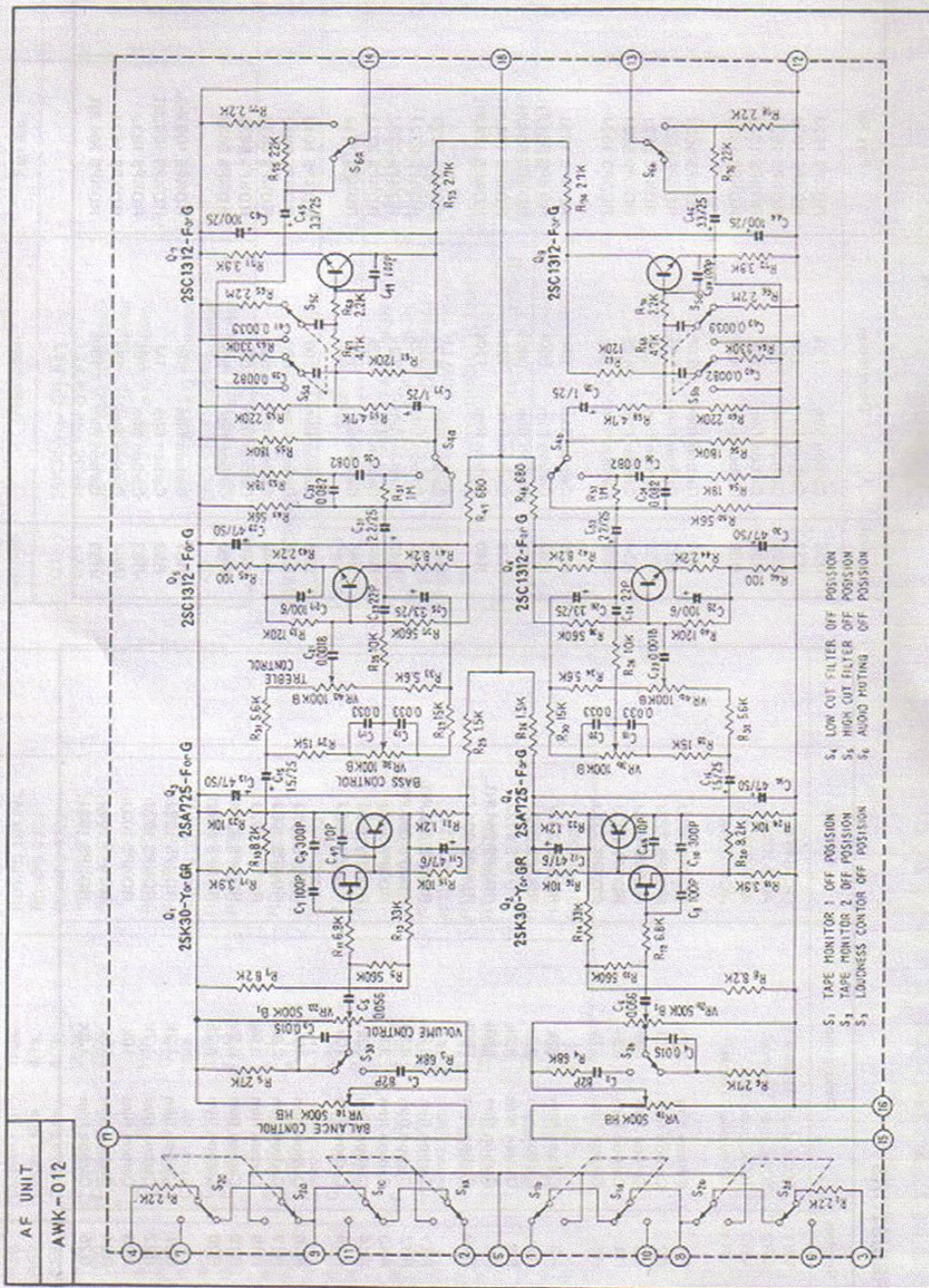

S₁ TAPE MONITOR 1 OFF POSITION
 S₂ TAPE MONITOR 2 OFF POSITION
 S₃ LOUDNESS CONTROL OFF POSITION
 S₄ LOW CUT FILTER OFF POSITION
 S₅ HIGH CUT FILTER OFF POSITION
 S₆ AUDIO MUTING OFF POSITION

AF UNIT
 AWK-012

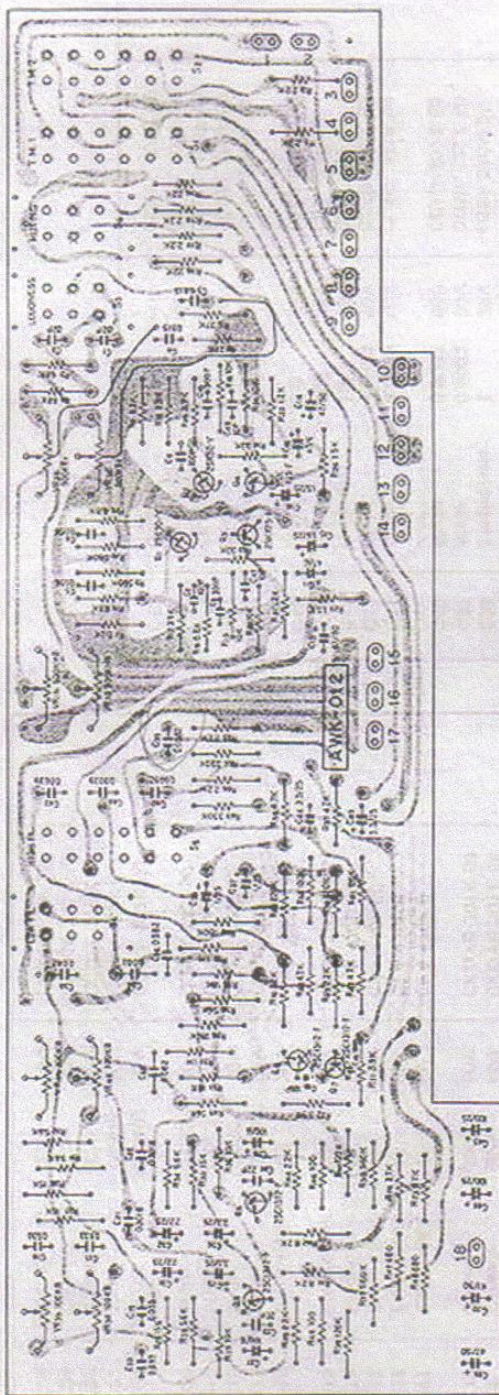

PARTS LIST OF AF UNIT

CAPACITORS

Symbol	Description	Part No.
C1	Ceramic	CCDSL 820K 50
C2	Ceramic	CCDSL 820K 50
C3	Mylar	COMA 153K 50
C4	Mylar	COMA 153K 50
C5	Mylar	COMA 563K 50
C6	Mylar	COMA 563K 50
C7	Ceramic	CCDSL 101K 50
C8	Ceramic	CCDSL 101K 50
C9	Ceramic	CKDYB 301K 50
C10	Ceramic	CKDYB 301K 50
C11	Electrolytic	CEA 470P 6
C12	Electrolytic	CEA 470P 6
C13	Electrolytic	CEA 470P 50
C14	Electrolytic	CEA 470P 50
C15	Electrolytic	CSSA 1R5M 25
C16	Electrolytic	CSSA 1R5M 25
C17	Mylar	COMA 333J 50
C18	Mylar	COMA 333J 50
C19	Mylar	COMA 333J 50
C20	Mylar	COMA 333J 50
C21	Mylar	COMA 182K 50
C22	Mylar	COMA 182K 50
C23	Ceramic	CCDSL 220K 50
C24	Ceramic	CCDSL 220K 50
C25	Electrolytic	CCSA 3R3M 25

Symbol	Description	Part No.
C26	Electrolytic	CCSA 3R3M 25
C27	Electrolytic	CEA 101P 6
C28	Electrolytic	CEA 101P 6
C29	Electrolytic	CEA 470P 50
C30	Electrolytic	CEA 470P 50
C31	Electrolytic	CSSA 2R2M 25
C32	Electrolytic	CSSA 2R2M 25
C33	Mylar	COMA 823K 50
C34	Mylar	COMA 823K 50
C35	Mylar	COMA 823K 50
C36	Mylar	COMA 823K 50
C37	Electrolytic	CSSA 010M 25
C38	Electrolytic	CSSA 010M 25
C39	Mylar	COMA 822K 50
C40	Mylar	COMA 822K 50
C41	Mylar	COMA 392K 50
C42	Mylar	COMA 392K 50
C43	Electrolytic	CEA 101P 25
C44	Electrolytic	CEA 101P 25
C45	Electrolytic	CSSA 3R3M 25
C46	Electrolytic	CSSA 3R3M 25
C47	Ceramic	CCDSL 100F 50
C48	Ceramic	CCDSL 100F 50
C49	Ceramic	CCDSL 101K 50
C50	Ceramic	CCDSL 101K 50

RESISTORS

Symbol	Description	Part No.
R26	Carbon film	RD½PS 152J
R27	Carbon film	RD½PS 153J
R28	Carbon film	RD½PS 153J
R29	Carbon film	RD½PS 153J
R30	Carbon film	RD½PS 153J
R31	Carbon film	RD½PS 562J
R32	Carbon film	RD½PS 562J
R33	Carbon film	RD½PS 562J
R34	Carbon film	RD½PS 562J
R35	Carbon film	RD½PS 103J
R36	Carbon film	RD½PS 103J
R37	Carbon film	RD½PS 564JNL
R38	Carbon film	RD½PS 564JNL
R39	Carbon film	RD½PS 124JNL
R40	Carbon film	RD½PS 124JNL
R41	Carbon film	RD½PS 822J
R42	Carbon film	RD½PS 822J
R43	Carbon film	RD½PS 222J
R44	Carbon film	RD½PS 222J
R45	Carbon film	RD½PS 101J
R46	Carbon film	RD½PS 101J
R47	Carbon film	RD½PS 681J
R48	Carbon film	RD½PS 681J
R49	Carbon film	RD½PS 563J
R50	Carbon film	RD½PS 563J
R51	Carbon film	RD½PS 105JNL
R52	Carbon film	RD½PS 105JNL
R53	Carbon film	RD½PS 183J
R54	Carbon film	RD½PS 183J
R55	Carbon film	RD½PS 184JNL

Symbol	Description	Part No.
VR1	500k, dual, Balance	C82-049-0
VR2	500k, dual, Volume	ACV-105-0
VR3	100k, dual, Bass	ACV-202-A
VR4	100k, dual, Treble	ACV-202-A
R1	Carbon film	RD½PS 222J
R2	Carbon film	RD½PS 222J
R3	Carbon film	RD½PS 683J
R4	Carbon film	RD½PS 683J
R5	Carbon film	RD½PS 273J
R6	Carbon film	RD½PS 273J
R7	Carbon film	RD½PS 822J
R8	Carbon film	RD½PS 822J
R9	Carbon film	RD½PS 564JNL
R10	Carbon film	RD½PS 564JNL
R11	Carbon film	RD½PS 682JNL
R12	Carbon film	RD½PS 682JNL
R13	Carbon film	RD½PS 333J
R14	Carbon film	RD½PS 333J
R15	Carbon film	RD½PS 103J
R16	Carbon film	RD½PS 103J
R17	Carbon film	RD½PS 392J
R18	Carbon film	RD½PS 392J
R19	Carbon film	RD½PS 822J
R20	Carbon film	RD½PS 822J
R21	Carbon film	RD½PS 122J
R22	Carbon film	RD½PS 122J
R23	Carbon film	RD½PS 103J
R24	Carbon film	RD½PS 103J
R25	Carbon film	RD½PS 152J

SEMICONDUCTORS

Symbol	Description	Part No.
Q1	2SK30-Y or GR FET	
Q2	2SK30-Y or GR FET	
Q3	2SA725-F or G Transistor	
Q4	2SA725-F or G Transistor	
Q5	2SC1312-F or G Transistor	
Q6	2SC1312-F or G Transistor	
Q7	2SC1312-F or G Transistor	
Q8	2SC1312-F or G Transistor	

SWITCHES

Symbol	Description	Part No.
S1	Lever switch (TAPE MON 1)	ASK-015-0
S2	Lever switch (TAPE MON 2)	ASK-015-0
S3	Lever switch (LOUDNESS)	ASK-014-0 ♂
S4	Lever switch (LOW FILTER)	ASK-014-0 ♂
S5	Lever switch (HIGH FILTER)	ASK-016-0
S6	Lever switch (AUDIO MUTING)	ASK-014-0 ♂

Symbol	Description	Part No.
R56	Carbon film 180k	RD½PS 184JNL
R57	Carbon film 4.7k	RD½PS 472J
R58	Carbon film 4.7k	RD½PS 472J
R59	Carbon film 220k	RD½PS 224JNL
R60	Carbon film 220k	RD½PS 224JNL
R61	Carbon film 120k	RD½PS 124JNL
R62	Carbon film 120k	RD½PS 124JNL
R63	Carbon film 330k	RD½PS 334JNL
R64	Carbon film 330k	RD½PS 334JNL
R65	Carbon film 2.2M	RD½PS 225J
R66	Carbon film 2.2M	RD½PS 225J
R67	Carbon film 4.7k	RD½PS 472J
R68	Carbon film 4.7k	RD½PS 472J
R69	Carbon film 2.2k	RD½PS 222J
R70	Carbon film 2.2k	RD½PS 222J
R71	Carbon film 3.9k	RD½PS 392J
R72	Carbon film 3.9k	RD½PS 392J
R73	Carbon film 2.7k	RD½PS 272J
R74	Carbon film 2.7k	RD½PS 272J
R75	Carbon film 22k	RD½PS 223J
R76	Carbon film 22k	RD½PS 223J
R77	Carbon film 2.2k	RD½PS 222J
R78	Carbon film 2.2k	RD½PS 222J

SEMICONDUCTORS

Symbol	Description	Part No.
Q1	2SK30-Y or GR FET	
Q2	2SK30-Y or GR FET	
Q3	2SA725-F or G Transistor	
Q4	2SA725-F or G Transistor	
Q5	2SC1312-F or G Transistor	
Q6	2SC1312-F or G Transistor	
Q7	2SC1312-F or G Transistor	
Q8	2SC1312-F or G Transistor	

SWITCHES

Symbol	Description	Part No.
S1	Lever switch (TAPE MON 1)	ASK-015-0
S2	Lever switch (TAPE MON 2)	ASK-015-0
S3	Lever switch (LOUDNESS)	ASK-014-0 ^φ
S4	Lever switch (LOW FILTER)	ASK-014-0 ^φ
S5	Lever switch (HIGH FILTER)	ASK-016-0
S6	Lever switch (AUDIO MUTING)	ASK-014-0 ^φ

Symbol	Description	Part No.
R56	Carbon film 180k	RD4PS 184JNL
R57	Carbon film 4.7k	RD4PS 472J
R58	Carbon film 4.7k	RD4PS 472J
R59	Carbon film 220k	RD4PS 224JNL
R60	Carbon film 220k	RD4PS 224JNL
R61	Carbon film 120k	RD4PS 124JNL
R62	Carbon film 120k	RD4PS 124JNL
R63	Carbon film 330k	RD4PS 334JNL
R64	Carbon film 330k	RD4PS 334JNL
R65	Carbon film 2.2M	RD4PS 225J
R66	Carbon film 2.2M	RD4PS 225J
R67	Carbon film 4.7k	RD4PS 472J
R68	Carbon film 4.7k	RD4PS 472J
R69	Carbon film 2.2k	RD4PS 222J
R70	Carbon film 2.2k	RD4PS 222J
R71	Carbon film 3.9k	RD4PS 392J
R72	Carbon film 3.9k	RD4PS 392J
R73	Carbon film 2.7k	RD4PS 272J
R74	Carbon film 2.7k	RD4PS 272J
R75	Carbon film 22k	RD4PS 223J
R76	Carbon film 22k	RD4PS 223J
R77	Carbon film 2.2k	RD4PS 222J
R78	Carbon film 2.2k	RD4PS 222J

9.7 MAIN AMP UNIT (AWH-010)

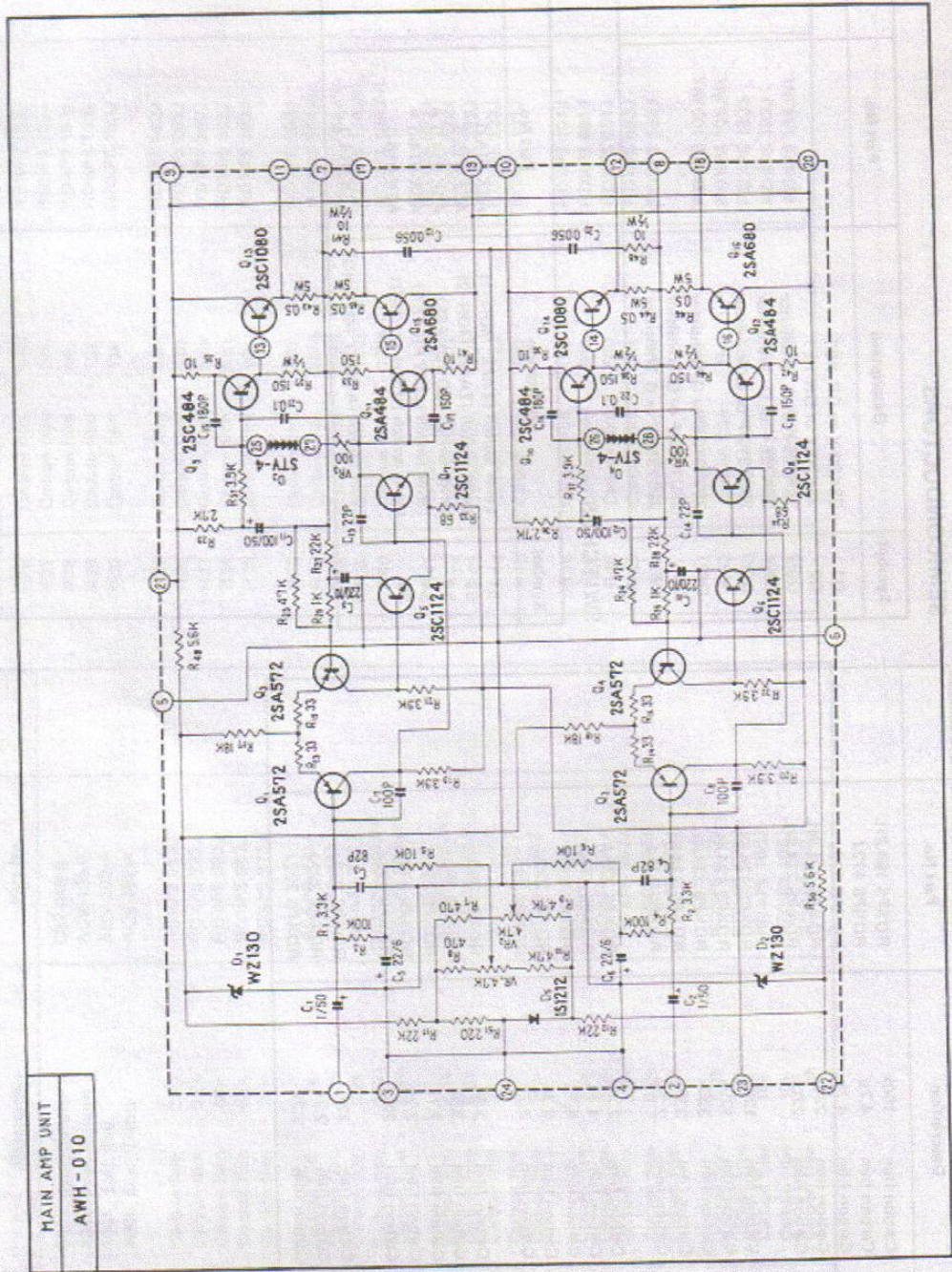

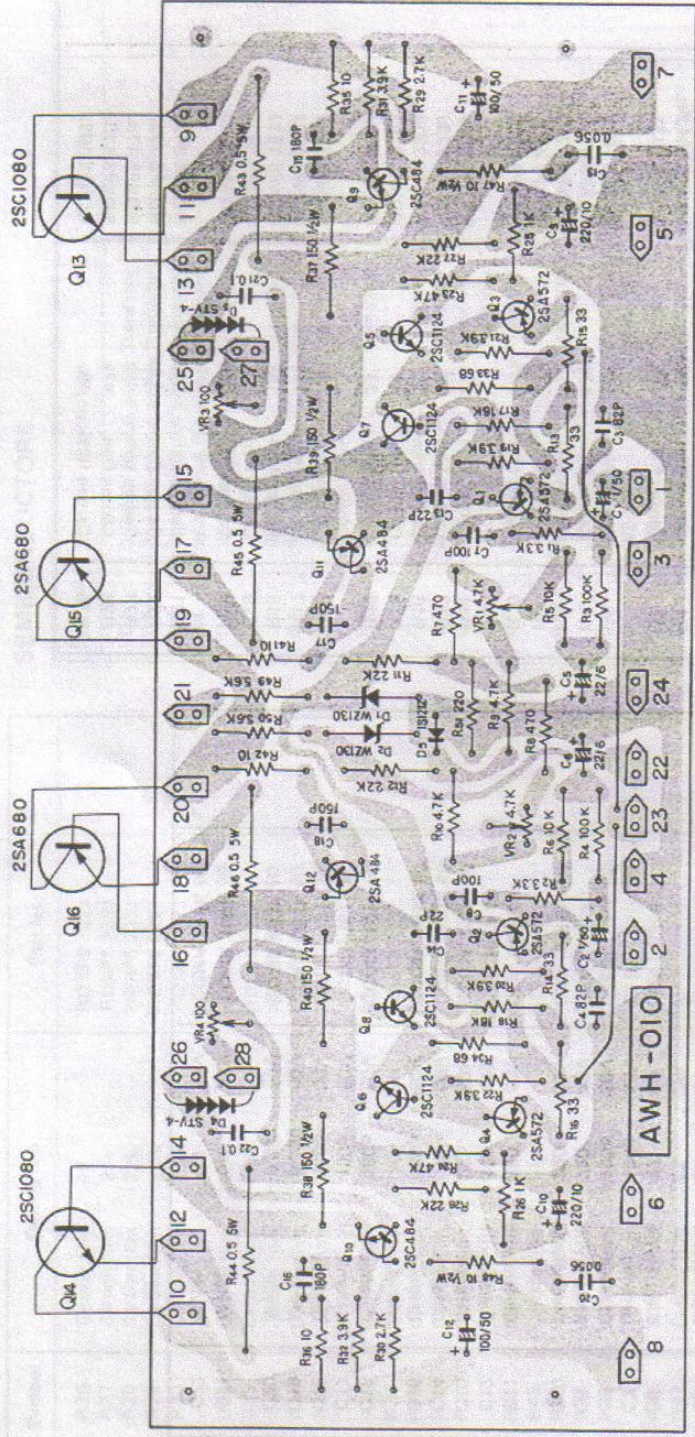

± PARTS LIST OF MAIN AMP UNIT

CAPACITORS

Symbol	Description	Part No.
C1	Electrolytic 1 50V	CEA 010P 50
C2	Electrolytic 1 50V	CEA 010P 50
C3	Ceramic 82p 50V	CCDSL 820K 50
C4	Ceramic 82p 50V	CCDSL 820K 50
C5	Electrolytic 22 6V	CEA 220P 6
C6	Electrolytic 22 6V	CEA 220P 6
C7	Ceramic 100p 50V	CCDSL 101K 50
C8	Ceramic 100p 50V	CCDSL 101K 50
C9	Electrolytic 220 10V	CEA 221P 10
C10	Electrolytic 220 10V	CEA 221P 10
C11	Electrolytic 100 50V	CEA 101P 50
C12	Electrolytic 100 50V	CEA 101P 50
C13	Ceramic 22p 50V	CCDSL 220K 50
C14	Ceramic 22p 50V	CCDSL 220K 50
C15	Ceramic 180p 50V	CCDSL 181K 50
C16	Ceramic 180p 50V	CCDSL 181K 50
C17	Ceramic 150p 50V	CCDSL 151K 50
C18	Ceramic 150p 50V	CCDSL 151K 50
C19	Mylar 0.056 50V	QOMA 563K 50
C20	Mylar 0.056 50V	QOMA 563K 50
C21	Mylar 0.1 50V	COMA 104K 50
C22	Mylar 0.1 50V	COMA 104K 50

RESISTORS

Symbol	Description	Part No.
VR1	Semi-fixed 4.7k-B	C92-051-0
VR2	Semi-fixed 4.7k-B	C92-051-0
VR3	Semi-fixed 100-B	C92-063-0
VR4	Semi-fixed 100-B	C92-063-0
R1	Carbon film 3.3k	RD½PS 332J
R2	Carbon film 3.3k	RD½PS 332J
R3	Carbon film 100k	RD½PS 104JNL
R4	Carbon film 100k	RD½PS 104JNL
R5	Carbon film 10k	RD½PS 103J
R6	Carbon film 10k	RD½PS 103J
R7	Carbon film 470	RD½PS 471J
R8	Carbon film 470	RD½PS 471J
R9	Carbon film 4.7k	RD½PS 472J
R10	Carbon film 4.7k	RD½PS 472J
R11	Carbon film 22k	RD½PS 223J
R12	Carbon film 22k	RD½PS 223J
R13	Carbon film 33	RD½PS 330J
R14	Carbon film 33	RD½PS 330J
R15	Carbon film 33	RD½PS 330J
R16	Carbon film 33	RD½PS 330J
R17	Carbon film 18k	RD½PS 183J
R18	Carbon film 18k	RD½PS 183J
R19	Carbon film 3.9k	RD½PS 392J
R20	Carbon film 3.9k	RD½PS 392J
R21	Carbon film 3.9k	RD½PS 392J
R22	Carbon film 3.9k	RD½PS 392J
R23	Carbon film 47k	RD½PS 473J
R24	Carbon film 47k	RD½PS 473J
R25	Carbon film 1k	RD½PS 102J

SEMICONDUCTORS

Symbol	Description	Part No.
R26	Carbon film 1k	RD½PS 102J
R27	Carbon film 22k	RD½PS 223J
R28	Carbon film 22k	RD½PS 223J
R29	Carbon film 2.7k	RD½PS 272J
R30	Carbon film 2.7k	RD½PS 272J
R31	Carbon film 3.9k	RD½PS 392J
R32	Carbon film 3.9k	RD½PS 392J
R33	Carbon film 68	RD½PS 680J
R34	Carbon film 68	RD½PS 680J
R35	Carbon film 10	RD½PS 100J
R36	Carbon film 10	RD½PS 100J
R37	Carbon film 150 ½W	RD½PS 151J
R38	Carbon film 150 ½W	RD½PS 151J
R39	Carbon film 150 ½W	RD½PS 151J
R40	Carbon film 150 ½W	RD½PS 151J
R41	Carbon film 10	RD½PS 100J
R42	Carbon film 10	RD½PS 100J
R43	Wire wound 0.5 5W	RT5B 0R5K
R44	Wire wound 0.5 5W	RT5B 0R5K
R45	Wire wound 0.5 5W	RT5B 0R5K
R46	Wire wound 0.5 5W	RT5B 0R5K
R47	Carbon film 10 ½W	RD½PS 100J
R48	Carbon film 10 ½W	RD½PS 100J
R49	Carbon film 5.6k	RD½PS 562J
R50	Carbon film 5.6k	RD½PS 562J
R51	Carbon film 220	RD½PS 221J

Symbol	Description	Part No.
Q1	2SA572-4B, 5A or 5B Transistor	
Q2	2SA572 4B, 5A or 5B Transistor	
Q3	2SA572-4B, 5A or 5B Transistor	
Q4	2SA572-4B, 5A or 5B Transistor	
Q5	2SC1124-2 or 3 Transistor	
Q6	2SC1124-2 or 3 Transistor	
Q7	2SC1124-2 or 3 Transistor	
Q8	2SC1124-2 or 3 Transistor	
Q9	2SC484-Y or BL Transistor	
Q10	2SC484-Y or BL Transistor	
Q11	2SA484-Y or BL Transistor	
Q12	2SA484-Y or BL Transistor	
Q13	2SC1080 Transistor	
Q14	2SC1080 Transistor	
Q15	2SA680 Transistor	
Q16	2SA680 Transistor	
D1	WZ-130 Zener diode	
D2	WZ-130 Zener diode	
D3	STV-4 Varistor	
D4	STV-4 Varistor	
D5	1S1212 Diode	

PARTS LIST OF POWER SUPPLY UNIT

CAPACITORS

Symbol	Description	Part No.
C1	Ceramic 0.01 DC1.4kV	C43-003-0
C2	Ceramic 0.01 DC1.4kV	C43-003-0
C3	Ceramic 0.01 DC1.4kV	C43-003-0
C4	Ceramic 0.01 DC1.4kV	C43-003-0
C5	Electrolytic 1000 10V	CEA 102P 10
C6	Electrolytic 100 50V	CEA 101P 50
C7	Electrolytic 100 50V	CEA 101P 50
C8	Electrolytic 100 50V	CEA 101P 50
C9	Electrolytic 100 50V	CEA 101P 50
C10	Electrolytic 220 16V	CEA 221P 16
C11	Ceramic 100p	CCDSL 101K 50
C12	Electrolytic 220 35V	CEA 221P 35
C13	Electrolytic 470 16V	CEA 471P 16
C14	Ceramic 0.01 DC1.4kV	C43-003-0

RESISTORS

Symbol	Description	Part No.
R1	Carbon film 330	RD½PS 331J
R2	Carbon film 10	RD½PS 100J
R3	Carbon film 1.5k	RD½PS 152J
R4	Carbon film 1.5k	RD½PS 152J
R5	Carbon film 3.3k	RD½PS 332J
R6	Carbon film 27k	RD½PS 273J
R7	Carbon film 18k	RD½PS 183J
R8	Carbon film 330	RD½PS 331J
R9	Carbon film 100	RD½PS 101J
R10	Carbon film 220	RD½PS 221J

Symbol	Description	Part No.
R11	Carbon film 330k	RD½PS 334J
R12	Metal oxide 330	RS2P 331K
R13	Carbon film 4.7	RD½PS 4R7J
R14	Carbon film 3.3k	RD½PS 332J
R15	Metal oxide 10	RN2P 100K
R16	Metal oxide 10	RN2P 100K

SEMICONDUCTORS

Symbol	Description	Part No.
Q1	2SD234P-O Transistor	
Q2	2SC373 Transistor	
Q3	2SD313 Transistor	
D1	SR3AM-8 Diode	
D2	SR3AM-8 Diode	
D3	SR3AM-8 Diode	
D4	SR3AM-8 Diode	
D5	FR2-02 Diode	
D6	1S1850 Diode	
D7	WZ-130 Zener diode	

COILS

Symbol	Description	Part No.
L1	AF choke coil	T63-009-A
L2	AF choke coil	T63-009-A

SX-828

9.9 PROTECTION UNIT (W28-008)

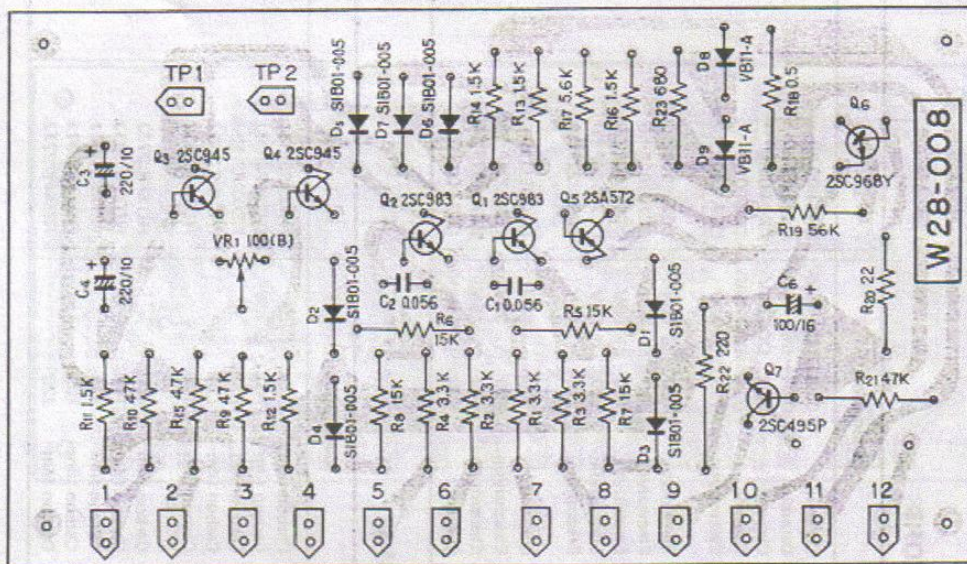
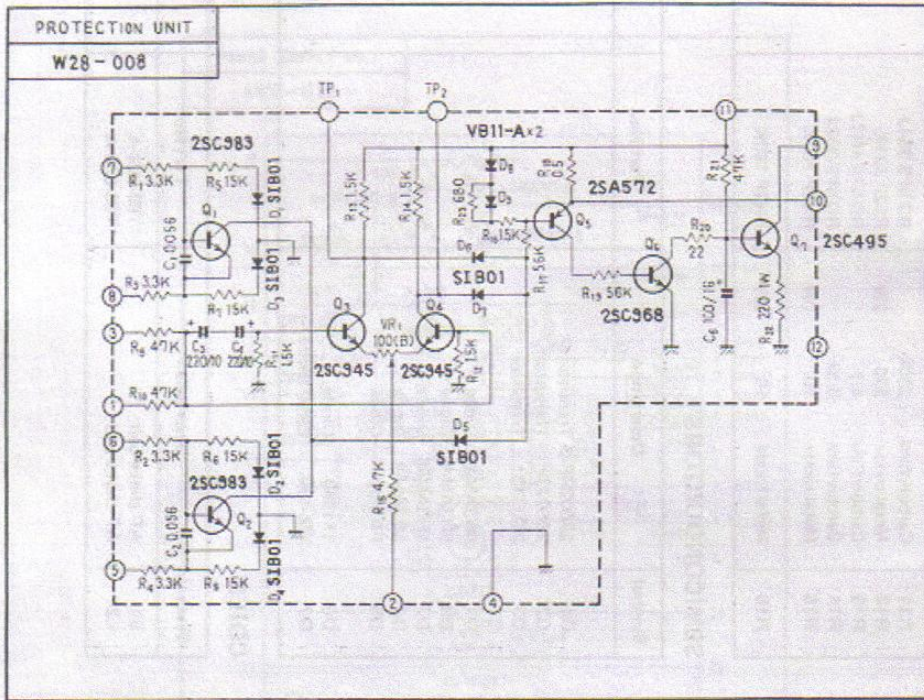

PARTS LIST OF PROTECTION UNIT

CAPACITORS

Symbol	Description	Part No.
C1	Mylar 0.056 50V	CGMA 563K 50
C2	Mylar 0.056 50V	CGMA 563K 50
C3	Electrolytic 220 10V	CEA 221P 10
C4	Electrolytic 220 10V	CEA 221P 10
C5	Electrolytic 100 16V	CEA 101P 16

RESISTORS

Symbol	Description	Part No.
VR1	Semi-fixed, 100-B	C92-063-0
R1	Carbon film 3.3k	RD4PS 332J
R2	Carbon film 3.3k	RD4PS 332J
R3	Carbon film 3.3k	RD4PS 332J
R4	Carbon film 3.3k	RD4PS 332J
R5	Carbon film 15k	RD4PS 153J
R6	Carbon film 15k	RD4PS 153J
R7	Carbon film 15k	RD4PS 153J
R8	Carbon film 15k	RD4PS 153J
R9	Carbon film 47k	RD4PS 473J
R10	Carbon film 47k	RD4PS 473J
R11	Carbon film 1.5k	RD4PS 152J
R12	Carbon film 1.5k	RD4PS 152J
R13	Carbon film 1.5k	RD4PS 152J
R14	Carbon film 1.5k	RD4PS 152J
R15	Carbon film 4.7k	RD4PS 472J

Symbol	Description	Part No.
R16	Carbon film 1.5k	RD4PS 152J
R17	Carbon film 5.6k	RD4PS 562J
R18	Metal oxide 0.5	RS2P 0R5K
R19	Carbon film 56k	RD4PS 563J
R20	Carbon film 22	RD4PS 220J
R21	Carbon film 47k	RD4PS 473J
R22	Metal oxide 220	RS1P 221K
R23	Carbon film 680	RD4PS 681J

SEMICONDUCTORS

Symbol	Description	Part No.
Q1	2SC983-O or Y Transistor	
Q2	2SC983-O or Y Transistor	
Q3	2SC945-R Transistor	
Q4	2SC945-R Transistor	
Q5	2SA572-4 Transistor	
Q6	2SC968Y-2 or 3 Transistor	
Q7	2SC495P-Y Transistor	
D1	S1B01-005 Diode	
D2	S1B01-005 Diode	
D3	S1B01-005 Diode	
D4	S1B01-005 Diode	
D5	S1B01-005 Diode	
D6	S1B01-005 Diode	
D7	S1B01-005 Diode	
D8	VB11-A Varistor	
D9	VB11-A Varistor	

9.10 SWITCH UNIT (SI-A35013)

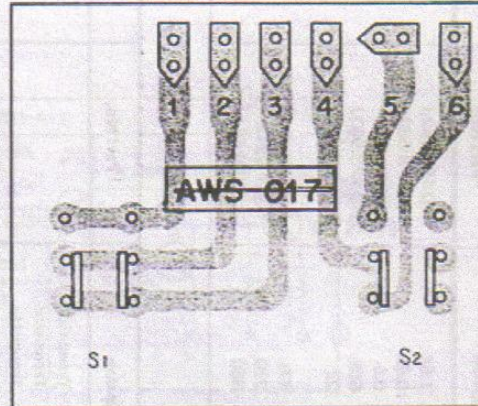
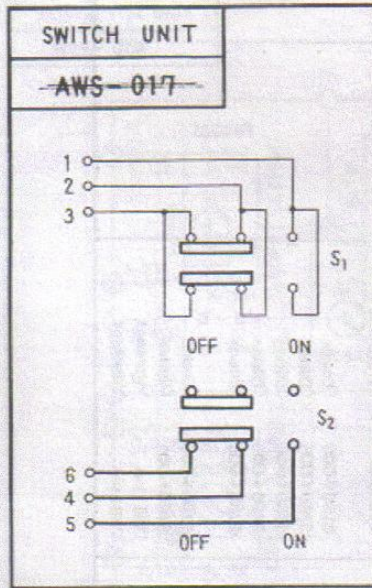

PARTS LIST OF SWITCH UNIT

Symbol	Description	Part No.	
S1	Push switch	ASG-020-0	
S2	Push switch	ASG-020-0	

SX-828

10. PACKING METHOD AND PARTS NUMBERS

