

AM / FM STEREO RECEIVER

# SX-950

OPERATING INSTRUCTIONS

KC  
KU

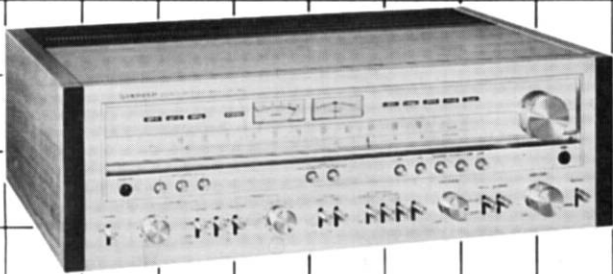

Walnut veneered top and side panels are used in the construction of this cabinet.

WARNING: TO PREVENT FIRE OR SHOCK HAZARD,  
DO NOT EXPOSE THIS APPLIANCE TO RAIN OR  
MOISTURE.

 PIONEER®

## CONTENTS

Stereo System Composition . . . . . 2	Tape Deck Operation . . . . . 12
SX-950 Features . . . . . 3	Adaptor Jacks for Increased Versatility . . . . 14
Connection Diagram . . . . . 4	Employing PRE OUT and POWER IN Jacks . . . . . 16
Connections . . . . . 6	Conditions Frequently Mistaken for Malfunction . . . . . 17
Antenna and Ground Connections . . . . . 7	Specifications . . . . . 18
Front Panel Facilities . . . . . 8	
How to Operate the Receiver . . . . . 10	

## STEREO SYSTEM COMPOSITION

### Tape Deck

- Be sure to install reel clamps when using vertically.
- Always keep heads clean.
- Do not neglect recorded tape for long periods.
- Avoid magnetic fields.

### Turntable

- Protect from vibrations and close dust cover whenever possible.
- Store records vertically and protect from dust and dirt.

Thick curtain shuts out direct sunlight.

SX-950 (Keep connecting cords as short as possible.)

Furniture materials can improve tone.



### Speaker System

Rear and side panels of left and right speakers should have the same surroundings. (Placing with rear panel against a wall improves bass)  
Install speakers so that vibrations are not transferred directly to the floor. (Employ stands or concrete blocks with bookshelf type speakers)

### Carpet

Absorbs sound and vibrations  
(Placing in front of speakers is also effective.)

Listening position slightly to the rear of the apex of an equilateral triangle formed with left and right speakers.

- Do not place equipment in locations that are unlevel or subject to vibration.
- Allow for good rear panel ventilation of components; avoid humidity and dust.
- Keep equipment away from radiators or other heat sources.

## SX-950 FEATURES

### LATEST TECHNOLOGY FRONT END

Two dual gate MOS FETs (field effect transistors), RF amplification and a buffer amplifier between the local oscillator and mixer stages exemplify the advanced technology built into the FM front end. Together with carefully selected circuit components, this provides outstanding performance in terms of sensitivity, overload resistance, image rejection and spurious rejection. In all of its specifications, the SX-950 FM tuner section compares favorably with the most respected separate component type tuners.

### HIGH SELECTIVITY IF STAGES

Excellent capture ratio, stable operation and sharp selectivity are assured by three ceramic filters in the IF stages and IC limiters. The filters never need realignment and contribute to high reliability against aging and ambient temperature variations.

### QUADRATURE DETECTOR AND PLL MPX DEMODULATOR

A balanced bridge differential amplifier performs quadrature detection of the FM signal. Linearity is assured throughout the frequency band, while distortion becomes minimized. Clear and stable separation is provided by the PLL (phase locked loop) multiplex circuit design.

### REDUCED DISTORTION AM CIRCUIT

Careful engineering is also evident in the AM tuner circuit. Automatic gain control in the RF and IF stages, together with a 3-gang variable capacitor and IC circuitry deliver improved image ratio, selectivity and frequency response, plus reduced distortion.

### HEAVY DUTY SPLIT POWER SUPPLY

The dual positive and negative power supply incorporates extra large 22,000  $\mu$ F electrolytic capacitors and possesses plenty of reserve power. Protection and muting functions are included to both safeguard equipment and eliminate power on-off noise.

### PRECISION RIAA PHONO EQUALIZER

Deviation from the RIAA standard is performed within  $\pm 0.3$ dB, while the ability of the phono inputs to accept relatively strong signal levels without distortion (200 mV rms) results in a wide dynamic range.

### HIGH RELIABILITY PROTECTION CIRCUIT

In the event of malfunction, valuable semiconductors and speakers are protected by a relay electronic protection circuit that detects DC output voltage or impedance overload. This circuit also functions to reduce noise during ON-OFF operation of the power supply.

### VERSATILE TONE CONTROLS PLUS TURN-OVER SELECTORS

Active NFB type bass and treble control circuits provide precise and stable control without affecting the mid-range. Turnover frequency selector switches determine the points at which the tone controls take effect, and a convenient tone on-off switch is also employed to allow a flat frequency response to be obtained at any time regardless of tone control and turnover switch settings. This is useful for checking the effects of the phono cartridge, speakers, listening room acoustics, etc. on the spaciousness of the sound.

### DIRECT COUPLED POWER AMPLIFIER

The power amplifier of the SX-950, is a direct-coupled, pure complementary parallel push pull circuit, which uses a differential amplifier at first stage. SX-950 delivers Continuous power output of 85watts\* per channel, min., at 8ohms from 20Hertz to 20,000 Hertz with no more than 0.1% total harmonic distortion.

Plenty of power is available for rich and stable stereo reproduction.

### IMPORTANT ADDITIONAL FEATURES

**Two tape monitor circuits** allow two stereo tape decks to be used for recording, playback and tape duplication.

**Microphone input** on the front panel adds to versatility and enjoyment.

**The audio muting switch** can be used to temporarily reduce the volume by 20dB when changing records or tapes or for other reasons, without continually adjusting the volume control.

**Indicator lamps** provide clear indication of operating mode.

### TASTEFUL STYLING COMPLEMENTS HIGH PERFORMANCE

The exquisitely designed aluminum front panel is trimmed with solid walnut. Control functions and layout also add to both versatility and top grade components appearance. In combination with high quality source components and speaker systems, a magnificent stereophonic music system is composed for providing rich audio enjoyment.

*\*Measured pursuant to Federal Trade Commission's Trade Regulation rule on Power Output Claims for Amplifiers.*

# CONNECTION DIAGRAM

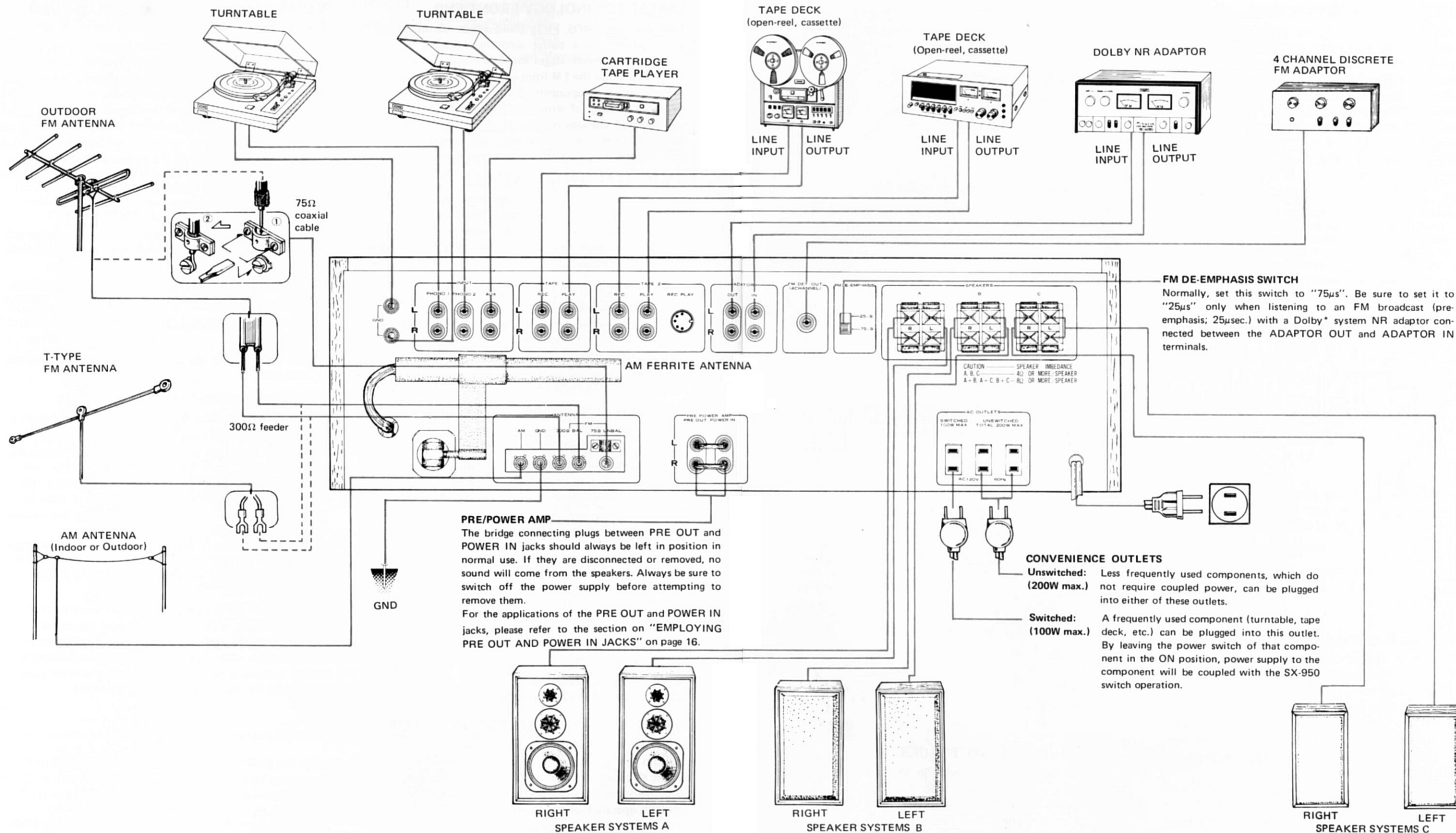

**FM DE-EMPHASIS SWITCH**  
Normally, set this switch to "75μs". Be sure to set it to "25μs" only when listening to an FM broadcast (pre-emphasis; 25μsec.) with a Dolby\* system NR adaptor connected between the ADAPTOR OUT and ADAPTOR IN terminals.

**PRE/POWER AMP**  
The bridge connecting plugs between PRE OUT and POWER IN jacks should always be left in position in normal use. If they are disconnected or removed, no sound will come from the speakers. Always be sure to switch off the power supply before attempting to remove them.  
For the applications of the PRE OUT and POWER IN jacks, please refer to the section on "EMPLOYING PRE OUT AND POWER IN JACKS" on page 16.

**CONVENIENCE OUTLETS**  
**Unswitched: (200W max.)** Less frequently used components, which do not require coupled power, can be plugged into either of these outlets.  
**Switched: (100W max.)** A frequently used component (turntable, tape deck, etc.) can be plugged into this outlet. By leaving the power switch of that component in the ON position, power supply to the component will be coupled with the SX-950 switch operation.

\*The word "Dolby" is a trademark of Dolby Laboratories Inc.

# CONNECTIONS

## SPEAKER SYSTEM CONNECTION

The receiver is equipped with three sets of speaker terminals (A, B, and C). Use the A terminals for the speakers in normal use.

As shown in Fig. 1, the upper socket (red) is the positive (+) terminal, and the lower (black) is the negative (-) terminal in each case.

In the same way, the speakers have positive and negative polarity (+ and - terminals). Be sure to connect terminals of the same polarity together (+ to +, and - to -).

### NOTE:

When two sets of speaker systems are being used at the same time (A + B, A + C, or B + C), please ensure that the impedance of each speaker system is not less than 8Ω. If speaker systems with impedances below 8Ω are used, the receiver's protection circuit may operate to prevent sound being produced.

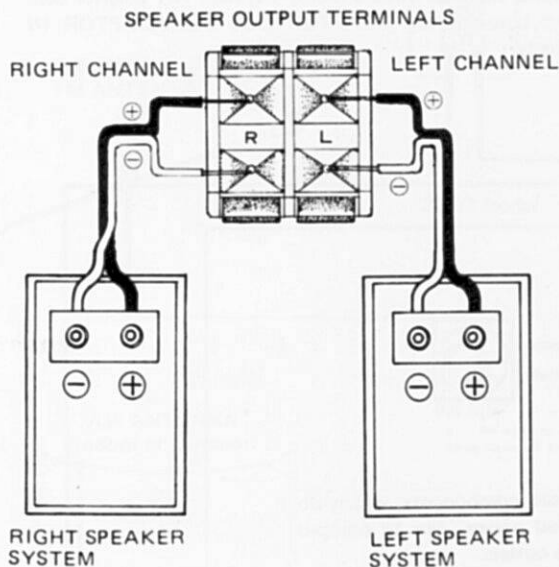

Fig. 1

## Speaker Lead Wire Preparation & Connection (Fig. 2)

1. Strip about 10mm (3/8 inch) of the insulation from the end of the speaker lead wire.
2. If the conductor is stranded, twist the strands together so they do not come loose.
3. Depress the black colored lever of the speaker terminal and insert the speaker minus lead wire into the hole above the lever. Return the lever to its former position.
4. Push up the red colored lever of the speaker terminal and insert the speaker plus lead wire into the hole below the lever. Return the lever to its former position.

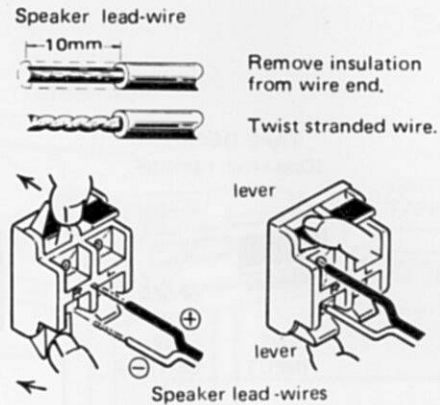

Fig. 2

## TURNTABLE CONNECTIONS

The receiver is fitted with two sets of input jacks, PHONO 1 and PHONO 2, enabling two turntables fitted with magnetic phono cartridges to be connected.

- Connections between the turntable OUTPUT terminals and the receiver PHONO input jacks should be made as shown in Fig. 3, taking care not to confuse L & R channels. If, as in Fig. 3, the turntable is fitted with a ground lead or plug, this should be connected to the receiver GND terminal.

### NOTES:

1. When using a turntable fitted with two tonearms, the output leads for each of the tonearms should be connected to the respective PHONO input jacks (1 and 2).
2. When using a turntable fitted with a moving coil (MC) phono cartridge, it is essential to use a special MC matching transformer or head amplifier.

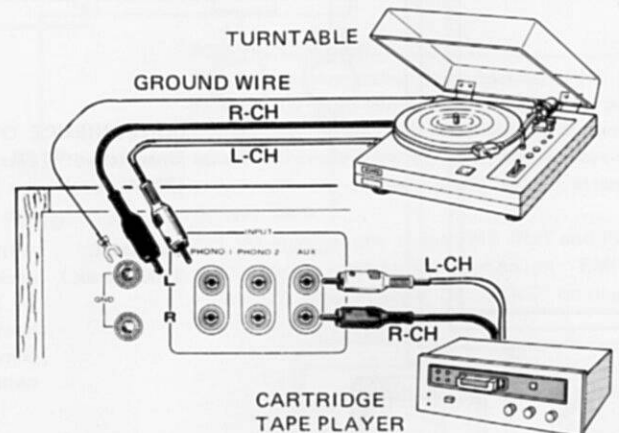

Fig. 3

## USE OF THE AUX INPUT JACKS

These are a set of spare input jacks, which can be connected to a cartridge tape player, television sound tuner, or other signal source. The upper of the two jacks is the L (left) channel, and the lower is the R (right) channel (Fig. 3).

# ANTENNA AND GROUND CONNECTIONS

## FM ANTENNA CONNECTIONS

For the best results you should use an outdoor-type FM antenna, although the simple T-type antenna supplied with the receiver may be used satisfactorily in areas of high signal strength (for instance, those very near to the FM station, or in a house of all-wooden construction).

### FM Outdoor Antenna

Normally, install antenna as follows.

- Connect antenna feeder wire to the 300Ω antenna terminals of the SX-950 as shown in Fig. 4.
- While listening to broadcasts, as described on page 10, install the antenna and determine the best location for optimum reception. Secure antenna firmly.

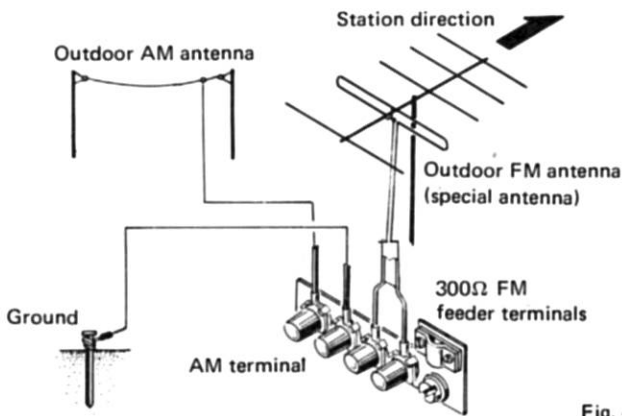
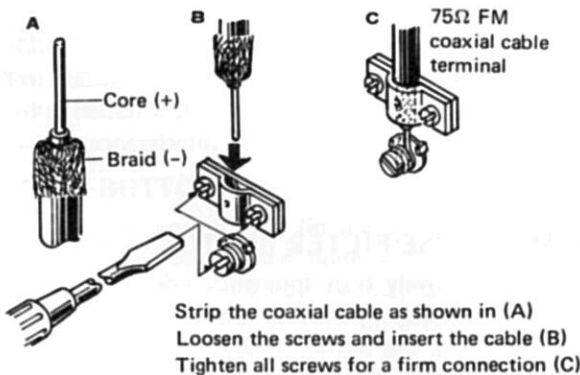

Fig. 4

**NOTE:**

Urban areas with heavy traffic, industrial zones, or locations near high voltage power lines may experience interference even with a special FM antenna. In such cases seek the advice of an audio dealer. It may be advisable to employ 75Ω coaxial cable to connect the antenna to the SX-950 75Ω UNBAL terminal.



Strip the coaxial cable as shown in (A)  
Loosen the screws and insert the cable (B)  
Tighten all screws for a firm connection (C)

Fig. 5

## T-type Antenna

The accompanying T-type antenna can be used where FM signals are strong. Connect it to the antenna terminals as shown in Fig. 6. While listening to an FM station, spread the two arms horizontally and determine its best orientation. Secure it to a wall or ceiling. See FM Reception on page 10.

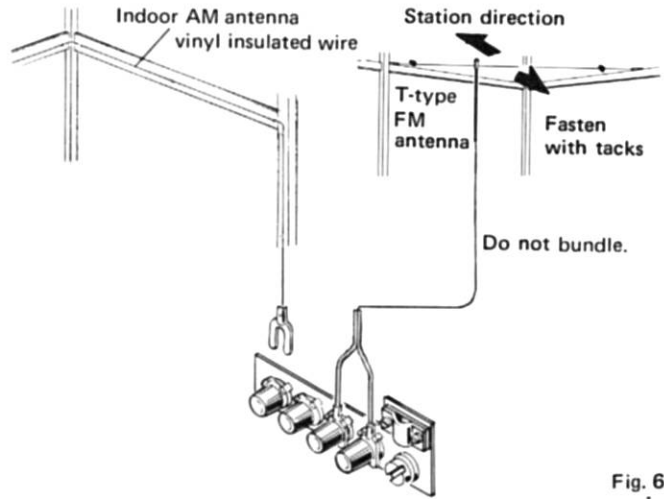

Fig. 6

## AM ANTENNA

Normally, position the ferrite bar antenna (Fig. 7) for best reception while listening to an AM station as described on page 10.

### AM Indoor Antenna

If reception is difficult with the bar antenna, an indoor AM antenna can be erected with vinyl insulated wire as shown in Fig. 6.

### AM Outdoor Antenna

For optimum AM reception, an outdoor AM antenna using vinyl insulated wire can be erected as shown in Fig. 4.

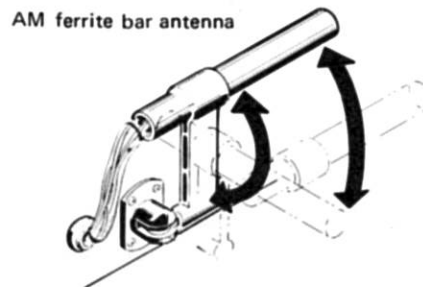

Fig. 7

## GROUND

For maximum safety and to eliminate noise, connect the GND terminal to an earth ground if at all possible. See Fig. 4.

# FRONT PANEL FACILITIES

## SPEAKER BUTTONS

Three sets of speaker terminals, A, B, and C, are provided on the rear panel, and the required speaker systems can be selected by depressing the SPEAKERS buttons as follows:

- A . . . . . Speaker systems A operate
- B . . . . . Speaker systems B operate
- C . . . . . Speaker systems C operate

### NOTES:

1. When any two buttons (A+B, B+C, C+A) are depressed simultaneously, the corresponding pairs of speaker systems will come into operation. However, it is not possible to operate all three speaker systems at the same time, even though all the buttons are depressed.
2. For private listening through headphones, return all the SPEAKERS buttons to the OFF (undepressed) position.

## PHONES OUTPUT JACK

Accepts stereo headphones.

## POWER SWITCH

After turning this switch ON there is a delay of some 3 to 6 seconds, during which time the protection circuit operates to eliminate unpleasant noise.

## BASS CONTROL

Clockwise rotation gives stronger emphasis to the bass range below the turnover frequency (which is selected by the BASS TURNOVER switch), while counterclockwise rotation reduces bass response.

## BASS TURNOVER SWITCH

This selects the frequency below which the bass tone control will begin to act. This "turnover" frequency can be set at 400Hz or 200Hz, to match the characteristics of the room, the program material, or your personal listening preferences.

## TONE SWITCH

In the OFF (up) position, this switch causes the amplifier section to operate with a flat frequency response regardless of the tone control setting.

## TREBLE TURNOVER SWITCH

This switch selects the frequency above which the treble tone control will begin to act. This "turnover" frequency can be set at 2.5kHz or 5kHz, to match the characteristics of the room, the program material, or your personal listening preferences.

## TREBLE CONTROL

Clockwise rotation gives stronger emphasis to the high range above the turnover frequency (selected by the TREBLE TURNOVER switch), while counterclockwise rotation reduces high-range response.

## FM TUNING METER

With the SIGNAL meter needle deflected to the right, make fine adjustment by centering the FM TUNING meter needle (indicating optimum reception).

## SIGNAL METER

For AM and FM station tuning.  
**AM tuning:** Tune for maximum deflection of the SIGNAL meter needle to the right.  
**FM tuning:** Both the SIGNAL and FM TUNING meters work together. (see FM TUNING METER)

## SPEAKER SYSTEM INDICATOR

## FM STEREO INDICATOR

## TUNING KNOB

Select the station and tune for optimum reception by observing the SIGNAL meter for AM stations, and both SIGNAL and TUNING meters for FM stations.

## PROGRAM SOURCE INDICATOR

## FUNCTION SELECTOR BUTTONS

To select the program source, push the buttons as follows:  
**AM . . . . .** For AM broadcast reception.  
**FM . . . . .** For FM broadcast reception. The STEREO indicator lights up when the broadcast is in stereo.  
**PHONO 1 . . . . .** To operate a turntable connected to the PHONO 1 input jacks.  
**PHONO 2/MIC . . . . .** As above for PHONO 2 jacks, or for reproduction through a microphone connected to the MIC jack on the front panel. Note: when the microphone is plugged in the turntable connected to the PHONO 2 jacks cannot be used.  
**AUX . . . . .** For listening to an audio component (cartridge tape player, TV sound tuner, etc.) connected to the AUX input jacks.

*NOTE: Only one FUNCTION button should be depressed at a time.*

## MIC JACK

Accepts a standard 6  $\phi$ mm microphone plug.

## AUDIO MUTING SWITCH - 20dB

Set to -20dB to attenuate the audio output by 20dB. This convenient feature saves having to disturb the VOLUME control, for example when answering the telephone.

## VOLUME CONTROL

Governs the level of sound outputs both from the speaker systems and from headphones.

## LOUDNESS SWITCH

Set to ON when listening at low volume. The frequency response of the human ear varies according to the listening volume, and the ON position compensates for hearing response by emphasizing the bass and treble.

## MODE SWITCH

Set to STEREO for normal stereo operation. When set to MONO, left and right channel signals will be mixed and reproduced monophonically from both speaker systems.

## BALANCE CONTROL

Adjusts the balance between the sound volume from the left and right speaker systems or headphones.

## ADAPTOR SWITCH

When employing adaptor components, such as a graphic equalizer adaptor, RG processor, or Dolby NR adaptor, depress this ADAPTOR switch to ON.

## LOW CUT FILTER SWITCH

When low-pitched rumble (from turntable motor or other source) is obtrusive, set this switch to the 30Hz position to provide 6dB/octave attenuation at frequencies below 30Hz. If no interference is experienced, set in the up position.

## HIGH CUT FILTER SWITCH

When high frequency scratch noise (from worn records or other source) is unpleasant, set this switch to the 6kHz position to provide 6dB/octave attenuation at frequencies above 6kHz. If there is no interference, set in the up position.

## MPX NOISE FILTER BUTTON

Comparatively high frequency noise, incurred when receiving weak FM stereo signals, can be eliminated by depressing this button to ON. In this case however, there will be some loss of stereo separation.

## TAPE MONITOR (1, 2) SWITCHES

- 1 . . . . . With a tape deck connected to the TAPE 1 jacks (REC and PLAY), either playback or monitoring of a recording in progress are possible.
- 2 . . . . . Same as in 1 above, with a tape deck connected to the TAPE 2 jacks (REC and PLAY).

## TAPE DUPLICATE SWITCH

Set this switch in the ON (down) position to duplicate or edit a recorded tape using two tape decks.

## FM MUTING BUTTON

Leave this button undepressed (in the ON position) to suppress unpleasant interstation noise while tuning between stations. Low-strength signals may also be suppressed by this function, so to pick up a weak station depress this button to the OFF position.

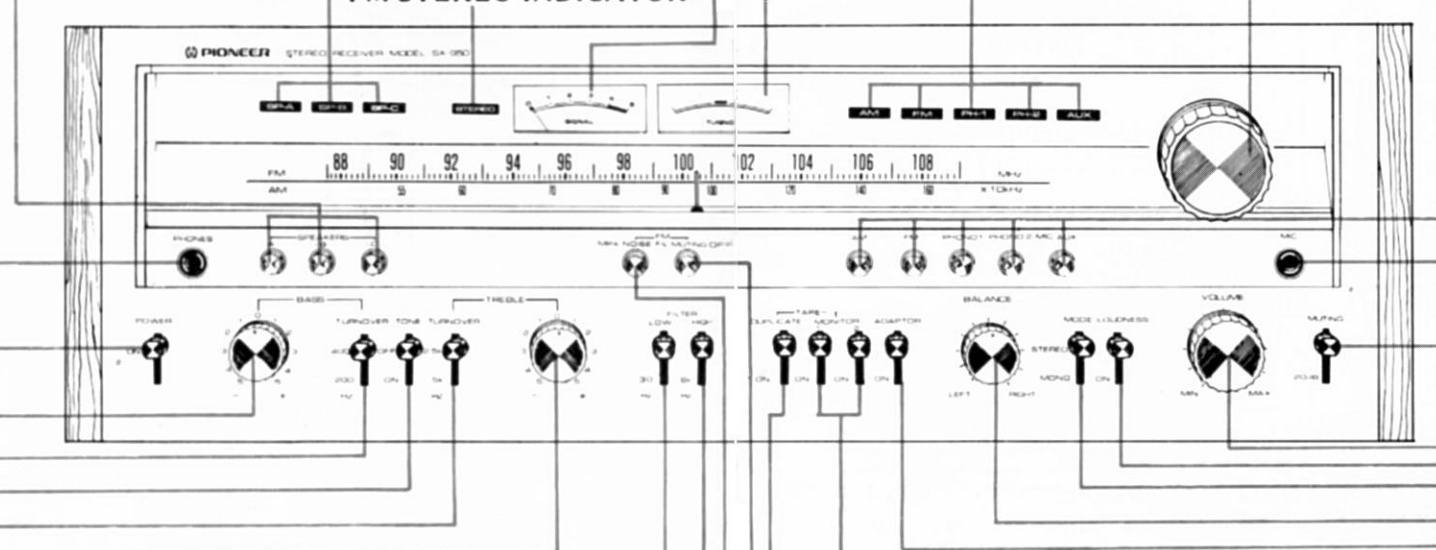

# HOW TO OPERATE THE RECEIVER

## PRIOR TO SWITCHING POWER ON

Before switching on the power, set the various controls as follows:

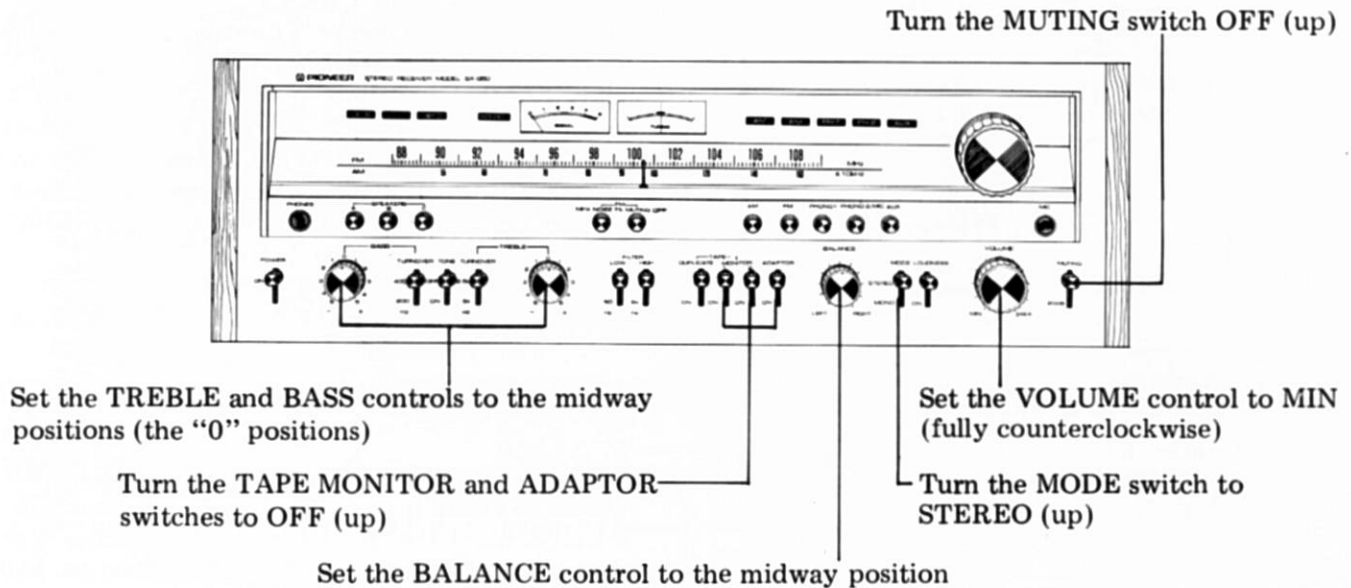

## FM RECEPTION

1. Depress the FM selector button.
2. Set the FM MUTING OFF button to ON (undepressed). Note, however, that in areas of low signal strength the signal may be suppressed. In this case only, the FM MUTING OFF should be depressed.
3. Select the station by means of the TUNING knob.

Best reception is obtained when the SIGNAL meter needle deflects to the extreme right, and the TUNING meter needle is exactly in the center, as shown in Fig. 8. If the broadcast is stereophonic, the STEREO indicator lamp will come on; it will not illuminate for monophonic broadcasts.

4. Adjust the sound level by means of the VOLUME control, and use the BASS and TREBLE controls to give the required tone quality.

## AM RECEPTION

1. Depress the AM selector button.
2. Turn the TUNING knob to select your station. Best reception is obtained when the SIGNAL meter needle deflects to the extreme right (Fig. 9).
3. Adjust the VOLUME, BASS and TREBLE controls for the listening level and tone quality of your preference.

### NOTE:

If, when listening to either FM or AM broadcasts, listening pleasure is seriously affected by poor sensitivity or strong interference, refer to the section "ANTENNA AND GROUND CONNECTIONS," on page 7 and make any necessary changes.



FM Reception

Fig. 8

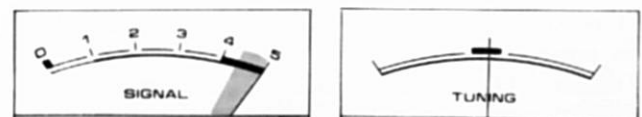

AM Reception

Fig. 9



### RECORD PLAYING

1. Set the FUNCTION selector to either PHONO 1 or PHONO 2/MIC, depending upon which input jacks the turntable is connected to.
2. Operate the turntable to play the record.
3. Adjust the VOLUME, BASS, and TREBLE controls for the listening level and tone quality of your preference.

**NOTE:**

*In order to eliminate the unpleasant noise which can mark the start of a record, set the AUDIO MUTING switch to -20dB, releasing it after the stylus has completed the run-in, and then adjust the VOLUME to give the sound level of your choice.*

### USING THE AUX JACKS

To play equipment connected to the AUX jacks, proceed as follows:

1. Set the FUNCTION selector by depressing the AUX button.
2. Operate the attached component.
3. Adjust the VOLUME, BASS, and TREBLE controls for the listening level and tone quality of your preference.

### MICROPHONE

1. Connect the microphone to the MIC jack.
2. Set the FUNCTION selector by depressing the PHONO 2/MIC button.
3. Adjust the sound level by turning the VOLUME control gradually to the right. The midway setting of the BASS and TREBLE controls will usually give best results.

### PROTECTION CIRCUIT

For some 3 to 6 seconds after the receiver is switched ON, no sound will be heard. This is due to the operation of protection circuits which are designed to safeguard transistors and speakers from possible damage, due chiefly to switching transients, etc. Should the receiver remain silent for considerably longer than this, switch off and check the speaker system connections. Should the receiver suddenly go silent while you are listening to it, and a continuous series of "clicks" can be heard due to relay contacts opening and closing within the receiver, this can be an indication of a short circuit in the speaker system connections. Switch off, and re-check the speaker system impedances, etc.

The protection circuit re-sets itself automatically, so that normal operation is resumed as soon as the fault is cured.

**NOTE:**

*Under certain conditions the microphone is liable to give rise to "howling" or feedback noise. Be careful not to raise the volume too high when the microphone is close to the speaker systems or in a room with a great deal of resonance. This tendency can be reduced by setting the TREBLE and BASS controls to their "0" positions, or by switching the TONE switch OFF (up).*

### TURNOVER SWITCHES

The SX-950 provides two special bass and treble turnover frequency selector switches. Each switch and two numbers, the BASS 400 and 200Hz, the TREBLE 2.5k and 5k, which show the frequencies at which the BASS and TREBLE controls begin to act.

Fig. 10 shows the response curves indicating the relation between the TURNOVER switches and the TREBLE controls.

These are a very convenient way of adjusting the tone quality to suit the characteristics of the room, the program source, the cartridge characteristics or your personal taste, etc.

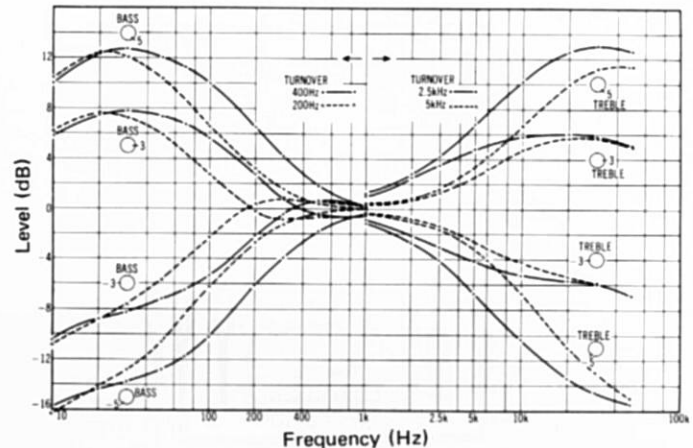

Fig. 10

# TAPE DECK OPERATION

## TAPE DECK CONNECTIONS

Two sets of recording output jacks (TAPE 1, 2 REC) and two sets of playback input jacks (TAPE 1, 2 PLAY) are provided, plus a DIN-type recording/playback connector (TAPE 2 REC/PLAY).

This means that in addition to normal recording and playback, two decks can be used to record at the same time, or to "dub" or duplicate recordings from one tape deck to the other.

Use the connecting cord(s) provided with the tape deck(s) to make the connections (see Fig. 11).

A tape deck can also be connected to the ADAPTOR jacks.

### Connections for Recording

- The receiver output TAPE 1 REC jacks are connected to the recording input jacks (LINE INPUT) of the tape deck as shown in Fig. 11. The upper jack of each pair is the L (left) channel and the lower is the R (right) channel. When the tape deck is provided with a DIN-type connector for recording and playback, use an optional recording/playback cord (Fig. 12).

**NOTE:**

As the recording/playback cord connects both recording and playback functions at the same time, there is no need to make separate connections to either TAPE 2 REC output jacks or TAPE 2 PLAY input jacks. If the ADAPTOR OUT jacks are to be used, connect them to the tape deck input (LINE INPUT) jacks.

- When using two tape decks, the second tape deck should be connected to the receiver TAPE 2 REC output jacks. If, however, the first deck has been connected to the DIN-type recording/playback connector, the second deck should be connected to the TAPE 1 REC output jacks.

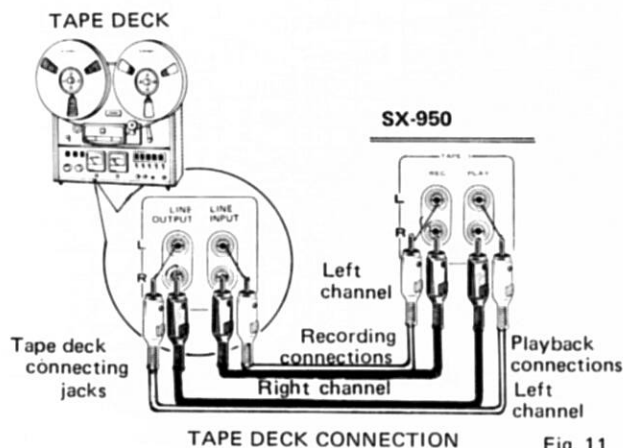

Fig. 11

### Connections for Playback

- Connect the receiver TAPE 1 PLAY input jacks to the playback output jacks (LINE OUTPUT or TAPE MONITOR) on the tape deck. The upper jack of each pair is the L (left) channel, and the lower is the R (right) channel.

**NOTE:**

If the ADAPTOR IN jacks are to be used, connect them to the tape deck output (LINE OUTPUT) jacks.

- When using two tape decks, the second tape deck should be connected to the receiver TAPE 2 PLAY input jacks. If, however, the first deck has been connected to the DIN-type recording/playback connector (TAPE 2 REC/PLAY), the second deck should be connected to the TAPE 1 PLAY input jacks.

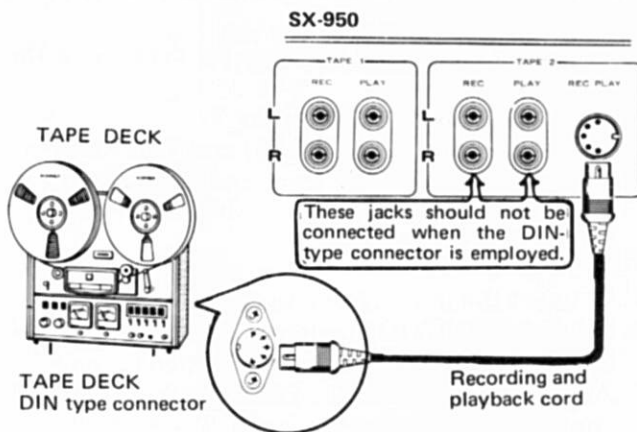

Fig. 12

## OPERATIONS

### Playback

1. According to the TAPE PLAY (1, 2) or ADAPTOR IN jacks to which the tape deck is connected, either the TAPE MONITOR 1 or 2 switches or the ADAPTOR switches should be set to ON (see Figs. 13 and 14).
2. Operate the tape deck controls for playback.
3. Adjust the VOLUME, BASS, and TREBLE controls for the listening level and tone quality of your preference.

**NOTE:**

Setting the TAPE MONITOR switch to ON enables tape playback whatever the setting of the FUNCTION selector.



Fig. 13

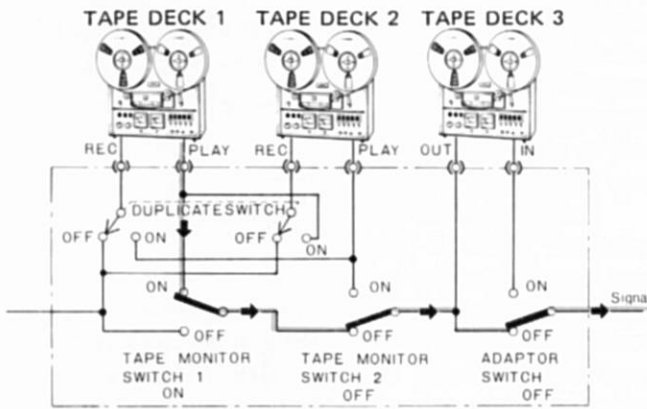

Fig. 14

**Recording**

As shown in Fig. 15, the receiver TAPE REC (1, 2) and ADAPTOR OUT jacks carry a certain fixed level output from the source selected by the FUNCTION selector, which once the tape deck is connected to the appropriate jacks, enables the selected source to be recorded.

The operation is as follows:

1. Set the FUNCTION selector button for the source to be recorded.
2. Play the selected program source.
3. Adjust the recording level by means of the controls on the tape deck and commence recording.

**NOTE:**

The receiver VOLUME, BASS, and TREBLE controls are completely inoperative — that is they have no affect on the recorded sound — when recordings are being made.

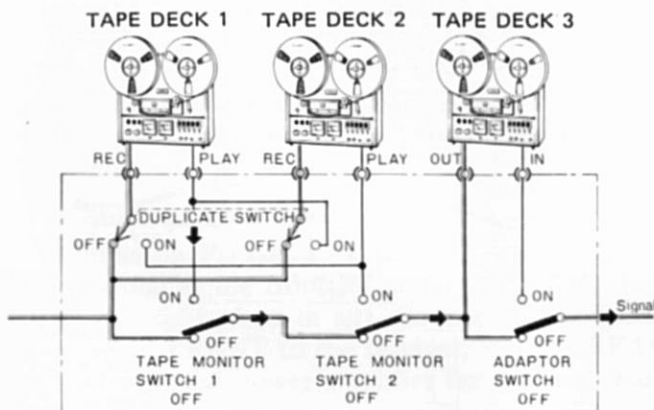

Fig. 15

**Tape Monitoring**

While a recording is being made on a three-head deck or one equipped with a monitoring facility, the recorded sound can be monitored through the speaker systems if the TAPE MONITOR switch is turned ON.

In this case both recording and playback connections must be made.

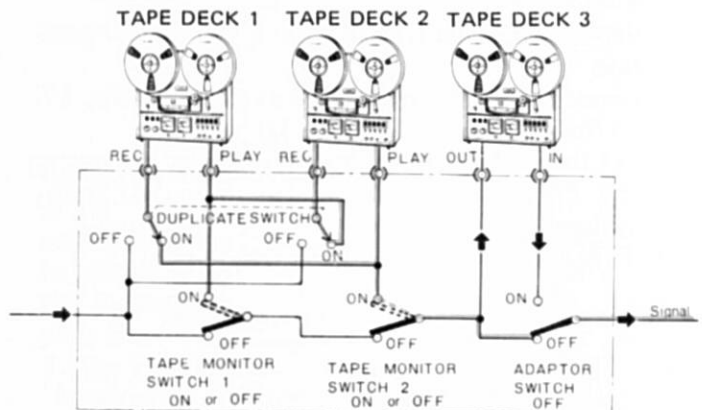

Fig. 16

**Duplicating or Editing Recorded Tapes**

By using two tape decks, a recording of, say, a complete FM broadcast can be made, and then those items which you want for your permanent "tape library" can be selected and re-recorded onto another tape.

1. Connect the two tape decks as shown in Fig. 16.
2. Set the TAPE DUPLICATE switch to the ON position.
3. Select one of the tape decks (1 or 2) to playback the pre-recorded tape, and use the other tape deck to make the copy recording.
4. When recording with tape deck 1, TAPE MONITOR switch 1 should be switched ON to monitor the sound being recorded, and when recording with deck 2, TAPE MONITOR switch 2 should be switched ON for monitoring (refer again to Fig. 16).

# ADAPTOR JACKS FOR INCREASED VERSATILITY

## USE OF DOLBY ADAPTOR

If a Dolby adaptor is connected to the receiver ADAPTOR jacks, not only can FM Dolby broadcasts be played back, but if a tape deck is connected to the adaptor itself, Dolby system recording and playback are available.

## RECEPTION OF FM DOLBY BROADCASTS

Dolby system FM broadcasts can be received by making the following connections:

1. Set the DE-EMPHASIS switch to "25 $\mu$ s" position.
2. Connect the Dolby adaptor as shown in Fig. 17. to the ADAPTOR IN and OUT jacks.
3. Set the FUNCTION selector to FM by depressing the FM button, and tune in to an FM Dolby system broadcast.
4. Turn the ADAPTOR switch ON.

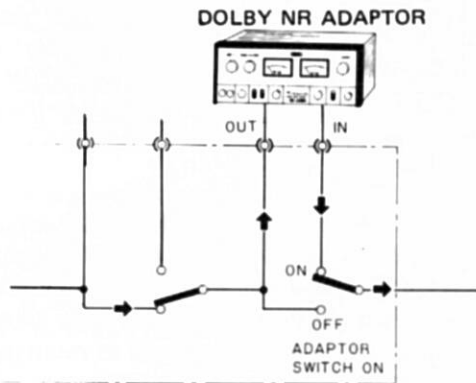

Fig. 17

## Dolby Recording

1. As shown in Fig. 18, connect the Dolby adaptor output jacks to the tape deck recording input jacks (LINE INPUT).
2. Select the program source of your choice with the FUNCTION selector.

### NOTE:

If you wish to monitor the sound being recorded with the Dolby adaptor, turn the ADAPTOR switch ON.

## Dolby Playback

1. Connect the tape deck playback output jacks (LINE OUTPUT) to the input jacks of the Dolby adaptor.
2. Turn the ADAPTOR switch ON, and playback your Dolby system recordings.

### NOTE:

For detailed instructions on connections, etc., please see the instruction manual provided with your Dolby adaptor.

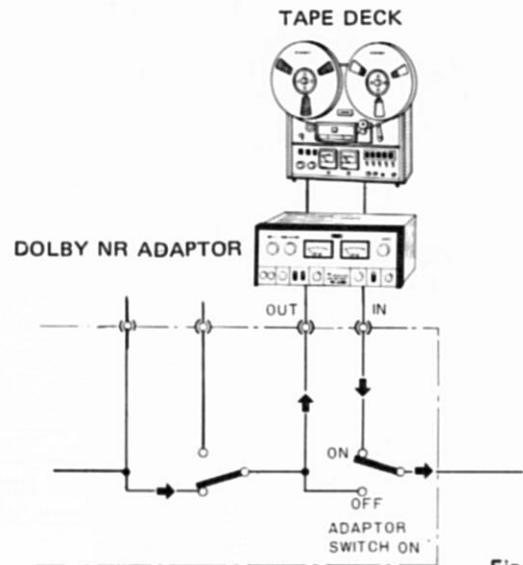

Fig. 18

## OTHER ADAPTORS CURRENTLY AVAILABLE

The provision of these convenient adaptor jacks in addition to the normal tape REC/PLAY jacks, enables other sophisticated adaptor units (e.g. a graphic equalizer, RG dynamic processor, etc.) to be connected without forfeiting the full tape monitoring and duplicating facility. When using an adaptor, the program source can be taken from the function selector or the tape deck output terminals. Fig. 19 illustrates an RG dynamic processor connected to the ADAPTOR terminals.

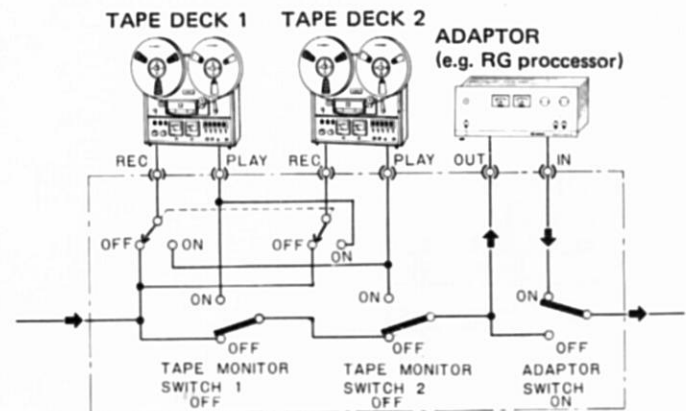

Fig. 19

### SETTING UP A 4-CHANNEL SYSTEM

As shown in Fig. 20, a 4-channel system consists of two pairs of speakers, one at the front and the other at the rear, which gives a whole new dimension of realism not attainable with conventional 2-channel stereo. It gives a truer impression of the acoustics of the hall where the recording was made, including the atmosphere and applause. The unique sense of "presence" of being "actually there" which 4-channel stereo alone can give, has to be experienced before it can be appreciated, and this receiver is ideally suited to form the heart of a 4-channel system, when connected to four speaker systems and a 4-channel decoder/power amplifier ("decoder-amp" below) for the rear channels.

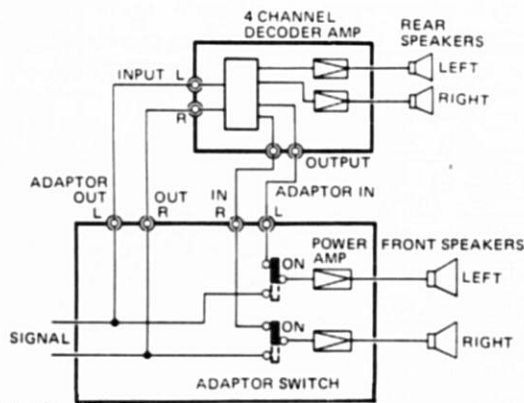

Fig. 20

#### Operation

1. Connect the receiver ADAPTOR OUT jacks to the decoder-amp INPUT jacks.
2. Connect the receiver ADAPTOR IN jacks to the decoder-amp OUTPUT jacks.
3. Turn the ADAPTOR switch ON.
4. Switch on the auxiliary adaptor unit.
5. You are now ready to enjoy the thrill of 4-channel reproduction.

#### Placement of Your Speaker Systems

As shown in Fig. 22, two pairs of speaker systems are located at the front left and right, and the rear left and right (four in all). Connect the speakers located in FRONT to the receiver, and the REAR speakers to the power amplifier for the rear channels.

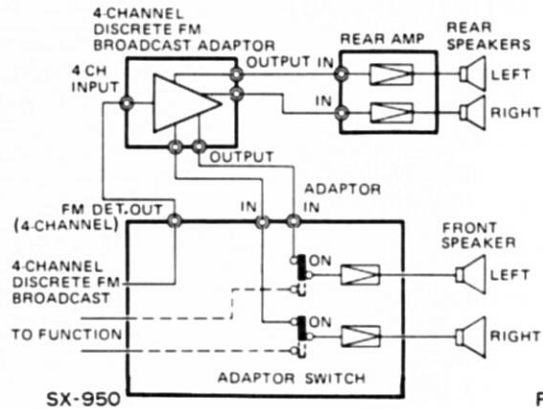

Fig. 21

#### Receiving 4 channel FM broadcasts

If 4-channel multiplex discrete FM broadcasts are available, the addition of a 4-channel discrete FM broadcast adaptor ("adaptor" below) will enable full 4-channel reproduction of the broadcasts from your receiver.

1. The adaptor is connected to the FM DET. OUT jack of the receiver as shown in Fig. 21.
2. Connect the adaptor output to the receiver ADAPTOR IN jacks.
3. Turn the ADAPTOR switch ON.
4. Depress the FM button for FUNCTION selection.
5. Tune in to the 4-channel discrete FM broadcast.
6. Switch on the auxiliary adaptor unit.
7. Adjust the VOLUME, BASS, and TREBLE controls for the listening level and tone quality of your preference.

#### NOTE:

For detailed instructions on connections, etc., see the instruction manual supplied with the adaptor.

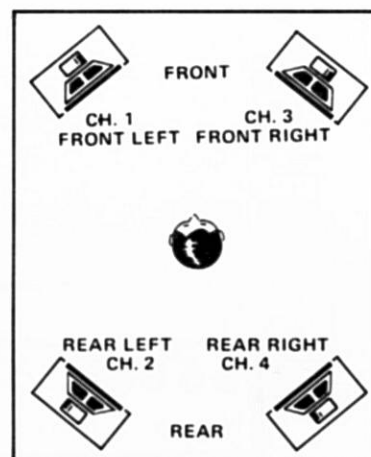

Fig. 22

# EMPLOYING PRE OUT AND POWER IN JACKS

## USING THE PRE OUT AND POWER IN JACKS

If the connections between the PRE OUT and POWER IN jacks shown in Fig. 23 are removed, the power amplifier and pre-amplifier section, it is possible to use it to drive a separate, high output power amplifier, or to build up a multi-amplifier system.

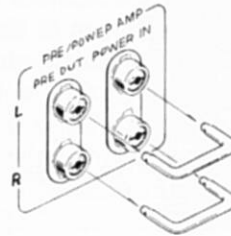

Fig. 23

## INDEPENDENT PREAMPLIFIER FUNCTION

The preamplifier section of the SX-950 can be used independently to drive an external power amplifier. This allows comparison listening between the built-in SX-950 power amplifier and a homebuilt or other separate power amplifier.

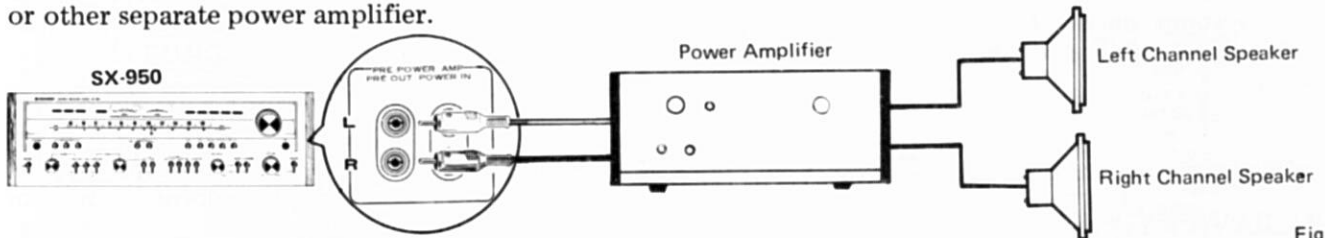

Fig. 24

## CONNECTIONS FOR SETTING UP A MULTI-AMPLIFIER SYSTEM

By purchasing an electronic crossover network and one or two additional power amplifiers, a two- or three-way multi-amplifier system can be constructed. This splits up the audible frequency range into different frequency bands, to operate amplifiers and speakers ideally suited to each band. The result are reduced intermodulation distortion and improved damping and crossover characteristics. Use of the multi-amplifier system is as follows:

1. Remove both of the plugs bridging the PRE OUT and POWER IN jacks.
2. Connect the PRE OUT jacks to the input jacks of the crossover network.

3. Connect the POWER IN jacks to the LOW range jacks of the crossover network.
4. Connect the HIGH range output jacks of the crossover network to the input jacks of a separate power amplifier for the high frequency range.
5. Connect the speakers for the lower frequencies to the receiver, and those for the higher frequencies to the separate amplifier.

The levels of the different frequency ranges are adjustable by the crossover network. For detailed instructions on the use of the crossover network, please refer to the instruction manual provided with it.

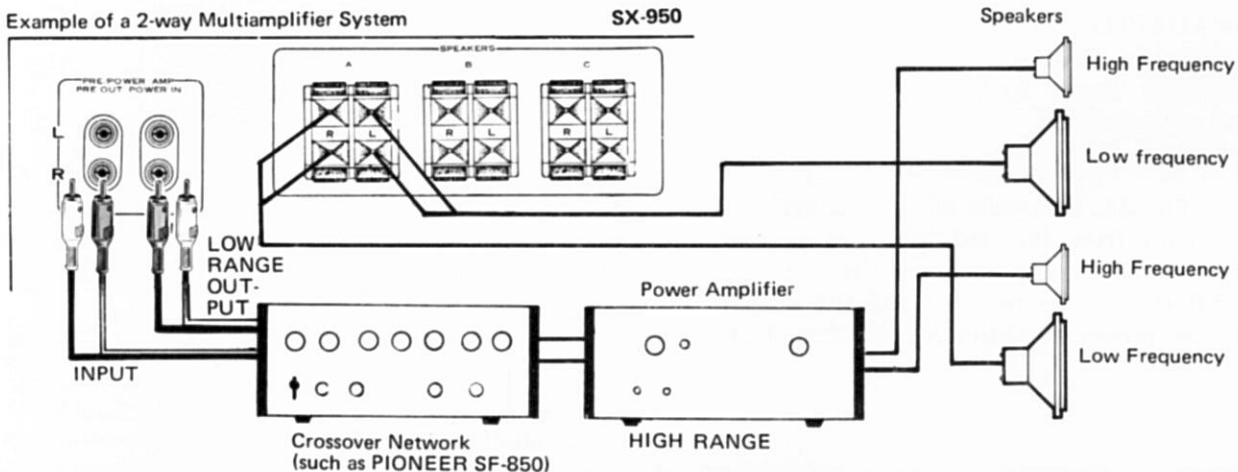

Fig. 25

## CONDITIONS FREQUENTLY MISTAKEN FOR MALFUNCTION

If your stereo appears to malfunction, first check such things as the fuse, controls (power switch, function selector, tape monitor, etc.) and connecting cords (components connected correctly).

Noise: There are a variety of noises relating to the operation of a hi-fi unit. These are generally divided into two types; (1) the unit is faulty (a transistor or part has deteriorated) and (2) an external source is adding to the unit.

When a hi-fi unit produces an unpleasant noise, it is often assumed that the unit is faulty, but statistical records indicate that the majority of noises pro-

duced in hi-fi acoustic units result from external sources of noise: Due to the inherent high sensitivity and the high fidelity in reproduction, the unit amplifies and reproduces extraneous noises, however small, into definite output noise. If your receiver produces a noise, check according to the following table and trace out the source of noise for the appropriate corrective action.

	SYMPTOM	SUSPECTED SOURCE OF NOISE	DIAGNOSIS AND REMEDY
WHEN LISTENING TO BROADCASTS	Continuous or intermittent noise like jiiiii or zzzzzz.	<ul style="list-style-type: none"> <li>• Static (lightning)</li> <li>• Fluorescent lamp, motor, or thermostat may be in use in house or in the vicinity of the house.</li> </ul>	In many cases, it is very difficult to remove the source of noise. In order to make the radio input larger than the noise level, set up a good outdoor antenna and make a complete grounding.
	When a station is tuned in, hum is mixed in the program.	<ul style="list-style-type: none"> <li>• Poor fluorescent lamp, motor, or electric heater may be in use in house or near the house.</li> </ul>	Reversing the line plug may occasionally alleviate this noise problem. Usually it is very difficult to eliminate the noise.
	Hissing sound noise in AM (medium wave) reception.	<ul style="list-style-type: none"> <li>• The frequency of an adjacent station is interfering with that of the station being tuned in (10kHz beat interference).</li> <li>• TV set is on in the same house with the receiver.</li> </ul>	Impossible to remove such interference. If the cause of such noise is the TV set, increase the distance between the TV set and receiver.
	Static noise (in particular, when automobiles run close to the house).	<ul style="list-style-type: none"> <li>• White noise generated from automobile engines.</li> <li>• High frequency sewing machine or welding machine being used near your house.</li> </ul>	In an area surrounded by hills or high buildings, the FM input signals are very weak. Thus the noise limiter in the circuit loses its function. Set up an FM outdoor antenna having many director elements.
	Reception of FM stereo program contains more noise than FM mono program.	<ul style="list-style-type: none"> <li>• Note that the service area covered by an FM stereo broadcast is about 50% of that of a regular mono broadcast.</li> </ul>	Increasing the FM input signal may alleviate this problem. Use an exclusive FM outdoor antenna instead of the indoor T-type antenna.
WHEN PLAYING RECORDS	Hum or buzz. When switched to radio reception, the noise disappears.	<ul style="list-style-type: none"> <li>• Poor connection of shielded wire. (a)</li> <li>• Jack connection is loose. (b)</li> <li>• Line cord of fluorescent lamp is near the shielded wire. (c)</li> <li>• Poor grounding. (d)</li> <li>• Ham transmitting station or TV transmitting station is near your house. (e)</li> </ul>	Correct the conditions stated in (a), (b), (c) or (d). In case of (e), report it to an official activity.
	Output tone quality is poor and mixed with noise. Treble is not clear.	<ul style="list-style-type: none"> <li>• Stylus is worn. (a)</li> <li>• Record is worn. (b)</li> <li>• Dust adhering to stylus. (c)</li> <li>• Stylus is improperly mounted. (d)</li> <li>• Stylus pressure is not correct. (e)</li> <li>• The TREBLE level is too high.</li> </ul>	Check (a) through (e) and correct the condition.  Lower the TREBLE level.
	In playing a record, increasing the volume causes howling.	<ul style="list-style-type: none"> <li>• Distance between the turntable and the speakers is too short.</li> <li>• The turntable or speakers supports are unstable.</li> </ul>	Increase the distance or rearrange the installation of the unit and speakers. (Installing the turntable on a firm, solid stand may alleviate this problem.) Do not enhance the BASS sound level excessively.
WHEN USING MICROPHONE	Howling occurs	<ul style="list-style-type: none"> <li>• Feed back between microphone and speakers.</li> </ul>	<ul style="list-style-type: none"> <li>• Keep microphone away from speakers</li> <li>• Do not set the VOLUME control too high.</li> <li>• Set BASS and TREBLE controls to center positions.</li> </ul>

# SPECIFICATIONS

## Semiconductors

FETs	4
ICs	4
Transistors	55
Diodes	36

## Power Amplifier Section

Continuous power output of 85watts\* per channel, min., at 8ohms or 110watts\* per channel at 4ohms from 20Hertz to 20,000Hertz with no more than 0.1% total harmonic distortion.

### Total Harmonic Distortion

(20 Hertz to 20,000 Hertz, from AUX)	
Continuous Rated Power Output	No more than 0.1%
43 watts per channel power output, 8 ohms	No more than 0.05%
1 watt per channel power output, 8 ohms	No more than 0.05%

### Intermodulation Distortion

(50 Hertz: 7,000Hertz=4:1, from AUX)	
Continuous Rated Power Output	No more than 0.1%
43 watts per channel power output, 8 ohms	No more than 0.05%
1 watt per channel power output, 8 ohms	No more than 0.05%

Frequency Response . . . . . 7Hz to 90,000Hz  $\pm 1$ dB

### Input Sensitivity/Impedance

POWER AMP IN . . . . . 1 V/50k ohms

### Output

Speaker	A, B, C, A+B, B+C, A+C
Headphone	Low Impedance

### Damping Factor

(20Hz to 20,000Hz, 8 ohms) . . . . . 25

Hum and Noise (IHF, short-circuited, A Network) . . 100dB

## Preamplifier Section

### Input Sensitivity/Impedance

PHONO 1	2.5mV/50k ohms
PHONO 2	2.5mV/50k ohms
MIC	6.5mV/50k ohms
AUX	150mV/50k ohms
TAPE PLAY 1	150mV/50k ohms
TAPE PLAY 2	150mV/50k ohms
TAPE PLAY 2 (DIN connector)	150mV/50k ohms

### PHONO Overload Level (T.H.D. 0.1%)

PHONO 1	200mV (1kHz)
PHONO 2	200mV (1kHz)

### Output Level/Impedance

TAPE REC 1	150mV
TAPE REC 2	150mV

TAPE REC 2 (DIN connector)	30mV/80k ohms
PRE OUT	1V/100 ohms

### Total Harmonic Distortion

(20Hz to 20,000Hz 1V output). . . No more than 0.05%

### Frequency Response

PHONO (RIAA equalization)	30Hz to 15,000Hz $\pm 0.2$ dB
AUX, TAPE PLAY	10Hz to 50,000Hz $\pm 1$ dB

### Tone Control

BASS	$\pm 7$ dB/ $\pm 10$ dB (100Hz)	Turnover Frequency 200Hz/400Hz
TREBLE	$\pm 7$ dB/ $\pm 10$ dB (10kHz)	Turnover Frequency 5kHz/2.5kHz

### Filter

LOW	30Hz (6dB/oct.)
HIGH	6kHz (6dB/oct.)

### Loudness Contour (Volume control set

at -40dB position) . . . . . +6dB (100Hz), +3dB (10kHz)

### Hum and Noise

(IHF, short-circuited, A Network, rated power)	
PHONO	75dB
AUX, TAPE PLAY	90dB

Muting . . . . . -20dB

## FM Section

Usable Sensitivity	MONO	10.3dBf (1.8 $\mu$ V)
	STEREO	22.2 dBf (7.1 $\mu$ V)

### 50dB Quieting Sensitivity

MONO	17.2dBf (4 $\mu$ V)
STEREO	38.0dBf (44 $\mu$ V)

Signal to Noise Ratio at 65dBf	MONO	72dB
	STEREO	67dB

Distortion at 65dBf 100Hz	MONO	0.15%
	STEREO	0.3%
1kHz	MONO	0.15%
	STEREO	0.3%
6kHz	MONO	0.4%
	STEREO	0.4%

Frequency Response . . . . . 30HZ to 15,000Hz  $\pm 0.2$ dB

Capture Ratio . . . . . 1.0dB

Alternate Channel Selectivity . . . . . 80dB

Spurious Response Ratio . . . . . 100dB

Image Response Ratio . . . . . 85dB

IF Response Ratio . . . . . 100dB

AM Suppression Ratio . . . . . 55dB

Muting Threshold . . . . . 14dBf (2.8 $\mu$ V)

Stereo Separation . . .40dB (1kHz), 30dB (30Hz ~ 15kHz)

Subcarrier Product Ratio . . . . . 62dB

SCA Rejection Ratio . . . . . 62dB

Antenna Input	300 ohms balanced
	75 ohms unbalanced



**AM Section**

Sensitivity (IHF, Ferrite antenna)	300 $\mu$ V/m
(IHF, Ext. antenna)	15 $\mu$ V
Selectivity	40dB
Signal to Noise Ratio	55dB
Image Response Ratio	65dB
IF Response Ratio	85dB
Antenna	Built-in Ferrite Loopstick Antenna

**Miscellaneous**

Power Requirements	120V 60Hz
Power Consumption	370W (UL, CSA) 760W (max.)
Dimensions	526.6(W)x173(H)x411.5(D) mm 20-3/4(W)x6-13/16(H)x16-3/16(D) in
Weight	19.1kg (42 lb 3 oz)

**Furnished Parts**

FM T-type Antenna	1
Operating Instructions	1
Hex. Wrench	1

*\* Measured pursuant to Federal Trade Commission's Trade Regulation rule on Power Output Claims for Amplifiers.*

**NOTE:**

*Specifications and the design subject to possible modification without notice due to improvements.*

**HEX WRENCH**

The accessory hex. wrench is provided for removing the TUNING knob or tightening its setscrew in event it becomes loose.

If required, loosen the setscrew by inserting the wrench into the hole on the side of the knob and turning the wrench counterclockwise. Be particularly careful not to scratch the front panel when employing the wrench.



