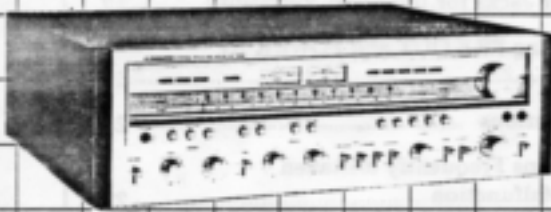


AM/FM STEREO RECEIVER

SX-1250

OPERATING INSTRUCTIONS

KC
KU



Walnut veneered top and side panels are used in the construction of this cabinet.

WARNING: TO PREVENT FIRE OR SHOCK HAZARD,
DO NOT EXPOSE THIS APPLIANCE TO RAIN OR
MOISTURE.

 PIONEER

CONTENTS

Stereo System Composition	2	Microphones	14
SX-1250 Features	3	Effective Operation	15
Connection Diagram	4	Tape Deck Operations	16
Connections	6	Adaptor Jacks for Increased Versatility	17
Antenna and Ground Connections	8	Employing PRE OUT and POWER IN Jacks	19
Front Panel Facilities	10	Specifications	20
Prior to Switching Power On	13	Conditions Frequently Mistaken for Malfunction	22
FM Reception	13	Circuit Diagram	Insertion
AM Reception	13		
Playing Records	14		
Using the AUX Jacks	14		

STEREO SYSTEM COMPOSITION

- The SX-1250 is heavy and should always be handled with great care.
- Do not place equipment in locations that are unlevel or subject to vibration.
- Allow for good rear panel ventilation of components; avoid humidity and dust.
- Keep equipment away from radiators or other heat sources.

Tape Deck

- Be sure to install reel clamps when using vertically.
- Always keep heads clean.
- Do not neglect recorded tape for long periods.
- Avoid magnetic fields.

Turntable

- Protect from vibrations and close dust cover whenever possible.
- Store records vertically and protect from dust and dirt.

Thick curtain shuts out direct sunlight.

SX-1250 (Keep connecting cords as short as possible.)

Listening position slightly to the rear of the apex of an equilateral triangle formed with left and right speakers.

Furniture materials can improve tone.

Speaker System

Rear and side panels of left and right speakers should have the same surroundings. (Placing with rear panel against a wall improves bass) Install speakers so that vibrations are not transferred directly to the floor. (Employ stands or concrete blocks with bookshelf type speakers)

Carpet

Absorbs sound and vibrations (Placing in front of speakers is also effective.)

SX-1250 FEATURES

Clear and Stable FM Tuner Circuit

- The FM front end incorporates a frequency linear 5-gang variable capacitor and 3 dual gate MOS FET devices in the two stage RF and mixer circuits. A buffer amplifier is also included with the local oscillator circuit, leading to advanced specifications in such important factors as sensitivity and spurious rejection. Stable reception can therefore be enjoyed even in strong signal areas.
- Four phase linear ceramic filters plus a 4 IC differential amplifier are employed in the FM IF section to provide excellent phase characteristics, selectivity and capture ratio.
- Outstanding frequency response and separation are achieved by the phase locked loop (PLL) circuit in the FM MPX section. This circuit employs a newly developed IC and is not affected by ambient temperature or aging.
- Beat interference from an adjacent station 200kHz from the desired one is cut by the built-in anti-birdy filter. FM broadcasts become more clearly received.

Linear Dial AM Section

Integrated circuits are employed in all AM circuit stages for sensitive and clear reception. The convenient, easy to interpret linear station dial can be found only on a few receivers for the AM tuner circuit.

Ample Reserve Power Amplifier

Plenty of power to spare is delivered by the power amplifier circuit that includes a differential amplifier 2-stage, Darlington 3-stage and parallel push-pull final stage. All stages are direct coupled in a pure complementary OCL circuit which also contains a current mirror circuit.

Continuous power output is 160 watts* per channel min, RMS at 8 ohms from 20 Hz to 20,000 Hz with no more than 0.1% total harmonic distortion.

In addition to superb frequency response and distortion characteristics, differential amplifier and temperature compensating circuits contribute to stable performance even with variations in external conditions.

Independent Power Supplies in Final Stage of Power Amplifier

Independent power supply circuits, including separate power transformer windings, rectifiers and smoothing capacitors are provided for left and right channels. These improve crosstalk characteristics at low frequencies. Large and stable output power is also promoted by toroidal core transformer and four 22,000 microfarad electrolytic capacitors in the power supply. Rich tone quality becomes assured even at the lowest audio frequencies.

Precision Engineered Equalizer Amplifier

RIAA deviation is suppressed to ± 0.2 dB from 30Hertz to 15,000Hertz. Negative feedback elements combine ultra precision grade nichrome vapor deposited metal film resistors and styrol capacitors. By adopting a differential amplifier and 3-stage SEPP circuit, input impedance variations due to frequency are minimized. Maximum nominal input is also increased (500mV rms) to provide high stability and low distortion. Even with a high output phono cartridge and a music source containing large peak levels, distortionless record performance can be enjoyed.

Delicately Adjustable Tone Controls

A twin tone control circuit, developed by Pioneer, is adopted which combines independently adjustable ultra high and ultra low controls with conventional bass and treble controls. Fine and delicate tone adjustments can be performed according to listening room acoustics, speaker and phono cartridge frequency characteristics, or personal preference. Control effectiveness can be readily determined by the convenient tone defeat switch.

Reliable Protection Circuit

Valuable transistors and speakers are safeguarded against damage in event a circuit or operating malfunction results in speaker shorting or DC potential across the output terminals. Reliability becomes increased by including a relay and electronic protection circuit. Noise produced by ON-OFF operation of the power switch is cut by a special muting circuit, while overcurrent occurring when the power is switched on becomes suppressed by the surge current control circuit.

Important Auxiliary Features

Two tape monitor circuits allow two stereo tape decks to be used for recording, playback and tape-to-tape duplicating.

Microphone input on the front panel allows operation as a public address amplifier.

Filter switches for 30 Hz low cut and 8 kHz high cut possess sharp 12 dB/octave slopes. They can be used for cutting program source defects such as rumble or scratches.

Adaptor jacks allow various types of adaptors to be connected and operated by a front panel switch.

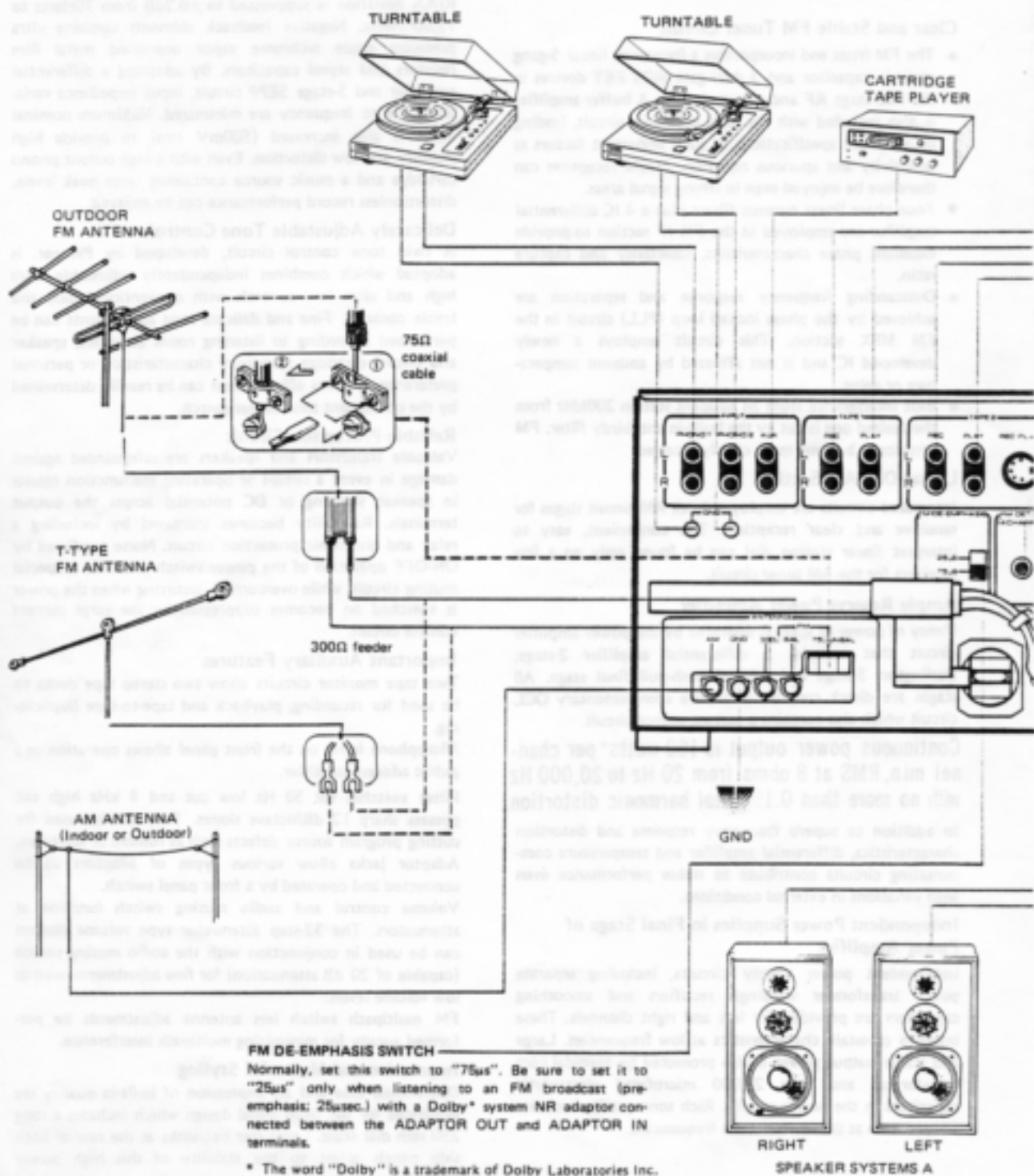
Volume control and audio muting switch function as attenuators. The 32-step attenuator type volume control can be used in conjunction with the audio muting switch (capable of 20 dB attenuation) for fine adjustments even at low volume levels.

FM multipath switch lets antenna adjustments be performed aurally for minimizing multipath interference.

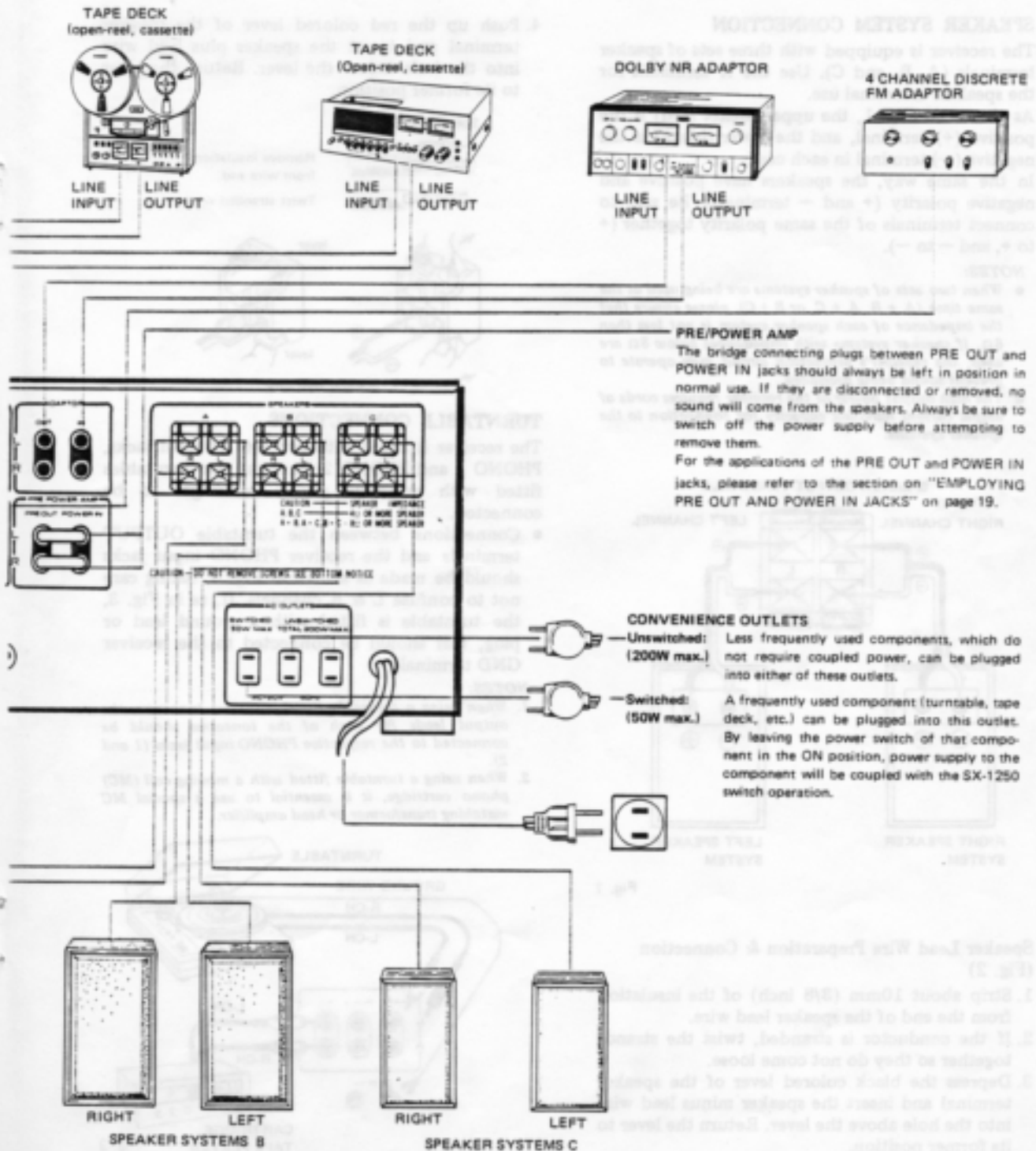
Impressive and Masterful Styling

Operational ease and an impression of built-in quality are evidenced by the front panel design which includes a long 250 mm dial scale. Large size heatsinks at the rear of both side panels attest to the stability of this high power amplifier.

CONNECTION DIAGRAM



CONNECTIONS



CONNECTIONS

SPEAKER SYSTEM CONNECTION

The receiver is equipped with three sets of speaker terminals (A, B, and C). Use the A terminals for the speakers in normal use.

As shown in Fig. 1, the upper socket (red) is the positive (+) terminal, and the lower (black) is the negative (-) terminal in each case.

In the same way, the speakers have positive and negative polarity (+ and - terminals). Be sure to connect terminals of the same polarity together (+ to +, and - to -).

NOTES:

- When two sets of speaker systems are being used at the same time (A + B, A + C, or B + C), please ensure that the impedance of each speaker system is not less than 8Ω. If speaker systems with impedances below 8Ω are used, the receiver's protection circuit may operate to prevent sound being produced.
- The high output power of the receiver requires cords of ample current handling capacity for connection to the speaker systems.

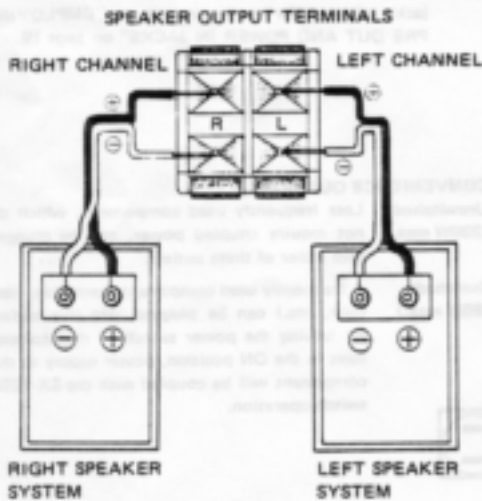


Fig. 1

Speaker Lead Wire Preparation & Connection (Fig. 2)

1. Strip about 10mm (3/8 inch) of the insulation from the end of the speaker lead wire.
2. If the conductor is stranded, twist the strands together so they do not come loose.
3. Depress the black colored lever of the speaker terminal and insert the speaker minus lead wire into the hole above the lever. Return the lever to its former position.

4. Push up the red colored lever of the speaker terminal and insert the speaker plus lead wire into the hole below the lever. Return the lever to its former position.

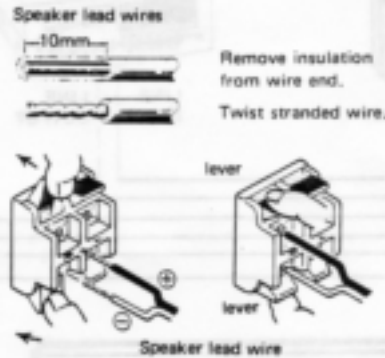


Fig. 2

TURNTABLE CONNECTIONS

The receiver is fitted with two sets of input jacks, PHONO 1 and PHONO 2, enabling two turntables fitted with magnetic phono cartridges to be connected.

- Connections between the turntable OUTPUT terminals and the receiver PHONO input jacks should be made as shown in Fig. 3, taking care not to confuse L & R channels. If, as in Fig. 3, the turntable is fitted with a ground lead or plug, this should be connected to the receiver GND terminal.

NOTES:

1. When using a turntable fitted with two tonearms, the output leads for each of the tonearms should be connected to the respective PHONO input jacks (1 and 2).
2. When using a turntable fitted with a moving coil (MC) phono cartridge, it is essential to use a special MC matching transformer or head amplifier.

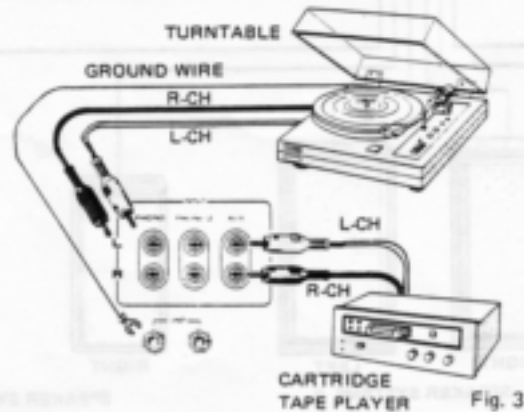


Fig. 3

USE OF THE AUX INPUT JACKS

These are a set of spare input jacks, which can be connected to a cartridge tape player, television sound tuner, or other signal source. The upper of the two jacks is the L (left) channel, and the lower is the R (right) channel (Fig. 3).

TAPE DECK CONNECTIONS

Two sets of recording output jacks (TAPE 1, 2 REC) and two sets of playback input jacks (TAPE 1, 2 PLAY) are provided, plus a DIN-type recording/playback jack (TAPE 2 REC/PLAY).

This means that in addition to normal recording and playback, two decks can be used to record at the same time, or to "dub" or duplicate recordings from one tape deck to the other.

Use the connecting cord(s) provided with the tape deck(s) to make the connections (see Fig. 4).

A tape deck can also be connected to the ADAPTOR jacks.

Connections for Recording

- The receiver output TAPE 1 REC jacks are connected to the recording input jacks (LINE INPUT) of the tape deck as shown in Fig. 4. The upper jack of each pair is the L (left) channel and the lower is the R (right) channel. When the tape deck is provided with a DIN-type jack for recording and playback, use an optional recording/playback cord to make the connection to the TAPE 2 REC/PLAY DIN jack.

NOTE:

As the recording/playback cord connects both recording and playback functions at the same time, there is no need to make separate connections to either TAPE 2 REC output jacks or TAPE 2 PLAY input jacks. If the ADAPTOR OUT jacks are to be used, connect them to the tape deck input (LINE INPUT) jacks.

- When using two tape decks, the second tape deck should be connected to the receiver TAPE 2 REC output jacks. If, however, the first deck has been connected to the DIN-type recording/playback jack, the second deck should be connected to the TAPE 1 REC output jacks.

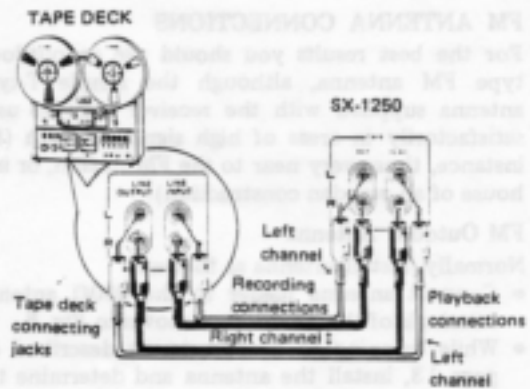


Fig. 4

Connections for Playback

- Connect the receiver TAPE 1 PLAY input jacks to the playback output jacks (LINE OUTPUT or TAPE MONITOR) on the tape deck. The upper jack of each pair is the L (left) channel, and the lower is the R (right) channel.

NOTE:

If the ADAPTOR IN jacks are to be used, connect them to the tape deck output (LINE OUTPUT) jacks.

- When using two tape decks, the second tape deck should be connected to the receiver TAPE 2 PLAY input jacks. If, however, the first deck has been connected to the DIN-type recording/playback jack (TAPE 2 REC/PLAY), the second deck should be connected to the TAPE 1 PLAY input jacks.

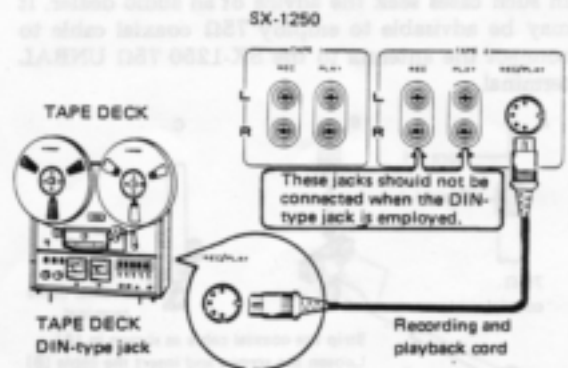


Fig. 5

ANTENNA AND GROUND CONNECTIONS

FM ANTENNA CONNECTIONS

For the best results you should use an outdoor-type FM antenna, although the simple T-type antenna supplied with the receiver may be used satisfactorily in areas of high signal strength (for instance, those very near to the FM station, or in a house of all-wooden construction).

FM Outdoor Antenna

Normally, install antenna as follows:

- Connect antenna feeder to the 300Ω antenna terminals of the SX-1250 as shown in Fig. 6.
- While listening to broadcasts, as described on page 13, install the antenna and determine the best location for optimum reception. Secure antenna firmly.

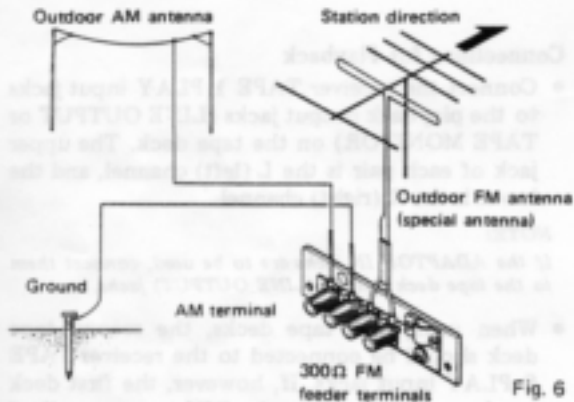


Fig. 6

Connection with Coaxial Cable

Urban areas with heavy traffic, industrial zones, or locations near high voltage power lines may experience interference even with a special FM antenna. In such cases seek the advice of an audio dealer. It may be advisable to employ 75Ω coaxial cable to connect the antenna to the SX-1250 75Ω UNBAL terminal.

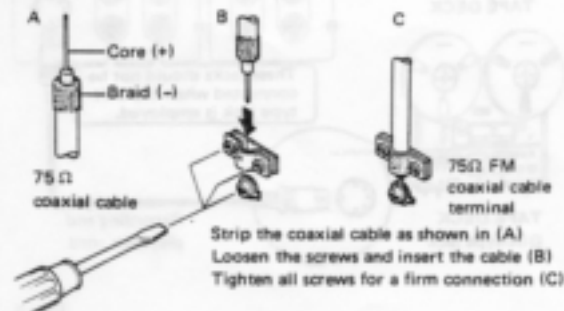


Fig. 7

T-type Antenna

When stations are nearby, and in wooden frame buildings, etc. where FM signals are strong, the accessory T-type antenna can be employed.

- As shown in Fig. 8, connect the T-type antenna to the 300Ω antenna terminals. Spread the 2 arms of the antenna horizontally and while listening to an FM station, position them for best reception. The antenna can then be taped to a wall or ceiling.

NOTE:

Consult audio dealer for detailed information on FM antennas and coaxial cable installations.

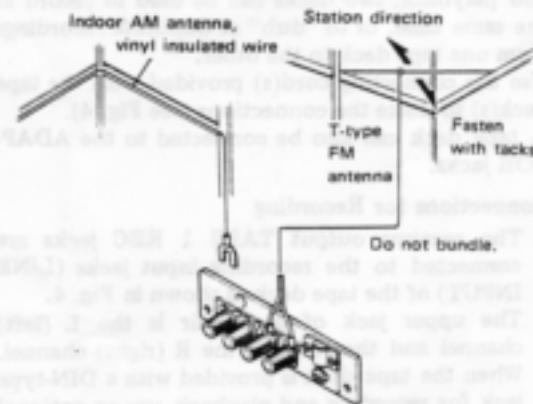


Fig. 8

FM Antenna Location

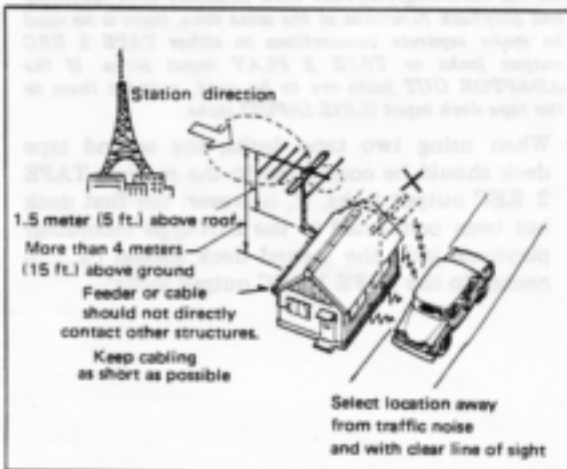


Fig. 9

AM ANTENNA CONNECTIONS

Normally, position the ferrite bar antenna (Fig. 10) for best reception while listening to an AM station as described on page 13.

AM Indoor Antenna

If reception is difficult with the bar antenna, an indoor AM antenna can be erected with vinyl insulated wire (5m to 10m) as shown in Fig. 8.

AM Outdoor Antenna

For optimum AM reception, an outdoor AM antenna using vinyl insulated wire can be erected as shown in Fig. 6.

GROUNDING

For maximum safety and noise reduction, connect the GND terminal to an earth ground (Fig. 6).

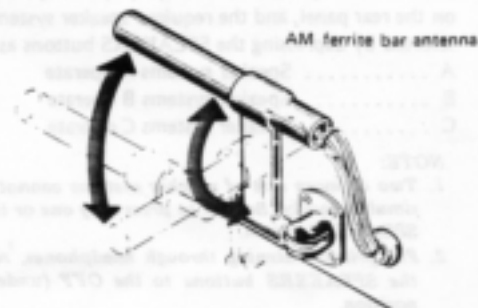


Fig. 10

FM MULTIPATH REFLECTION

This phenomenon is mainly caused as shown in Fig. 11, when the direct signals from an FM station are reflected by objects such as mountains and buildings. Both direct and reflected signals then enter the receiving antenna from different directions, and the slight timing difference due to the different paths results in mutual interference between the signals. Phase distortion, and deteriorated Signal-to-Noise ratio and channel separation affect the received sound.

Minimizing these effects calls for a sharply directional antenna, plus careful selection of the installation site and orientation.

Orientation

To minimize multipath reflections, adjust the antenna as follows:

1. Tune in the FM broadcast according to FM RECEPTION on page 13.
2. Depressing the FM MULTIPATH button will produce multipath sound through the speaker systems or headphones.
3. Turn the antenna, and find the direction which gives no sound or least sound, and tune for maximum deflection of the SIGNAL meter needle to the right.
4. Secure the antenna in this position for optimum reception of the FM broadcast.
5. Release the FM MULTIPATH button.

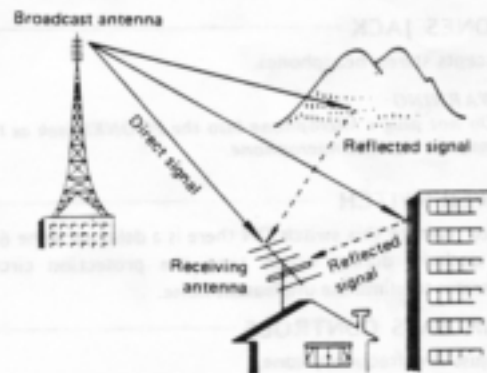


Fig. 11

FRONT PANEL FACILITIES

SPEAKER BUTTONS

Three sets of speaker terminals, A, B, and C, are provided on the rear panel, and the required speaker systems can be selected by depressing the **SPEAKERS** buttons as follows:

- A Speaker systems A operate
- B Speaker systems B operate
- C Speaker systems C operate

NOTE:

1. Two or more sets of speaker systems cannot be used simultaneously. Be sure to press only one or the other **SPEAKERS** switch.
2. For private listening through headphones, return all the **SPEAKERS** buttons to the **OFF** (undepressed) position.

FM TUNING METER

With the **SIGNAL** meter needle deflected to the right, make fine adjustment by centering the **FM TUNING** meter needle (indicating optimum reception).

SIGNAL METER

For AM and FM station tuning.

AM tuning: Tune for maximum deflection of the **SIGNAL** meter needle to the right.

FM tuning: Both the **SIGNAL** and **FM TUNING** meters work together. The optimum point of the **SIGNAL** meter needle is the same as in AM tuning. Then use the **FM TUNING** meter.

SPEAKER SYSTEM INDICATOR

FM STEREO INDICATOR

PHONES JACK

Accepts stereo headphones.

WARNING:

Do not plug a microphone into the **PHONES** jack as this may damage the microphone.

POWER SWITCH

After turning this switch **ON** there is a delay of some 6 to 8 seconds, during which time the protection circuit operates to eliminate unpleasant noise.

TWIN BASS CONTROLS

Adjust low frequency tone.

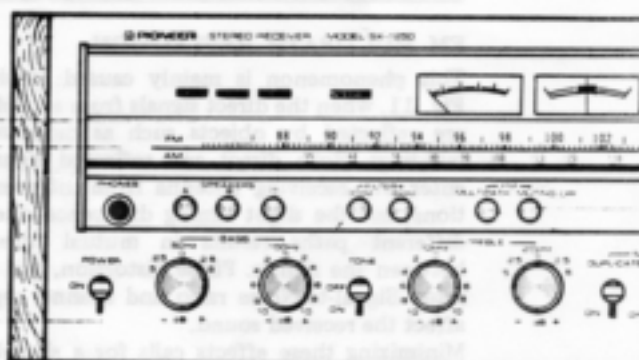
100Hz: Adjusts frequency band below 400Hz. Control effectiveness at 100Hz is ± 10 dB.

50Hz: Provides additional control for the frequency band below 200Hz. Control effectiveness at 50Hz is ± 5 dB.

See additional description on page 15.

STONE SWITCH

In the **OFF** (up) position, this switch causes the amplifier section to operate with a flat frequency response regardless of the tone control setting.



LOW CUT (30Hz) FILTER BUTTON

When low-pitched rumble (from turntable motor or other source) is obtrusive depress this button to provide 12dB/octave attenuation at frequencies below 30Hz. If no interference is experienced, release this button.

HIGH CUT (8kHz) FILTER BUTTON

When high frequency scratch noise (from worn records or other source) is unpleasant, depress this button to provide 12dB/octave attenuation at frequencies above 8kHz. If there is no interference, release this button.

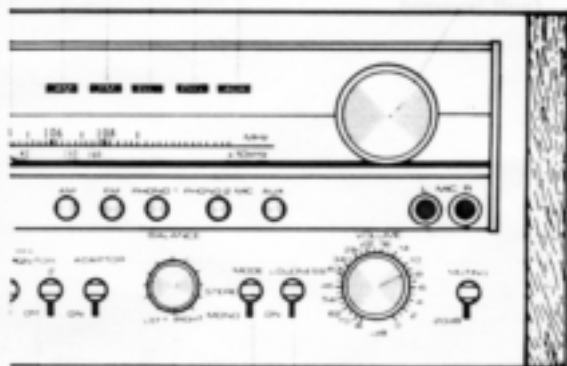
TUNING KNOB

Select the station and tune for optimum reception by observing the SIGNAL meter for AM stations, and both SIGNAL and TUNING meters for FM stations.

FM MUTING BUTTON

Leave this button undepressed (in the ON position) to suppress unpleasant interstation noise while tuning between FM stations. Low-strength signals may also be suppressed by this function, so to pick up a weak station depress this button to the OFF position.

PROGRAM SOURCE INDICATOR



FM MULTIPATH BUTTON

When selecting the best position for the FM antenna, depress this button so that multipath sound is heard from the speaker systems. For details see page 9 "Orientation". To listen to FM broadcasts, release this button.

TWIN TREBLE CONTROLS

Adjusts high frequency tone.

10kHz: Adjusts frequency band above 2.5kHz. Control effectiveness at 10kHz is ± 10 dB.

20kHz: Provides additional control for the frequency band above 5kHz. Control effectiveness at 20kHz is ± 5 dB.

See additional description on page 15.

MIC JACKS (L and R)

For connecting the left and right channel microphones.

NOTE:

Use high impedance (above 20k Ω) microphones with 6mm diam. phone plugs.

VOLUME CONTROL

Adjusts output level to speakers and headphones.

Scale is graduated in dB, and when used in conjunction with the MUTING switch, finer and wider range attenuation can be performed. See additional description on page 12.

AUDIO MUTING SWITCH - 20dB

Set to -20dB to attenuate the audio output by 20dB. This convenient feature saves having to disturb the VOLUME control, for example when answering the telephone.

LOUDNESS SWITCH

Set to ON when listening at low volume. The frequency response of the human ear varies according to the listening volume, and the ON position compensates for hearing response by emphasizing the bass and treble.

MODE SWITCH

Set to STEREO for normal stereo operation. When set to MONO left and right channel signals will be mixed and reproduced monophonically from both speaker systems.

BALANCE CONTROL

Adjusts the balance between the sound volume from the left and right speaker systems or headphones.

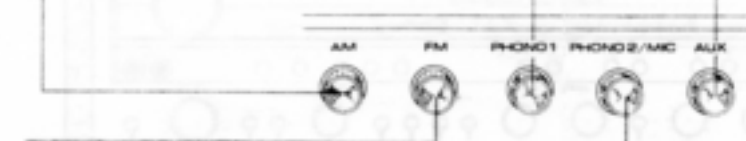
FUNCTION SELECTOR BUTTONS

To select the program source, push each button as follows:

NOTE:

Only one **FUNCTION** button should be depressed at a time.

AM For AM broadcast reception.



FM For FM stereo reception. Automatically receives monophonically during FM monophonic broadcasts. The **STEREO** indicator lights up when the broadcast is in stereo.

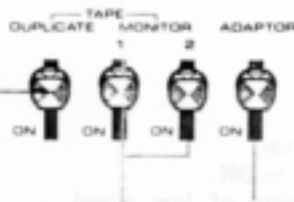
PHONO 1 To operate a turntable connected to the PHONO 1 input jacks.

AUX For listening to audio component (cartridge tape player, TV sound tuner, etc.) connected to the AUX input jacks.

PHONO 2/MIC. As above for PHONO 2 jacks, or for reproduction through microphones connected to the MIC jack on the front panel. Note: when a microphone is connected the turntable connected to the PHONO 2 jacks cannot be used.

TAPE DUPLICATE SWITCH

Set this switch in the **ON** (down) position to duplicate or edit a recorded tape using two tape decks.



TAPE MONITOR (1, 2) SWITCHES

Set these switches to the **ON** (down) position as follows:

- 1 With a tape deck connected to the **TAPE 1** jacks (**REC** and **PLAY**), either playback or monitoring of a recording in progress are possible.
- 2 Same as in 1 above, with a tape deck connected to the **TAPE 2** jacks (**REC** and **PLAY**).

For normal use, leave in the **OFF** (up) positions.

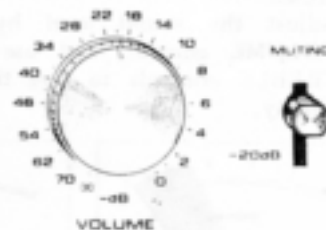
ADAPTOR SWITCH

When employing adaptor components, such as a graphic equalizer adaptor, RG processor, or Dolby NR adaptor, depress this **ADAPTOR** switch to **ON**. See additional description on p.17.

VOLUME CONTROL AND AUDIO MUTING SWITCH

The extremely high power output of the SX-1250 can be finely controlled by combining the calibrated **VOLUME** control and the **AUDIO MUTING** switch.

The **AUDIO MUTING** switch can also be used to briefly lower the volume when changing records or tapes.



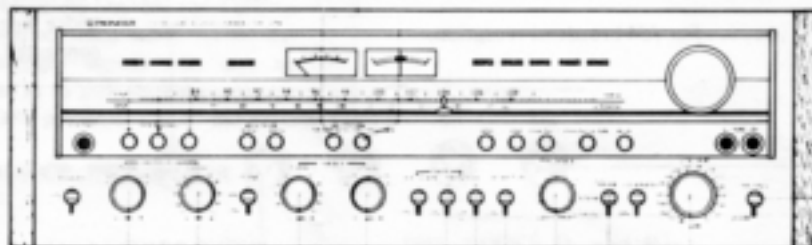
PRIOR TO SWITCHING POWER ON

Before switching on the power, set the various controls as follows:

Depress the SPEAKERS (A, B, C) button according to the employed terminals

Release the FM MULTIPATH
and FM MUTING buttons

Turn the AUDIO MUTING switch off (up)



Set the TREBLE and BASS controls to the midway
positions (the "0" positions)

Set the VOLUME control to ∞
(fully counter clockwise)

Turn the TAPE MONITOR and ADAPTOR
switches to OFF (up)

Turn the MODE switch to
STEREO (up)

Set the BALANCE control to the midway position

FM RECEPTION

1. Depress the FM selector button.
2. Set the FM MUTING button to ON.
Note, however, that in areas of low signal strength the signal may be suppressed. In this case only, the FM MUTING button should be depressed to the OFF position.
3. Select the station by means of the TUNING knob.
Best reception is obtained when the SIGNAL meter needle deflects to the extreme right, and the TUNING meter needle is exactly in the center, as shown in Fig. 12. If the broadcast is stereophonic, the STEREO indicator lamp will come on; it will not illuminate for monophonic broadcasts.
4. Adjust the sound level by means of the VOLUME control, and use the BASS and TREBLE controls to give the required tone quality.



FM Reception

Fig. 12

AM RECEPTION

1. Depress the AM selector button.
2. Turn the TUNING knob to select your station.
Best reception is obtained when the SIGNAL meter needle deflects to the extreme right (Fig. 13).
3. Adjust the VOLUME, BASS and TREBLE controls for the listening level and tone quality of your preference.

NOTE:

If, when listening to either FM or AM broadcasts, listening pleasure is seriously affected by poor sensitivity or strong interference, refer to the section "ANTENNA AND GROUND CONNECTIONS," on page 8 and make any necessary changes.



AM Reception

Fig. 13

PLAYING RECORDS

1. Set the **FUNCTION** selector to either **PHONO 1** or **PHONO 2/MIC**, depending upon which input jacks the turntable is connected to.
2. Operate the turntable to play the record.
3. Adjust the **VOLUME**, **BASS**, and **TREBLE** controls for the listening level and tone quality of your preference.

NOTE:

*In order to eliminate the unpleasant noise which can mark the start of a record, set the **AUDIO MUTING** switch to -20dB, releasing it after the stylus has completed the run-in, and then adjust the **VOLUME** to give the sound level of your choice.*

USING THE AUX JACKS

To play equipment connected to the **AUX** jacks, proceed as follows:

1. Set the **FUNCTION** selector by depressing the **AUX** button.
2. Operate the attached component.
3. Adjust the **VOLUME**, **BASS**, and **TREBLE** controls for the listening level and tone quality of your preference.

MICROPHONES

1. Connect the microphones to the **MIC** jacks.
2. Set the **FUNCTION** selector by depressing the **PHONO 2/MIC** button.
3. Adjust the sound level by turning the **VOLUME** control gradually to the right. The midway setting of the **BASS** and **TREBLE** controls will usually give best results.

NOTES:

1. Under certain conditions microphones are liable to give rise to "howling" or feedback noise. Be careful not to raise the volume too high when the microphone is close to the speaker systems or in a room with a great deal of resonance. This tendency can be reduced by setting the **TREBLE** and **BASS** controls to their "0" positions, or by switching the **TONE** switch **OFF** (up).
2. When a microphone has only been connected to one of the microphone jacks (either **L** or **R**), sound will only be heard from the corresponding left-hand or right-hand speaker systems as long as the **MODE** switch is set at **STEREO**. For the sound to be heard from both speaker systems, the **MONO** mode should be selected.
3. Regardless of the **MODE** switch setting, only one tape track can be recorded if only one microphone is connected. Therefore only one **LEVEL** meter will register during recording, and sound will only be heard from one speaker system if played back in the **STEREO** mode.

PROTECTION CIRCUIT

For some 6 to 8 seconds after the receiver is switched **ON**, no sound will be heard. This is due to the operation of protection circuits which are designed to safeguard transistors and speakers from possible damage, due chiefly to switching transients, etc. Should the receiver remain silent for considerably longer than this, switch off and check the speaker system connections. Should the receiver suddenly go silent while you are listening to it, and a continuous series of "clicks" can be heard due to relay contacts opening and closing within the receiver, this can be an indication of a short circuit in the speaker system connections. Switch off, and re-check the speaker system impedances, etc.

The protection circuit re-sets itself automatically, so that normal operation is resumed as soon as the fault is cured.

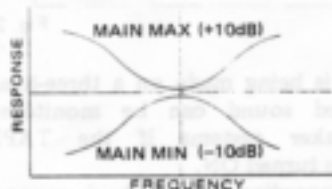
EFFECTIVE OPERATION

BASS AND TREBLE TWIN CONTROLS

A twin tone control system is provided which incorporates main and sub controls, as illustrated in Fig. 14. Tone adjustments can be performed in the same manner as with conventional tone controls by using only the main controls. The sub-controls provide the same function as changing the turnover (or roll over) frequency. Approximately 3,000 tone combinations can be obtained by using both controls.

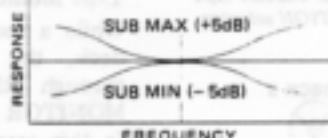


Fig. 14



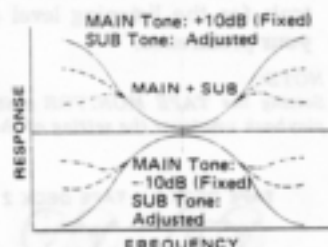
MAIN Tone control characteristic.

Fig. 15



SUB Tone control characteristic.

Fig. 16

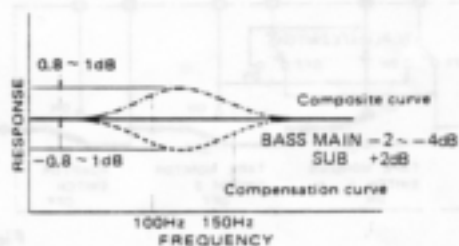


Both Tone control characteristic.

Fig. 17

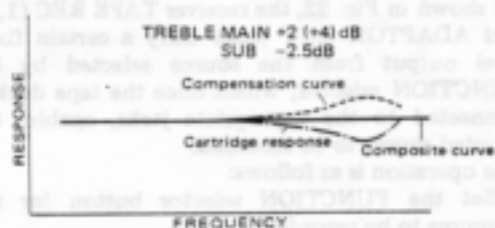
Typical Applications

- Low frequencies in the 100Hz-150Hz region, which delicately influence bass impression, can be enhanced by a 0.8dB-1.0dB margin. While retaining an overall flat impression, slightly more weight can be obtained in the low frequency band. Since the opposite adjustment can also be performed, such effects as standing waves and extended reverberations, which can occur in steel framework buildings and lend an unnatural influence, are often improved. See Fig. 18.
- High frequencies can be adjusted by the twin TREBLE controls to compensate for quavering which often occurs with moving magnet (MM) type phono cartridges. To cite another example, when conventional tone controls are used to enhance high frequencies from records, ultra high frequency peaking can occur from the phono cartridge. This drawback is eliminated by the twin control system, which can enhance 8kHz-10kHz frequencies while maintaining an overall flat response. See Fig. 19.
- Careful adjustment of the twin BASS and TREBLE controls can provide an effect equivalent to enhancing the midrange. This is a useful technique for obtaining a close up of a singer's voice or similar applications. See Fig. 20. Regardless of the twin controls settings, a completely flat response can be obtained at any time by setting the TONE switch to OFF. The delicate effects of the tone controls can thus be confirmed when adjusting them according to the program source.



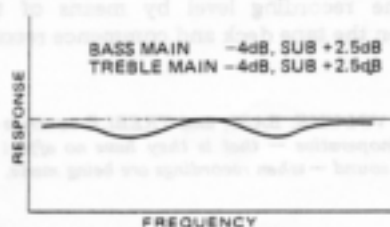
To improve unnatural low frequencies.

Fig. 18



Compensation for high frequency slacking of cartridge.

Fig. 19



Relatively enhancing the midrange.

Fig. 20

TAPE DECK OPERATIONS

PLAYBACK

1. According to the TAPE PLAY (1, 2) or ADAPTOR IN jacks to which the tape deck is connected, either the TAPE MONITOR 1 or 2 switches or the ADAPTOR switch should be set to ON (see Fig. 21).
2. Operate the tape deck controls for playback.
3. Adjust the VOLUME, BASS, and TREBLE controls for the listening level and tone quality of your preference.

NOTE:

Setting the TAPE MONITOR switch to ON enables tape playback whatever the setting of the FUNCTION selector.

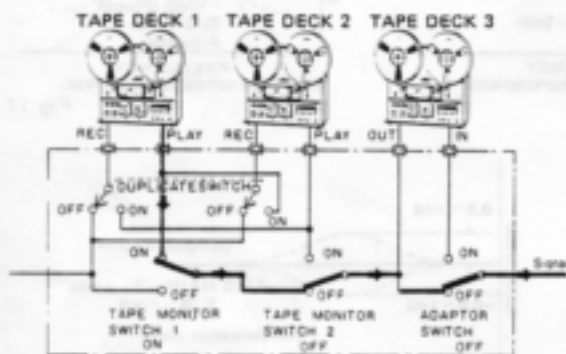


Fig. 21

RECORDING

As shown in Fig. 22, the receiver TAPE REC (1, 2) and ADAPTOR OUT jacks carry a certain fixed level output from the source selected by the FUNCTION selector, which once the tape deck is connected to the appropriate jacks, enables the selected source to be recorded.

The operation is as follows:

1. Set the FUNCTION selector button for the source to be recorded.
2. Play the selected program source.
3. Adjust the recording level by means of the controls on the tape deck and commence recording.

NOTE:

The receiver VOLUME, BASS, and TREBLE controls are completely inoperative — that is they have no effect on the recorded sound — when recordings are being made.

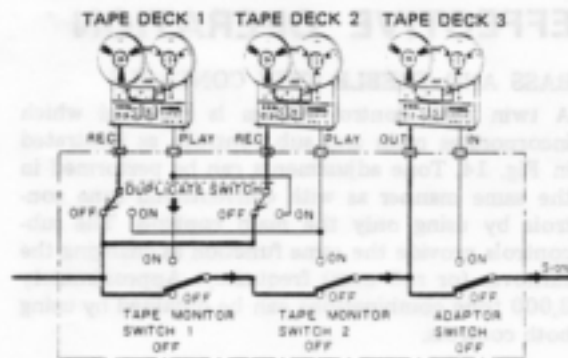


Fig. 22

Tape Monitoring

While a recording is being made on a three-head deck, the recorded sound can be monitored through the speaker systems if the TAPE MONITOR switch is turned ON.

In this case both recording and playback connections must be made.

DUPLICATING OR EDITING RECORDED TAPES

By using two tape decks, a recording of, say, a complete FM broadcast can be made, and then those items which you want for your permanent "tape library" can be selected and re-recorded onto another tape.

1. Connect the two tape decks as shown in Fig. 23.
2. Set the TAPE DUPLICATE switch to the ON position.
3. Select one of the tape decks (1 or 2) to playback the pre-recorded tape, and use the other tape deck to make the copy recording.
4. When recording with tape deck 1, TAPE MONITOR switch 1 should be switched ON to monitor the sound being recorded, and when recording with deck 2, TAPE MONITOR switch 2 should be switched ON for monitoring (refer again to Fig. 23).

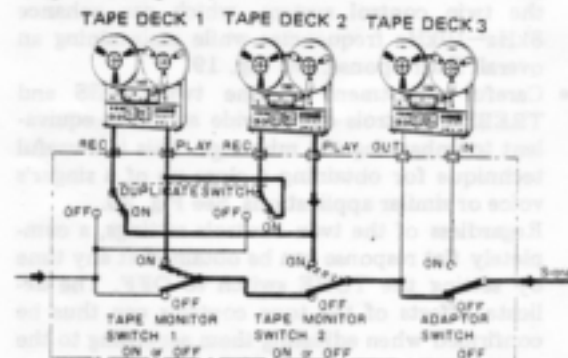


Fig. 23

ADAPTOR JACKS FOR INCREASED VERSATILITY

USE OF THE ADAPTOR JACKS

If a Dolby adaptor is connected to the receiver ADAPTOR jacks, not only can FM Dolby broadcasts be played back, but if a tape deck is connected to the adaptor itself, Dolby system recording and playback are available.

RECEPTION OF FM DOLBY BROADCASTS

Dolby system FM broadcasts can be received by making the following connections:

1. Set the DE-EMPHASIS switch on the receiver rear panel to "25 μ sec." position.
2. Connect the Dolby adaptor as shown in Fig. 24 to the ADAPTOR IN and OUT jacks.
3. Set the FUNCTION selector to FM by depressing the FM button, and tune in to an FM Dolby system broadcast.
4. Turn the ADAPTOR switch ON.

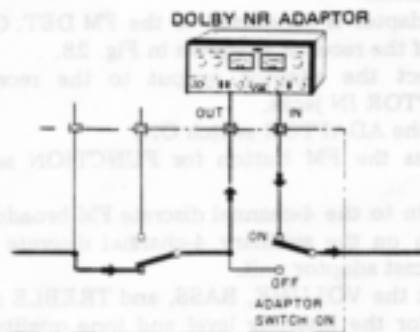


Fig. 24

Dolby Recording

1. As shown in Fig. 25, connect the Dolby adaptor output jacks to the tape deck recording input jacks (LINE INPUT).
2. Select the program source of your choice with the FUNCTION selector.

NOTE:

If you wish to monitor the sound being recorded with the Dolby adaptor, turn the ADAPTOR switch ON.

Dolby Playback

1. Connect the tape deck playback output jacks (LINE OUTPUT) to the input jacks of the Dolby adaptor.
2. Turn the ADAPTOR switch ON, and playback your Dolby system recordings.

NOTE:

For detailed instructions on connections, etc., please see the instruction manual provided with your Dolby adaptor.

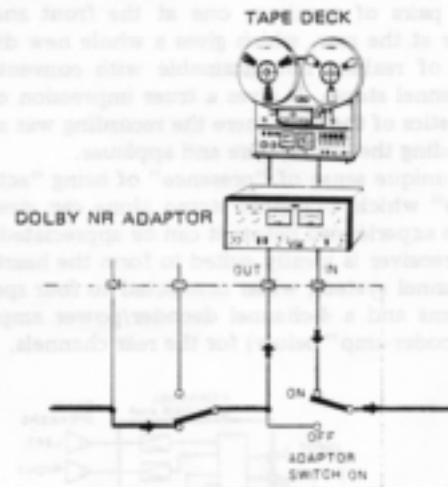


Fig. 25

OTHER ADAPTORS CURRENTLY AVAILABLE

The provision of these convenient adaptor jacks in addition to the normal tape REC/PLAY jacks, enables other sophisticated adaptor units (e.g. a graphic equalizer, RG dynamic processor, etc.) to be connected without forfeiting the full tape monitoring and duplicating facility. When using an adaptor, the program source can be taken from the function selector or the tape deck output terminals. Fig. 26 illustrates an RG dynamic processor connected to the ADAPTOR terminals.

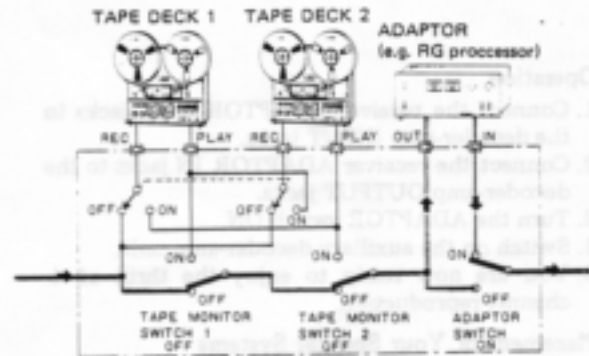


Fig. 26

SETTING UP A 4-CHANNEL SYSTEM

As shown in Fig. 27, a 4-channel system consists of two pairs of speakers, one at the front and the other at the rear, which gives a whole new dimension of realism not attainable with conventional 2-channel stereo. It gives a truer impression of the acoustics of the hall where the recording was made, including the atmosphere and applause.

The unique sense of "presence" of being "actually there" which 4-channel stereo alone can give, has to be experienced before it can be appreciated, and this receiver is ideally suited to form the heart of a 4-channel system, when connected to four speaker systems and a 4-channel decoder/power amplifier ("decoder-amp" below) for the rear channels.

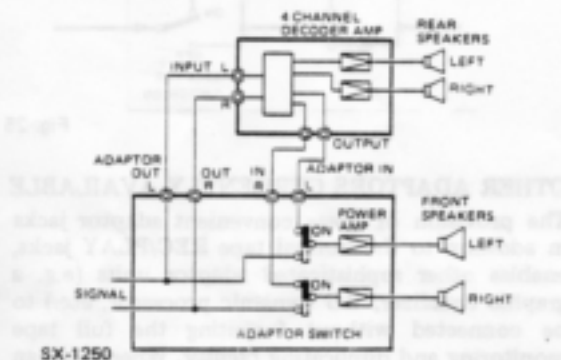


Fig. 27

Operation

1. Connect the receiver ADAPTOR OUT jacks to the decoder-amp INPUT jacks.
2. Connect the receiver ADAPTOR IN jacks to the decoder-amp OUTPUT jacks.
3. Turn the ADAPTOR switch ON.
4. Switch on the auxiliary decoder-amp unit.
5. You are now ready to enjoy the thrill of 4-channel reproduction.

Placement of Your Speaker Systems

As shown in Fig. 29, two pairs of speaker systems are located at the front left and right, and the rear left and right (four in all). Connect the speakers located in FRONT to the receiver, and the REAR speakers to the power amplifier for the rear channels.

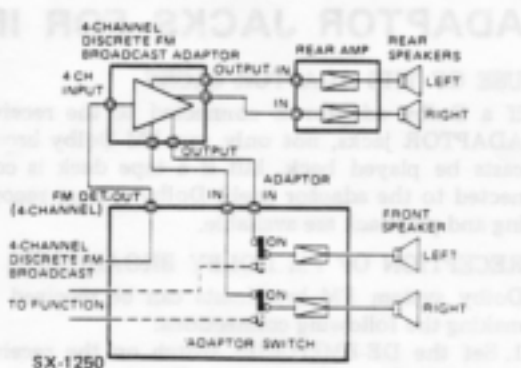


Fig. 28

Receiving 4 Channel FM Broadcasts

If 4-channel multiplex discrete FM broadcasts are available, the addition of a 4-channel discrete FM broadcast adaptor ("adaptor" below) will enable full 4-channel reproduction of the broadcasts from your receiver.

1. The adaptor is connected to the FM DET. OUT jack of the receiver as shown in Fig. 28.
2. Connect the adaptor output to the receiver ADAPTOR IN jacks.
3. Turn the ADAPTOR switch ON.
4. Depress the FM button for FUNCTION selection.
5. Tune in to the 4-channel discrete FM broadcast.
6. Switch on the auxiliary 4-channel discrete FM broadcast adaptor unit.
7. Adjust the VOLUME, BASS, and TREBLE controls for the listening level and tone quality of your preference.

NOTE:

For detailed instructions on connections, etc., see the instruction manual supplied with the adaptor.

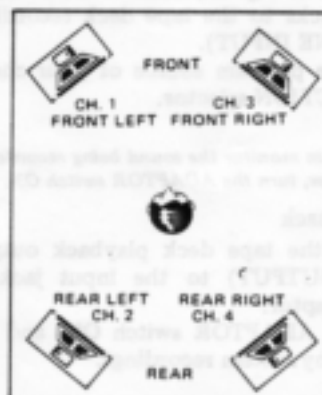


Fig. 29

EMPLOYING PRE OUT AND POWER IN JACKS

INDEPENDENT PREAMPLIFIER FUNCTION

The preamplifier section of the SX-1250 can be used independently to drive an external power amplifier. This allows comparison listening between the built-in SX-1250 power amplifier and a homebuilt or other separate power amplifier (Fig. 30).

INDEPENDENT POWER AMPLIFIER FUNCTION

An external preamplifier can also be connected to the SX-1250 power amplifier section to compose a stereo system.

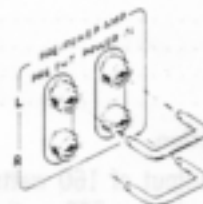


Fig. 30

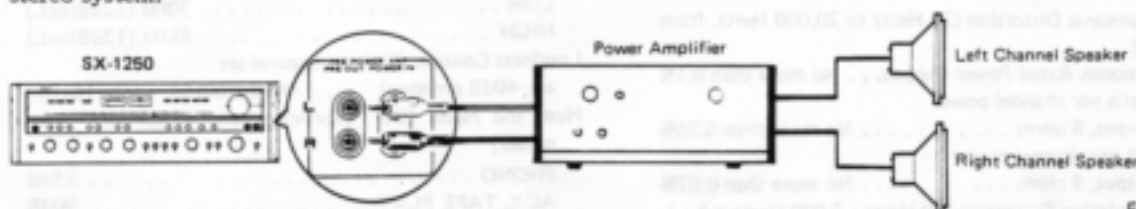


Fig. 31

CONNECTIONS FOR SETTING UP A MULTI-AMPLIFIER SYSTEM

By purchasing an electronic crossover network and one or two additional power amplifiers, a two- or three-way multi-amplifier system can be constructed. This splits up the audible frequency range into different frequency bands, to operate amplifiers and speakers ideally suited to each band. The results are reduced intermodulation distortion and improved damping and crossover characteristics. Use of the multi-amplifier system is as follows:

1. Remove both of the plugs bridging the PRE OUT and POWER IN jacks (Fig. 30).
2. Connect the PRE OUT jacks to the input jacks of the crossover network.
3. Connect the POWER IN jacks to the LOW range

output jacks of the crossover network.

4. Connect the HIGH range output jacks of the crossover network to the input jacks of a separate power amplifier for the high frequency range.
5. Connect the speakers for the lower frequencies to the receiver, and those for the higher frequencies to the separate amplifier.

The levels of the different frequency ranges are adjustable by the crossover network. For detailed instructions on the use of the crossover network, please refer to the instruction manual provided with it.

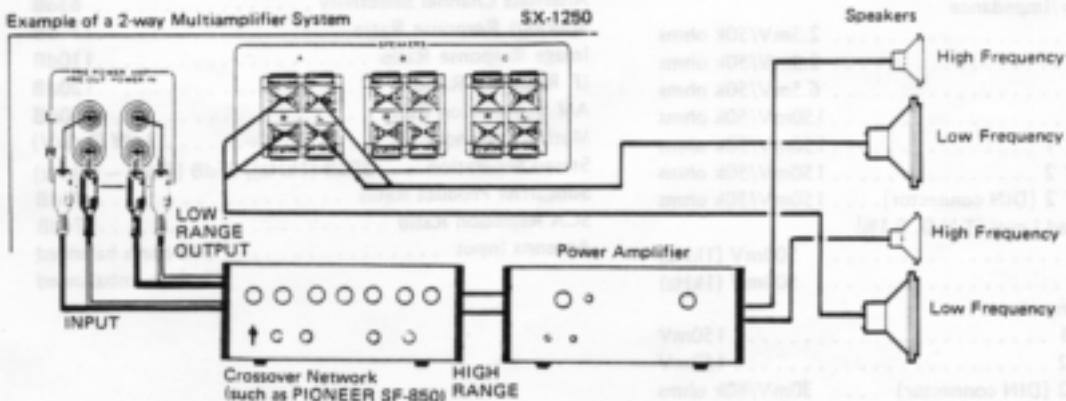


Fig. 32

SPECIFICATIONS

Semiconductors

FETs	5
ICs	6
Transistors	82
Diodes	60

Power Amplifier Section

Continuous power output of 160 watts*per channel min. RMS, at 8 ohms or 200 watts*per channel at 4 ohms from 20 Hertz to 20,000 Hertz with no more than 0.1% total harmonic distortion.

Total Harmonic Distortion (20 Hertz to 20,000 Hertz, from AUX)

Continuous Rated Power Output... No more than 0.1% 80 watts per channel power

output, 8 ohms

1 watt per channel power

output, 8 ohms

Intermodulation Distortion (50 Hertz : 7,000 Hertz = 4 : 1, from AUX)

Continuous Rated Power Output... No more than 0.1% 80 watts per channel power

output, 8 ohms

1 watt per channel power

output, 8 ohms

Frequency Response

Input Sensitivity/Impedance

POWER AMP IN

Output

Speaker

Headphone

Damping Factor

(20Hz to 20,000Hz, 8 ohms)

Hum and Noise (IHF, short-circuited, A Network) ..

Preamplifier Section

Input Sensitivity/Impedance

PHONO 1

PHONO 2

MIC

AUX

TAPE PLAY 1

TAPE PLAY 2

TAPE PLAY 2 (DIN connector)

PHONO Overload Level (T.H.D. 0.1%)

PHONO 1

PHONO 2

Output Level/Impedance

TAPE REC 1

TAPE REC 2

TAPE REC 2 (DIN connector)

PRE OUT

Total Harmonic Distortion

(20Hz to 20,000Hz, 1V output) ..

Frequency Response

PHONO (RIAA equalization) ..

AUX, TAPE PLAY

Tone Control

BASS

MAIN \pm 10dB (100Hz)

SUB \pm 5dB (-50Hz)

TREBLE

MAIN \pm 10dB (10kHz)

SUB \pm 5dB (20kHz)

Filter

LOW

HIGH

Loudness Contour (Volume control set

at -40dB position)

Hum and Noise (IHF, short-circuited, A Network, rated

power)

PHONO

AUX, TAPE PLAY

Muting

FM Section

Usable Sensitivity

MONO ... 8.7dBf (1.5 μ V)

STEREO ... 14.5dBf (2.9 μ V)

50dB Quieting Sensitivity ..

MONO ... 11.5dBf (2.1 μ V)

STEREO ... 36.0dBf (35 μ V)

Signal-to-Noise Ratio at 65dBf ..

MONO

STEREO

Distortion at 65dBf 100Hz

MONO

STEREO

1kHz

MONO

STEREO

6kHz

MONO

STEREO

Frequency Response

Capture Ratio

Alternate Channel Selectivity

Spurious Response Ratio

Image Response Ratio

IF Response Ratio

AM Suppression Ratio

Muting Threshold

Stereo Separation ..

Subcarrier Product Ratio

SCA Rejection Ratio

Antenna Input

300 ohms balanced

75 ohms unbalanced

AM Section

Sensitivity (IHF, Ferrite antenna)	300 μ V/m
(IHF, Ext. antenna)	15 μ V
Selectivity	40dB
Signal-to-Noise Ratio	55dB
Image Response Ratio	65dB
IF Response Ratio	85dB
Antenna	Built-in Ferrite Loopstick Antenna

Miscellaneous

Power Requirements	120V 60Hz
Power Consumption	650W (UL, CSA) 1200W (max.)
Dimensions	556(W) x 186.5(H) x 464.5(D) mm 21-7/8(W) x 7-3/8(H) x 18-1/4(D) in
Weight Without Package	29.2kg (64 lb 4 oz)
With Package	33.2kg (73 lb 1 oz)

Furnished Parts

FM T-type Antenna	1
Operating Instructions	1
Hex. Wrench	1

* Measured pursuant to Federal Trade Commission's Trade Regulation rule on Power Output Claims for Amplifiers.

NOTE:

Specifications and the design subject to possible modification without notice due to improvements.

HEX WRENCH

The accessory hex. wrench is provided for removing the VOLUME and TUNING knobs, or for tightening its setscrew in the event it becomes loose.

If required, loosen the setscrew by inserting the wrench into the hole on the side of the knob and turning the wrench counterclockwise. Be particularly careful not to scratch the front panel when employing the wrench.



CONDITIONS FREQUENTLY MISTAKEN FOR MALFUNCTION

If your stereo appears to malfunction, first check such things as the controls (power switch, function selector, tape monitor, etc.) and connecting cords (components connected correctly).

Noise: There are a variety of noises relating to the operation of a hi-fi unit. These are generally divided into two types; (1) the unit is faulty (a transistor or part has deteriorated) and (2) an external source is adding to the unit.

When a hi-fi unit produces an unpleasant noise, it is

often assumed that the unit is faulty, but statistical records indicate that the majority of noises produced in hi-fi acoustic units result from external sources of noise: Due to the inherent high sensitivity and the high fidelity in reproduction, the unit amplifies and reproduces extraneous noises, however small, into definite output noise. If your receiver produces a noise, check according to the following table and trace out the source of noise for the appropriate corrective action.

	SYMPTOM	SUSPECTED SOURCE OF NOISE	DIAGNOSIS AND REMEDY
WHEN LISTENING TO BROADCASTS	Continuous or intermittent buzzing noise.	<ul style="list-style-type: none"> Static (lightning) Fluorescent lamp, motor, or thermostat may be in use in house or in the vicinity of the house. 	In many cases, it is very difficult to remove the source of noise. In order to make the radio input larger than the noise level, set up a good outdoor antenna and make a complete grounding.
	When a station is tuned in, hum is mixed in the program.	<ul style="list-style-type: none"> Poor fluorescent lamp, motor, or electric heater may be in use in house or near the house. 	Reversing the line plug may occasionally alleviate this noise problem. Usually it is very difficult to eliminate the noise.
	Hissing sound noise in AM (medium wave) reception.	<ul style="list-style-type: none"> The frequency of an adjacent station is interfering with that of the station being tuned in (10kHz beat interference). TV set is on in the same house with the receiver. 	Impossible to remove such interference. If the cause of such noise is the TV set, increase the distance between the TV set and receiver.
	Static noise (in particular, when automobiles run close to the house).	<ul style="list-style-type: none"> White noise generated from automobile engines. High frequency sewing machine or welding machine being used near your house. 	In an area surrounded by hills or high buildings, the FM input signals are very weak. Thus the noise limiter in the circuit loses its function. Set up an FM outdoor antenna having many director elements.
	Reception of FM stereo program contains more noise than FM mono program.	<ul style="list-style-type: none"> Note that the service area covered by an FM stereo broadcast is about 50% of that of a regular mono broadcast. 	Increasing the FM input signal may alleviate this problem. Use an exclusive FM outdoor antenna instead of the indoor T-type antenna.
WHEN PLAYING RECORDS	Hum or buzz. When switched to radio reception, the noise disappears.	<ul style="list-style-type: none"> Poor connection of shielded wire. (a) Jack connection is loose. (b) Line cord of fluorescent lamp passes near the shielded wire. (c) Poor grounding. (d) Ham transmitting station or TV transmitting station is near your house. (e) 	Correct the conditions stated in (a), (b), (c) or (d). In case of (e), report it to an official authority.
	Output tone quality is poor and mixed with noise. Treble is not clear.	<ul style="list-style-type: none"> Stylus is worn. (a) Record is worn. (b) Dust adhering to stylus. (c) Stylus is improperly mounted. (d) Stylus pressure is not correct. (e) The TREBLE level is too high. 	Check (a) through (e) and correct the condition. Lower the TREBLE level.
	In playing a record, increasing the volume causes howling.	<ul style="list-style-type: none"> Distance between the turntable and the speakers is too short. The turntable or speakers supports are unstable. 	Increase the distance or rearrange the installation of the unit and speakers. (Installing the turntable on a firm, solid stand may alleviate this problem.) Do not enhance the BASS sound level excessively.
WHEN USING MICROPHONE	Howling occurs	<ul style="list-style-type: none"> Feed back between microphone and speakers. 	<ul style="list-style-type: none"> Keep microphone away from speakers Do not set the VOLUME control too high. Set BASS and TREBLE controls to center positions.

PIONEER ELECTRONIC CORPORATION

4-1, Meguro 1-Chome, Meguro-ku, Tokyo 153, Japan

U.S. PIONEER ELECTRONICS CORPORATION

75 Oxford Drive, Moonachie, New Jersey 07074, U.S.A.

PIONEER ELECTRONIC (EUROPE) N.V.

Luthagen-Heaven 9, 2030 Antwerp, Belgium

PIONEER ELECTRONICS AUSTRALIA PTY. LTD.

178-184 Boundary Road, Brieside, Victoria 3185, Australia

Printed in Japan

<ARB-164-A>