

STEREO TURNTABLE

# PL-120

OPERATING INSTRUCTIONS

KUT  
KLT  
KCT



WARNING: TO PREVENT FIRE OR SHOCK HAZARD,  
DO NOT EXPOSE THIS APPLIANCE TO RAIN OR  
MOISTURE.

 PIONEER

---

Welcome to the happy family of Pioneer hi-fi enthusiasts. You have made a wise choice in selecting the Pioneer Stereo Turntable, model PL-12D, because this precision component, when combined with other high-quality stereo equipment, will play your records with accuracy and bring out the

hidden beauty in your record collection. Model PL-12D is supplied without a phono cartridge — please use any good stereo cartridge that complies with international standards (Installation of a phono cartridge is explained on page 5).

## FEATURES

### PRECISION-ENGINEERED BELT DRIVE SYSTEM

The motor drives the turntable platter not via a system of trouble-prone idlers but via the tried-and-true Pioneer belt transmission, shutting out motor vibrations and rumble while improving the overall signal-to-noise ratio. The belt, made of durable polyurethane, resists temperature changes as well as age remarkably well.

### SYNCHRONOUS MOTOR FOR ACCURATE, CONSISTENT SPEED

The 4-pole synchronous motor features highly accurate and stable speed and revolves with practically no vibrations. Stability is further improved by the fine machining of the aluminium alloy platter.

### ANTI-SKATING DEVICE ENSURES PERFECT TRACKING

To keep the stylus tracking perfect along the center of the record groove. (in other words, to compensate for the inward thrust of the tonearm), a specially developed spring-activated anti-skating device is provided. Its effect is to guarantee fine channel separation when playing stereo records.

### S-SHAPED TONEARM WITH LATERAL BALANCE WEIGHT

The light-weight and light-tracking tonearm is shaped for almost perfect geometry and minimum tracking error. What's more, it is equipped with an adjustable lateral balance weight so that vertical stylus movements will not lead to lateral unbalances.

### CONVENIENT OPERATION AND ADJUSTMENTS

The tonearm is raised and lowered by an oil-damped lifter which is controlled via the three-position function lever. For easy adjustment of the exact overhang for practically any phono cartridge, a retractable overhang gauge is built in. The head shell conforms to international standard specifications and can be detached from the tonearm, which greatly facilitates cartridge mounting and stylus replacement.

### CONSERVATIVE, FUNCTIONAL STYLING

With its dark brown walnut-finished base and balanced black-silver colors, this turntable looks like the precision instrument that it is.

Before using this turntable, you should lubricate the oil holes while reading "LUBRICATION." Because this unit may fall short of oil during the shipments.

## INSTALLATION

Install your Model PL-12D with the following points in mind.

- The place must be well-ventilated and free from humidity and dust.
- The unit should not be exposed to direct sunlight.
- The unit should not be placed near a heat source.
- Choosing the location for a turntable is especially important.

First, it should be protected from vibration or shock. If placed on the floor, the turntable will receive vibration from footsteps, for example. A position on a bookshelf is therefore recommended. Additional protection from vibration may be had by placing absorbent padding such as rubber sponge underneath the unit. The turntable should not touch the amplifier or receiver. Usually, two or three inches of separation is sufficient.

## TYPICAL STEREO SETUP

The drawings show a typical installation, and the relationship of turntable, stereo amplifier or receiver and speaker systems (Figs. 1 and 2).

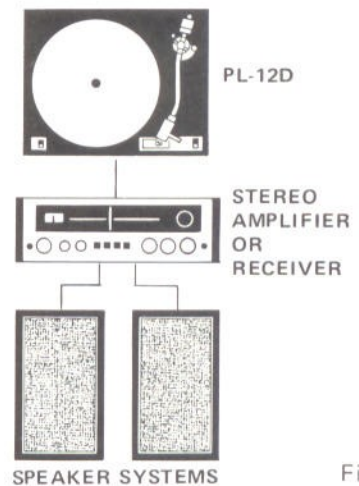

Fig. 1

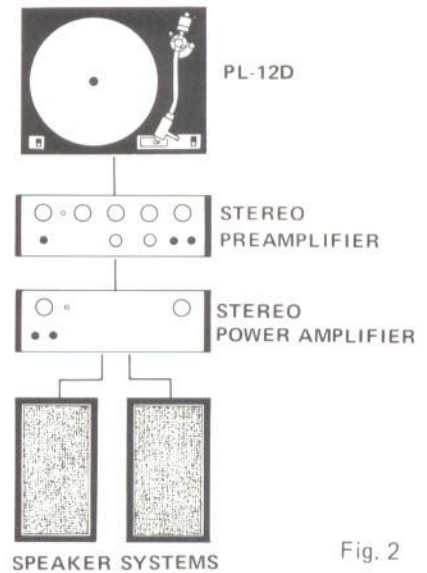

Fig. 2



## ASSEMBLY

The turntable platter and precision parts are packed separately from the wooden base in the same packing case.

When you unpack the packing case, take them out with care so as not to scratch or break them, and assemble them as follows:

### REMOVING THE TONEARM PACKING

Check and remove the accessories stored in the white polystyrol packing on the tonearm. Then remove the packing. Accessories stored there: (Fig. 3).

1. EP record adaptor
2. Small screwdriver
3. Lubricator
4. Weight plate, etc.

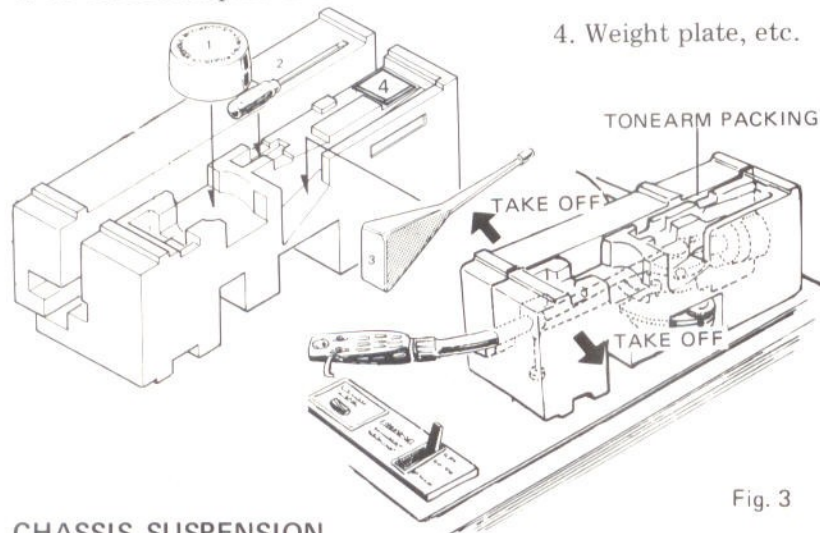

Fig. 3

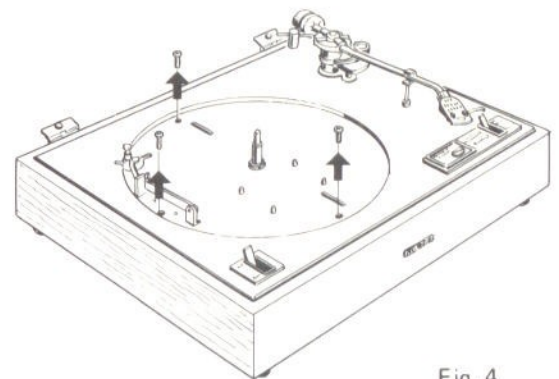

Fig. 4

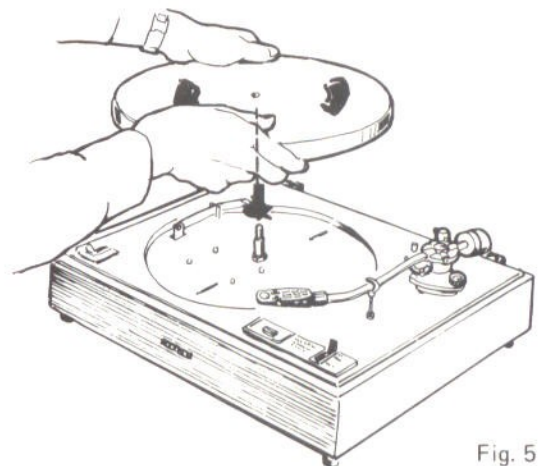

Fig. 5

### CHASSIS SUSPENSION

For protection during shipment, the chassis is secured to the base with the three red screws. These must be removed before assembling the turntable. The chassis will then float on its vibration-absorbing spring suspension (Fig. 4).

### MOUNTING OF TURNTABLE PLATTER

The turntable platter and rubber mat are packed separately. Take them out. First put the turntable on the center shaft. After the drive belt has been set on the motor pulley, place the rubber mat on the platter (Fig. 5).

### SETTING THE BELT ON THE MOTOR PULLEY

Set the speed selector lever to the 33 rpm position. Pulling the ribbon attached to the drive belt, lead the belt through the belt guide and set it on the smaller diameter portion (the upper portion) of the motor pulley. After the belt has been properly set on the motor pulley, remove the ribbon (Fig. 6).

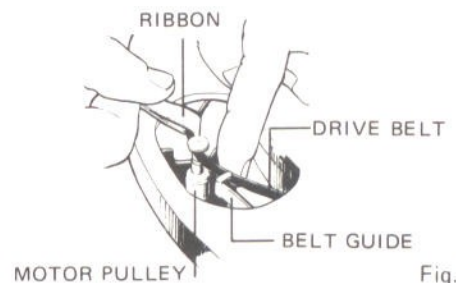

Fig. 6

### ATTACHING THE DUST COVER

1. Hold dust cover vertically (Fig. 7 A).
2. From behind, slip cut-outs in cover hinges over pegs on base hinges.
3. Push dust cover about 1/3 in. to the right (as seen from the back) to secure hinges (Fig. 7 B).

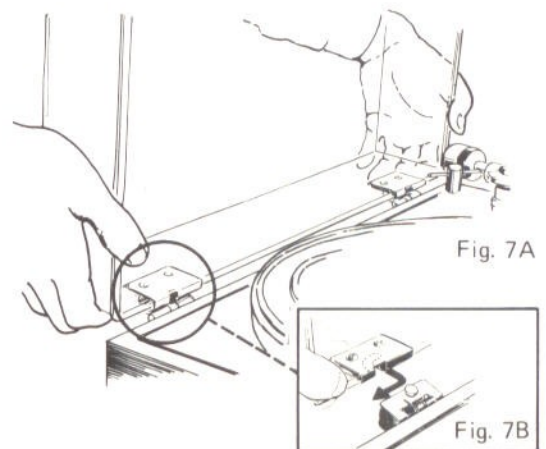
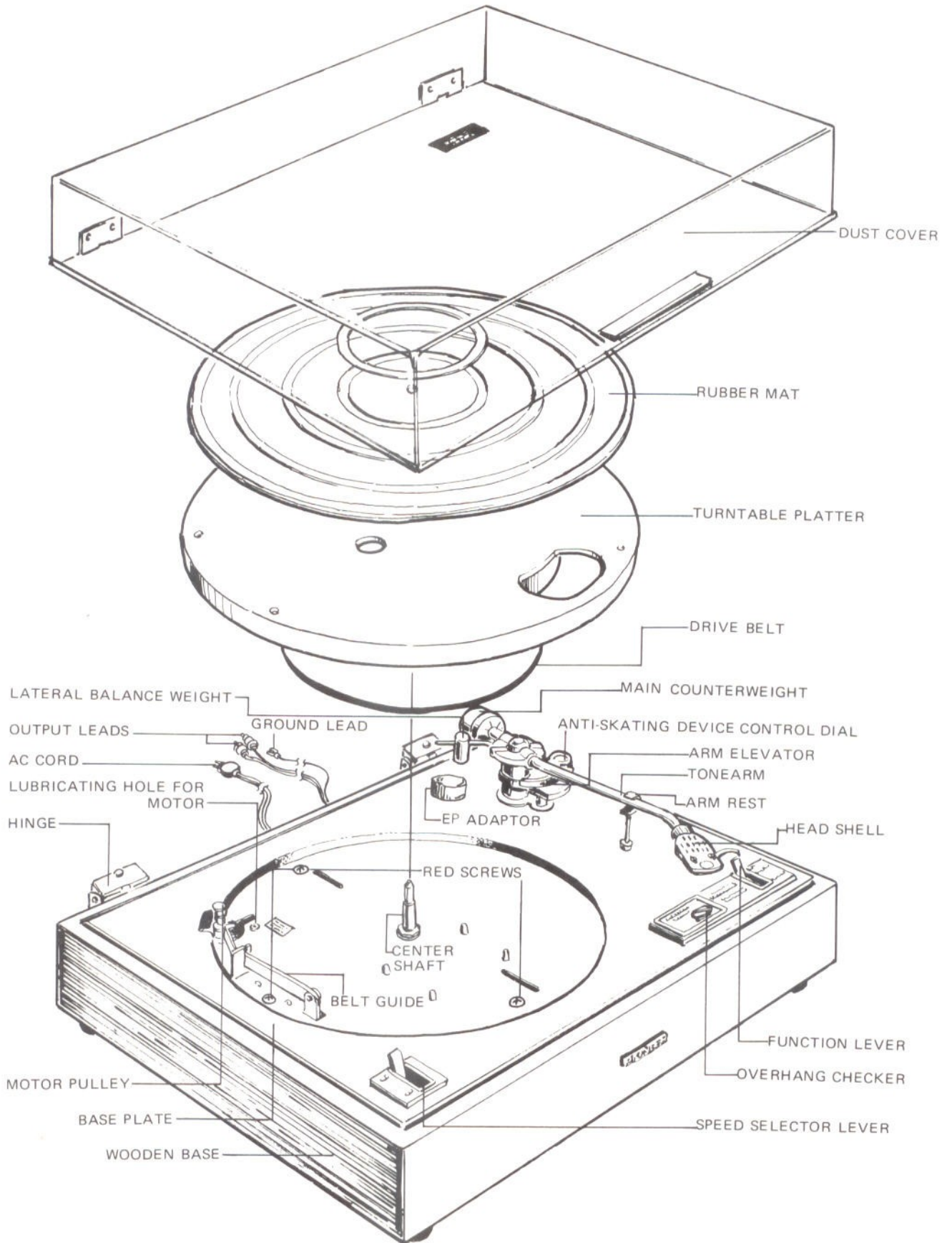

Fig. 7A

Fig. 7B





## ATTACHING A PHONO CARTRIDGE

The color-coded pin connectors in the head shell conform to the international EIA standard. Attach the cartridge according to the drawing (Fig. 8).

Then plug the head shell into the front end of the tonearm and tighten it by giving the tonearm sleeve approximately one turn.

### NOTE:

When attaching the cartridge to the head shell, we recommend the Pioneer's head shells PP-304 or PP-305 to be used.

### OVERHANG ADJUSTMENT

For optimum performance, the cartridge should be adjusted to obtain proper stylus overhang.

Loosen the two cartridge holding screws a little, and move the cartridge back and forth in the head shell so that the stylus tip comes exactly over the white line in the "OVERHANG CHECKER." For easier checking, this "OVERHANG CHECKER" can be pulled up (Fig. 9).

If the cartridge weight lighter than 8.5 grams, remove the sub-weight from the end of the tonearm (Fig. 10).

## TRACKING FORCE ADJUSTMENT

### HORIZONTAL BALANCING

Remove the stylus guard from the cartridge. Free the tonearm from its rest, but be sure to hold it carefully and not to drop it during the following adjustments.

Move the main counterweight slowly back and forth (by turning it) until the tonearm floats in horizontal position. Keeping the weight in this position, turn only the tracking force dial ring so that the zero aligns with the back index line on the tonearm (Fig. 11).

### APPLYING THE TRACKING FORCE

With the tonearm in floating condition, turn the counterweight and align the desired number (0 to 3.5 grams) with the index line. For the correct tracking force, please refer to the instructions supplied with the phono cartridge.

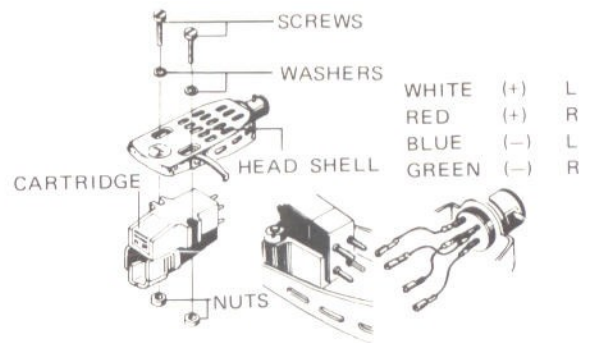

Fig. 8

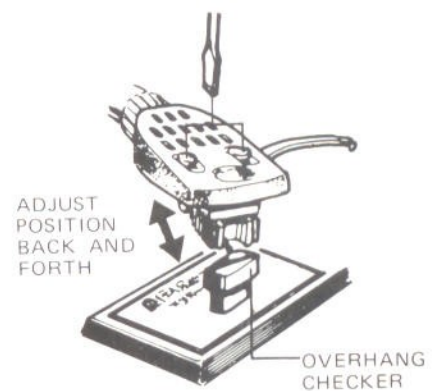

Fig. 9

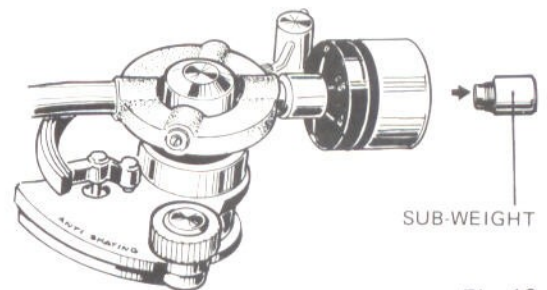

Fig. 10

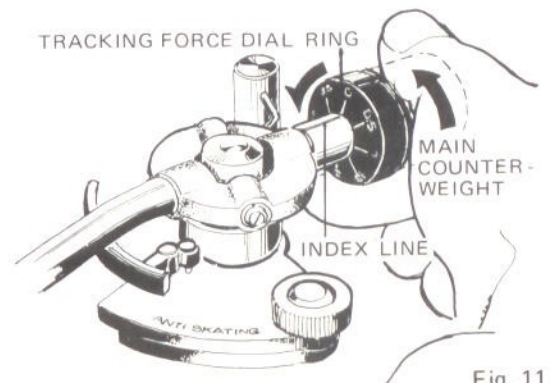

Fig. 11

## LATERAL BALANCE

First loosen the lateral balance weight-secured screw with a screwdriver, as shown in Fig. 12. Then give the weight a 10 ~ 15mm slide outward. After this adjustment once made, no adjustment is required any more even if you replace the cartridge with a new one.

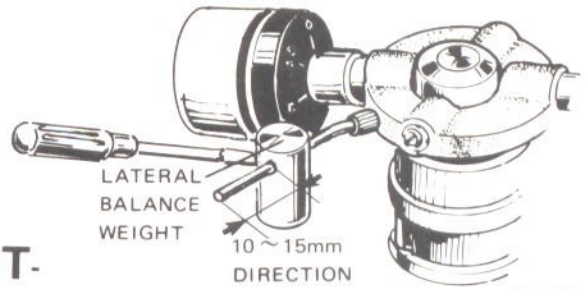

Fig. 12

## ANTI-SKATING DEVICE ADJUSTMENT

Finally, apply the proper amount of anti-skating device, in accordance with the selected tracking force. Simply turn the anti-skating device dial to the number that corresponds to the tracking force in grams (Fig. 13).

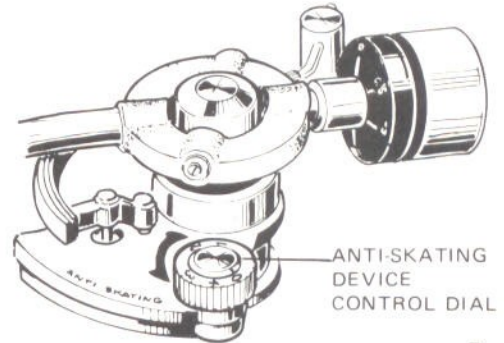

Fig. 13

## CONNECTION TO THE STEREO AMPLIFIER

The phono inputs on the amplifier to which the turntable should be connected must be chosen in accordance with the type of phono cartridge to be used.

- With moving magnet or induced magnet type cartridge: Connect to PHONO MAG inputs on amplifier.
- With low-output moving coil type cartridges: Connect to PHONO MC inputs. If these are not provided on your amplifier, a step-up transformer will be required. Consult with your Pioneer dealer.
- With crystal or ceramic cartridge: Connect to PHONO CRYSTAL or AUX inputs.

In either case, connect the red output plug from the turntable to the amplifier's right channel input, the white plug to the left channel input.

The third wire (black) with the split lug on its end is the ground wire. Connect this to the GROUND or GND terminal of your amplifier. Do not forget to make this connection, because it is vital for avoiding hum and noise.

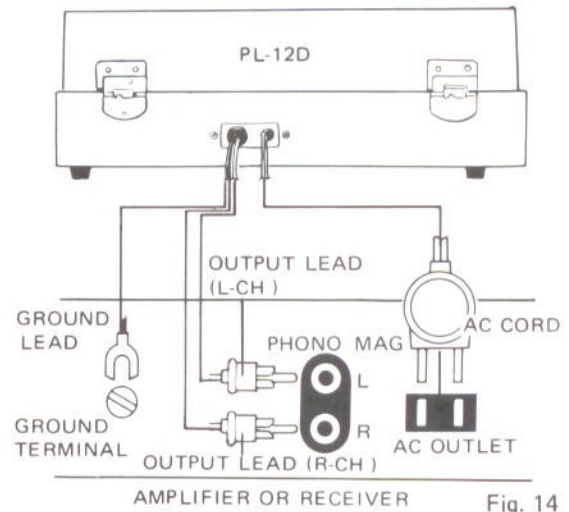

Fig. 14



# OPERATION

## SPEED SELECTOR LEVER

The PL-12D is a two-speed type; 33-1/3 rpm and 45 rpm. Setting the lever to either speed position will automatically set the turntable for operation at that speed.

Fig. 15 illustrates the setting of the speed selector lever.

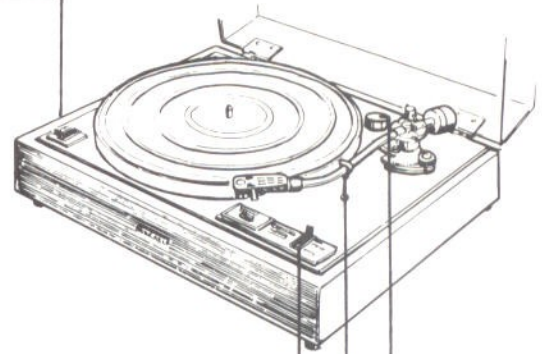
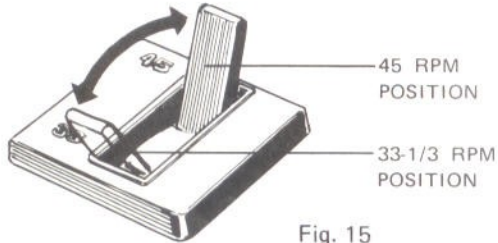

Fig. 15

## FUNCTION LEVER

- OFF: Tonearm is lifted off the record. Motor is turned off.
- ON-UP: Tonearm is lifted off the record. Motor is operating.
- DOWN: Tonearm floats down gently upon the record. Motor is operating (Fig. 16).

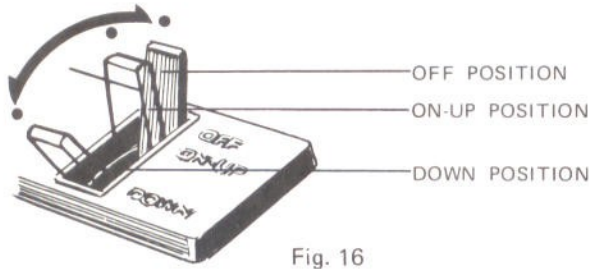

Fig. 16

## ARM REST

The arm rest supports the tonearm when it is not in use.

## EP RECORD ADAPTOR

An EP record adaptor is supplied in the accessory group, which permits 45 rpm records with large center holes to be played. When the adaptor is not in use, keep it on the pin located in the upper right of the base plate.



Fig. 17



## HOW TO OPERATE THE TURNTABLE

1. Put the record to be played on the turntable.
2. Remove the stylus cover.
3. Set the function lever to position ON/UP. The turntable begins to rotate.
4. Set the speed selector lever at the correct position : 33 or 45rpm.
5. Take the tonearm off its rest and move it over the initial record grooves, or the section from which you want to play the record.
6. Set the function lever to position DOWN. Playing begins.
7. At the end of the record, move the function lever to position OFF. The tonearm will lift from the record and can then be returned manually to its rest position.

## IMPORTANT! OBSERVE CAREFULLY

1. Never touch the speed selector lever unless the turntable is rotating. The speed can be changed only while the turntable is rotating.
2. Never obstruct the turntable by hand while it is rotating. This may cause damage.
3. Always keep the stylus clean. Remove dust with a soft brush.
4. Always keep your records scrupulously clean, too. Clean them with a commercially available record cleaner or cloth.
5. Never touch the stylus with your finger. Hands off.

## WHAT TO DO IN CASE OF TROUBLE

Wow (unstable sound)	Oil on the belt, motor pulley or inner turntable rim.	Wipe clean. Use a soft cloth with a little alcohol, but never benzine or the like.
Hum (low-pitched noise)	No ground connection.	Check connection of black ground wire to amplifier's GND terminal.
	Output cable too close to amplifier's transformer.	Change turntable position, move output cable away from amplifier.
Howling (loud roar)	Occurs only when volume is turned up. Caused by sound from loudspeakers hitting phono cartridge directly.	Turn down volume. Move turntable further away from loudspeakers.

## LUBRICATION

Before applying oil to the turntable, remove the turntable platter by using the following procedure:

1. Return the tonearm onto the arm rest, then support the tonearm with the arm clasper of the arm rest.
2. Remove the drive belt with fingers from the motor pulley.
3. Pull the turntable platter upward with two fingers inserted into the turntable platter's two openings. See Fig. 18.

If the turntable platter should not be removed easily, pull it up strongly, with care taken not to damage any part of the turntable.

### WHEN LUBRICATION IS REQUIRED . . .

Mechanical noises and wow and flutter usually result from the lack of lubricant in rotating parts. Lubricate the specified spots at least once every two months if your turntable is used for home entertainment, and two to three if used for professional purposes. Apply one or two drops to the base of the center shaft Fig. 19.

When lubricating, be careful not to let oil adhere such as the motor pulley, belt, or inner rim. If oil should adhere to these parts, wipe it off with a cloth moistened with pure alcohol.

### WHEN LUBRICATION IS OVER . . .

Replace the turntable platter on the center shaft, then re-set the drive belt around the motor pulley.

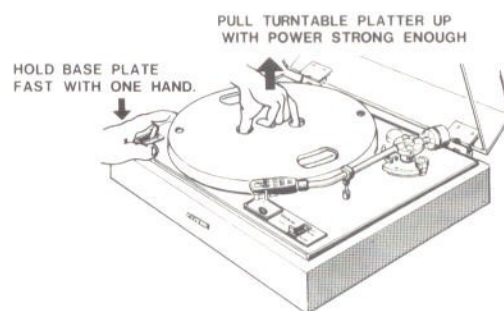

Fig. 18



Fig. 19



## SPECIFICATIONS

### MOTOR AND TURNTABLE

Motor:	4-pole synchronous motor
Turntable drive:	Belt-driven
Speed:	Two speeds, 33-1/3 and 45 rpm
Speed accuracy:	1.0% or less
Wow and flutter:	0.1% (WRMS) or less
S/N:	47dB or more
Turntable platter:	12" (30 cm) diameter aluminium alloy

### TO NEARM

Tonearm type:	Static balance type, pipe arm (S-shaped)
Effective arm length:	221mm
Usable cartridge weight:	4 ~ 10g

Available of any cartridge conforming to EIA standard.

### SUBFUNCTIONS

- Anti-skating device control
- Lateral balance control
- Light aluminum head shell plug-in type
- Hydraulic cueing device

### FURNISHED PARTS

Lubricator:	1	EP record adaptor:	1
Screwdriver:	1	Cartridge mounting screws:	10
Sub-weight:	1	Cartridge mounting nuts:	2
Weight plate:	1	Cartridge mounting washers:	2
Operating instructions:	one copy		

### MISCELLANEOUS

Power requirements:	AC 120V, 60Hz
Power consumption:	10W (Max.)
Dimensions:	16-15/16(W) x 6-5/16(H) x 13-3/4(D) in. 430(W) x 160.5(H) x 349(D) mm
Weight:	16 lb/7.5 kg

- NOTES:
- Above specifications refer to combination of turntable PL-12D with the Pioneer phono cartridge PC-30.
  - Specifications and the design subject to possible modification without notice due to improvements.

**PIONEER ELECTRONIC CORPORATION**

4-1, 1-Chome, Meguro, Meguro-ku, Tokyo 153, Japan

**U.S. PIONEER ELECTRONICS CORPORATION**

75 Oxford Drive, Moonachie, New Jersey 07074, U.S.A.

**PIONEER ELECTRONIC (EUROPE) N.V.**

Meir-Center Meir 21, 2000 Antwerp, Belgium

**PIONEER ELECTRONICS AUSTRALIA PTY. LTD.**

256-B City Road, South Melbourne, Victoria 3205, Australia

Printed in Japan  
<KRB-018-G>

