



**marantz®**

**Model 2230  
Stereophonic  
Receiver**

MARANTZ CO., INC. 20525 NORDHOFF STREET, CHATSWORTH, CALIFORNIA 91311  
A WHOLLY-OWNED SUBSIDIARY OF SUPERSCOPE INC., CHATSWORTH, CALIFORNIA 91311

# TABLE OF CONTENTS

Preparation for Use	
Rear Panel Connections	2
Phono	2
Tape In	2
Tape Out	2
Auxiliary	3
Quadradial	3
Main In and Pre Out	3
Loudspeaker Systems	3
FM Antenna	4
Antenna Attenuator	5
AM Antenna	5
Connection to AC Outlet	5
Convenience Outlet	5
Simplified Operating Procedure	5
Tuning Meters	6
Tuning	6
Mono Switch	6
Tape Monitor Switch	6
Loudness Switch	6
Low Filter Switch	6
Hi Filter Switch	6
Muting Switch and Level Control	6
Main Controls and Switches	7
Selector Switch	7
Balance Control	7
Volume Control	7
Bass Mid and Treble Controls	7
Main-Spkr-Remote Switch	7
Front Panel Jacks	7
Dubbing Out	7
Dubbing In	7
Stereophones	8
Some Suggestion on Using Tape Recorders with Your Model 2230	8
Recording and Playback	8
Recording	8
Playback	8
Making Two Recordings Simultaneously	8
Recording a Long-Duration Program	8
Copying and Editing	9
Converting Your Stereo System to 4- channel	9
Technical Description	11
General	11
Functional Description	11
Front End	11
IF Stages	12
Limiter	12
FM Stereo Demodulator	12

Muting Circuit	12
AM Tuner	12
Selector Switch	12
Tape Signals	13
Tape Monitor Switch	13
Phono Signals	13
Mono Functions	13
Control Circuits	13
Balance Control	13
Volume Control	13
Tone Amplifier	13
Hi-Low Filters	13
General	13
Service Note	14

## LIST OF ILLUSTRATIONS

1. Rear Panel Connection Facilities and Adjustments	2
2. Loudspeaker System Connections	3
3. FM/AM Antenna Connection	4
4. AM Ferrite-rod Antenna	5
5. Front Panel Controls and Jacks	7
6. Stereophone Plug	8
7. Arrangement of Two Tape Recorder	9
8. Connection Diagram	10
9. Functional Block Diagram	11
10. Packing Instructions	14

## FOREWORD

For optimum performance and enjoyment from your Model 2230 Stereo Receiver, please study these instructions carefully. Installation and operation are not complicated, but its flexibility and features deserve your becoming familiar with its controls and connections.

This manual is divided into two parts. The first covers installation and operation in simple, non-technical language. The second describes the 2230 in more detail with technical specifications, functional explanations, and special application discussions.

For quick identification of the controls and connections, references to them are printed in boldface type, exactly as they appear on the front and rear panels of your Receiver.

## GENERAL DESCRIPTION

Your Marantz Model 2230 all solid state receiver incorporates the advanced circuitry for which Marantz is famous in the audio component industry.

Unparalleled technology and innovation made possible this combination of three superb component sections on a single chassis: Tuner, Preamplifier, and Power Amplifier. Internal connections between these component sections ensure optimum performance from each section, and retain the full flexibility of separate components. The extraordinary flexibility of your Model 2230 permits the connection of: two stereo pairs of loudspeakers; headphones; a turntable or record changer; an additional tuner (such as SW or LW) and a TV sound source. Record, playback, and copying capabilities are included for a tape playback deck or two recorders.

## AFTER UNPACKING

It is advisable to save all original packing material to prevent damage should you wish to transport or ship the Receiver (refer to Figure 10 for packing instructions).

Please inspect your Model 2230 carefully for any signs of damage in transit. It has undergone stringent quality control inspection and tests prior to packing, and left the factory in perfect operating condition.

If the unit is damaged, notify the carrier without delay.

Only the consignee may institute a claim with the carrier for damage during shipment. However, the Marantz Company will cooperate fully in such an event.

Save the damaged carton as evidence for inspection by the carrier.

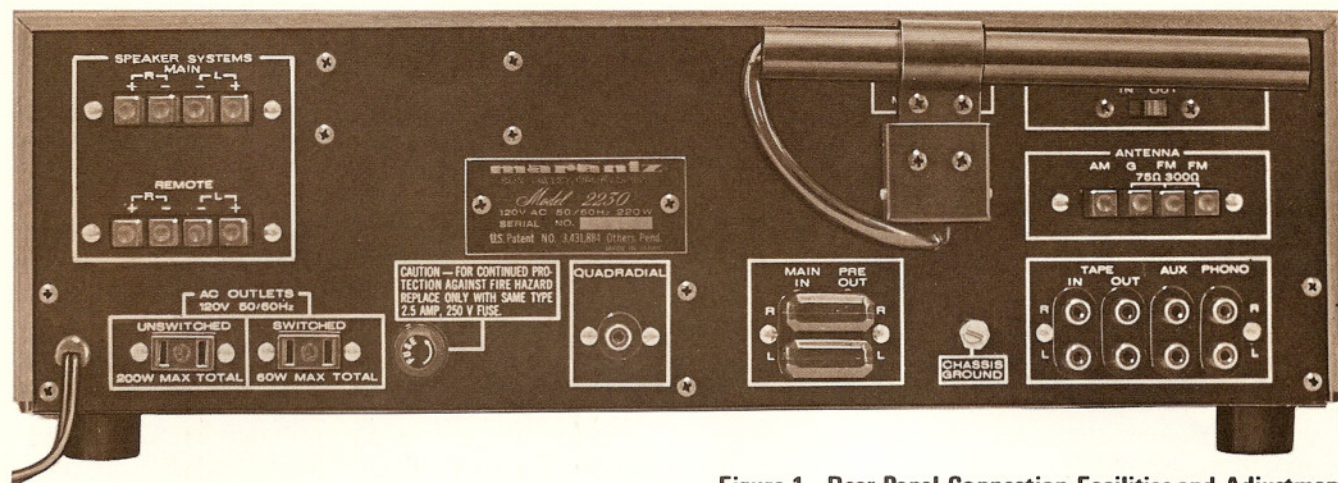

Figure 1. Rear Panel Connection Facilities and Adjustments

## PREPARATION FOR USE

### REAR PANEL CONNECTIONS

All signal connections to the Model 2230, with the exception of the FM antenna and loudspeakers, should be made with shielded audio cables. Figure 1 shows the location of input and output jacks on the rear panel. These jacks are for "permanent" connections. Front panel jacks and their use will be discussed later. The rear panel signal connections are arranged in stereo pairs. To avoid confusion, connect one cable at a time between the 2230 and the other components of your system. In this way, you will avoid cross-connecting channels or confusing signal sources with destinations.

### PHONO

The phono jacks are intended for use with magnetic phono cartridges requiring a standard 47,000-ohm resistive load. If hum is heard when playing records, it is usually evidence of improper grounding or shielding of the record player or its connections. Try reversing the polarity of the turntable's power plug. If this is ineffective, connect a separate ground wire from the turntable or record changer frame to the **CHASSIS GROUND** binding posts of the Model 2230. If the tone arm is mounted on a wood panel or is otherwise insulated from the turntable frame, connect the tone arm mounting base to the grounding wire with a short wire. If the two pairs of signal wires in the arm have a single overall shield, try grounding the shield instead of the arm

itself. Keep the two **PHONO** connecting cables and the grounding wires close together to minimize "ground loops."

### TAPE IN

The pair of **TAPE IN** jacks serve two purposes:

1. With the selector switch in "TAPE" position, signals can be played from a tape recorder set for playback mode of operation. This permits playing the tape source stereophonically or monophonically as indicated by position of **MONO** pushswitch.
2. With the selector switch in any other position, and while your tape recorder is recording, you can monitor the resulting tape quality by depressing the **TAPE MONITOR** pushswitch. This presumes that your recorder is equipped with separate record and playback heads and separate record and playback electronics.

### TAPE OUT

Connecting these jacks to the line or "radio" inputs of a tape recorder permits recording from the program source indicated by the selector switch. The signals available at this pair of jacks are not affected by the **balance, volume, treble, mid, bass, LOW FILTER, Hi FILTER, LOUDNESS** and **MONO** pushswitches on the front panel.

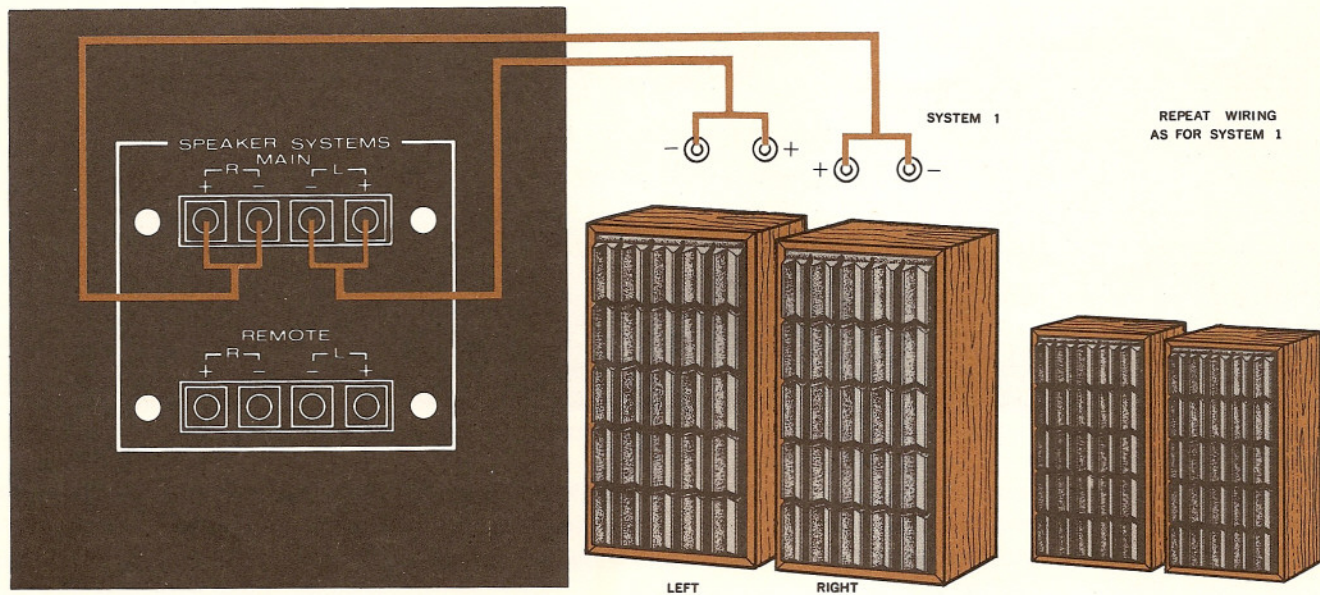

Figure 2. Loudspeaker System Connections

## AUXILIARY

High level **AUX** input jacks are for miscellaneous sources such as extra tape players with self-contained playback preamplifiers, phono cartridges with RIAA-equalized high-level output, additional tuners and/or receivers, TV sound outputs, and other external components.

## QUADRADIAL

In anticipation of the coming of 4-channel stereo broadcasting, your Model 2230 is equipped with an output **QUADRADIAL** jack. The signal available at this jack is the unequalized, buffered output of the FM discriminator. Its level, frequency response characteristic and output impedance are ideal to drive any 4-channel adaptor. This jack can also be used as a simple white noise generator for frequency response check of loudspeakers or amplifiers, with the Model 2230 in FM mode and tuned off from any FM signal.

## MAIN IN and PRE OUT

Connections from the Model 2230 preamplifier outputs to the power amplifier inputs are performed externally. Special jumper plugs normally interconnect these **MAIN IN** and **PRE OUT** jacks. Removing these two special jumper plugs allows you to use your 2230 as an independent basic stereo amplifier and/or an independent stereo control center. Be sure to replace the jumper plugs between the **MAIN IN** and **PRE OUT** jacks for normal operation.

## LOUDSPEAKER SYSTEMS

The **SPEAKER SYSTEMS** terminals on the rear panel will accommodate two stereo pairs of loudspeaker systems of rated impedance between 4 ohms and 16 ohms. When using only one stereo pair of loudspeakers, connect them to the **MAIN** terminals. The **REMOTE** terminals are for a second stereo pair of loudspeakers.

Selection of loudspeaker systems is made with the **MAIN-SPKR-REMOTE** pushswitches on the front panel.

Use caution when connecting your Model 2230 to a loudspeaker with built-in power supply such as an electro-static loudspeaker. The "common" connection terminal of such a speaker may be capacitively grounded through its power supply. Make sure the **GROUND** terminals of the Model 2230 are connected to the "common" terminals of such loudspeaker system.

Ordinary #18-gauge, 2-conductor lamp cord ("zipcord") may be used for normal distances (to about 25 feet) between your 2230 Receiver and your loudspeakers. For longer lengths, #16-gauge, or heavier wire should be used to ensure optimum speaker performance.

When connecting a stereo pair of loudspeakers, it is important to ensure correct relative phasing (polarity). When using identical loudspeakers, simply code one wire of each pair at both ends with a knot, tape, etc.

(Note: Close inspection of standard zipcord will reveal some form of coding on the insulation, e.g., ridge or groove on one edge, one of the wires may be "silver" while the other is bare copper.) Coded wires help insure identical connections for each channel.

For each channel, the coded wire can be connected between the "common" terminal of your loudspeaker and the **GROUND** terminal of the amplifier channel. The remaining uncoded wire is then connected between the remaining loudspeaker and amplifier terminals. This insures correct polarity or phasing of identical loudspeakers.

If there is any doubt about phasing of loudspeaker pairs, or if they are not identical loudspeakers, a simple listening test can verify correct phasing. With program signals fed to both channels, and with the **MONO** pushswitch depressed, the sound should appear to originate at a point midway between the loudspeakers, with the **balance** control centered. As the **balance** control is turned away from the center position, the sound source should appear to move toward one of the loudspeakers. Room acoustics can sometimes make this test ambiguous or confusing. If so, temporarily move the loudspeakers as close together as possible. Then set the controls for balanced **MONO** operation and listen to program material with strong bass passages. Reverse the wires to one of the loudspeakers and listen to the same passage again. If there is noticeably less bass with this reversed connection, change the connections back to the original arrangement. If there is noticeably more bass, leave the wires connected in reverse.

These phasing procedures should be used with each stereo pair of loudspeakers, whether **MAIN** or **REMOTE**. If both pairs of loudspeakers are used in the same listening area, ensure that the **MAIN** pair is also "in phase" with the **REMOTE** pair.

#### CAUTION:

**NEVER DIRECTLY CONNECT THE LOUDSPEAKER TERMINALS OF ONE CHANNEL IN PARALLEL WITH THOSE OF ANY OTHER. ANY RESULTING DAMAGE IS NOT COVERED UNDER WARRANTY.**

#### FM ANTENNA

The best FM reception is obtained with a Log-Periodic type antenna, mounted on a good quality rotor system. For fringe areas, Marantz recommends a Log-Periodic antenna with six or more elements designed expressly for FM reception. For minimum local noise and multipath pickup by the lead-in wires, use a balanced and

shielded 300-ohm cable. (An unshielded lead-in wire can act as an omnidirectional antenna, and can cancel the directional benefits of your antenna.) Low-loss 300-ohm shielded cable consists of two inner conductors plus an outer shield and insulating jacket. This type of shielded cable effectively prevents the lead-in from contributing multipath distortion.

For rural areas, it is recommended that a local dealer be consulted about antenna installation and lightning arrestor protection. Master antenna system are not recommended for use with your Model 2230; such systems are usually designed expressly for television reception and frequently suppress FM signals before distribution. In addition, master antenna systems often severely limit good quality FM reception.

Where outdoor antennas are prohibited or inconvenient, use a simple form of 300-ohm, TV "rabbit ear" antenna or the simple ribbon-type folded dipole antenna supplied with the Model 2230. Both are practical and will give satisfactory results in primary signal areas. Your Model 2230 Receiver will accept either a 75-ohm or 300-ohm antenna. (See diagram Figure 3.) The 300-ohm antenna cable should be connected to the two terminals marked **FM** on the **ANTENNA** terminal. When using 75-ohm coaxial antenna cable, connect its shield to the "**G**" (**GROUND**) terminal, and its inner or center conductor to either of the **FM** terminals.

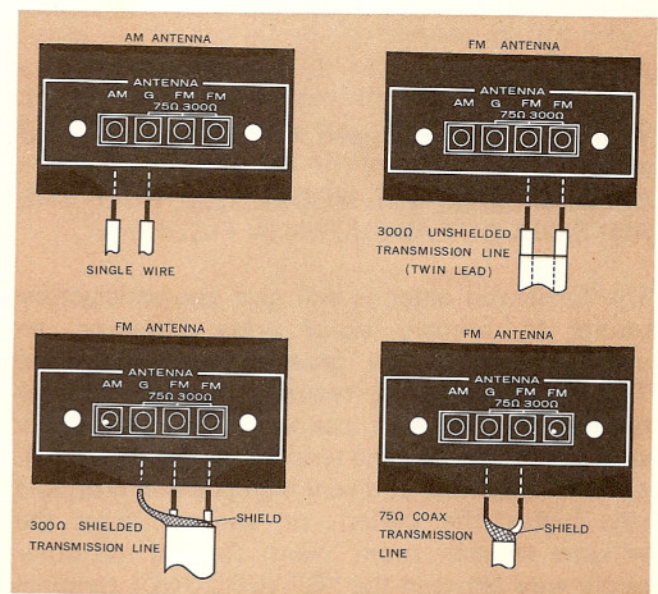

Figure 3. FM/AM Antenna Connection

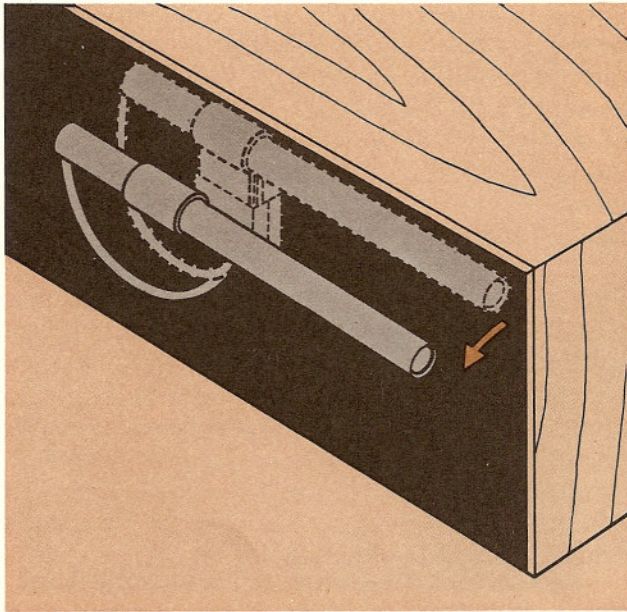

Figure 4. AM Ferrite-rod Antenna

## ANTENNA ATTENUATOR

The **ANTENNA ATTENUATOR** can be switched into or out of the antenna circuit. Use the **ANTENNA ATTENUATOR** switch in the "IN" position only when overloading is apparent from reception of one station at several points of the dial and is affecting reception of a desired station. Overloading may also cause severe distortion which will not disappear with proper antenna orientation. (Note: With the **ANTENNA ATTENUATOR** switch "IN", the FM sensitivity and the number of stations that can be received are greatly reduced.)

## AM ANTENNA

Your Receiver is equipped with an AM ferrite-rod antenna.

**BEFORE USING THE MODEL 2230, PULL THE ANTENNA OUT AS SHOWN IN FIGURE 4.**

The ferrite-rod antenna will give you satisfactory results to primary signal areas. However, an outdoor antenna will provide better reception. Two single wires are required to make an AM outdoor antenna. First, connect one end of a single wire to the AM antenna terminal on the rear panel, and the other end at a very high position outdoors (the higher the better), or swing it from the window of your room. Next, connect the other single wire between the "G" (GROUND) terminal of your Model 2230 and an earth ground (such as a water pipe).

## CONNECTION TO AC OUTLET

With the front panel power pushswitch "out," plug the line cord into an electrical outlet supplying the proper voltage. **CAUTION: DO NOT PLUG YOUR MODEL 2230 INTO A DC OUTLET. SINCE SERIOUS DAMAGE WILL OCCUR.**

## CONVENIENCE OUTLET

One **UNSWITCHED** and one **SWITCHED AC OUTLET** are provided on the rear panel for powering associated components of your system (tape recorder, record player, etc.).

## SIMPLIFIED OPERATING PROCEDURE

When operating the Model 2230 Stereo Receiver for the first time, follow these simple directions. Later, full advantage can be taken of its versatility with the remaining controls and pushswitches.

Step 1. Connect the FM antenna to the appropriate terminals on the rear panel.

Step 2. Connect the speakers to the **MAIN** speaker terminals.

Step 3. Check that all pushswitches are in the "out" position. Pushswitches in the "in" position should be depressed for releasing to the "out" position.

Step 4. Turn the **volume** control all the way to the left (counter clockwise) and set the **balance** control in mid-position (pointer to dot at 12 o'clock).

Step 5. Rotate **treble**, **mid**, and **bass** controls to the 12 o'clock position (each pair of pointers to dot).

Step 6. Set **MAIN** Speaker pushswitch "in," and **REMOTE** "out" (assuming your loudspeakers are connected to the **MAIN** amplifier terminals).

Step 7. Turn on system power by depressing the **power** switch.

Step 8. Select the desired program source by setting the **selector** switch to the appropriate



position. If FM or AM is selected, rotate the Gyro-Touch TUNING knob until the desired station is tuned. Adjust the **volume** control for comfortable listening volume.

The tuner section of the Model 2230 is equipped with electronically triggered circuits which automatically mute interstation noise and automatically switch to the proper mode of operation for stereo and monophonic FM broadcasts. In addition, the STEREO indicator light automatically indicates a stereo broadcast.

## TUNING METERS

The Model 2230 is equipped with a SIGNAL STRENGTH meter.

The SIGNAL STRENGTH Meter indicates the signal strength of any AM or FM broadcast.

## TUNING

**AM:** For optimum AM reception, tune to the selected station. Then rotate the tuning knob slightly back and forth until the maximum reading is obtained on the SIGNAL STRENGTH Meter.

**FM:** Switch the **selector** to "FM" and tune to the desired station. Then slowly rotate the tuning knob slightly back and forth until maximum reading is obtained on the SIGNAL STRENGTH Meter.

## MONO SWITCH

Depressing the **MONO** pushswitch will convert all input signals to the monophonic mode excluding signals at the RECORDING OUTPUT and TAPE dubbing jacks.

While playing a single channel source such as TV or AM, depress the **MONO** pushswitch to feed the signal through both channels of the 2230.

When playing a monophonic phonograph record, use this pushswitch to suppress rumble, common mode noise and pincheffect distortion.

## TAPE MONITOR SWITCH

When this pushswitch is "out," the program being recorded and heard is determined by the setting of the **selector** switch. With the **TAPE MONITOR** pushswitch "in," the amplifier input connections are switched to the output of the tape recorder without affecting the signal presented to the tape recorder's input, thus allowing you to listen to the

signal being recorded before and after recording. This switch is also known as the TAPE-SOURCE switch.

## LOUDNESS SWITCH

For more pleasing tonal balance at low level listening, the bass and treble should be boosted. With the **LOUDNESS** switch depressed, the bass and treble are automatically boosted at low level listening and this tonal balance maintained.

## LOW FILTER SWITCH

The low frequency filter can be used to reduce turntable rumble and low frequency noise. It will also, however, slightly attenuate program material, and should therefore be used judiciously. The "out" position switches the filter out of the circuits.

## HI FILTER SWITCH

AM radio reception is sometimes subject to a high pitched interference "whistle" from a nearby adjacent AM channel. The high frequency filter will suppress this interference, the "scratchy" noise from phonograph records, and tape "hiss." The filter will also, however, slightly attenuate high frequency program material. The "out" position switches the filter out of the circuits.

## MUTING SWITCH AND LEVEL CONTROL

When tuning to FM broadcasts with the **MUTING** switch in its "in" position, the muting circuit will eliminate interstation noise. The muting threshold can be varied by rotation the **MUTING LEVEL** control on the rear panel. To prevent muting very weak stations along with the noise, the muting function may be turned off by releasing the **MUTING** pushswitch to "out" position, and thus switching all muting out of the FM circuits.



Figure 5. Front Panel Controls and Jacks

## MAIN CONTROLS AND SWITCHES

### SELECTOR SWITCH

The **selector** switch selects the program source for listening or recording. If a tape recorder's playback output has been connected to the **TAPE IN** jacks on the rear panel, you can select tape listening by rotating the **selector** switch to the "TAPE" position (with the **TAPE MONITOR** pushswitch in the "out" position).

### BALANCE CONTROL

This control alters simultaneously the output level of both channels. As the knob is turned away from the normal 12 o'clock position, it decreases the level in one channel, while it increases the level in the other channel. (Because the balance control knob has been set for precise electrical balance when the pointer is at the indicator dot at the 12 o'clock position, there may be slightly greater mechanical rotation off center in one direction than in the other.)

### VOLUME CONTROL

This is a dual control which maintains stereo balance at all normal settings. It controls the level of both output channels simultaneously and has no effect on the recording outputs.

### BASS, MID AND TREBLE CONTROLS

These controls are used to adjust the tonal balance of program material to suit your individual listening preference.

### MAIN-SPKR-REMOTE SWITCH

These switches select the loudspeaker terminals to which audio power is fed. Either the **MAIN** or the **REMOTE** stereo pair of loudspeakers may be operated individually, or simultaneously if both switches are depressed. When the two **MAIN-SPKR-REMOTE** switches are in the normal "out" position, all loudspeaker terminals are internally disconnected from the power amplifier section. The signal at the headphones jack is not affected by the **MAIN-SPKR-REMOTE** switches. The "out" position allows "private listening" when stereo headphones are used.

## FRONT PANEL JACKS

### DUBBING OUT

This output is internally connected in parallel with the **TAPE OUT** jacks on the rear panel. Thus, any signals available at the rear panel jacks are simultaneously available at the front panel. You can connect the recording inputs of an external recorder to this jack, using a standard 3-conductor plug. Plugs of this type have an insulated tip, an insulated ring, and a sleeve for common return or ground. The tip of the plug receives the left channel of a program, and the ring receives the right channel (see Figure 6).

### DUBBING IN

This jack has a built-in switch which automatically disconnects the rear panel **TAPE IN** jacks when you insert a standard 3-conductor phone plug. It is intended to receive the playback outputs of an external tape recorder.

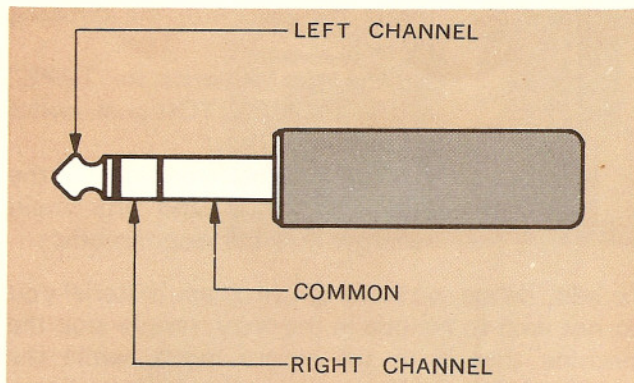

Figure 6. Stereophone Plug

## STEREOPHONES

This jack accepts the standard 3-conductor phone plug used on standard stereo headphones (see Figure 6). It is internally connected to the power amplifier section through isolation resistors to provide adequate sound level with popular low impedance headphones as well as with high impedance ones. Two or more sets of headphones may be used with the aid of "Y" connectors. The headphone jack output is not affected by the MAIN-SPKR-REMOTE switches.

## SOME SUGGESTIONS ON USING TAPE RECORDERS WITH YOUR MODEL 2230

There are several ways to connect and operate tape recorders with your receiver. To avoid confusion in the following discussion, reference to "tape monitoring" assumes that the recorder is equipped with separate record and playback heads and separate record and playback preamplifiers. To further simplify this discussion, a tape recorder normally connected to the rear panel facilities will be referred to as the "main" recorder. A separate recorder normally connected to the front panel jacks will be referred to as the "external" recorder. This general arrangement is illustrated in Figure 7.

## RECORDING AND PLAYBACK

The simplest system involves only one tape recorder, whose inputs are connected to the TAPE OUT jacks (on the rear panel) and whose playback outputs are connected to the TAPE IN jacks. An equally simple arrangement using the front panel facilities involves connecting the line inputs to the dubbing OUT jack and the playback outputs to the dubbing IN jack.

## RECORDING

To make a recording, set the selector switch to the desired program source and put the recorder into the "record" mode of operation. With the TAPE MONITOR pushswitch in the "out" position, the original program source will be heard. By depressing the TAPE MONITOR pushswitch (monitor), the "results" of the recording while it is in progress, will be heard. A word of caution: With the tape recorder in the record mode, be careful not to place the selector switch in the "TAPE" position when the TAPE MONITOR pushswitch is "out." Doing this feeds the recorder's output signals back to its input terminals, establishing a reverberating loop. If the recorder's playback level happens to be set higher than its record level, the resulting echo or "howl" will rapidly increase in volume level. No harm will be done to the recorder or the receiver, but the audible effect from the loudspeakers can be annoying.

## PLAYBACK

To listen to a tape already recorded, put the recorder in the playback mode of operation and turn the selector switch to "TAPE". When playing tape on an external recorder, the recorder's playback outputs should be connected to the dubbing IN jack on the front panel. When playing a tape on the main recorder, make sure nothing is plugged into the dubbing IN jack, otherwise the main recorder's playback outputs will be internally disconnected in the receiver.

## MAKING TWO RECORDINGS SIMULTANEOUSLY

This can be done by connecting two tape recorders to the receiver, as shown in Figure 7. To monitor the main recorder, pull the plug out of the dubbing IN jack and depress the TAPE MONITOR pushswitch.

## RECORDING A LONG-DURATION PROGRAM

With two tape recorders connected to the Model 2230 as shown in Figure 7, a continuous recording can be made without losing parts of the program during reel changes. For example, with the selector switch set to the desired program source, and the TAPE MONITOR pushswitch in the "out" position, start the recording on the main recorder, then prepare the external recorder to begin recording before the main recorder is about to run out of tape. As soon as the external recorder is started, ample time will be available to reload the main recorder in preparation for further recording. This process can be repeated indefinitely with both

machines. At any time during the recording session, the recording can be monitored by depressing the **TAPE MONITOR** pushswitch.

**REMEMBER:** Disconnect the plug from the **dubbing IN** jack to monitor the main recorder. Insert the plug to monitor the external recorder.

### COPYING AND EDITING

Using the input/output and control facilities of the Model 2230, and two tape recorders, you can copy and edit tapes from one machine to the other. The general arrangement of equipment for copying and editing is illustrated in Figure 7.

To copy from the main recorder to the external recorder:

- Step 1. Disconnect the plug from the **dubbing In** jack.
- Step 2. Set the **selector** switch to "TAPE" and **TAPE MONITOR** pushswitch to "out" position.
- Step 3. Put the main recorder into the playback mode and the external recorder into the record mode.

To Copy from the external recorder to the main recorder:

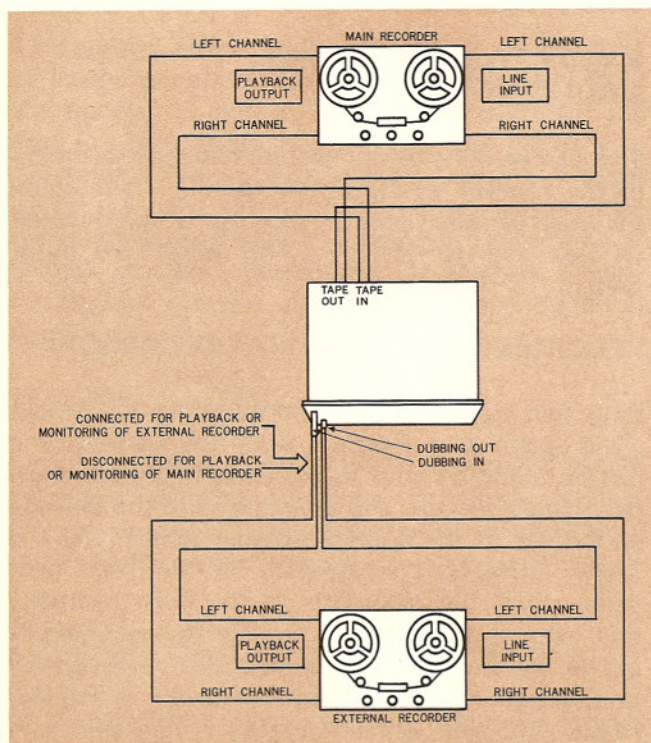

Figure 7. Arrangement of Two Tape Recorder

- Step 1. Insert the plug into the **dubbing IN** jack.
- Step 2. Set the **selector** switch to "TAPE" and **TAPE MONITOR** push-switch to "out" position.
- Step 3. Put the external recorder into the playback mode and the main recorder into the record mode.

To edit, delete, or leave out program material you do not wish to include in the copy, simply stop the machine that is in the record mode, while the unwanted program material is playing. Some machines are equipped with a convenient "pause" control for this purpose.

### CONVERTING YOUR STEREO SYSTEM TO 4-CHANNEL

In the future, it is conceivable that you may decide to expand your stereo system into a four-channel sound system. Marantz simplifies this conversion by offering the Model 2440 Adaptor Amplifier, which has been specifically designed and engineered to add the dimension of four-channel sound to your stereo receiver. It contains a 40 watt continuous (RMS) Stereo amplifier and incorporates all the technology, required to convert your present Marantz stereo receiver into a four-channel sound system.

Features of the Marantz Model 2440 Quadradial 4 Adaptor Amplifier include:

- Ready to accept an external CD-4 disc demodulator.
- SQ pocket for plugging in Marantz' SQA-1 and SQA-2 decoders and all future matrix decoders.
- Complete provisions for accepting any four-channel tape recorder.
- Master volume control for all four channels.
- Four-channel finger-tip balance controls.
- Complete provisions for switching both MAIN and REMOTE four-channel speaker systems.
- Bass and treble controls for the rear channels.
- Headphone jack for the rear channels.
- Accepts Marantz' Model RC-4 remote control unit.

But, that's not all — the Model 2440 also incorporates Marantz' exclusive VARI-MATRIX feature to synthesize four-channel sound from any stereo source. With the Model 2440, all you require is an additional pair of speakers for the rear channels. Further information can be obtained from your local Marantz dealer.

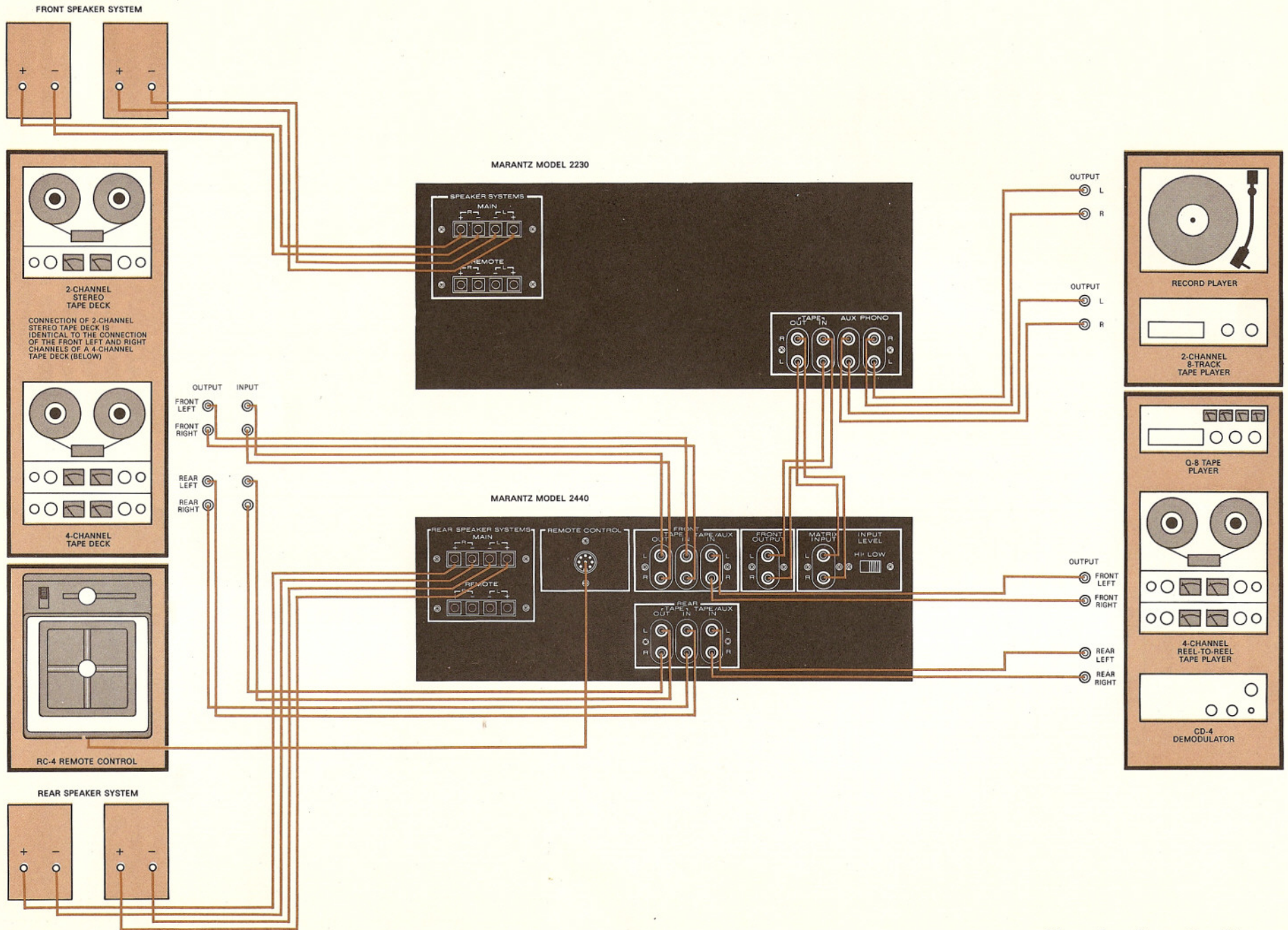

Figure 8. Connection Diagram

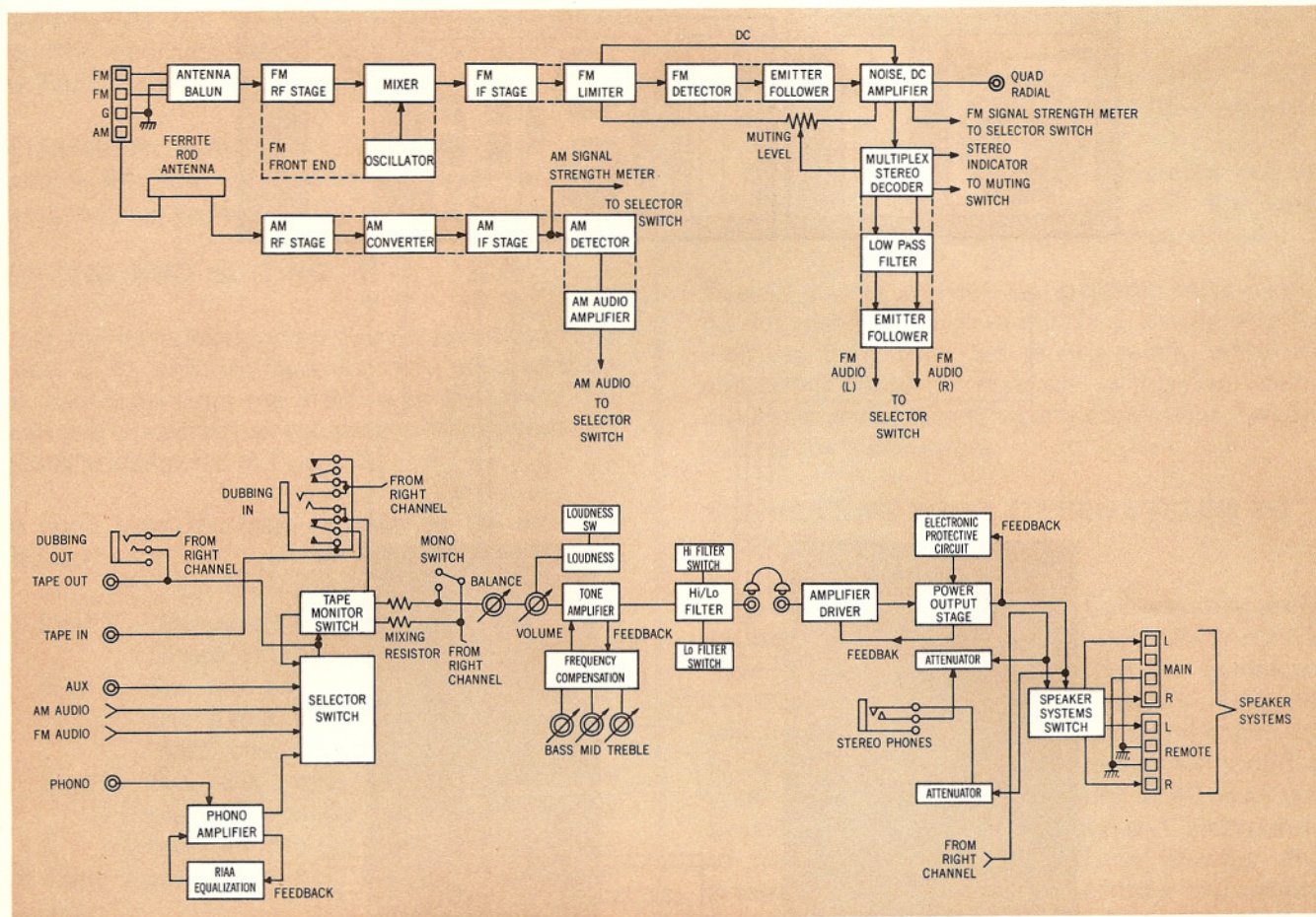

Figure 9. Functional Block Diagram

## TECHNICAL DESCRIPTION

### GENERAL

Figure 9 is a block diagram of the Model 2230 Receiver showing the main functional elements and input and output signal routing. Each AM and FM front end has its own IF stages. For clarity, only the left audio channel is shown; the right audio channel is identical. The **MONO** switch is common to both channels. All audio controls are ganged, to their counterparts in the right channel. The left channel half of the front panel **dubbing IN** and **dubbing OUT** jacks are shown interconnected in this diagram. The right channel of each jack is wired to the same circuit point in the right channel.

## FUNCTIONAL DESCRIPTION

### FRONT END

FM antenna signals are applied through a balun transformer and the antenna **ATTENUATOR** switch to the antenna coil which drives a field-effect transistor RF amplifier. When the **ATTENUATOR** pushswitch is placed in the "out" position the attenuator circuit is cut off the FM signals are directly fed to the FM antenna coil. With **ATTENUATOR** pushswitch placed in the "IN" position, the signals are attenuated about 20dB by the attenuator circuit, then fed to the antenna coil. The signals from the RF amplifier are fed through the double-tuned RF tank circuit to the FET Mixer stage, which is also fed by the signal

generated by a local oscillator. This mixer converts the carrier frequency to the 10.7MHz intermediate frequency. Careful attention to its thermal and electrical characteristics has minimized drift, thus obviating the necessity for AFC. The 10.7MHz converted signal is then fed to a phaseliner ceramic IF filter, followed by an IC limiter. It is then, in turn, processed through an FM discriminator. The output of the FM discriminator is fed to a buffer amplifier which then drives the demodulator.

## IF STAGES

The IF section consists of four transistors and six ceramic filters. The characteristics of this filter are ideal in that the 200KHz passband is phase-linear, with sharp cut-off slopes. Its exceptional phase linearity assures the elimination of a major source of high-frequency distortion and a loss of stereo separation. The sharp cut-off slopes provide improved selectivity, permitting reception of closely spaced channels.

## LIMITER

The Model 2230 utilizes multi-stages (transistor plus limiter diodes and IC) limiter amplifier with a very small dynamic symmetrical aperture, eliminating the need for AGC circuit which introduces low frequency distortion. Undesirable Amplitude Modulation (AM signals, AM noise, AM distortion) are removed from the IF signal within the limiter.

## FM STEREO DEMODULATOR

The composite audio signal from the buffer amplifier is fed into the multiplex stereo demodulator circuit consisting of 11 transistors and 6 diodes. The 19kHz pilot signal contained in the composite audio signal is doubled into 38kHz after two-stage amplification and then the 38kHz signal is further amplified to the level necessary to drive the diode switching circuit. The composite audio signal is split into the right and left channels by the 38kHz switching signal in the diode matrix circuit. The right and left channel audio signals are processed in the crosstalk cancelling circuit which utilizes complementary configuration with NPN and PNP transistors. The audio signals are then fed into the selector switch and the TAPE OUT jacks from the low pass filters for filtering undesired 19-and 38kHz components and emitter followers for low impedance output.

The stereo demodulator circuit has been designed with the de-emphasis network to provide flat

frequency response up to 15kHz. One hundred percent air-tight coils and filters are incorporated in the stereo demodulator circuit for improved stability and reliability with good stereo separation and frequency response.

The multiplex stereo demodulator circuit has been provided with an automatic stereo/monaural switching circuit. The circuit checks the input signal intensity and activates the stereo demodulator circuit and the stereo indicator lamp automatically only when the input signal is powerful enough to provide good quality stereo reception. When the input signal strength is below the threshold level, the FM stereo broadcast is processed as monaural signal and improved signal-to-noise ratio is obtained in this mode of operation.

## MUTING CIRCUIT

In the absence of an FM carrier, all FM receivers produce a peculiar noise. The muting circuit eliminates this noise, providing you with noise-free tuning from station-to-station.

A muting circuit, consisting of a two-transistor noise amplifier and a three-transistor (including one FET) switching circuit, has been incorporated in the Model 2230. The muting circuit perfectly mutes out all the interstation noise and also completely mutes out the side slope spurious response of the unit. The circuit has been designed to minimize annoying "pop" noise for velvet smooth tune in and tune out.

## AM TUNER

The AM tuner portion of the Model 2230 has been provided with a tuned RF amplifier incorporating a three-section variable capacitor for improved spurious response ratio.

The ceramic filter utilized in the AM IF amplifier comes with higher selectivity and wider bandwidth for interference-free hi-fi AM reception.

Following the AM IF amplifier, the AM detector recovers the audio modulation and provides this signal to the selector switch.

The AM tuner and IF amplifier are subjected to the action of an effective automatic volume control circuit which maintains constant the level of all stations in the AM band.

## SELECTOR SWITCH

Your Model 2230 has the capability to operate from a variety of program sources, e.g., AM or FM broadcasts, turntable (PHONO), tape recorders (TAPE) or any other source capable of providing 100 millivolts output level (AUX). The selector switch connects the inputs of the TONE amplifiers

selectively to the desired source.

## TAPE SIGNALS

With the exception of tape input, all high-level inputs are fed directly to the selector switch. Tape input is routed through the front panel **dubbing IN** jack to a section of the **TAPE MONITOR** switch. The **dubbing IN** jack is a three-conductor stereo jack which has two built-in switches, one for each channel. Normally, these switches are closed, allowing the tape input signals from the **TAPE IN** jack on the rear panel to be fed to the **TAPE MONITOR** switch. When a plug is inserted in the **dubbing IN** jack, the switches are opened, disconnecting the **TAPE IN** jacks and allowing the signal from the **dubbing IN** jack to reach the **TAPE MONITOR** switch. Thus only one tape recorder at a time can feed playback signals into the Model 2230.

## TAPE MONITOR SWITCH

When the **TAPE MONITOR** pushswitch is in the "out" position tape input signals from the **TAPE IN** jacks on the rear panel or **dubbing IN** jack on the front panel are fed to the selector switch. When the **TAPE MONITOR** is depressed, the output of the selector switch is disconnected from the balance control and the tape input signals from the **TAPE IN** or **dubbing IN** jacks feed the balance control directly.

## PHONO SIGNALS

Phono signals of up to 100 millivolts can be handled without overloading. The RIAA equalization network provides precise equalization and sets the voltage gain of the phono preamplifier to 40dB (at 1,000Hz).

## MONO FUNCTIONS

When the **MONO** pushswitch is in the "in" position, the two channels are connected together through mixing resistors. In addition, the left and right channel tape input signals are connected together through a similar resistor network. This facility allows all inputs to be converted to the monophonic mode.

## CONTROL CIRCUITS

The control circuits portion of the Model 2230 consists of the balance, volume, bass, mid, treble, **Hi FILTER**; and **LOW FILTER** controls. All controls affect the left and right channels simultaneously.

With the controls set for flat response and volume control at maximum, the over-all voltage gain from any high-level input to the loudspeaker terminals is approximately 38dB.

## BALANCE CONTROL

The balance control is a wide-range control which permits attenuation of each channel to cutoff. The change of attenuation in each channel as the control is turned away from center has been designed to maintain total apparent loudness from both channels. This feature makes it a true stereo balance control.

## VOLUME CONTROL

The volume control attenuates both channels simultaneously and maintains tracking to within 3dB at any point of attenuation to -50dB from maximum. Since the control is situated at the input of the tone amplifier, there is no possibility of overloading the amplifier stages under maximum rated output conditions. Thus, distortion is kept to a minimum. After attenuation by the balance and volume controls, the signal is applied to the tone amplifier.

## TONE AMPLIFIER

The **TONE AMPLIFIER**'s circuitry uses a continuously variable R-C feedback-type configuration.

The signal from the **TONE AMPLIFIER** feeds the hi/low filter circuit when the **Hi FILTER** or the **LOW FILTER** pushswitch is depressed.

## HI-LOW FILTERS

The Hi-Low filters provide 6 dB or fall off per octave.

## GENERAL

Power Requirements . . . 120 V AC 50 to 60 Hz  
At rated output,  
both channels operating . . . . . 220 Watts  
Idling Power (Volume Control at zero) . . . 48 Watts

## Dimensions

Panel Width . . . . . 17 <sup>21</sup>/<sub>64</sub> Inches  
Panel Height . . . . . 5 <sup>25</sup>/<sub>64</sub> Inches  
Depth . . . . . 14 Inches

## Weight

Unit alone . . . . . 28.6lbs  
Packed for shipment . . . . . 38.6lbs



Please Pack the Receiver as Illustrated.

### CAUTION

Please **DO NOT** ship your receiver mounted in its accessory walnut cabinet.

Insure receiver for full value:

Make sure that your correct return address is on shipping label.

Ship via a reputable carrier (**DO NOT USE PARCEL POST**). Be sure to obtain receipt from carrier.

## SERVICE NOTES

### REPAIRS

Only the most competent and qualified service technicians should be allowed to service the Marantz Model 2230 Receiver. The Marantz Company and its warranty station personnel have the knowledge and special equipment needed for the repair and calibration of this precision instrument.

In the event of difficulty, write directly to the factory (to the attention of the **technical service department**) for the name and address of the nearest Marantz warranty or authorized service station. Please include the model and serial number of the unit together with a description of the problem.

If it should ever be necessary to ship the unit to the factory or authorized service station and your receiver is mounted in its accessory walnut cabinet, **ALWAYS REMOVE IT FROM THE CABINET BEFORE PACKING. DO NOT SHIP THE ACCESSORY WALNUT CABINET.** Pack the unit carefully, using the original packing material. If the packing material has been discarded, lost, or damaged, write to the factory (to the attention of the **technical service department**) for new packing material. Carton, fillers, and packing instructions will be shipped to you at a nominal charge.

No receiver should be returned to the factory without an Authorized Return Label which the Marantz Company will supply if the description of difficulties appears to warrant factory service.

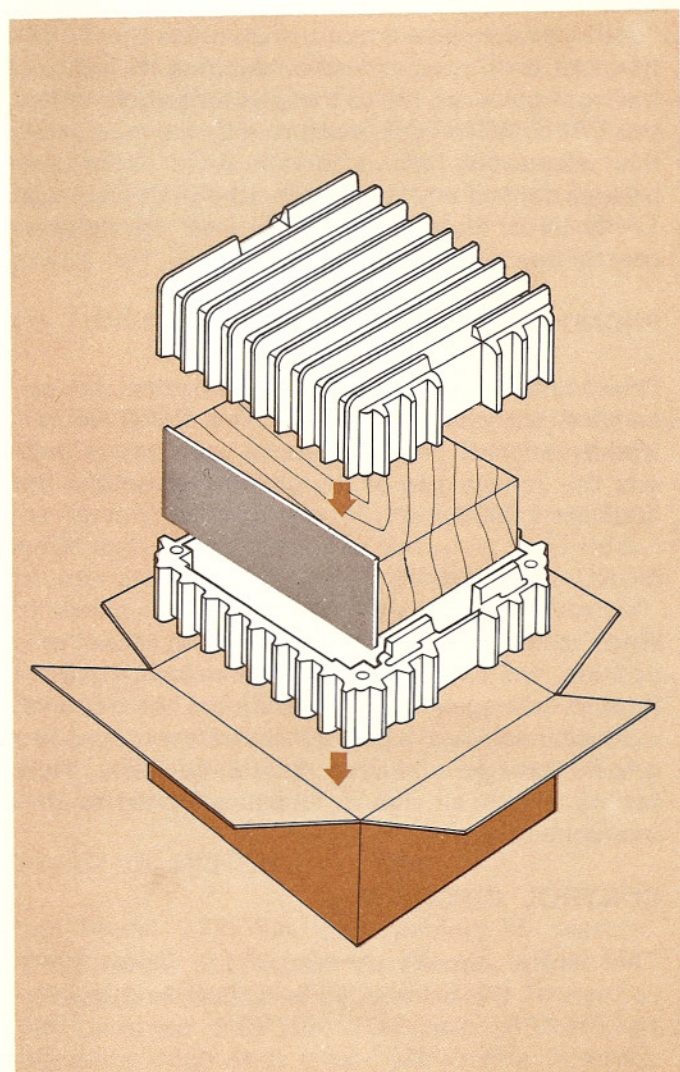

Figure 10. Packing Instructions

The Sound of Marantz  
is the compelling warmth of a Stradivarius.  
It is a dancing flute, a haughty bassoon  
and the plaintive call of a lone French horn.  
The Sound of Marantz is the sound of beauty,  
and Marantz equipment is designed to bring  
you the subtle joy of its delight.  
Wonderful adventures in sound await you  
when you discover that the Sound of Marantz  
is the sound of music at its very best.



**marantz.**