

McIntosh

FM STEREO TUNER

MR65B

TABLE OF CONTENTS

INTRODUCTION.....	1
TECHNICAL DESCRIPTION.....	1
FRONT PANEL INFORMATION.....	3
BACK PANEL INFORMATION.....	5
INSTALLATION.....	6
CONNECTING.....	8
Stereophonic FM Multiplex.....	8
Monophonic FM.....	8
Remote Amplifiers.....	8
Off-The-Air Recording.....	8
Antenna Connections.....	10
OPERATING INSTRUCTIONS.....	11
Stereophonic FM Multiplex.....	11
Monophonic FM.....	11
External Stereo.....	11
ADJUSTMENTS.....	12
Muting Threshold.....	12
FM Signal Strength Meter.....	12
FM Tuning Meter.....	12
Dial Panel Lights.....	13
Output Adjust.....	13
GUARANTEE.....	14

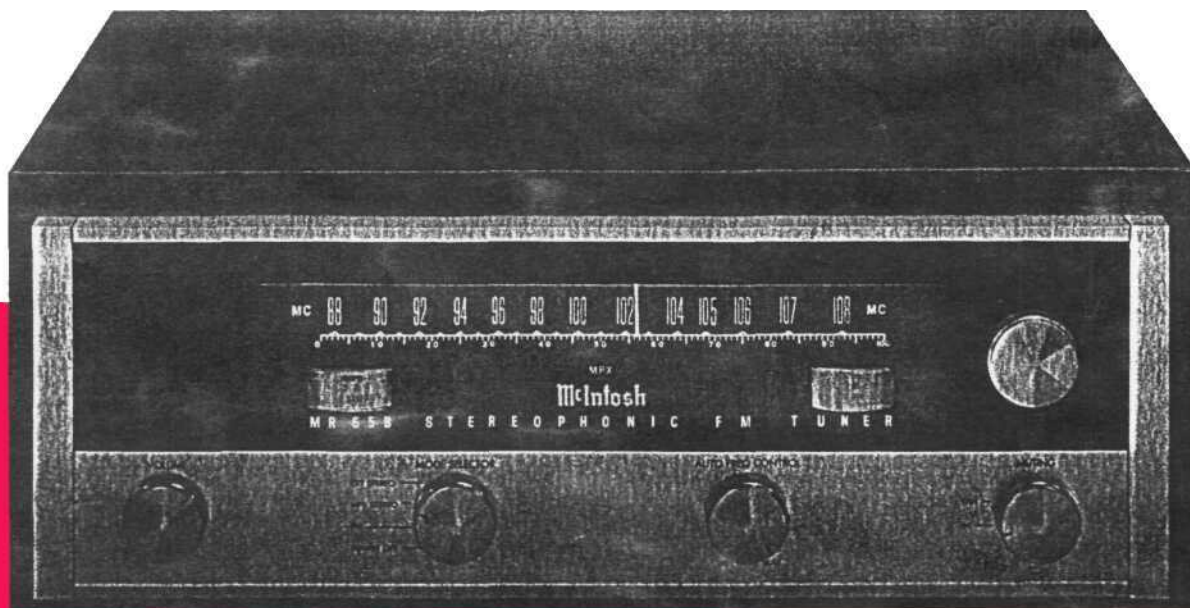

OWNER'S MANUAL

MR65B

MR65B FM STEREO TUNER

INTRODUCTION

The McIntosh Model MR65B is a precision-engineered, sensitive FM multiplex stereo tuner. It offers the finest possible reception of FM monophonic and FM multiplex stereophonic broadcasts. Every desirable feature for your FM listening pleasure is included in the MR65B tuner. It is perfect for use in a stereo music system where nothing less than "THE Best" will do.

Once you have enjoyed the outstanding performance of the MR65B, you will understand why McIntosh products have earned their reputation as "THE Best."

Your McIntosh MR65B tuner will give you years of the finest possible FM reception, and will become a highly valued part of your home music system.

TECHNICAL DESCRIPTION

The MR65B tuner has a 6DS4 high-gain Nuvistor for the first RF amplifier. The Nuvistor (triode) operates into a triode tube to form a cascode amplifier. Careful design of the operating characteristics allows the cascode amplifier to handle a wide dynamic range of signals with excellent signal-to-noise ratio.

A double-tuned RF input circuit combined with the Nuvistor-tube cascode amplifier reduces spurious signals to an extremely low value. Sensitivity is increased to the highest possible rating, while still retaining high selectivity.

A newly developed Automatic Frequency Control (AFC) circuit greatly simplifies tuning. As the tuning knob is moved, the AFC circuit automatically cuts off for sharpest tuning. After the station is tuned in, the AFC circuit gradually comes into operation over a 3 second interval. The AFC action automatically brings the electrical tuning to the correct point for minimum distortion. This automatic tuning repeats its action each time the tuning dial is moved to a different station. The amount of AFC action is fully adjustable with a front panel control.

The AFC circuit is quite unique. It uses a silicon diode in place of a conventional tube. The silicon diode improves the overall AFC performance since it is unaffected by temperature changes, has no warm-up drift and eliminates the chance of tube filament hum. A special temperature-compensated narrow band detector supplies operating signals to the AFC circuit. This insures positive AFC action. The narrow band detector also operates the FM tuning meter amplifier and the ultrasonic muting circuit.

- The McIntosh-developed ultrasonic muting circuit automatically suppresses all interstation noise, including the noises usually heard tuning in and out of a station. Weak or distant stations that don't over-ride the background noise and interference are also suppressed by the muting. A switch on the front panel allows muting to be cut off for listening to these weak and noisy stations. A back panel adjust control is factory-set to the proper muting threshold level.

Three flat-topped response IF amplifiers reject adjacent channel interference. More than adequate gain is provided to operate both limiters on the weakest signals. Two complete limiters are used to insure the best possible signal-to-noise ratio.

A separate wide band detector handles exclusively the audio frequencies for low distortion and wide frequency response.

Both the RF and IF circuits are completely shielded and exceed the FCC requirements for suppression of radiation from the FM oscillator and IF frequencies.

A unique multiplex stereo (MPX) indicator light is included on the front dial panel. The MPX indicator lights whenever the dial pointer crosses a station broadcasting FM multiplex stereo. The indicator uses a special noise-rejecting bridge circuit with two germanium diodes. The indicator lights ONLY on the 19KC carrier present in a multiplex stereo broadcast. It will not light on noise or interference signals.

The MR65B multiplex decoder circuit uses a special peak-switching, self-matrixing detector. Stereo channel separation is maintained at better than 30db.

Two pairs of audio output jacks are on the back panel. One pair of jacks is controlled only by the front panel volume control. The other pair of jacks is controlled only by the back panel output adjust controls. Two stage feedback type preamplifiers on both channels provide low impedance outputs. More than sufficient output volume is available to feed power amplifiers as well as preamplifiers.

A new type of mechanical tuning assembly gives the MR65B an extremely smooth fly-wheel tuning action. The tuning capacitor is driven directly, and in turn drives the pointer. Backlash is practically eliminated with this method of design. A teflon lined pointer carriage and nylon pulleys reduce friction and wear to give an unusually smooth and quiet dial action.

SPECIFICATIONS

Useable Sensitivity

2.5 microvolts at 100% modulation (± 75 KC deviation) for less than 3% total noise and harmonic distortion in accordance with IHFM standards.

Audio Frequency Response

Within $\frac{1}{2}$ db from 20 to 20,000 cycles.

Distortion

Less than 0.5% at 100% modulation ± 75 KC deviation.

Capture Ratio

1.5db at 100% modulation.

Muting

IF injected ultrasonic muting: at least 60db noise reduction between stations.

Oscillator Drift

Less than 25KC with AFC disabled; negligible with AFC in operation.

Image Rejection

Better than 80db at 90MC; better than 70db at 105MC.

Hum

Better than 70db below 100% modulation.

Output

Approximately 2.5 volts; low impedance.

Antenna Inputs

300 ohms balanced; 75 ohms unbalanced.

RF Amplifier

Cascode with 6DS4 Nuvistor in first stage.

IF Amplifiers

Four, with 200KC bandwidth, flat top response

Limiters

Two

Radiation

Substantially below FCC requirements.

Multiplex Channel Separation

Better than 30db at 1000 cycles.

Multiplex Filter

Greater than 48db suppression of 19KC pilot and 38KC carrier.

Multiplex Indicator

Front panel multiplex stereo light activated by 19KC carrier-only.

Multiplex Type

Peak-detecting, self-matrixing detector.

Tube and Semiconductor Complement

1—6DS4 Nuvistor, 1st RF.

1—12AT7, 2nd RF and Mixer.

1—6BN4A, Oscillator.

1—6AU6, 1st IF.

1—6AU6, 2nd IF.

1—6AU6, 3rd IF.

1—6AU6, 4th IF and 1st Limiter.

1—6CS6, 2nd Limiter and Muting.

1—6BN8, Muting Amplifier, Muting Detector, AVC Clamper.

2—6BL8, Left and Right, 1st and 2nd Audio Amplifiers.

1—12AU7, Balanced Tuning Meter Amplifier.

1—6U8, MPX Amplifier, MPX Indicator Control.

- 1-12AU7, MPX Oscillator.
- 1—ST2-275, Voltage Reference.
- 1—MA113 (Transistor), MPX Indicator Lamp Switch.
- 2—Diodes, Wide Band Discriminator
- 2—Diodes, Narrow Band Discriminator.
- 4—Diodes, Balanced MPX Detector.
- 2—Diodes, Balanced Detector for MPX Indicator.
- 2—Rectifiers, High Voltage Power Supply.

Power Consumption

70 watts, 105 to 125 volts, 50 to 60 cycles.

Dimensions

Front panel 15-3/8 inches x 5-1/8 inches; overall depth of chassis behind front panel, 12-3/16 inches; clearance in front of mounting panel including knobs, 1-1/2 inches.

Weight

Chassis only, 22 pounds.
In shipping carton, 31 pounds.

FRONT PANEL INFORMATION

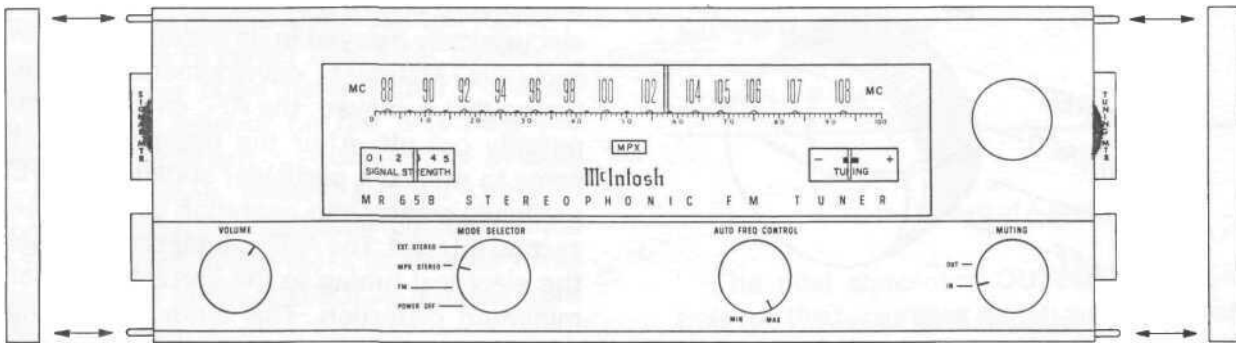

Figure 1. MR65B Front Panel.

TUNING DIAL

The tuning dial is calibrated in both megacycles and a 0-100 logging scale. Tuning back to a particular station is much easier by keeping a record of the exact station location on the logging scale.

METERS



Figure 2. FM Signal Strength Meter.

At the left side of the dial is the FM SIGNAL STRENGTH meter. The amount of meter pointer deflection indicates the relative signal strength of the station being received. Use the signal strength meter to correctly position a directional FM antenna. Maximum meter deflection for a particular station occurs when the antenna is pointed in the direction for best signal pickup.



Figure 3. FM Tuning Meter.

At the right side of the dial is the FM TUNING meter. An FM station is correctly tuned when the meter pointer is within the black area at the center of the meter scale. Both meters can be adjusted for proper zero settings if necessary. (See section titled ADJUSTMENTS.)

MULTIPLEX STEREO INDICATOR

At the center of the tuning dial is the multiplex stereo (MPX) indicator. The indicator lights (red) MPX whenever the dial pointer crosses a station broadcasting multiplex stereo. The indicator lights ONLY on the 19KC multiplex carrier present in a multiplex stereo broadcast. The indicator will NOT light on noise or interference signals.

VOLUME

Controls the output volume level of the tuner at the right hand pair of AUDIO OUTPUT jacks on the back panel. This pair of jacks is marked FRONT PANEL CONTROLLED. The other pair of audio output jacks, located to the left, is not affected by the front panel volume control. The output volume level at these jacks is controlled by the dual concentric OUTPUT ADJ controls to their left. (See section titled ADJUSTMENTS.)

MODE SELECTOR

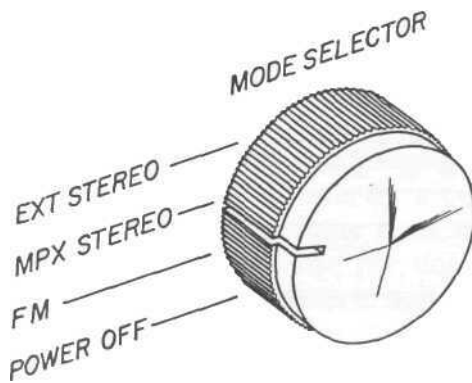

Figure 4. Mode Selector.

Power Off

Turns off the tuner AC power and also turns off the AC outlet on the tuner hack panel.

If a TV antenna is used for FM in the manner described under ANTENNA CONNECTIONS, it will automatically be switched back to the TV set in the POWER OFF position.

FM

Provides monophonic FM at both pairs of left and right channel audio output jacks.

MPX Stereo

Provides FM multiplex stereo at the respective left and right channel audio output jacks.

EXT Stereo

Provides monophonic FM at the RIGHT channel audio output jacks. The back panel EXT STEREO INPUT jack is also connected through the tuner preamplifier to the LEFT channel audio output jacks in this switch position. A monophonic AM tuner, for example, may be connected to the EXT STEREO INPUT for AM-FM stereo reception.

AUTO FREQ CONTROL



Figure 5. Auto Freq Control.

The Automatic Frequency Control (AFC) circuit makes FM tuning easier. It also eliminates the possibility of the tuner drifting off the station. The AFC circuit in the MR65B is electronically delayed in its action. This is an exclusive McIntosh development. As the tuning dial is moved, the AFC circuit is temporarily cut off. After the dial pointer has come to rest on a particular station, the AFC gradually comes into operation over a three second interval. The AFC automatically brings the electrical tuning to the correct point for minimum distortion. This automatic tuning repeats itself each time the tuning dial is moved to a different station.

The degree of AFC action is adjustable with the AUTO FREQ CONTROL. Full left (MIN) position of the control cuts off AFC action. Full right (MAX) position gives maximum AFC action.

Normally, the best tuning occurs with the Auto Freq. Control set at or near MAX position. If several stations are very close together on the dial, or if a desired station is very close to a much stronger station, a lower AFC setting is usually necessary for best tuning.

MUTING

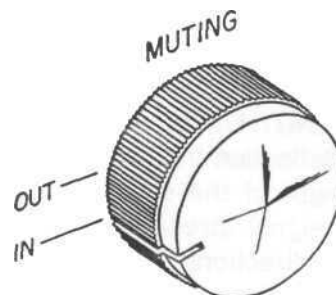

Figure 6. Muting Control.

In

Turns on the McIntosh-developed ultrasonic muting circuit. Ultrasonic muting suppresses all background hiss and noise and noise usually heard when tuning between stations. Weak or distant stations that may not override the noise and interference are also suppressed by the muting.

Out

Turns off the ultrasonic muting to allow conventional FM tuning with inter-station noise present. Use this setting to listen to weak or distant stations that may be mixed with noise or interference.

BACK PANEL INFORMATION

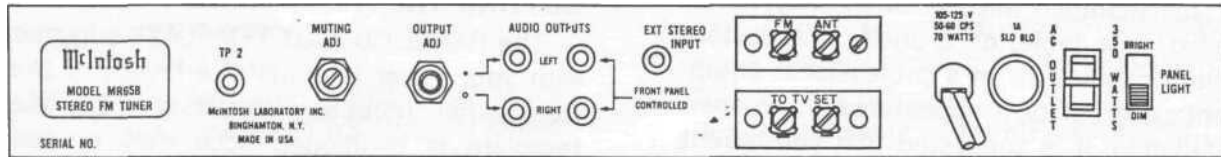

Figure 7. MR65B Back Panel.

TP 2

A test point provided for convenience of tuner circuit alignment. Refer to the MR65B Maintenance Manual for complete alignment procedure and suggested test equipment.

OUTPUT ADJ

Dual concentric control adjusts the output volume levels at the left hand pair of AUDIO OUTPUT jacks. The center shaft adjusts the LEFT channel output, and the outer sleeve adjusts the RIGHT channel output. These output control settings for the left pair of jacks are not affected by the MR65B front panel volume control. (See section titled ADJUSTMENTS.)

MUTING ADJ

Adjusts the operating threshold of the ultrasonic muting circuit. (See MUTING ADJUST under ADJUSTMENTS section.)

AUDIO OUTPUT-LEFT-RIGHT

The left hand pair of AUDIO OUTPUT jacks provides FM signals unaffected by the MR65B front panel volume control. The dual concentric output adjust controls set the volume levels. Use these output jacks to connect the tuner to a stereo control preamplifier which has its own master volume control. This pair of jacks is recommended for McIntosh preamplifiers.

The right hand pair of AUDIO OUTPUT jacks provides FM signals controlled by the MR65B front panel volume control. Use these output jacks to connect to external power amplifiers, tape recorders, or any equipment which requires continuous front panel control of tuner output volume.

EXT STEREO INPUT

Connects through the MR65B left channel preamplifier and appears at the left channel audio outputs when the MODE SELECTOR is set to EXT STEREO. The MR65B monophonic FM output appears at the right channel audio output jacks when the MODE SELECTOR is set to EXT STEREO.

An AM tuner may be connected to the EXT STEREO INPUT for reception of AM-FM stereo in the EXT STEREO setting.

FM ANT

Terminals for connecting an FM antenna to the MR65B.

TO TV SET

Terminals for connecting TV set antenna leads when a VHF TV Antenna is used for both the MR65B and a TV set. The antenna is automatically switched to the MR65B when the MODE SELECTOR switch turns the MR65B to any of the "ON" positions. The

antenna is switched back to the TV set when the MR65B MODE SELECTOR is turned to POWER OFF.

1A SLO BLO FUSE

A 1 amp "Slo-Blo" fuse protects the tuner circuits. This fuse does not protect additional equipment connected to the back panel AC outlet.

AC OUTLET

Provides 117 volt AC power up to 350 watts maximum for additional equipment such as turntables or other tuners. This outlet is not fused and turns on and off with the front panel MODE SELECTOR switch.

PANEL LIGHT SWITCH

Adjusts the front panel lights to bright or dim.

INSTALLATION

The McIntosh MR65B tuner may be installed on a table, on a shelf, in a custom built-in cabinet, or in a professional equipment rack. For best appearance in an open installation, it is suggested that you mount the MR65B in the attractive McIntosh Model L66 finished wood cabinet.

The MR65B may be mounted in panels up to 1 inch in thickness. If the panel is at least ¼ inch or more in thickness, the tuner will be adequately supported by the four front panel mounting screws. In cases where the front panel may be thin or flexible, a shelf is necessary to support the weight of the tuner. A shelf is not required when the MR65B is mounted in a metal rack panel.

An MR65B cabinet installation should provide at least 13¾ inches behind the mounting panel for clearance of leads and connectors. Allow inside dimensions of at least 16½ inches in width and 5 inches in height for adequate air circulation. The back panel of the MR65B cabinet should be left as open as possible for best ventilation. Avoid mounting the tuner directly over a power amplifier. The heat from the amplifier output tubes may affect the precision tuner calibration. Adequate ventilation will insure your tuner a long and trouble-free life.

CUTTING THE FRONT PANEL

The PANEL CUTOUT TEMPLATE supplied with your tuner is a full size layout of the front panel cutout and mounting holes. The template is positioned accurately on the cabinet front by drilling two locating holes through from the back side of the panel. All measurements for panel cutout location are made on the back side of the panel. One of the two end mounting strips supplied with the tuner (3½ inches by ½ inch) makes a convenient measuring tool for determining the exact positions of the locating holes.

Determine the exact center of the proposed panel cutout area. Scribe a vertical line at the center, from the top surface of the mounting shelf to the top of the panel as shown in "A" of Figure 8. Using one of the mounting strips as a measuring tool, scribe a horizontal line 3½ inches above the top surface of the mounting shelf as shown in "B" of Figure 8. Again using the mounting strip, mark a point on the horizontal line 3½ inches to the left of the center line. Mark a second point 3½ inches to the right of the center line. These two points should be 7 inches apart, 3½ inches above the mounting shelf and 3½ inches to each side of the vertical

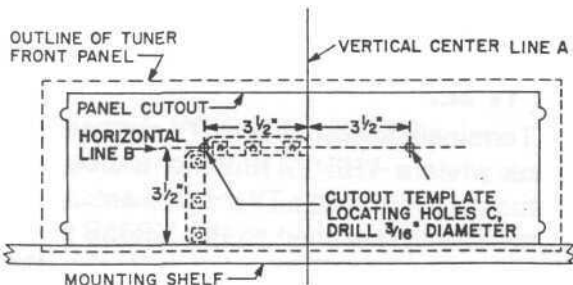

Positions "A" to "C" show the location of the vertical center line, the use of the measuring tool (mounting strip) to locate the horizontal center line, and how to measure off the two points to the right and left of the vertical center line.

Figure 8. Front Panel Cutout Measurements.

center line. See "C" of Figure 8. Drill a 3/16 inch diameter hole through the back of the panel at each of the two points. Make certain that you hold the drill perpendicular to the panel so the holes will be accurately located on the front side of the panel.

Using the previously drilled locating holes for correct alignment, carefully position the cutout template on the front panel.

Scribe the rectangular cutout on the front panel and mark the positions of the six mounting holes. Drill the six 3/16 inch diameter mounting holes before cutting the panel opening. Next cut the main panel opening. It is important that the cutout be just within the heavy black lines on the template.

SHELF MOUNTING

Locate the exact center of the proposed shelf area and scribe a line from the front to the back of the shelf. The SHELF CUTOUT TEMPLATE is marked for front panel thickness from 1/4 inch to 1 inch. Fold the template on the line that corresponds to the thickness of the particular panel being used. Place the folded template on the shelf, butted against the back side of the front panel. Match the center line on the template to the scribed center line on the shelf. The shelf center line should also exactly meet the vertical center line used to make the front panel cutout. Mark the positions of the four 1/4 inch diameter mounting holes. Scribe the rectangular cutout for the ventilating hole. Drill the four 1/4 inch diameter mounting holes and then cut out the rectangular ventilating hole.

INSTALLING THE MR65B

Remove the four 10-32 x 3/8 inch screws holding the MR65B to the shipping board. Save these screws since you will need them if your cabinet shelf is 1/2 inch or 5/8 inch thick. Remove the four plastic feet from the bottom of the tuner.

The mounting hardware package includes four 6-32 flat head screws and eight 6-32 round head screws. Two of the flat head screws of the proper length are used to attach the mounting strips to the cabinet panel. Four of the round head screws of the proper length are used to attach the tuner to the mounting strips and the cabinet panel. The 6-32 x 1/2 inch screws are used with

panels under 3/8 inch thickness. The 6-32 x 1 1/4 inch screws are used with panels from 3/8 inch to 1 inch thickness.

The edge of the strip with the clips must face toward the panel opening. Line up the mounting strips on each side of the panel cut-out so the three holes in the strips are in line with the holes in the panel. Install two of the proper length flat head screws through the front panel and into the center hole of each mounting strip. Drive the screws in so the flat heads are flush with the panel. If necessary, countersink the two center holes.

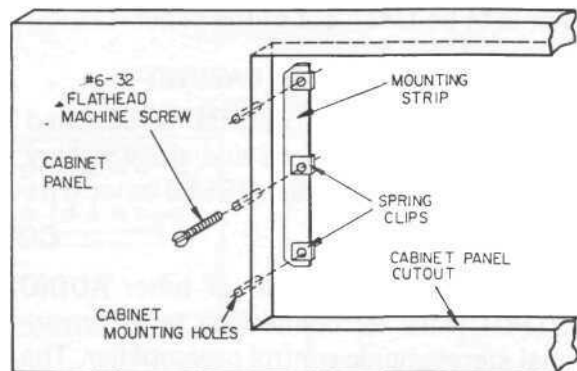

Figure 9. Securing the Mounting Strip to Front Panel.

Carefully insert the tuner through the front panel opening so it rests on the supporting shelf. Insert the proper length round head screws into the four holes in the mounting flanges on each end of the tuner panel. Drive the screws in through the panel and into the threaded clips on the mounting strips. Do not tighten these screws yet.

If the cabinet is fixed and will not be moved about, it is not necessary to secure the tuner chassis to the shelf. If the cabinet is to be moved about, it is recommended that the tuner chassis be secured to the shelf in the following manner.

Tighten the four screws holding the tuner to the front panel. The four 10-32 x 3/8 inch screws used in shipping the tuner are also used to mount it to a shelf of 1/2 inch or 5/8 inch thickness. Use the 10-32 x 1/2 inch screws if the mounting shelf is 3/8 inch thickness or less. Use the 10-32 x 1 inch screws if the shelf is 3/4 inch or 7/8 inch thickness. Secure the chassis with the proper length

10-32 screws by inserting them up through the holes in the shelf, and into the threaded holes in the tuner chassis bottom. Tighten the 10-32 screws after you have first tightened the front panel screws.

IMPORTANT

Use of the wrong length 10-32 screws may cause electrical shorting in the tuner circuits.

Attach the two metal panel end caps (packed with the tuner) on each end of the tuner panel by sliding onto the pins. (See Figure 10.) The end caps are held by spring tension and can easily be removed if the tuner is to be taken out of the cabinet.

MOUNTING IN THE L66 CABINET

The McIntosh L66 cabinet is supplied with complete instructions and all necessary hardware for installing the MR65B tuner. The

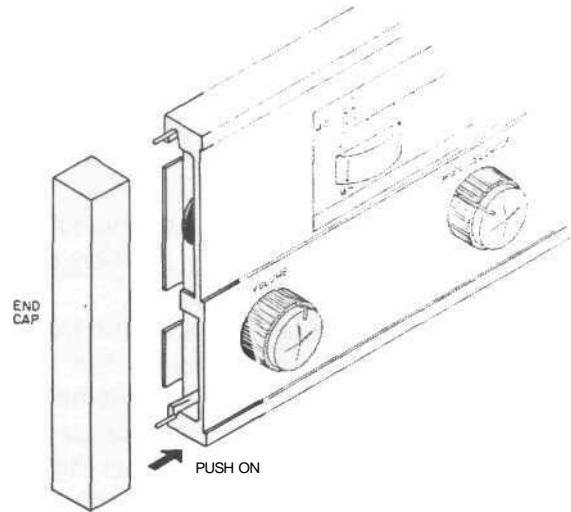

Figure 10. Fitting of Panel End Caps to Panel.

dimensions of the L66 cabinet are 16⁹/₁₆ inches wide by 6-11¹⁶/₁₆ inches high including mounting feet by 13³/₄ inches deep including tuner front panel and control knobs.

CONNECTING

Use the left hand pair of tuner AUDIO OUTPUT jacks for connecting to a conventional stereophonic control preamplifier. The output volume levels at these jacks are affected only by the tuner back panel dual concentric OUTPUT ADJ controls. The left hand pair of jacks is recommended when the tuner is used with a McIntosh control preamplifier.

Use the right hand pair of AUDIO OUTPUT jacks when you wish to use the tuner front panel volume control. Use these jacks for connecting directly to tape recorders, power amplifiers or any equipment without its own volume control.

There is no difference in the signal quality or available output level at each pair of output jacks.

STEREOPHONIC FM MULTIPLEX

Connect a shielded cable from the proper tuner LEFT channel AUDIO OUTPUT jack, to the control preamplifier LEFT channel tuner or auxiliary input jack.

Connect a second shielded cable from the proper RIGHT channel tuner AUDIO OUTPUT jack to the corresponding control preamplifier RIGHT channel tuner or auxiliary input jack.

Suitable shielded cables are supplied with the tuner.

MONOPHONIC FM

Connect a shielded cable from the proper

tuner left or right audio output jack to the monophonic control preamplifier tuner or auxiliary input jack. With the tuner MODE SELECTOR set to FM, the monophonic FM signal appears at BOTH the left and right channel AUDIO OUTPUT jacks.

REMOTE AMPLIFIERS

The two AUDIO OUTPUT jacks not being used in an installation may be connected to external or remote amplifiers. FM programs can then be fed to speaker locations apart from the main sound system.

OFF-THE-AIR RECORDING

Tape recorders or tape decks with record-playback preamplifiers are normally connected to the Tape Output jacks on the control preamplifier. Any FM program coming from the tuner into the preamplifier can then be recorded on tape. You may also connect the extra pair of tuner audio output jacks directly to the recorder inputs if desired.

ANTENNA CONNECTIONS

Satisfactory FM multiplex stereo reception requires approximately 10 times as much signal from the antenna compared to equivalent FM monophonic reception. Monophonic installations that were satisfactory with an indoor FM antenna may require an outside or directional FM antenna for equivalent FM multiplex reception.

INDOOR FLEXIBLE FM DIPOLE

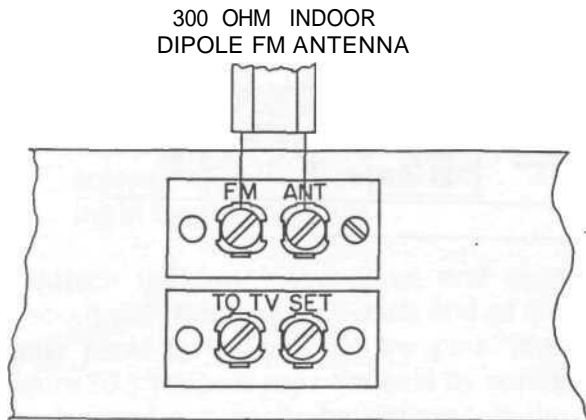

Figure 12. Connection of 300 Ohm Indoor Dipole FM Antenna to MR65B.

A convenient flexible indoor dipole (300 ohm) antenna is supplied with the MR65B tuner. This antenna is easy to install and is suitable for good FM reception in urban or high intensity signal areas.

Connect the two leads of the dipole antenna to the two terminals marked FM ANT on the tuner back panel. The flexibility of the thin flat wire allows the dipole to be easily located behind the equipment enclosure or in any convenient position near the tuner. Open the dipole into "T" and extend the arms as straight as possible. The dipole antenna is somewhat directional and may have to be positioned in a particular location for best reception of desired stations.

IMPORTANT

Keep the dipole away from large metal objects or surfaces since they may interfere with the efficiency of the antenna.

OUTDOOR FM ANTENNA

An outdoor FM antenna is always recommended for best FM reception under all conditions. In fringe or outlying areas especially, a highly directional FM antenna used in conjunction with a rotator will give the finest possible FM reception. Rotate the antenna until it points in the direction of the station or until it receives the best possible signal.

The FM signal strength meter aids in positioning a directional antenna. Observe the meter indication for a given station as the

antenna rotates. The meter will indicate its highest reading when the antenna is pointed in the direction for maximum signal pickup.

75 OHM ANTENNA

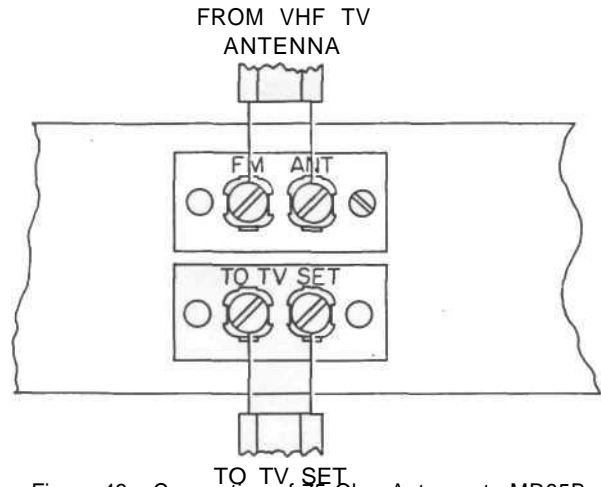

Figure 13. Connection of 75 Ohm Antenna to MR65B.

An unbalanced 75 ohm FM antenna may also be used with the MR65B. Connect the center lead of the coaxial lead-in cable to the right hand FM ANT terminal. Connect the shield of the coaxial cable to the ground screw next to this same FM ANT terminal.

VHF TV ANTENNA

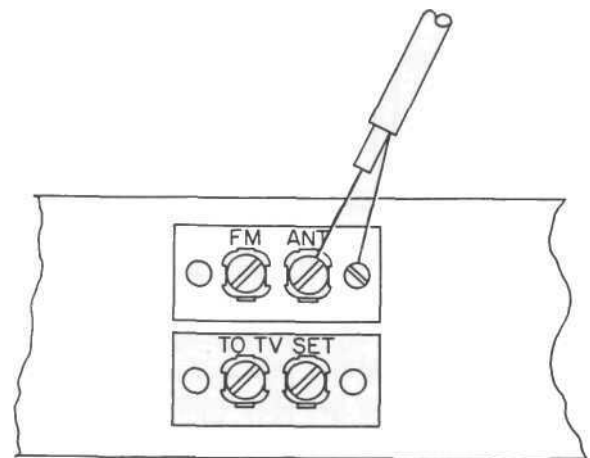

Figure 14. VHF TV Antenna Connections.

A conventional VHF TV antenna of the type also suitable for FM may be used with the MR65B. Connect the two leads from the 300 ohm TV antenna lead-in wire to the two FM ANT terminals on the tuner back panel. Connect a length of 300 ohm flat lead-in wire from the TO TV SET terminals on the tuner back panel to the antenna terminals of the TV set.

OPERATING INSTRUCTIONS

STEREOPHONIC FM MULTIPLEX

1. Turn the MODE SELECTOR to MPX STEREO.
2. Turn the AUTO FREQ control to MAX.

Automatic Frequency control corrects the electrical station tuning to the exact point for minimum distortion. An electronic delay turns on the Automatic Frequency control over a 3 second interval after the dial pointer stops on a station. For all normal tuning, set the AUTO FREQ CONTROL to MAX.

If stations are close together on the dial or if a desired station is close to a much stronger station, reduce the AUTO FREQ CONTROL setting for best tuning.

3. Turn MUTING to IN.

McIntosh Ultrasonic muting suppresses all background noise and hiss usually heard when tuning between stations. Use MUTING IN for all normal tuning.

Weak or distant stations that don't override the background noise and interference are also suppressed. Turn MUTING OUT to listen to these weaker stations.

4. Turn the FM TUNING dial to the desired station. The tuning meter should indicate in the center black area. If the red MPX indicator lights, the station is broadcasting multiplex stereo. The MPX indicator lights ONLY when the tuner is receiving a station broadcasting FM multiplex stereo. The indicator will NOT light on noise or interference signals.

If the same station broadcasts a regular monophonic FM program, the MPX indicator will remain off.

5. Adjust the appropriate volume controls, depending on which pair of AUDIO OUTPUT jacks is being used.

The front panel VOLUME control operates only with the pair of AUDIO OUTPUT jacks marked FRONT PANEL CONTROLLED. Set the VOLUME control to its mid position.

The OUTPUT ADJ controls on the back panel pre-set the volume levels of the left hand pair of AUDIO OUTPUT jacks. Turn the outer knurled sleeve for RIGHT channel volume and the center knurled shaft for LEFT channel volume. Set the OUTPUT ADJ controls to their mid positions. Make final volume adjustments to balance the tuner volume

with the volume of a phono record playing through the control preamplifier.

MONOPHONIC FM

1. Turn the MODE SELECTOR to FM.
2. Turn the AUTO FREQ CONTROL to MAX. (Adjust the same as for MPX reception.)
3. Turn MUTING to IN. (Set the same as for MPX reception.)
4. Turn the FM TUNING dial to the desired station. The tuning meter should indicate in the center black area.
5. Adjust the appropriate volume controls, depending on which pair of AUDIO OUTPUT jacks is being used. (Adjust the same as for MPX reception.)

EXTERNAL STEREO

1. Connect an external tuner to the back panel EXT STEREO INPUT jack.
2. Turn the MODE SELECTOR to EXT STEREO.
3. Turn the AUTO FREQ CONTROL to MAX. (Adjust the same as for MPX reception.)
4. Turn the FM TUNING dial to the FM station broadcasting one channel of a stereophonic broadcast. The tuning meter should indicate in center black area. (The FM broadcast appears in the RIGHT channel.)
5. Tune the external tuner to the station broadcasting the other channel of the stereophonic broadcast. (The external tuner program appears in the LEFT channel.) The EXT STEREO function will most often be used for AM-FM stereophonic broadcasts. The station broadcasts one channel of a stereo program on the AM transmitter and the other channel on the FM transmitter.
6. Adjust the appropriate volume controls, depending on which pair of AUDIO OUTPUT jacks is being used. (Adjust the same as for MPX reception.) If the external tuner has a volume control, adjust it to equal the volume level of the MR65B.

ADJUSTMENTS

MUTING THRESHOLD

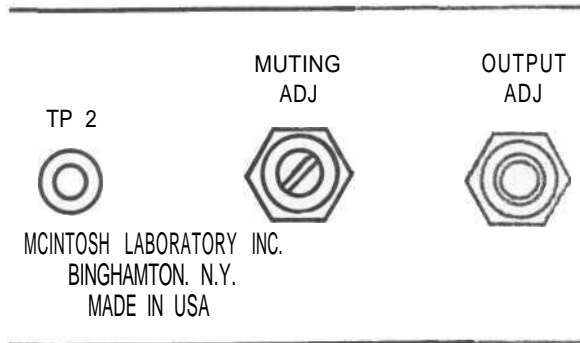

Figure 15. Muting Threshold

The MR65B ultrasonic muting circuit suppresses all noise between stations. It also suppresses all weaker stations not strong enough to over-ride the background noise.

The muting threshold setting determines the strength of the signal which can be heard with muting in operation. The muting threshold is carefully adjusted to optimum at the factory using precision test instruments. Casual adjustment of the muting threshold is not recommended.

If it is found necessary to adjust the muting threshold, use the MUTING ADJ control on the tuner back panel. Turn the MUTING ADJ control to the RIGHT (clockwise) to lower the muting threshold. This allows weaker, noisier stations to be heard at the MUTING IN setting. Turn the MUTING ADJ control to the LEFT (counterclockwise) to raise the muting threshold. This allows only the more powerful stations to be heard at the MUTING IN setting.

FM SIGNAL STRENGTH METER

The FMSIGNALSTRENGTH meter pointer should normally rest on the zero scale marking with FM operating but no station tuned in.

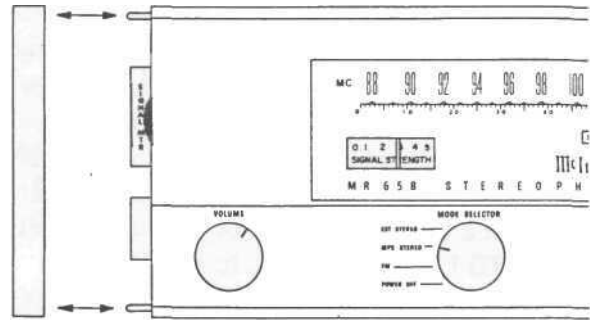

Figure 16. FM Signal Strength Meter

To adjust, turn the MODE SELECTOR to FM. Turn the MUTING control OUT. Turn the AUTO FREQ control to MIN. The volume control has no effect on this adjustment. Turn the tuning dial to a position NOT on or near a station. Allow the tuner to operate for approximately 5 minutes. Rotate the red SIG STH thumb wheel control (under the left dial panel end cap) until the meter pointer is centered on the zero scale marking.

FM TUNING METER

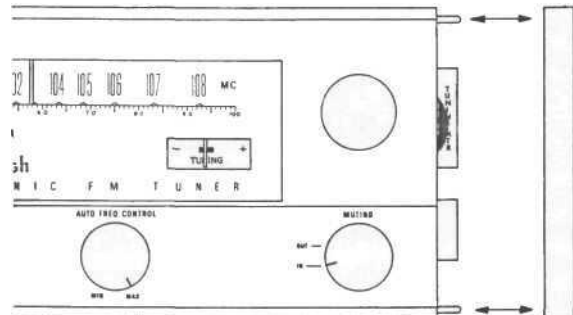

Figure 17 . FM Tuning Meter.

The FM TUNING meter pointer should normally rest within the center black area of the scale when an FM station is properly tuned.

Check the tuning meter adjustment in the following manner after the tuner has been operating approximately 5 minutes.

Turn the MODE SELECTOR to FM. Turn the AUTO FREQ CONTROL to MIN (counterclockwise). The MUTING and VOLUME controls have no effect on this adjustment and

may be set in any position. Tune to an FM station until the meter pointer is exactly in the center of the black scale area. Turn the AUTO FREQ CONTROL to MAX (clockwise). Wait a few seconds and watch the meter pointer to see if it moves off the center of the black scale area.

If the meter pointer changes position, adjust the red TUNING MTR thumb wheel control (under the right dial panel end cap) until the meter pointer moves back to the center of the black area. Check the adjustment by repeating the procedure. Again turn the AUTO FREQ CONTROL back to MIN and re-tune the station. Turn the AUTO FREQ CONTROL up to MAX and again check for meter pointer movement. Adjust the tuning meter thumb wheel control again if necessary to re-center the meter pointer in the black area. If the meter pointer moves an appreciable amount on the first test, the second adjustment is necessary for precise meter operation. When the meter circuit is properly adjusted the meter pointer should stay centered in the black scale area when the AUTO FREQ CONTROL is turned from MIN to MAX.

When the FM tuning meter is adjusted by this procedure, precise FM tuning is insured with the meter pointer centered in the black scale area. This procedure eliminates the possibility of noise affecting the meter adjustment.

DIAL PANEL LIGHTS

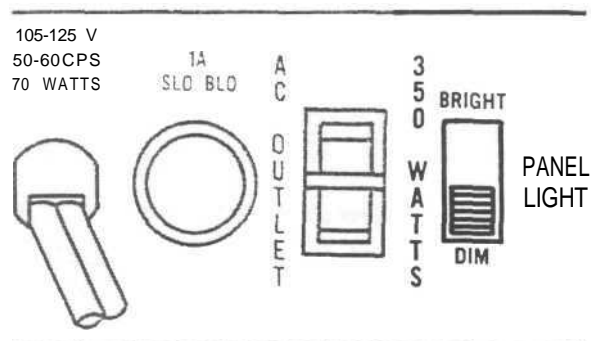

Figure 18. Dial Panel Lights.

Adjust the brightness of the dial panel lights by means of the PANEL LIGHT switch on the tuner back panel. Set the switch to BRIGHT for maximum panel light. Set the switch to DIM for less dial light and extended lamp life.

OUTPUT ADJUST

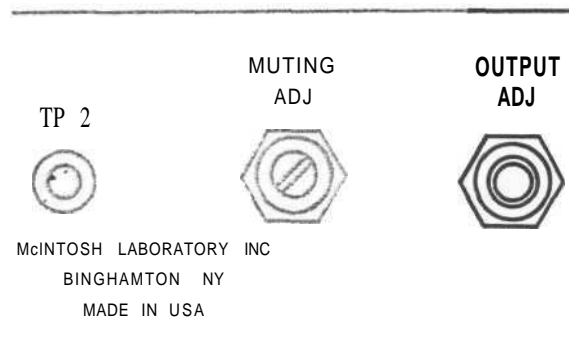

Figure 19. Output Adjust

The dual concentric OUTPUT ADJ controls (on the tuner back panel) adjust the output volume level of the left hand pair of AUDIO OUTPUT jacks. The center shaft of the control adjusts the left channel output. The outer sleeve of the control adjusts the right channel output.

To adjust, first connect the left hand AUDIO OUTPUT jacks to the tuner inputs of the control preamplifier being used. Set the preamplifier selector to phono and the volume control to normal listening level for a typical stereo disc recording. Switch the preamplifier back to the tuner. Set the MR65B MODE SELECTOR to FM and tune in a local station. Turn the tuner OUTPUT ADJ controls until the levels of each channel are equal to each other and also equal to the volume level of the previous phono recording. You can now switch the preamplifier selector from the MR65B to other program sources without need for readjusting the main volume control.

Your McIntosh MR65B tuner will give you many years of pleasant and satisfactory performance. If you have any questions concerning the operation or maintenance of this tuner, please contact

CUSTOMER SERVICE
MCINTOSH LABORATORY INC.
2 CHAMBERS STREET
BINGHAMTON, NEW YORK

Our telephone number is 723-5491.
The direct dial area code is 607.

GUARANTEE

McIntosh Laboratory, Inc. guarantees this equipment to perform as advertised. We also guarantee the mechanical and electrical workmanship and components of this equipment to be free of defects for a period of 90 days from date of purchase. This guarantee does not extend to components damaged by improper use nor does it extend to damage incurred during transportation to and from McIntosh Laboratory, Inc.

3-YEAR FACTORY SERVICE CONTRACT

An application for a FREE 3-YEAR FACTORY SERVICE CONTRACT is included in the pocket in the back cover of this manual. The FREE 3-YEAR FACTORY SERVICE CONTRACT will be issued by McIntosh Laboratory upon receipt of the completely filled out application form. The term of this contract is defined in the 3-Year Factory Service Contract. If the application is not mailed to McIntosh Laboratory, only the services offered under the standard 90-day guarantee will apply on this equipment. TAKE ADVANTAGE OF 3 YEARS OF FREE FACTORY SERVICE BY FILLING IN THE APPLICATION NOW.

In Canada: Manufactured under license by:
McCurdy Radio Industries, Ltd.
22 Front Street West
Toronto, Canada

McIntosh LABORATORY INC.

2 CHAMBERS STREET, BINGHAMTON, N. Y.

Made in U.S.A.

Phone-Area Code 607-723-5491