



IC-150

SM-2

S1-P2-33-0

CROWN

SERIAL NO. _____

ISSUED TO _____

**SERVICE MANUAL
IC-150
INTEGRATED CIRCUIT
STEREO CONSOLE**



Handwritten text, possibly a signature or date, located in the upper right quadrant.

Two lines of handwritten text in the middle section of the page.

Three lines of handwritten text in the lower middle section of the page.

TABLE OF CONTENTS

SECTION	DESCRIPTION	PAGE
1	INTRODUCTION	
1.1	Scope of Manual	1
1.2	Equipment Description	1
1.3	Hi-Fi Terms — Glossary	2
2	SPECIFICATIONS	3
3	INSTALLATION AND OPERATION	
3.1	General	5
3.2	Unpacking	5
3.3	Mounting	5
3.4	AC Power	5
	3.4.1 System Interconnections — IC-150 Stereo Console and Power Amplifiers	6
3.5	Input Connections	6
3.6	Output Connections	7
3.7	Detailed Function of Front Panel Controls	7
3.8	Using the Selector Switch and Tape Recorders	7
3.9	Combined Function of PANORAMA and BALANCE Controls	16
3.10	Using the External Muter	16
4	CIRCUIT DESCRIPTION	
4.1	General	17
4.2	Principles of Operation	17
4.3	Input Circuitry	19
	4.3.1 High Level Inputs	19
	4.3.2 Phono Inputs	19
4.4	Output Circuitry	19
	4.4.1 Main Outputs	19
	4.4.2 Tape Outputs	19
4.5	Frequency Response	20
4.6	Volume Control and Loudness Control	21
4.7	Tone Controls and Filters	22
4.8	Phase Response	24
4.9	Distortion	25
4.10	Hum and Noise	26
4.11	Square Wave Response	28
4.12	Crosstalk	28
4.13	Separation	28

TABLE OF CONTENTS (Continued)

5	SERVICE PROCEDURES	
5.1	Introduction	29
5.2	Service Policies	29
5.3	Warranty	29
5.4	Disassembly for Servicing	29
5.4.1	Removal of Top and Bottom Covers	29
5.4.2	Replacement of Selector Switch (SW1)	29
5.4.3	Replacement of Main PC Board Assembly	29
5.4.4	Replacement of Phono PC Board Assembly	30
5.4.5	Replacement of Volume Control (R24)	30
5.4.6	Replacement of Balance Control (R25)	30
5.4.7	Replacement of Bass Control (R39)	30
5.4.8	Replacement of Treble Control (R33)	31
5.4.9	Replacement of Panorama Control (R32)	31
5.4.10	Replacement of Push-For-Loudness Switch (SW4) and Push-For-Flat Switch (SW6, Tone Cancel)	31
5.4.11	Replacement of Pushbutton Switch Assembly, 40817 (SW2, Tape 1, SW3, Tape 2; SW5, Lo Filter; SW7, Hi Filter; AC ON)	31
5.4.12	Replacement of Power Switch (SW8)	31
5.4.13	Replacement of Power Transformer (T1)	31
5.5	Test Equipment	32
5.5.1	Calibration of Test Equipment	32
5.6	Test Procedures	33
5.7	Troubleshooting	33
5.7.1	Turn-on Procedure	34
5.7.2	Power Supply Test, +18VDC and -18VDC	34
5.7.3	Tracking Test	34
5.7.4	Panorama Test	38
5.7.5	Balance Test	38
5.7.6	Loudness Test	38
5.7.7	Low Filter Test	38
5.7.8	Bass Adjust Test	39
5.7.9	Response and Stability Test	39
5.7.10	Slew Test	39
5.7.11	Treble Adjust Test	39
5.7.12	High Filter Test	39
5.7.13	Treble Range Test	40
5.7.14	Bass Range Test	40
5.7.15	Phono Gain Test	40
5.7.16	Phono Response Test	40
5.7.17	Intermodulation (IM) Distortion Test	40
5.7.18	High Level Noise Test	40
5.7.19	Phono Noise Test	42
5.7.20	Controls Test	42
5.7.21	Muter Turn-on Test	42
5.7.22	Miscellaneous Problems	42
6	SCHEMATICS, PARTS LISTS AND COMPONENT LOCATION	
6.1	General Information	45
6.2	Parts Replacement	45
6.3	Schematics and PC Boards	45
7	APPLICATION NOTES	63
1.	Replacement of H. H. Hilton Tantalum Capacitors in 1 MFD, 4 MFD and 6.8 MFD Values	64
2.	Replacement Kit (CPN 41236) for IC-150 Volume Control (R24)	65
3.	Input Level Controls for System Power Amplifiers	66
4.	IC-150 Update — Parts List, Board Layout	67
5.	IC-150 Update — Schematic MI-243D	69

LIST OF ILLUSTRATIONS

FIGURE	TITLE	PAGE
1-1	IC-150 Integrated Circuit Stereo Console	1
3-1	Mounting Dimension Diagram	5
3-2	220-Volt Wiring Conversion Diagram	6
3-3	Input Equipment Connection Diagram	9
3-4	Output Equipment Connection Diagram	11
3-5	IC-150 Front Panel Controls	13
3-6	Selector Switch — Tape Recorders	14
3-7	PANORAMA/BALANCE Controls	15
3-8	External Muter Wiring	16
4-1	IC-150 Stereo Console, Signal Flow Diagram	18
4-2	IC-150 Comparative Signal Levels	19
4-3	Typical Frequency Response	20
4-4	Typical Maximum Output: Phono Preamp	21
4-5	Typical Loudness Contours	22
4-6	Normalized Loudness Correction Curves	22
4-7	Typical Tone Control and Filter Curves	23
4-8	Typical Phase Response	24
4-9	Typical IM Distortion	25
4-10	Comparison of Noise and Program Levels	26
4-11	Control Settings for Minimum Noise	27
4-12	Square Wave Response	27
5-1	IC-150 Inspection Report	35
5-2	Typical Tracking Test Readings	37
5-3	Typical Loudness Test Output	38
5-4	Typical Low Filter Output	38
5-5	Typical 10 KHz Square Wave Output	39
5-6	Typical High Filter Square Wave Output	39
5-7	Test Equipment Setup	41
6-1	Schematic Diagram, IC-150 Stereo Console, (SN IC-2354 and later)	47
6-2	Schematic Diagram, IC-150 Stereo Console, (SN IC-762 thru IC-2353)	48
6-3	Schematic Diagram, IC-150 Stereo Console, (SN IC-402 thru IC-761)	49
6-4	Schematic Diagram, IC-150 Stereo Console, (SN IC-100 thru IC-401)	50
6-5	Component Location, Main PC Board, 7867	51
6-6	Component Location, Main PC Board, 7888	52
6-7	Component Location, Main PC Board, 7923	53
6-8	Component Location, Volume Control Board, 7868	54
6-9	Component Location, Phono PC Board, 7829	55
6-10	Component Location, Phono PC Board, 7999	56
6-11	Exploded View Diagram, Chassis Assembly, 40821	57
6-12	Exploded View Diagram, Bottom Cover Assembly, 40829	58
6-13	Exploded View Diagram, Front Panel Assembly, and Labels	59
6-14	Exploded View Diagram, Input Selector Switch Assembly, 40825	60
6-15	Exploded View Diagram, Pushbutton Switch Assembly, 40817	61
6-16	Exploded View Diagram, Jack Panel Assembly, 41256	62

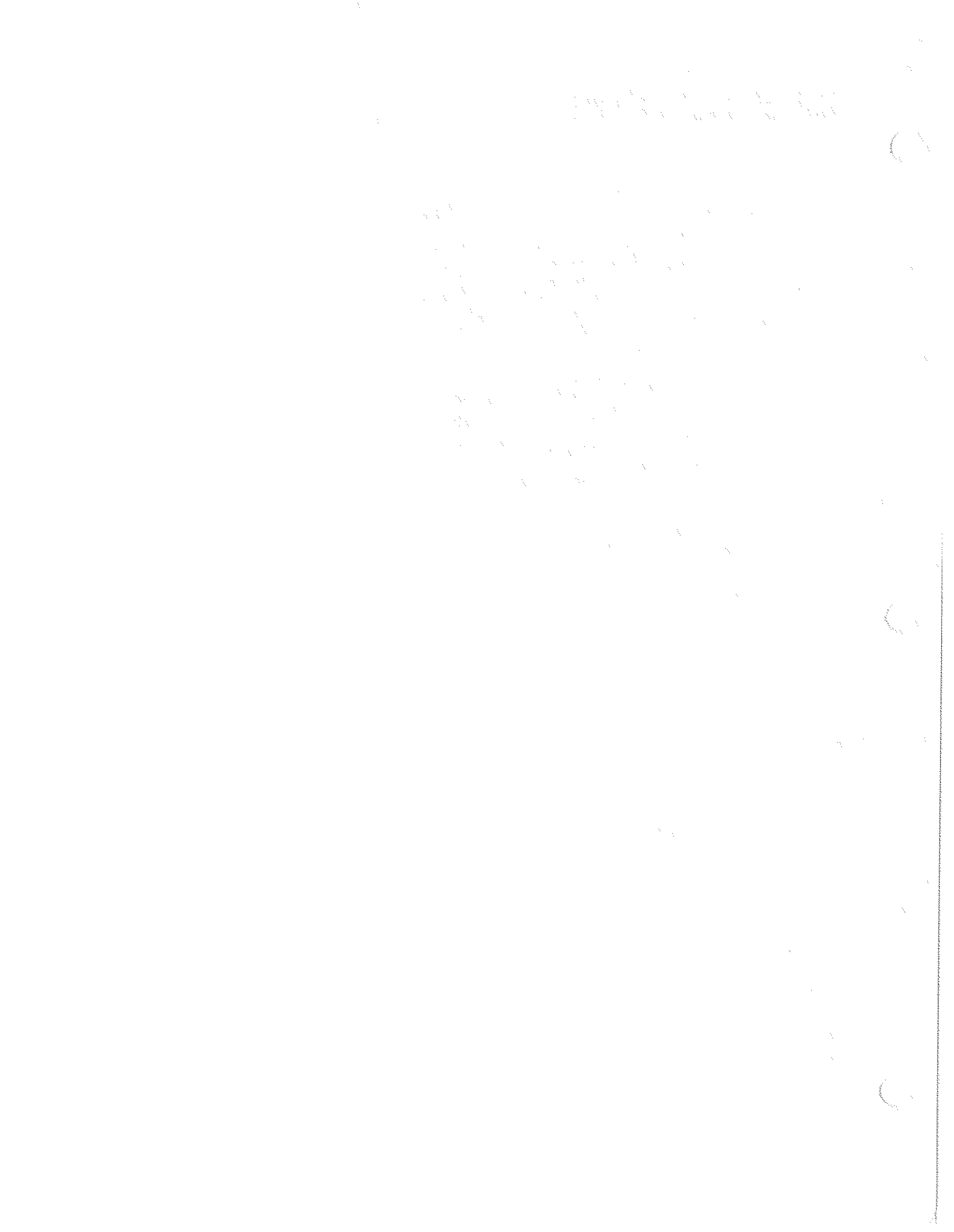



FIGURE 1-1. IC-150 INTEGRATED CIRCUIT STEREO CONSOLE

1.1 SCOPE OF MANUAL

This manual is intended to provide the user and service technician necessary technical information required to install, operate and repair the CROWN IC-150 Integrated Circuit Stereo Console properly and to maintain the unit in optimum operating condition.

The manual is comprehensive, containing a physical description of the IC-150, electrical and mechanical specifications, complete installation and operating instructions, a detailed circuit description and service procedures to include troubleshooting and repair. Also included are complete parts lists, a unit schematic and exploded view drawings to assist in identification of parts and understanding the functional operation of the IC-150 stereo console.

A thorough reading of this manual and strict adherence to the instructions, procedures and cautions will assure many years of professional quality service and listening enjoyment from your CROWN IC-150 Integrated Circuit Stereo Console.

1.2 EQUIPMENT DESCRIPTION

The CROWN IC-150 Integrated Circuit Stereo Console is specifically designed to provide precise reproduction of all types of music and the versatile controls allow almost unlimited selection to suit your particular requirements.

Up to seven program sources may be connected as inputs to the IC-150 on the rear panel; two tape recorders with 2 or 3-head configurations, a tuner, two phono turntables, and two auxiliary sources (microphones, guitar amplifiers, cassette recorders, tuners, tape recorders, etc.). All program sources are available through the front panel SELECTOR switch.

Four output connections are available on the IC-150 rear panel; a power amplifier, headphone amplifier and two tape recorders.

It should be obvious from the variety of inputs and outputs available that a great number of system configurations may be designed by the experienced hi-fi buff. The IC-150 will handle them all efficiently. Several typical combinations are described in Section 3, Installation and Operation.

Four switched ac outlets are available on the rear panel of the IC-150 to power other system components. The ON-AC pushbutton on the IC-150 front panel applies ac power to the IC-150 and any components connected to the switched outlets. One unswitched outlet is also located on the rear panel; this outlet is not affected by the ON-AC pushbutton switch.

There are four basic ways to display your IC-150; custom mounted, standard 19" rack mounted, mounted in the accessory 5-R walnut cabinet, or free standing in its attractive vinyl case. Detailed instructions for the various mounting configurations are found in Section 3, Installation and Operation.

1.3 HI-FI TERMS — GLOSSARY

- A-B Test . . .** Evaluating relative performance of two (or more) components or systems by changing quickly from one to the other. Most high fidelity dealers have A-B test facilities.
- Acoustic or Mechanical Feed-back . . .** An annoying low frequency interference created when vibrations from loudspeakers are picked up by the cartridge and amplified by the sound system. Physically separating loudspeakers and record-playing equipment will solve the problem.
- Channel . . .** A channel is a complete sound path. A single channel, or monophonic system, has one channel. A stereophonic system has at least two full channels designated as left (A) and right (B). Monophonic material may be played through a stereo system; both channels will carry the same signal. Stereo material, if played on a monophonic system, mixes and emerges as a monophonic sound.
- Crossover . . .** A frequency at which other frequencies above and below it are separated. In a two-way speaker system, for instance, the crossover frequency is the point at which woofer and tweeter response are divided.
- Crosstalk . . .** Signal leakage between two channels.
- Damping . . .** Controlling of vibrations, response, or resonances which if unchecked would cause distortion.
- Decibel . . .** A numerical expression of acoustic or electrical ratios, such as the relative intensity of a sound or the relative strength of a signal. One to three decibels (db) is about the smallest change in sound perceptible to the ear.
- Distortion . . .** Unwanted noise, or sounds which didn't exist in the studio when the original recording was made. Harmonic distortion disturbs the original relationship between a tone and other tones naturally related to it. Intermodulation distortion (IM) introduces new tones caused by mixing of two or more original tones. Phase distortion, or non-linear phase shift, disturbs the natural timing sequence between a tone and its related overtones. Transient distortion disturbs the precise attack and decay of a musical sound. Harmonic and IM distortion are expressed in percentages; phase distortion in degrees; transient distortion is usually judged from oscilloscope patterns, but is best measured as phase distortion.
- Equalization . . .** Frequency manipulation to meet the requirements of recording, and an inverse manipulation on playback to get uniform response. Also known as compensation.
- Flutter . . .** Rapid variations in the speed of a turntable or tape transport. When pronounced, flutter causes a wavering of musical pitch.
- Hertz . . .** As in cycles-per-second, not rental agency.
- IHF Music Power . . .** This rating expresses the ability of an amplifier to handle short duration power peaks, as opposed to sustained power levels. An amplifier may only be capable of putting out 45 watts if that level is continuous, but it may be able to handle 60 watt peaks (such as might occur in a musical passage), if the peaks do not last too long.
- IHF Noise Measurement . . .** Any of 3 defined ways to measure noise, each of which uses a different filter, or frequency-weighting method, in making the test; usually the IHF "A" weighting is the reference, since this measurement simulates the Fletcher-Munson loudness curves, and is therefore insensitive to high and low frequency noise. This method produces the largest signal-to-noise specification.
- Phon . . .** A unit of loudness for steady tones, correlated with the Fletcher-Munson loudness curves, and referenced to the db level at 1KHz. 100 phons equals 100db at 1KHz, while 100 phons at 100 cycles is about 103db (cf Fletcher-Munson curves shown in discussion of loudness control).
- Signal-to-Noise Ratio . . .** Often abbreviated as S/N ratio; the proportion of signal to undesired and extraneous noises in any device or its output. The higher the ratio, the better. Expressed in decibels.

SECTION 2
SPECIFICATIONS

FREQUENCY RESPONSE	Hi-level: ± 0.6 dB 3Hz-100KHz with hi-impedance load, ± 0.1 dB 10Hz-20KHz with IHF load; Phono: ± 0.5 dB of RIAA, calibrated
PHASE RESPONSE	Hi-level: typically $+1^{\circ}$ to -12° 20Hz-20KHz with IHF load; Phono: typically $\pm 5^{\circ}$ 20Hz-20KHz additional phase shift
HUM AND NOISE	20Hz-20KHz inputs shorted; Hi-level; 90dB below rated output (typically 100dB with IHF "A" weighted measurement; Phono: 80dB below 10mV input) typically 0.5uV input noise
DISTORTION THD	essentially unmeasurable; IM: less than 0.01% at rated output with IHF measurement (typically under 0.002%)
INPUTS	five hi-level inputs (1 tuner, 2 auxiliary, 2 tape) two equalized phonos
INPUT GAIN & IMPEDANCE	Hi-level: 20.8dB ± 0.2 dB, 100K ohms; Phono: 50-70dB (adjustable) 47K ohms. Sensitivity: 1mV @ 1KHz for rated output.
PHONO INPUT OVERLOAD	33-330mV at 1KHz, depending on gain (100mV when set to 60dB total preamp gain)
OUTPUT	10v maximum before overload, 2.5 rated, 600 ohms output impedance
PHONO OUTPUT & IMPEDANCE	(at tape out) 600 ohms with typical maximum output of 9v RMS at 1KHz into hi-impedance load
VOLUME CONTROL	over 60dB dynamic range with calibrated tracking
LOUDNESS COMPENSATION	new wide-range design for excellent simulation of Fletcher-Munson curves down to 60 phons; with exclusive dual R/C bass-boost coordinated with volume control
PANORAMA CONTROL	unique, continuously-variable control for infinite adjustment from stereo to mono to stereo-reverse, replaces confusing conventional stereo-mode switches and blend controls with the first intuitive control of stereo spatial dimension
TONE CONTROLS	continuously variable ± 15 dB at 30Hz and 15KHz. cancel switch bypasses independent bass and treble control settings to give instant true-flat response in both channels
MUTING	uses plug-in reed relay — removes turn-on transients from IC-150 output thus protecting speakers
FILTERS	Rumble: -3dB at 50Hz with 6dB-per-octave cut-off; Scratch: -3dB at 5KHz with 12dB-per-octave cut-off.
AC OUTLETS	four switched with 25A switch, one unswitched
POWER REQUIREMENTS	about 2 watts at 120v or 240v 50-400Hz AC
SEMICONDUCTOR COMPLEMENT	two integrated circuits (equivalent to 42 bipolar transistors and 2 FET) for a total of 54 bipolar transistors, three FET, three zeners and seven diodes
DIMENSIONS	5 $\frac{1}{4}$ " H x 17" W; 8 $\frac{1}{2}$ " behind panel
WEIGHT	10 lbs., with walnut cabinet 16 lbs.

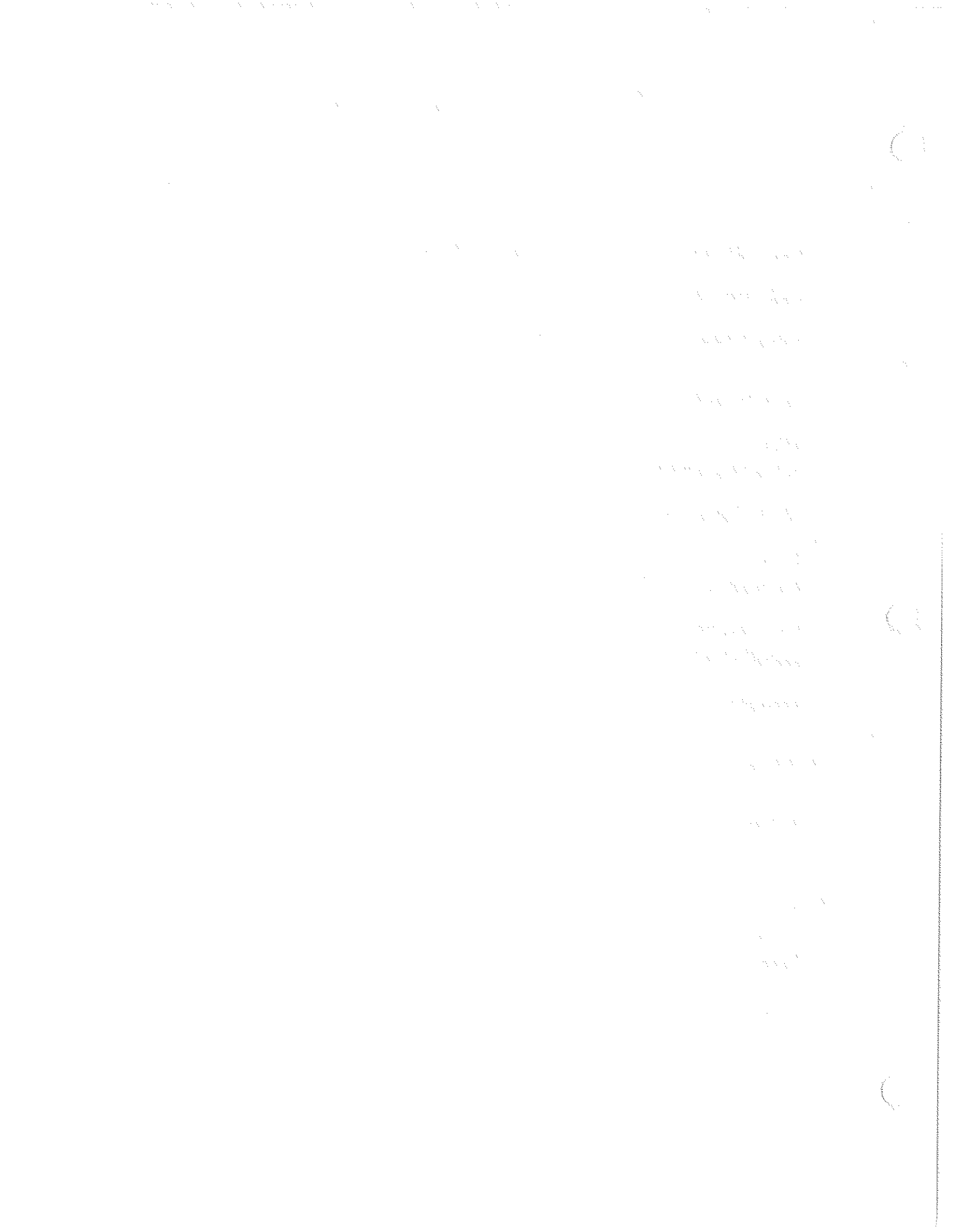

INSTALLATION AND OPERATION

3.1 GENERAL

This section contains installation and operation instructions for the IC-150 stereo console. Also included are input and output interconnection diagrams and a detailed explanation of the use of all controls and indicators.

3.2 UNPACKING

Immediately upon receipt of the IC-150 shipment, inspect the unit for any damage incurred in transit. The unit was carefully inspected and tested and left the factory unmarred. Notify the transportation company immediately if any damage is found. Only the consignee may initiate a claim with the carrier for damage during shipment. However, CROWN will cooperate fully in such an event. Be sure to save the carton as evidence of damage for the shipper's inspection.

CROWN recommends that you save the packing materials, even if the unit arrives in perfect condition. They will prove valuable in preventing damage should there be occasion to transport or ship the unit. Both the carton and internal pack are specifically designed for protection during transit. **Do not ship the unit without this factory pack!**

Be sure to return the warranty registration form to the CROWN factory within ten days for the full warranty coverage.

3.3 MOUNTING

Refer to Figure 3-1 for the IC-150 mounting dimensions. Detailed mounting instructions follow:

Custom Mounting — a full-size template of the IC-150 is enclosed in the rear of the manual received with the unit. This template also includes dimensions for the shelf which is recommended.

Accessory Cabinet — To install the IC-150 in the Model 5-D or 5-R walnut cabinet for shelf or table mounting:

1. Remove four rubber feet from unit bottom cover. Retain screws.
2. a. 5-D — Slide the IC-150 carefully into the front opening of the 5-D and secure with four screws supplied with the cabinet.
- b. 5-R — Install the rack mount ears in place of the end bars as per steps 1 and 2 under rack mounting. Carefully slide the IC-150 into the front opening of the 5-R and secure with four screws supplied with the cabinet.

CAUTION!

Do not overtighten these screws.

3. a. Attach four new feet, supplied with the 5-D, using the screws removed in Step 1.
- b. Omit this step with the 5-R cabinet.

Rack Mounting — The following parts are required:

- 2 Angle brackets, CPN 3341
- 4 Nylon washers, CPN 2119
- 1 Allen tool, 7/64, CPN 3454
- 4 Panel screws, 10-32, CPN 2120

1. Remove two end caps from the IC-150 front panel using the 7/64 Allen tool. Retain the socket screws removed.
2. Align the angle brackets (brushed surfaced toward the front) on the unit to match the holes which held the end caps. Secure angle brackets with 6-32 x 1/2 socket screws removed in Step 1.

NOTE

Socket screws may appear to be cross-threading but will straighten approximately halfway through.

3. Place a nylon washer on each panel screw and mount the IC-150 in a standard 19" rack with 10-32 threading. No supporting shelf is required.

3.4 AC POWER

The IC-150 is usually factory-wired for 120 VAC operation. However, the unit may be converted for 220 VAC operation by simply rewiring the power supply as shown in Figure 3-2. Only a soldering iron and a pair of diagonal wire cutters are required.

1. Remove the bottom cover from the IC-150 (paragraph 5.4.1).
2. With the unit upside down, and the front panel toward you, locate the terminal strip on the bottom in the near left-hand corner.
3. Cut two jumper wires; one between the white/orange and blue/yellow wires; one between the black and green/black wires.
4. Solder a new jumper wire between the blue/yellow and green/black wires at the terminal strip.
5. Replace the 1/8 ampere line fuse with a 1/16 ampere type 3AG fuse.
6. Change the line cord tag to read 220 volts.

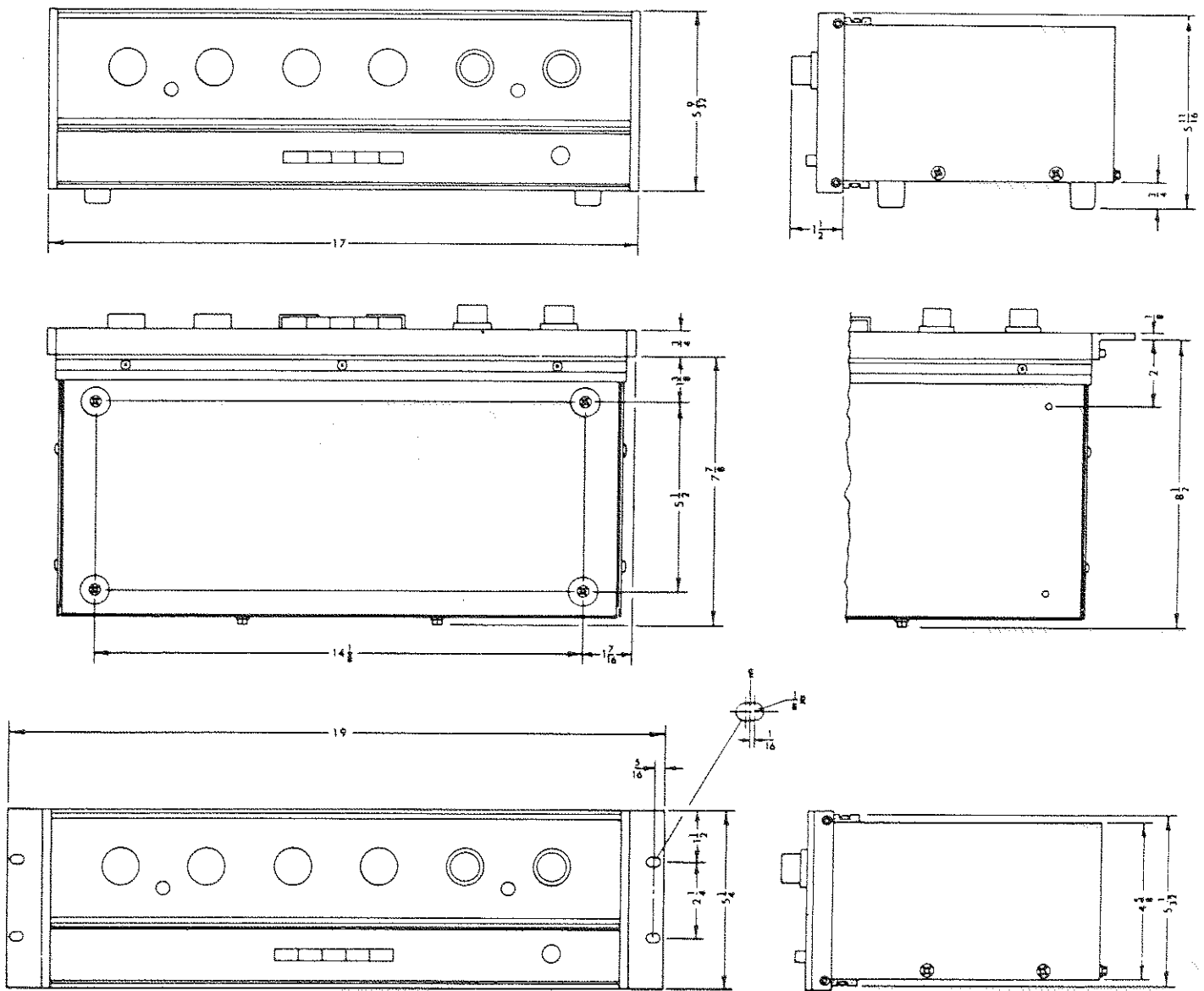

FIGURE 3-1. MOUNTING DIMENSION DIAGRAM

3.4.1 System Interconnections — IC-150 Stereo Console and Power Amplifiers

Power amplifiers used in the system with the IC-150 should be connected to the accessory AC receptacles on the IC-150, NOT a wall socket. Use 3-to-2 wire adapters supplied in the IC-150 accessory kit.

CAUTION!

Do NOT connect the green (ground) wires of the adapters to the IC-150 chassis. The shielded signal cables from the IC-150 output to your power amplifier carry the ground. Connecting the adapter green wires will cause "ground loops" and

result in hum, oscillation and possible amplifier and loud-speaker damage.

3.5 INPUT CONNECTIONS

Refer to Figure 3-3. Connectors for system equipment used as program sources for the IC-150 are located on the unit rear panel. Up to seven program sources may be connected simultaneously to the IC-150 and their outputs controlled by the 7-position SELECTOR switch on the IC-150 front panel. Refer to the manufacturer's instruction manual accompanying the program source equipment for proper control settings for each unit.

3.6 OUTPUT CONNECTIONS

Refer to Figure 3-4. Connectors for system equipment used as outputs for the IC-150 are located on the unit rear panel. Output connections are available for two tape recorders which may be used to record program material. Refer to the manufacturer's instruction manual accompanying the recorder for proper control settings on the recorder. Two main output connections are available for power amplifiers or headphone amplifiers.

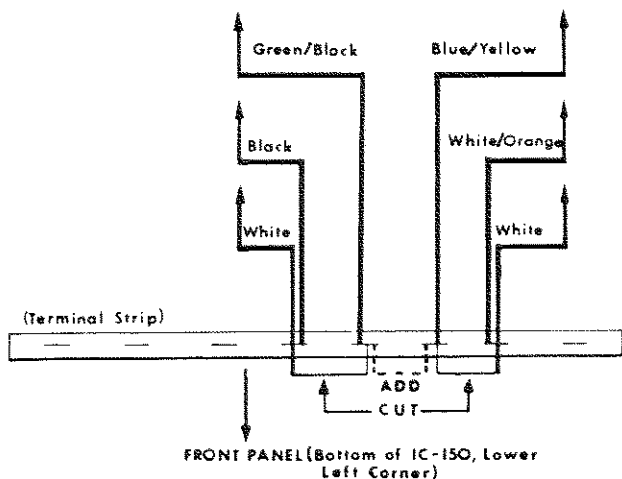

FIGURE 3-2. 220-VOLT WIRING CONVERSION DIAGRAM

3.7 DETAILED FUNCTION OF FRONT PANEL CONTROLS

Refer to Figure 3-5 for location and brief description of front panel controls. Detailed functional descriptions follow:

SELECTOR Rotary Seven Position Switch when operated chooses the sound source and recording source from phono, tuner, tape player, or recorder, TV sound, guitar amp, etc.

The **VOLUME** control with over 60db of dynamic range adjusts listening level of the program through your speakers. It does **not** affect the program fed to tape recorders. Notice the excellent channel-to-channel balance as the volume is raised or lowered.

BALANCE control usually remains at 12 o'clock for equal volume in each speaker. Turn the control toward the weaker channel to correct for unbalanced sound.

PANORAMA control supersedes the conventional mode selector-switch. You may smoothly vary the "stereo-image" from normal full stereo at "7 o'clock", toward mono, at "12 o'clock", then out to reverse-stereo, at "5 o'clock". This control helps reduce "ping-pong" stereo — particularly when using headphones.

BASS controls are continuously variable ± 15 db at 30Hz and are normally at 12 o'clock for "flat" response. Turn clockwise for increased low-frequencies, counter-clockwise for decreased bass.

(The larger control affects the left channel while the smaller, projecting knob controls the right. Each control is independent but may be easily operated in tandem by grasping both inner and outer knobs.)

TREBLE controls are continuously variable ± 15 db at 15KHz and are normally at 12 o'clock for "flat" response. Turn clockwise for increased high-frequencies, counter-clockwise for decreased bass. (The larger control affects the left channel while the smaller, projecting knob controls the right.)

TAPE MONITOR 1 and **TAPE MONITOR 2** provide instant replay from the "monitor" playhead of one or two typical 3-head recorders. In other words, you can listen to what you just taped.

LOW FILTER Button when depressed will roll off low frequencies at a 6db/octave rate below 50Hz (3db down-point). Sub-audio rumble is therefore reduced, without materially affecting the sound you hear.

HIGH FILTER Button when depressed will decrease the high frequencies at a sharp 12db/octave rate beginning at 5000Hz (3db down-point). Distorted, worn, and scratchy records benefit most with minimum loss of essential response.

ON-AC Button when depressed applies power to the IC-150 and simultaneously powers any component plugged into the switched AC outlets on the rear apron. Additionally, muting of the IC-150 output occurs for about four seconds after turn-on — thus eliminating "thumps" caused by most solid-state components. (NOTE: components **not** switched on by the ON-AC Button may not be muted unless turned-on within the four-second period.)

PUSH for LOUDNESS Button when engaged boosts bass and treble tones with respect to midrange tones at low sound levels. The amount of boost increases as the level drops. Disengaged, response remains flat (except for tone control and filter effects) at all sound levels.

PUSH for FLAT Button, when depressed, cancels all boost — or cut-action of both the **BASS** and **TREBLE** controls. Tone controls may therefore be "in" or "out" at a touch.

3.8 USING THE SELECTOR SWITCH AND TAPE RECORDERS

Refer to Figure 3-6.

- A. To hear a tape being played on Recorder 1, you may turn the **SELECTOR** to Tape 1 or push **TAPE MONITOR 1**. See Figure A.
- B. To hear a tape being played on Recorder 2, you may turn the **SELECTOR** to Tape 2 or push **TAPE MONITOR 2**. See Figure A.

WARNING!

Do not leave a Recorder in "Source" then turn IC-150 Selector either to or through that Recorder as oscillation will result.

- C. To record any source onto Recorder 1, turn the **SELECTOR** to that source. As an example, to record a disc being played on Phono 1 turn **SELECTOR** to Phono 1, you can even record the

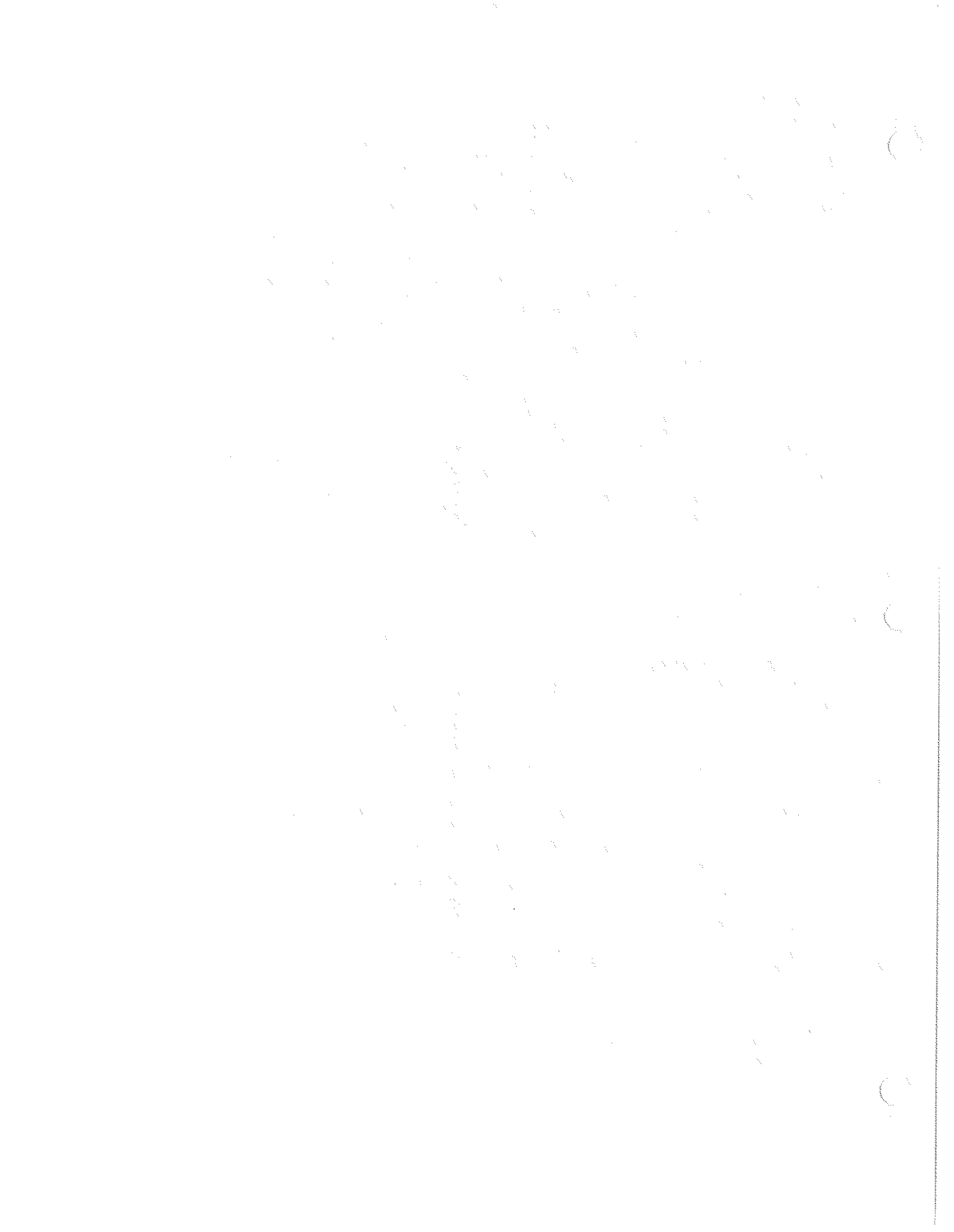

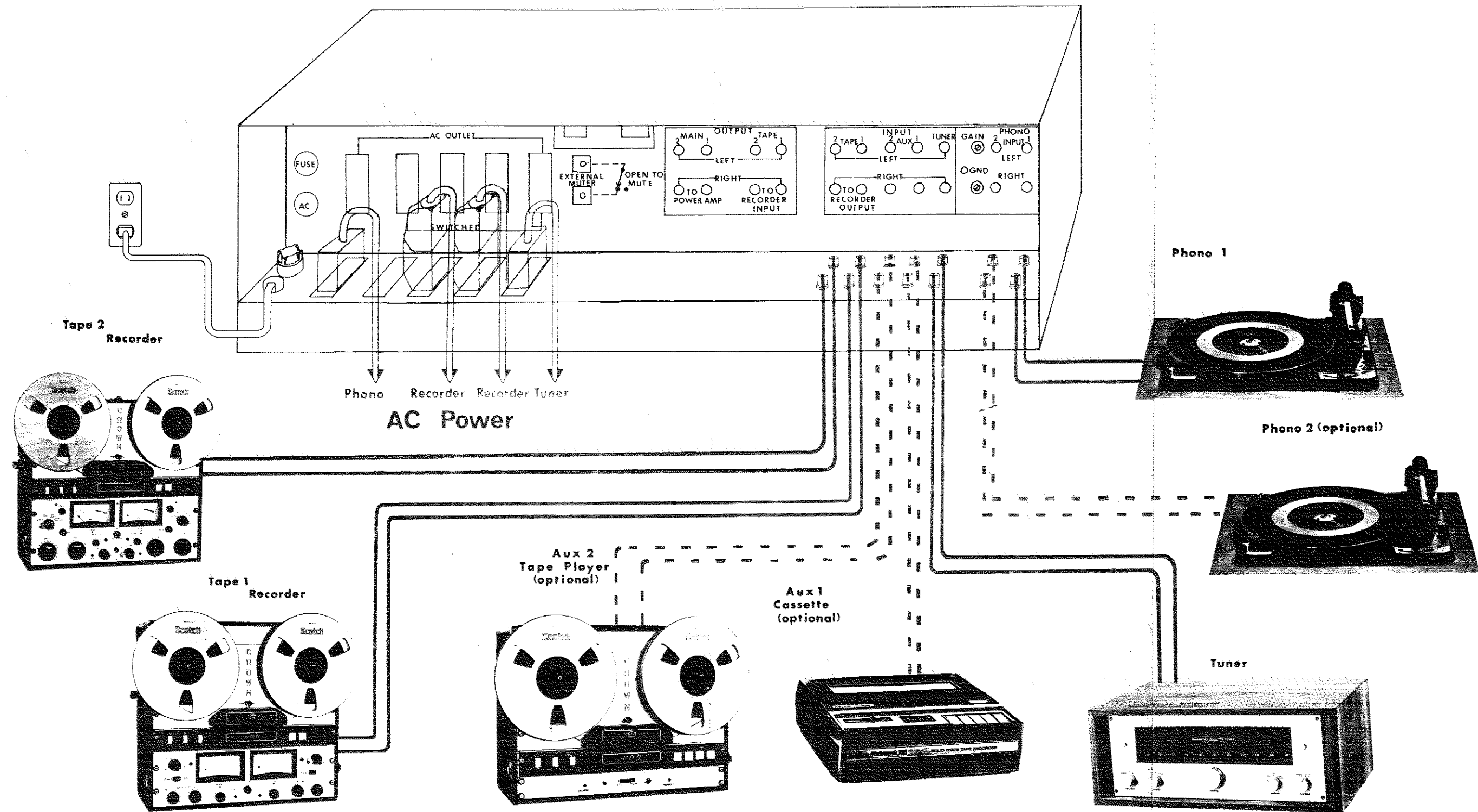

FIGURE 3-3. INPUT EQUIPMENT CONNECTION DIAGRAM

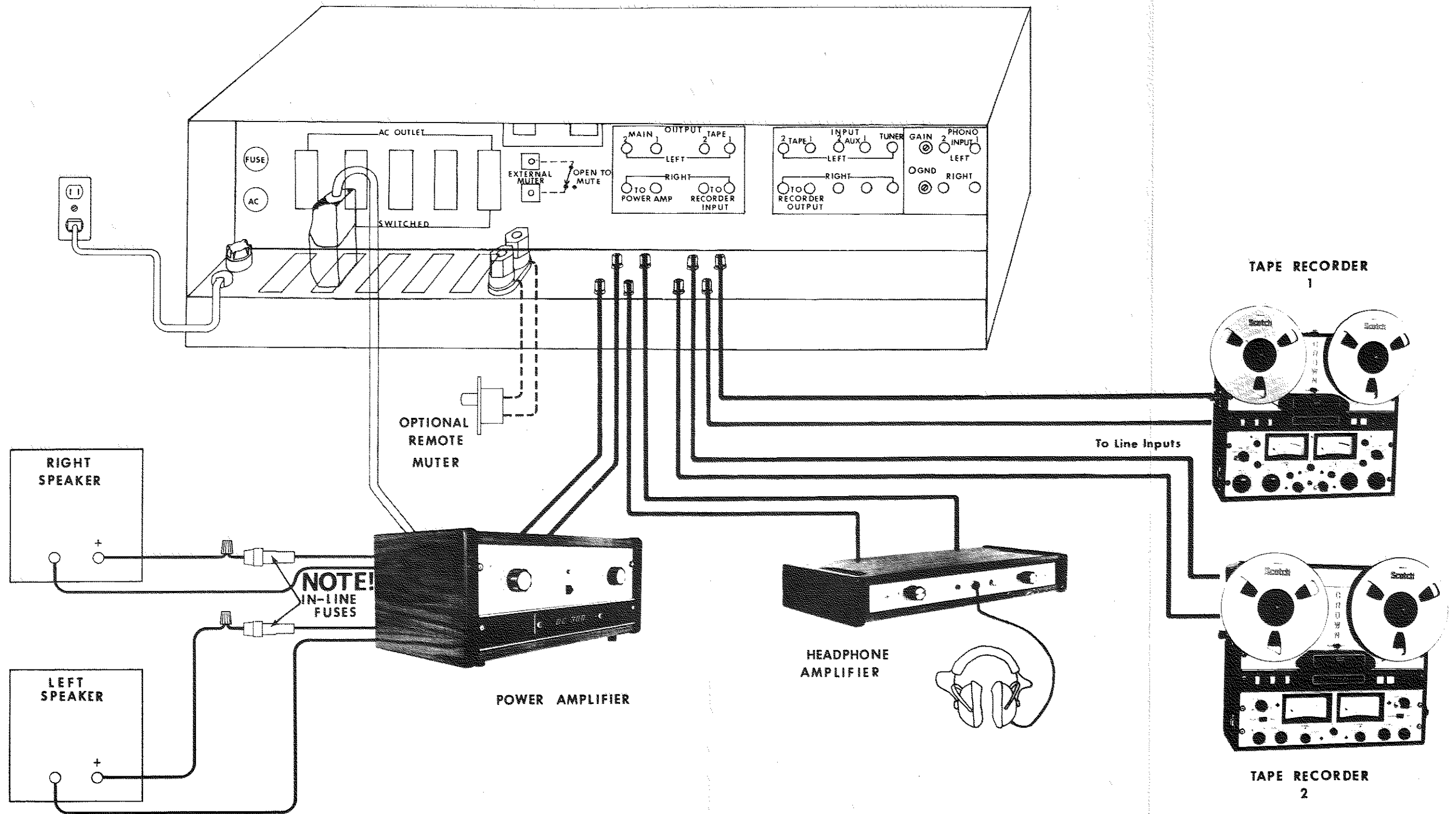
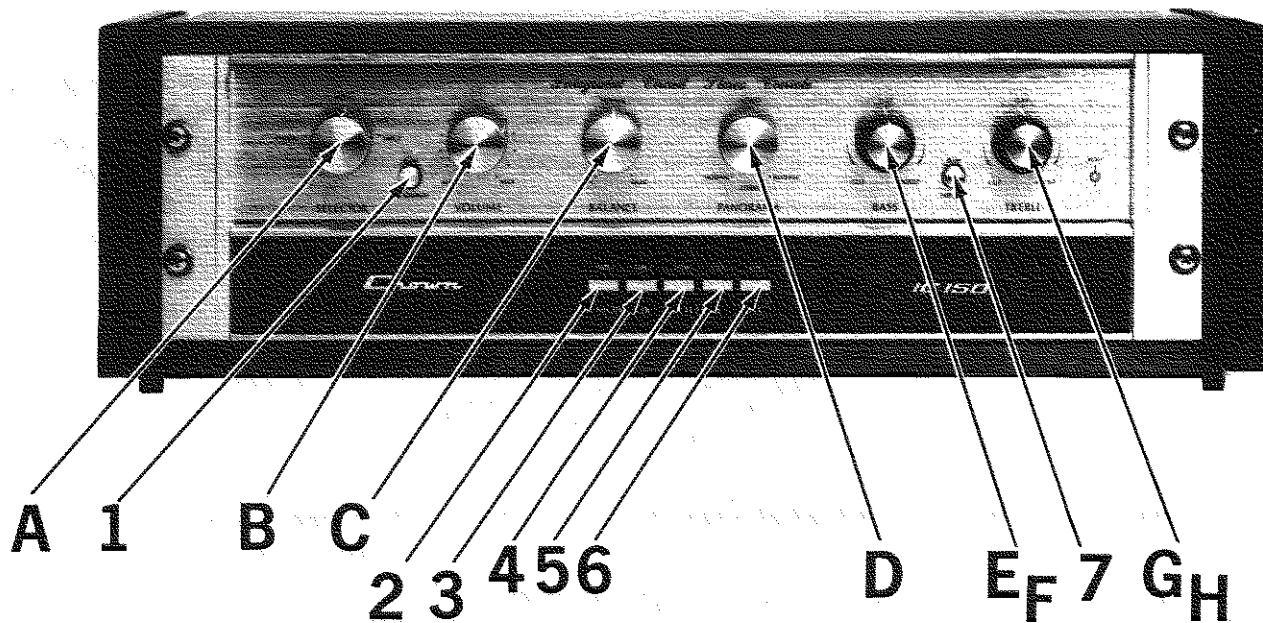

FIGURE 3-4. OUTPUT EQUIPMENT CONNECTION DIAGRAM



A — Selector knob

Phono 1 & 2 — for turntables, inputs have 50-70db gain, 47K ohms impedance and max. sensitivity of 1mv @ 1KHz.

Tuner — for FM Stereo/stereo multiplex or AM/FM Tuner.

AUX 1 & 2 — any device which can be connected to the AUX inputs, i.e. microphones, guitar, additional tuner, additional tape recorder, electric razor, etc.

Tape 1 & 2 — for tape recorders with 2 or 3 head configuration.

B — Volume — Adjust volume for your entire system.

C — Balance — Acts as a built-in equalizer for proper balance of your system.

D — Panorama — when in "Normal," music plays in stereo. "Mono" — for mono application. Each speaker puts out the same sound. "Reverse" all signals are switched. Signals which appeared in left channel will appear in right channel and vice versa.

1. Push for Loudness — when engaged adds loudness compensation to volume control; disengaged — response is flat at all volume levels.

2. Tape 1 — when engaged — monitors previously recorded material on Recorder 1.

3. Tape 2 — when engaged — monitors previously recorded material on Recorder 2.

4. Low Filter — eliminates low frequency noise or rumble when engaged. Disengaged — flat response.

5. Hi Filter — eliminates high frequency noise such as record scratches; disengaged — flat.

6. AC — turns on the complete system.

7. Push for Flat — engaged — cancels all tone control effects for perfectly flat response. It does not cancel scratch or rumble filters.

E-F — Bass Controls — inner knob controls bass prominence on right channel; outer knob, left channel.

G-H — Treble Controls — inner knob — controls treble prominence on right channel; outer knob, left channel.

FIGURE 3-5. IC-150 FRONT PANEL CONTROLS

play-back from Recorder 2 by turning the **SELECTOR** to Recorder 2. After setting the selector, please place Recorder 1 in the source mode and push **TAPE MONITOR 1**. Adjust Recorder 1 input levels, then adjust the output levels until volume is unchanged whether **TAPE MONITOR 1** is depressed or not. Begin taping, then switch the source-tape switches of Recorder 1 to "TAPE" releasing and depressing the **TAPE MONITOR 1** will now yield the "Source-Tape" A-B comparison. You can also leave the **TAPE MONITOR 1** depressed and A-B the recording at the machine. See Figure C.

D. As with Recorder 1 described in C, any source can be taped on Recorder 2 including playback of Recorder 1. Further, any source on the **SELECTOR** (except Recorder 1 or 2) may be taped on both recorders simultaneously and monitored in-

dividually using **TAPE MONITOR 1 OR 2** (if 1 and 2 are depressed together, 2 will override 1).

E. While taping on Recorder 1, it is also possible to listen to a completely different tape on Recorder 2 by depressing **TAPE MONITOR 2**.

As **TAPE MONITOR 2** overrides **TAPE MONITOR 1**, for easy monitoring we suggest method E; however, the following method may be used.

F. It is possible to record from any source on the **SELECTOR** with the exception of Tape 2 onto Recorder 2 while listening to Recorder 1. First, set-up Recorder 2 as in C above. Second, to hear Recorder 1 playback, disengage **TAPE MONITOR 2** and engage **TAPE MONITOR 1**.

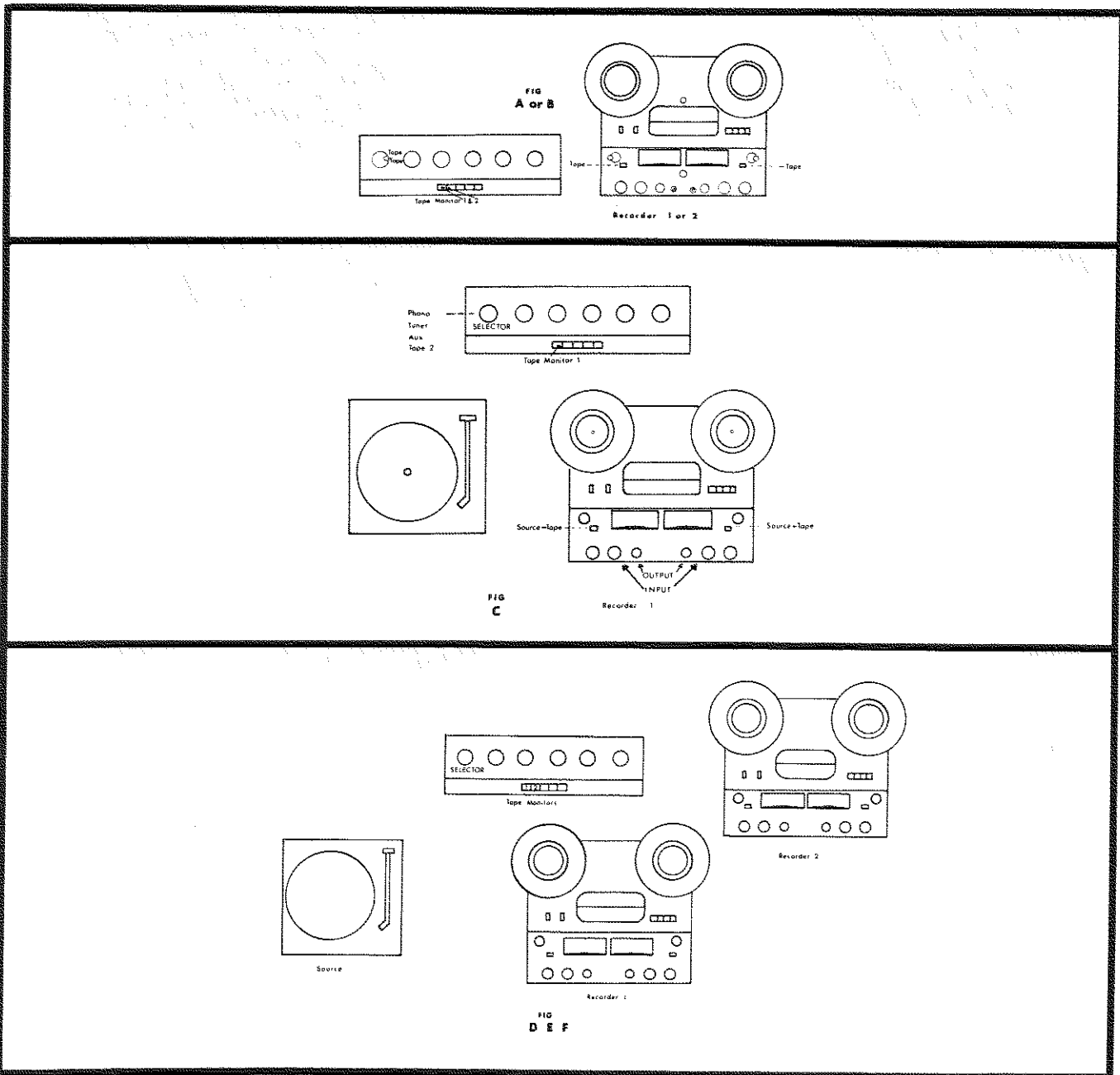

FIGURE 3-6. SELECTOR SWITCH — TAPE RECORDERS

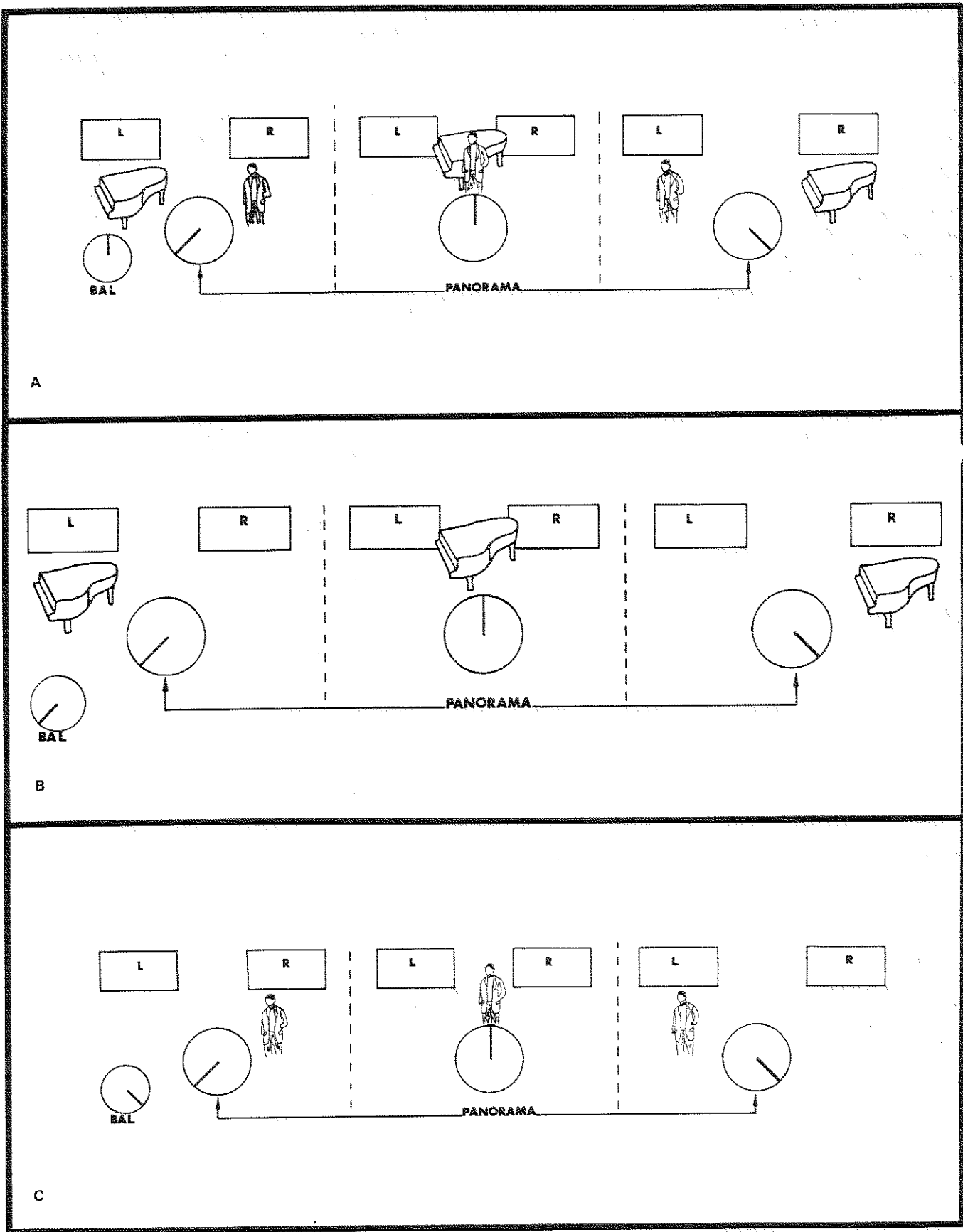

FIGURE 3-7. PANORAMA / BALANCE CONTROL

3.9 COMBINED FUNCTION OF THE PANORAMA AND BALANCE CONTROL

An important part of the unusual flexibility of the IC-150 is illustrated in Figure 3-7.

The pictures show the variation in balance (relative source levels of the two channels) and the stereo image (locations from which the sounds seem to be coming) available through use of the **BALANCE** and **PANORAMA** controls. The musical example pictured has a piano (it looks like Peter Nero's) in the left channel, accompanied by a singer (probably Robert Goulet) in the right channel. Starting at the left, both controls are shown in the **NORMAL** position. With this setting it is possible that the musical source, the reproducing equipment, and the surrounding acoustics will together allow the piano and voice to sound balanced (i.e., neither is obscuring the other) and distinctly separated in distance (i.e., perhaps the singer appears to be in the middle of the stage while the piano is off to the left). If this is true, the controls can be left in the **NORMAL** position and life is astonishingly easy. Imagine, however, that a poorly made recording gives you the feeling that the singer is performing on your patio off to the right, while the piano is being played in your neighbor's lawn across the street to the left. This is too much separation. By moving the **PANORAMA** control toward the **MONO** position (Figure 3-7, A) you can move the two channels together until you are satisfied with the sound. Moving all the way to the **MONO** position mixes the two channels completely, giving no separation (i.e., the singer will be sitting on the piano a la Dean Martin). If you would rather have the piano on the right and the singer on the left, this can be accomplished by turning the **PANORAMA** control to the **REVERSE** position, as in the third picture.

Figure 3-7, B illustrates the effect of moving the balance control toward the left position. Suppose that after listening to the music, it seems to you that the singer is dominating the piano too much. By turning the balance control toward the left position you can decrease the vocal contribution from the right channel until you feel satisfied with the relative levels of piano and voice. If you want to hear only the piano, turn the **BALANCE** all the way to the **LEFT** position, at which point the singer (right channel) will be turned off completely, and the piano will continue alone on the left. If you then move the **PANORAMA** control toward the **MONO** position, the piano will seem to move toward the right. At the **MONO** position, the sound of the piano will be coming at equal volume levels from both speakers. If you turn the control toward the **REVERSE** position, the piano will move further to the right, until it appears solely in the right channel. The piano has duplicated its movement in the top row of pictures, but without the vocal accompaniment.

Figure 3-7, C shows the same process in the right channel. Perhaps you decide that the singer needs more emphasis. Turning the **BALANCE** control toward the **RIGHT** will decrease the piano volume until the relative levels are satisfactory. At the **RIGHT** position, the piano (left channel) will be completely gone, and the singer will appear alone in the right channel. You can then use the **PANORAMA** control to move the singer to any position between the right and left channels, as shown in the succeeding two illustrations.

Notice that in the three pictures showing the **PANORAMA** control in the **MONO** position, that the sound comes from a single location between the speakers, regardless of the **BALANCE** control position. This occurs because the **BALANCE** control appears before the **PANORAMA** control in the circuit, an arrangement which means that the **BALANCE** control does not operate on the mixed signal coming from the **PANORAMA** control. It also means that any **BALANCE** change will affect both speakers equally when the **PANORAMA** control is in the **MONO** position. If, for example, you decrease the sound of the piano by turning the **BALANCE** control toward the **RIGHT**, the sound will decrease equally in both speakers. The need for flexibility dictates this design. Using the level controls on your power amplifiers still allows you to vary the sound level from both speakers if you want, while the location of the **BALANCE** control before the **PANORAMA** control allows you to vary the levels of the individual channels before mixing is done by the **PANORAMA** control. This way, the **BALANCE** control and the amplifier level controls do not merely duplicate each other, but accomplish different functions, thereby adding another dimension to your control of the music.

The result of the IC-150 is an unparalleled capability for fitting your music, components, and environment together in a satisfying way.

3.10 USING THE EXTERNAL MUTER

The external muter shown in Figure 3-4 is a very simple device to use. As a suggestion, the switch could be conveniently installed beside a telephone, thus eliminating the risk of falls when running at high speeds from the stereo to the telephone.

By installing a single pole, single throw, "on/off" type switch with any length of "zip cord", remote muting may be achieved.

To install, simply loosen the hex nuts on the muter, remove the jumper wire installed by the factory. Wrap either wire attached to the switch to either lug on the muter, then retighten the external muter nuts (see Figure 3-8).

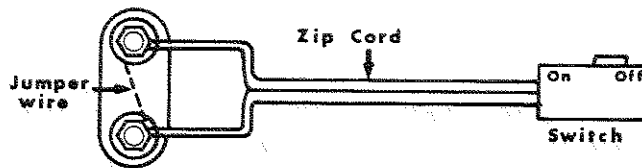

FIGURE 3-8. EXTERNAL MUTER WIRING

4.1 GENERAL

This section contains a description of circuitry operation to better enable a qualified service technician to understand and maintain the CROWN IC-150 stereo console in optimum operating condition. Refer to Figure 4-1 (IC-150 Signal Flow Diagram) and the overall unit schematic diagram in Section 6 while reading the circuitry description to facilitate your understanding of the unit operation.

4.2 PRINCIPLES OF OPERATION

The IC-150 provides the important basic control center functions in a unit designed for clean sound and uncomplicated operation. Especially noteworthy qualities include the uniquely low distortion and noise levels, and the exceptionally good frequency and phase response. These qualities combine with simple and precise mechanical operation to afford versatile handling of programs from all audio sources.

The electronics of the IC-150 are built around two integrated circuits which provide the equivalent of 22 transistors and 14 diodes. Beside these there are 13 bipolar transistors, 1 FET, 2 zeners, and 8 diodes.

The IC-150 requires about 2 watts for its operation. The power supply can be wired for 120 or 240 volts, and will operate on any frequency from 50Hz-400Hz. On the back of the unit are provided 5 ac outlets for supplying equipment used with the preamp. Four of these are powered by the on-off switch of the IC-150, while the fifth is wired directly to the power cord before the switch. The unswitched outlet powers your turntable, to avoid turn off in mid-cycle with possible damage.

The output from the IC-150 to the following amplifier is automatically muted for several seconds to protect speakers. When the IC-150 is turned on, a relay keeps the output off long enough to allow normal turn-on transients in other equipment to die down, thus preventing these transients from harming speakers. About 5 seconds after the ac switch is pressed, the muting relay closes to allow normal operation.

A conceptual layout of the operation of the IC-150 appears in the signal flow diagram. For any who want more detail the actual electronic components are shown on the schematic. The signal flow diagram shows the sequence of operations upon an audio signal as it passes from input to output (moving from left to right on the diagram).

At the extreme left of the chart the selection of inputs appears, all of which feed to the rotary selector switch. If the phono inputs are used, the signal goes through the selector switch to the phono preamp and employs a low-distortion, low-noise cascode design. Other features of the phono preamp include the equalization circuitry (to afford precise matching of the RIAA response curve) and the phono level controls. Following the phono preamp the signal is returned to the selector switch.

From the selector switch, the signal (either from the phono preamp or from tape, aux, or tuner inputs) goes to the tape outputs and the tape monitor circuitry. The tape outputs route the signal to your recorder(s), while the pushbutton activated tape monitors provide a means of listening to whatever is coming into the Tape 1 and Tape 2 inputs when the selector switch is set on a different input (you may monitor the tape you are making, comparing the tape with the source you are taping). The next part of the circuit is the low filter, which is normally bypassed. It can be added to the circuit by depressing the low filter button.

Following the low filter come the volume control and loudness circuitry. Depressing the loudness button adds the loudness compensation circuitry to the signal path. When the volume control is turned to maximum, the loudness compensation has no effect. As the volume control is turned down, the compensation prevents the bass and treble tones from attenuating as quickly as the mid range tones. This provides the boost necessary to keep the loudness levels balanced. When the loudness button is out, the loudness circuitry does not affect the signal at all.

The next controls affect the stereo image of your music. The first of these, the balance control, works by attenuating one channel while maintaining the level of the other. At the extreme positions of the knob, one channel is at the level set by the volume control while the other is completely off. In between, the relative volume levels of the two channels may be set in any combination which suits the surroundings of a particular system. At any setting, complete separation is maintained between the two channels.

The pan control allows you to mix the signals of the two channels in any combination from normal stereo to reverse stereo. In the "Normal" position, the left and right channels appear normally, with complete separation. As the control is turned away from normal, the two channels begin to mix, until at the "Mono" position, the channels are completely mixed and there is no difference between the right and left outputs. Continuing to turn the control increases separation again, but so that the original left channel begins to appear at the right channel output, and the original right channel appears at the left. At the "Reverse" position the two channels have been completely separated in the reverse position. The control thus offers complete freedom to mix the channels to the degree that suits your personal musical tastes.

Immediately following the pan control is the main amplifier section of the IC-150. Employing a quiet, low-distortion integrated circuit in an operational amplifier configuration, the circuit amplifies signal voltage by 20.8db. The bass and treble controls appear in the feedback circuitry of the main amplifier. These are designed to provide a wide dynamic range, and allow control of the 20Hz and 20KHz frequencies in excess of ± 15 db. By depressing the "push-for-flat" button, the tone controls can be completely cancelled, and a flat frequency response obtained regardless of the tone control settings.

The final section of circuitry which helps shape the signal is the high filter. As with the low filter, it is normally bypassed, and only affects the signal when the high filter button is pushed.

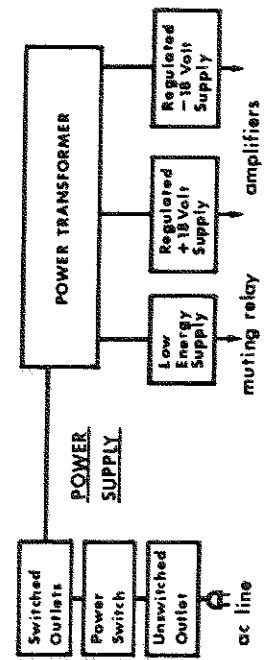
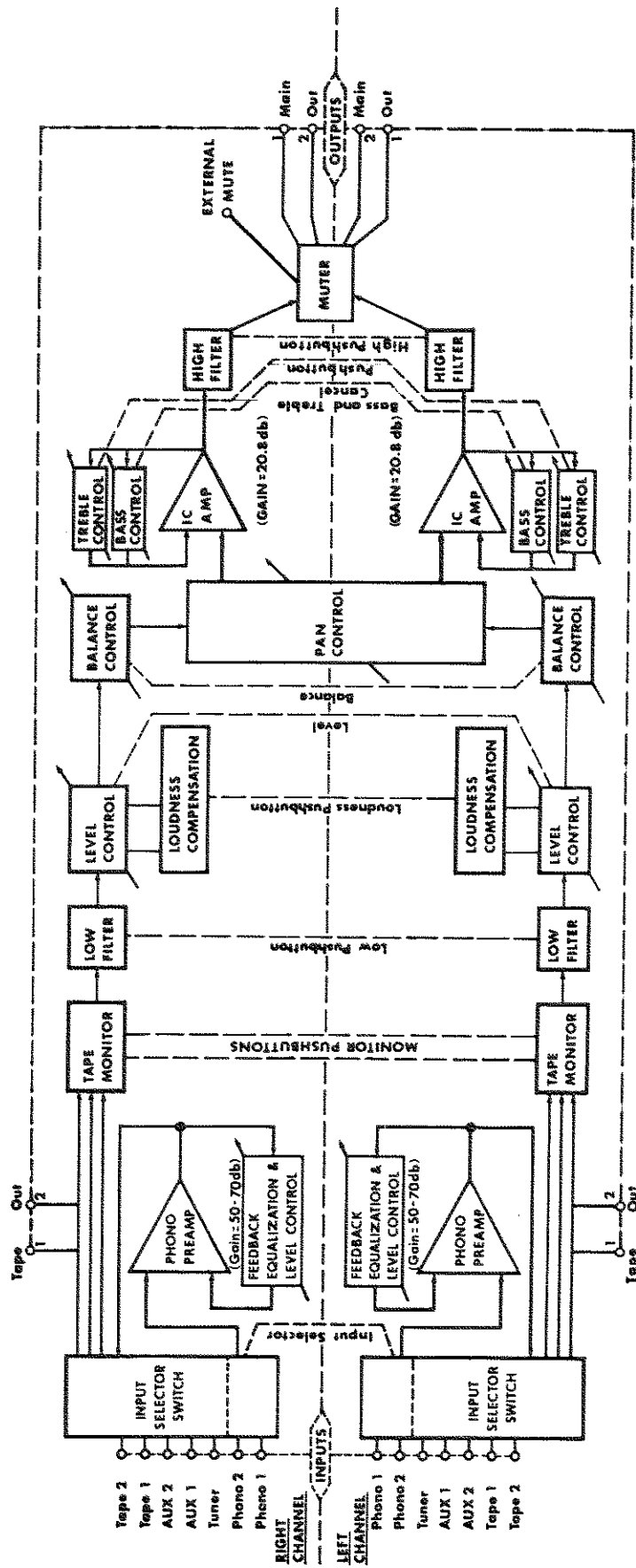

FIGURE 4-1. IC-150 STEREO CONSOLE, SIGNAL FLOW DIAGRAM

The last active circuitry before the output terminals is the muting circuit. When power is initially applied to the IC-150, the muting relay contacts tie the output to ground. The muting relay remains in a relaxed state until an RC circuit charges and turns on an FET, which in turn energizes the relay and removes the short from the output. This process absorbs approximately 5 seconds, time during which turn-on transients can die out before the speakers are connected to the circuit.

The power supply includes 3 separate dc supplies to operate the IC-150. Regulated positive and negative 18 volt supplies go to the operational amplifier and the phono preamp. Besides these, a third low-energy supply is provided for the muting circuit.

4.3 INPUT CIRCUITRY

The availability and functions of the different inputs and outputs have been incidentally described in earlier parts of the manual. A few more details with a bit more organization seem to be in order.

Altogether there are seven inputs available covering turntables, tape decks, tuners, and whatever you want in the auxiliary inputs. Particular facts about these inputs include the following:

4.3.1 High Level Inputs

The five high level inputs (tape, tuner, aux) show an input impedance of 100K ohms. The gain from these inputs to the main outputs is set at $20.8\text{db} \pm 0.2\text{db}$ (i.e. with the volume control at maximum, 0.5 volts in will get you about 5.5 volts out).

4.3.2 Phono Inputs

The two phono inputs have been equalized to match the RIAA standard response curve. Their input impedance measures 47K ohms. In order to adapt to different turntables and cartridges, the gain of the phono preamp has been made adjustable between approximately 30db and 50db which adds to the main preamp to give a total gain of 50-70db (1KHz). Two small screwdriver-adjusted pots, mounted on the back of the unit next to the phono inputs, provide the means of separately adjusting the gain of each channel.

The phono level controls are set during the final factory check of the IC-150 to give a total preamp gain of 60db. This setting in the middle of the range proves satisfactory for most stereo cartridges. The gain adjustment should not usually have to be altered. Situations which may require gain adjustment include voltage overloading from unusually high voltage cartridges, low tape-output levels from cartridges with unusually low voltages and cartridges with unbalanced channels. The level controls may also be used to balance the volume levels of different inputs to the IC-150 (i.e. to match the level of the turntable to the level of the tuner, etc.).

In general, phono overloading should not be a problem. Depending upon the gain setting, the overload point will vary. If the phono gain is turned to its maximum of 50db, a signal of 33mv will produce about 10 volts out, which is the maximum available. With the gain turned to its minimum of 30db, it takes 330mv in to produce the maximum 10 volts out. The phono overload level therefore

varies between these two limits. At the factory setting of approximately 40db, the overload level is about 100mv. To demonstrate the range this gives, consider the case of a fairly standard phono cartridge with an output of 8mv at a needle velocity of 5.5 cm/sec. An LP record may produce peak velocities of about 30 cm/sec., which will in turn produce maximum voltages from the above cartridge in the range of 45mv. At the preset phono gain of 40db, the maximum cartridge output remains substantially below the overload voltage of 100mv.

The comparative signal levels at input and output appear graphically below. The comparative level chart gives some sample signal levels and shows the range of gain available in the phono preamp as well as the main preamp.

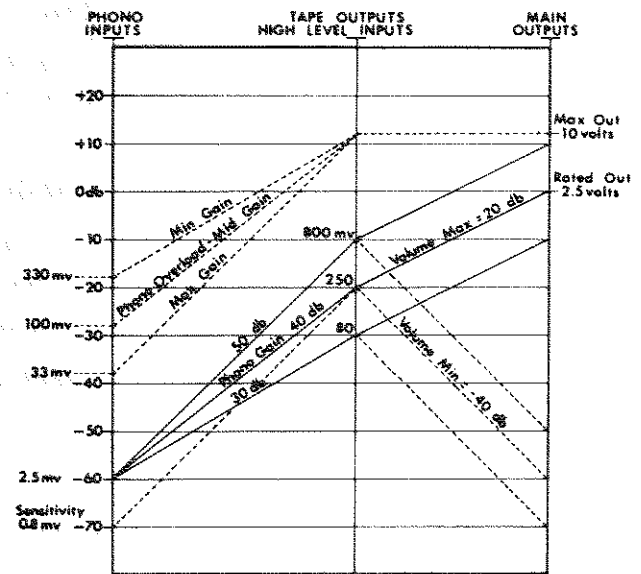

FIGURE 4-2. IC-150 COMPARATIVE SIGNAL LEVELS

4.4 OUTPUT CIRCUITRY

4.4.1 Main Output

The main outputs are rated at 2.5 volts, with a maximum output of 10 volts. Output impedance measures 600 ohms. In the event that the IC-150 is employed to drive a 600 ohm load, it will typically produce 5 volts rms into this impedance.

4.4.2 Tape Outputs

The tape outputs (output of the phono preamp) typically produce 9-10 volts (rms) maximum output at 1KHz into a high impedance load. (In the following discussion of frequency response, a graph of the typical maximum phono output from 20Hz to 20KHz is included.) These outputs also show a 600 ohm output impedance.

We get music into and out of the IC-150 through the avenues just considered. Next is a description of what happens to the music between the inputs and outputs.

4.5 FREQUENCY RESPONSE

No electronics equipment gives all frequencies equal treatment. If you look at some frequency response graphs, you will notice that the usual pattern for audio equipment shows deviations from the set level at high and low frequencies — depending on the equipment, there may be other deviations in between. To get the information for these graphs, the test level (usually 1 watt output for power amps, and rated output voltage for preamps) is set at 1 KHz (1000Hz). The test signal frequency is varied above and below this frequency, and the resulting changes in output level are graphed according to the frequencies at which they occur. The term "flat" indicates the set level. An amplifier "flat from 20Hz to 20KHz" is one which does not deviate significantly from its set level between the frequencies indicated. Any departure from the flat level simply means that, at the frequency where the departure occurs, the equipment is amplifying the signal either more or less than it is amplifying the 1KHz signal. If the response is down 2db at 50Hz,

the 50Hz signal is getting 2db less amplification than the 1KHz signal. Depending on circumstances, you can probably detect a change of from 1 to 3db in sound intensity, which means that a 2db drop in the low frequency range would be noticeable in a production where low frequencies were an important part of the music. The ideal then would be a completely flat response curve over the entire range of audible frequencies (about 20Hz to 20KHz).

Theoretically, a piece of equipment will retain its frequency response at all levels from the test level to its rated maximum level. In real life, theoretical projections have a way of passing away like the morning dew. And so it happens that some power amplifiers which perform beautifully at 1 watt levels will self-destruct if extreme frequencies (20Hz or 20KHz) are delivered to them at their rated power levels. It is sometimes very worthwhile and informative to look at a power response test as well as the usual frequency response test for amplifiers. Preamps live among similar

FREQUENCY RESPONSE

- Hi-Level: + 0.6db 3Hz-100KHz with hi-impedance load (1 meg, 0pf).
- + 0.1db 10Hz-20KHz with IHF load (100k parallel with 1000pf).
- Phono: + 0.5db from RIAA standard response curve.

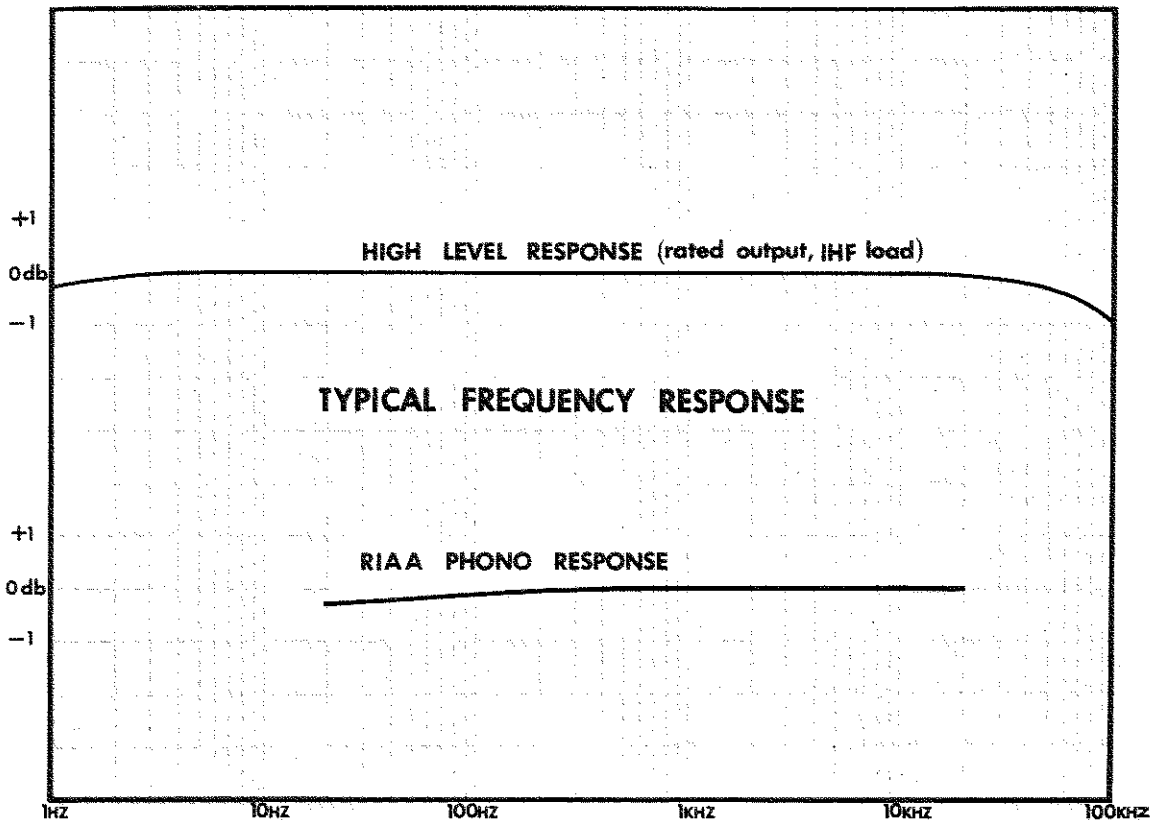

FIGURE 4-3. TYPICAL FREQUENCY RESPONSE

limitations and a good response curve at the rated output level (for the IC-150, this is 2.5 volts), may fall apart when the record you are playing through the phono input is trying to push the preamp output to 8 volts at 15KHz. The IC-150 has been designed to maintain its ability to produce clean, high level signals even at the extreme frequencies of the audio range. A maximum response curve of this sort is shown below along with the usual response curve taken at 2.5 volts out.

Part of the information on the response graph (Figure 4-4) is the RIAA response of the phono preamp. The title doesn't help much but this is simply a response curve taken through the phono

preamp by itself instead of through the main preamp. Because of the way records are cut, they do not have a flat frequency characteristic. In the light of this situation, phono preamps need a special compensating response curve that is not flat. The RIAA (or Record Industries Association of America, the organization that sets up standards for phono response so that everyone's records can be played on everyone else's stereo systems) response indicates what should come out of the preamp when a record is played through it. The response of the preamp should cancel the effects of the record-cutter so that the resulting output is flat with the frequencies balanced as in the original production.

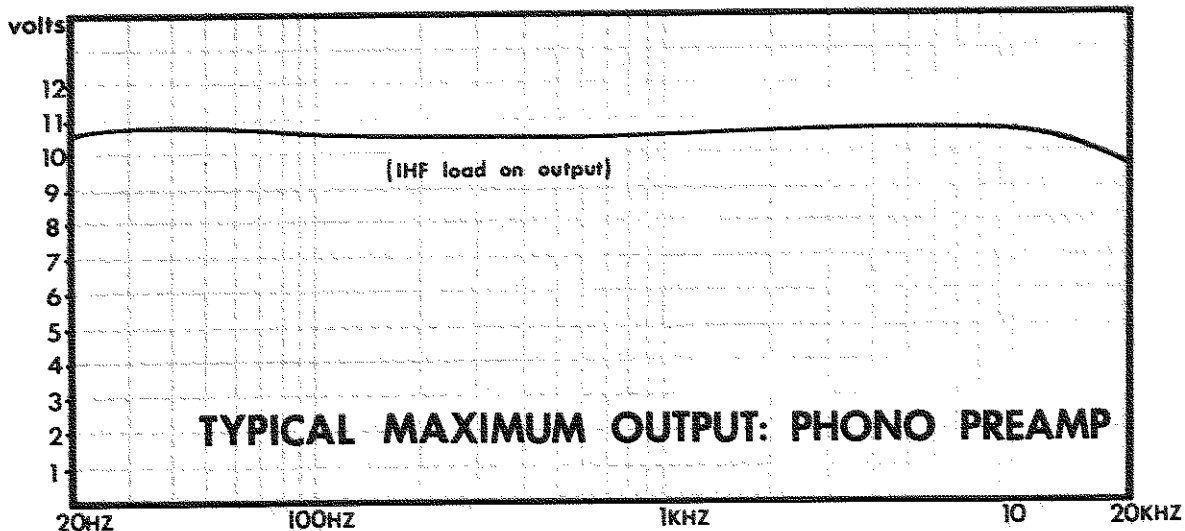

FIGURE 4-4. TYPICAL MAXIMUM OUTPUT: PHONO PREAMP

4.6 VOLUME CONTROL AND LOUDNESS CONTROL

We have just told you that the ideal response curve at which everyone aims is perfectly flat from 20Hz to 20KHz. Now we're going to tell you something different. Unfortunately (and this is why good audio systems may end up with a bewildering array of knobs, switches, buttons, and other special effects), this is not ideally true. In fact, the most desirable response at many sound levels is not flat at all, and your own personal tastes (i.e. do you like drums or piccolos better?) may decree that your desired response will not be flat at any listening level.

But so that you have a good foundation upon which to operate in satisfying your own musical tastes, it is necessary to have a flat response to begin with. From this point, you can move out according to the dictates of your own ears, by using the loudness control, tone controls, and filters. The loudness control compensates for a characteristic which appears in everyone's hearing, while the tone controls and filters are planned to adjust the sound to fit your audio equipment, your music, and your tastes.

Without the loudness compensation, the volume control should preserve the frequency response (shown above) anywhere in its range. In other words, the response should duplicate the above graph whether you are listening to a high or low volume level. At fairly high levels (comparable to a good seat at a live performance), this is fine because the balance that you hear between the different tones approaches the balance of a live performance. But as you turn the volume down, it becomes evident that the low frequencies and the high frequencies fade from your hearing much faster than do the midrange frequencies. This phenomenon derives from the non-uniform response of your ears. Please don't assume we're insulting your ears. It is simply true that at low sound levels, you do not hear low and high frequency tones as well as you hear mid-range tones. The set of curves below shows how your hearing changes with frequency change. These curves were obtained by having a group of listeners compare tones of other frequencies with a 1KHz reference tone. The other frequencies were increased in loudness until the listeners felt they were as loud as the reference. This particular set of curves comes from the

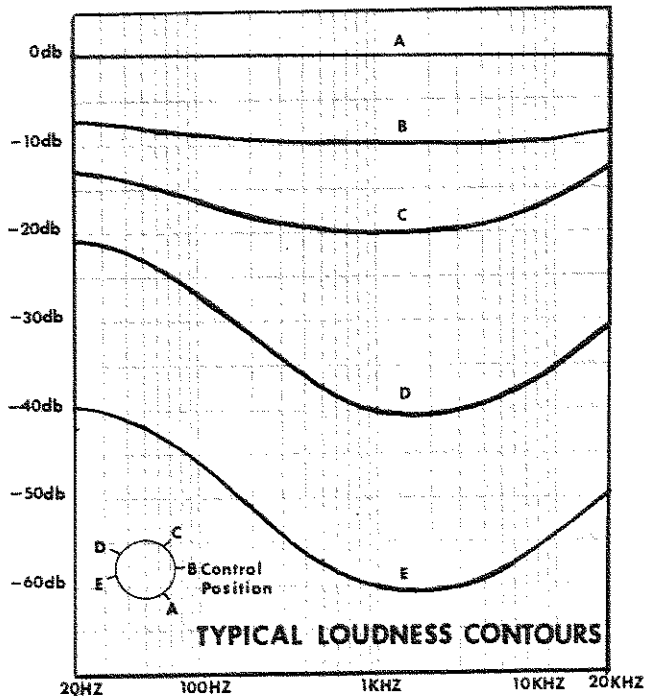

FIGURE 4-5. TYPICAL LOUDNESS CONTOURS

research of men named Fletcher and Munson (from which derives their highly imaginative title!). As a particular example, observe that the line which crosses the 40db line at the 1KHz frequency

climbs to the left until it reaches the 78db level at 30 cycles. This indicates that the 30 cycle tones would have to be boosted by 38db to maintain equal loudness with the 1 KHz tones at this sound level. The loudness compensation circuitry of a preamplifier provides this boost in the low and high frequencies in order to make the loudness of each frequency match the loudness of the 1 KHz tone. When the loudness compensation is engaged (by pushing the loudness button), the volume control then affects the loudness according to the curves shown above with greater bass and treble emphasis occurring as the level is turned down. At low levels, then, the actual response is no longer flat but what you hear will sound flat because you've got human ears. Clever, right?

4.7 TONE CONTROLS AND FILTERS

The loudness control is largely a response to the natural character of everyone's hearing. The tone controls and filters on audio equipment are more personal. They exist to enable you as the listener and final critic to mess around with the sound of your system until you like it. The controls are reasonably named in accordance with their function. The bass control makes it possible for you to increase or decrease the level of bass you are hearing. The treble control similarly handles the treble tones. Besides these controls there are two buttons designed to cut down the bad effects of some system problems. The rumble (low) filter acts to eliminate unwanted low frequencies that may appear in your system (through the turntable mechanism, for instance). The scratch (high) filter acts to eliminate high frequency peculiarities (such as scratches on your records). Use of these filters necessarily cuts down the high and/or low frequency response, but this in some cases sounds much better than listening to the faithful reproduction of turntable indigestion or the results of record torture by bouncing tone arms.

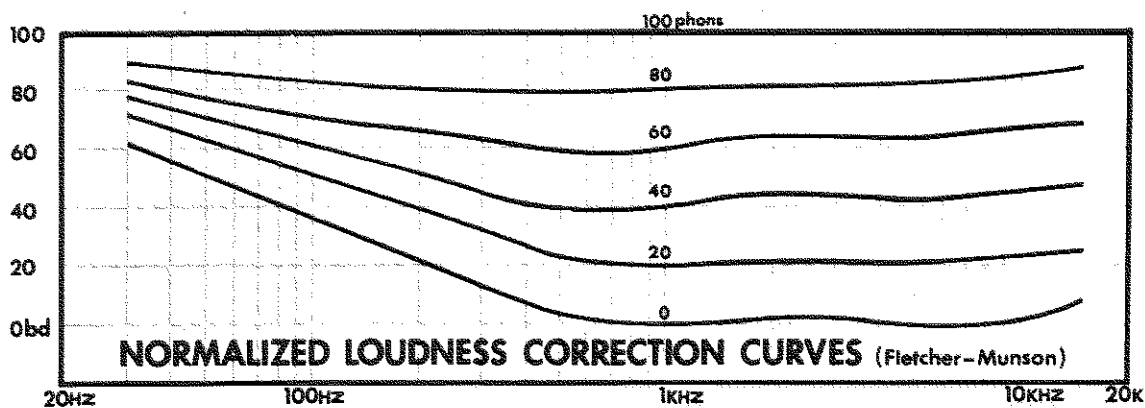

FIGURE 4-6. NORMALIZED LOUDNESS CORRECTION CURVES

The curves shown for these controls give an idea of their effect on the program being passed through the preamp. The curve labels are intended to show where the control knob should be set to result in a given amount of increase or decrease in sound. Full boost on the bass, for example, means the bass knob will be turned all the way clockwise (to about the 5 o'clock position). This will add 8db to the 100Hz signal. The 50Hz signal will be boosted 13db and the 20Hz signal will be increased by 22db. One-half boost curves apply when the control knob is turned approximately half way between the flat position and the full-boost position. Going the other way, the bass control will lower the volume of the bass end of your program. The treble end can be emphasized or cut back similarly by use of the treble knobs.

Depressing the "PUSH FOR FLAT" button cancels the effects of the tone controls (but not the filters).

The low filter drops the output 3db below the flat level at about 70Hz, which, as a point of reference, appears at the low end of the range of a cello. (This is affected by the setting of the volume control, with maximum filtering occurring at full volume when unwanted low frequencies are most likely to be audible.) A loss of 3db in output level represents a fifty percent loss of power (but not necessarily a 50% loss in loudness). The filter then cuts off frequencies below 70Hz at a rate of 6db per octave, which means that the level drops 6db each time the frequency goes down by one-half (i.e. there will be a 6db drop between 40Hz and 20Hz, etc.). A 6db loss cuts the power by a factor of 4.

The high filter hits its 3db down point at 5KHz. For reference, the high end of a piccolo's range is about 4.2KHz. Above this, the filter cuts the signal at a rate of 12db per octave, (i.e. the power will drop by 12db, or a factor of 16, between 6KHz and 12KHz, etc.).

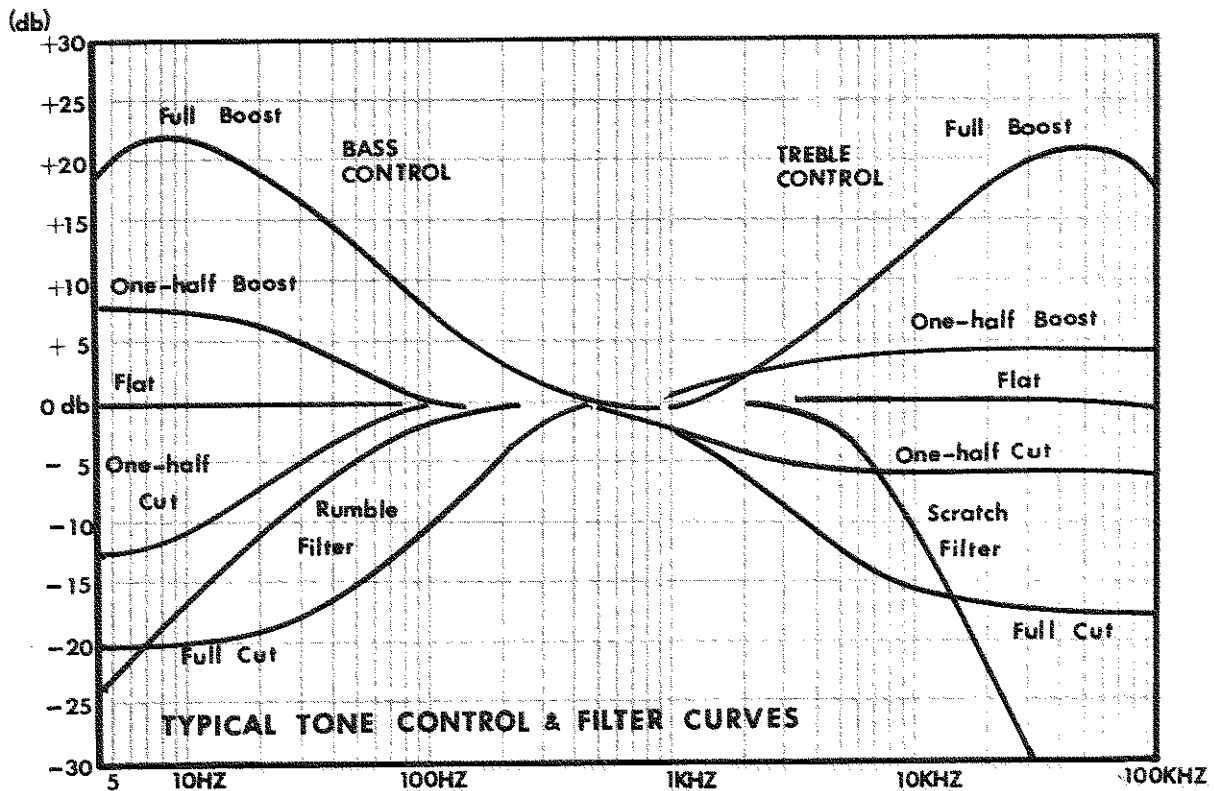

FIGURE 4-7. TYPICAL TONE CONTROL AND FILTER CURVES

4.8 PHASE RESPONSE

This particular characteristic of audio systems has not been much emphasized. Its effect is not easy to describe accurately, since poor phase response does not produce the obvious aberrations heard with high distortion or bad frequency response. The need for good phase response appears with the desire to hear musical instruments sound as they do in the concert hall. Each instrument has its own peculiar sound, made up essentially of the particular note being sounded plus its harmonics. If the middle A on a piano is being sounded, for instance, the fundamental tone (and first harmonic) is 440Hz. The second harmonic is 880Hz, the third is 1320Hz, and so on. The particular sound of each instrument derives from the relative amplitudes of the various harmonics associated with the fundamental tone. For example, if the second harmonic is much louder than the third harmonic, the note will

sound different than would the same note with a louder third harmonic. That's why trumpets and piccolos and police whistles don't sound the same, even if they can hit the same note. Any change in the relationship of these harmonic tones to one another and to the fundamental will produce a change in sound. Suppose, for example, there is a 45° phase shift between the 1KHz tone and its fourth harmonic, the 4KHz tone. This would, in effect, slow the 4KHz tone down by ¼ of a cycle, and force a different combination with the fundamental tone and the other harmonics. This would change the waveshape of this particular note, and consequently the sound you heard when the waveform hit your eardrum. In order to preserve as much as possible the original sounds of the instruments to which you are listening, the total phase distortion of your audio system should be as low as possible. For a given amplifier or preamplifier, it should be less than 15° across the audio bandwidth of 20Hz to 20KHz.

PHASE RESPONSE

Hi-Level: typically + 1° to -7°, 20Hz-20KHz with hi-impedance load.
or + 1° to -12°, 20Hz-20KHz with IHF load.

Phono: typically ± 5° additional phase shift 20Hz-20KHz.

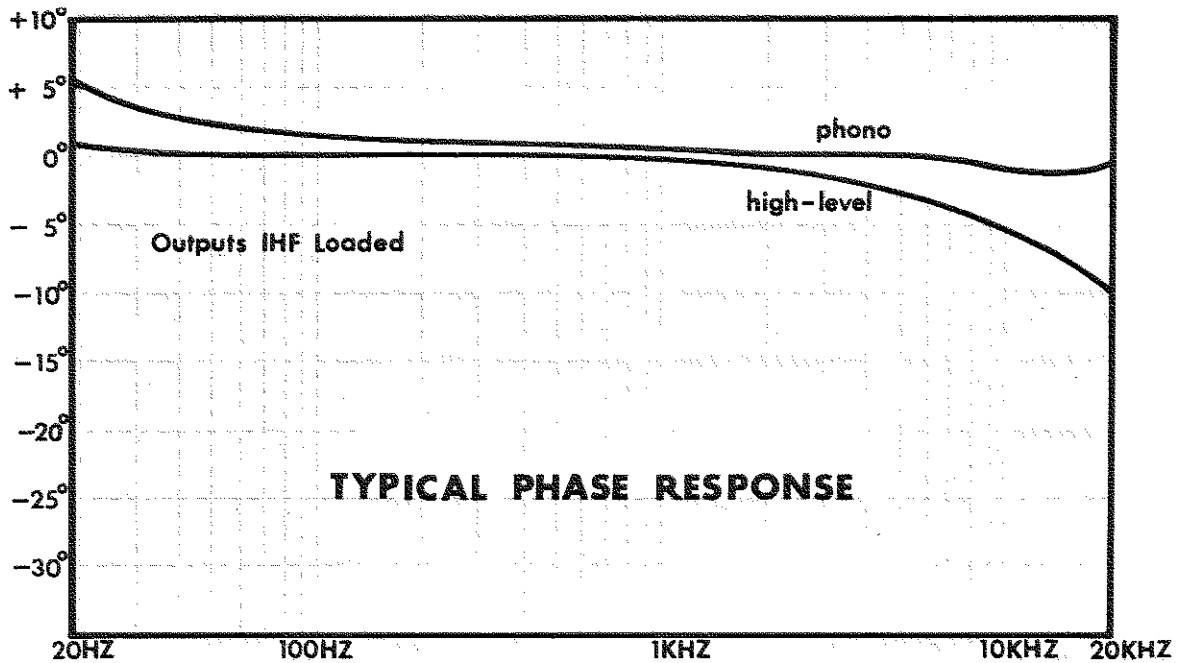

FIGURE 4-8. TYPICAL PHASE RESPONSE

4.9 DISTORTION

Harmonic distortion measurements have customarily been used to evaluate the performance of audio equipment. The preceding note concerning phase response made reference to the importance of harmonic tones in musical sound. Harmonic distortion figures show the degree to which a piece of audio equipment changes a signal by adding harmonics to it. (To make the test, a signal known to have a very low level of distortion is introduced at the input of the unit under test.) The resulting output (usually at the rated output level of the equipment) is then compared to the input to determine what percentage of harmonic tones has been added to the original signal. This test is repeated at several frequencies in the audio band (20Hz-20KHz), and the amount of harmonic distortion is graphed on a frequency scale.) The drawback to this type of test lies in the fact that such distortion can actually sound pleasant. In the same way that phase distortion can change a sound without making it unpleasant, harmonic distortion can change the harmonic makeup of a tone without offending your ears, since the additions to the original tone arrive in harmonic intervals. Intermodulation distortion is a different breed of cat. Instead of adding harmonious sounds to your music, it deals in sum-

and-difference frequencies. For instance, a 100Hz tone from a bass clarinet might modulate a 1000Hz tone from a violin to produce a 900Hz signal (the difference between the two frequencies), and an 1100Hz tone (the sum of the two signals). The resulting sound has all the endearing qualities of a piano smashing contest, and none of the benefits (i.e. piano smashing is good clean fun and it gets rid of some bad pianos). Besides showing up a more unpleasant type of distortion in audio equipment, IM distortion measurements relate more directly to crossover distortion, a problem especially troublesome in transistor amplifiers. On the whole, therefore, IM distortion measurements constitute a more valid means of evaluating audio equipment. In making the IM test, signals of 60Hz and 7000Hz are fed simultaneously to the input of the amplifier under test. Their interaction with each other is measured at the output of the amplifier, as the test is performed at different output levels. The IM test results are then graphed on a voltage or power scale: voltage output for preamps, and wattage output for power amps. Since harmonic distortion is given as a function of frequency, and intermodulation distortion as a function of output level, there is no direct comparison between the two. Usually, however, in audio equipment of good design, the IM readings are several times higher than the harmonic distortion readings.

Total Harmonic Distortion: essentially too low to measure.

Intermodulation Distortion: with IHF load less than 0.01% at 2.5 volts out.
(typically less than 0.002% at 2.5 volts)
(typically less than 0.004% at 10.0 volts)

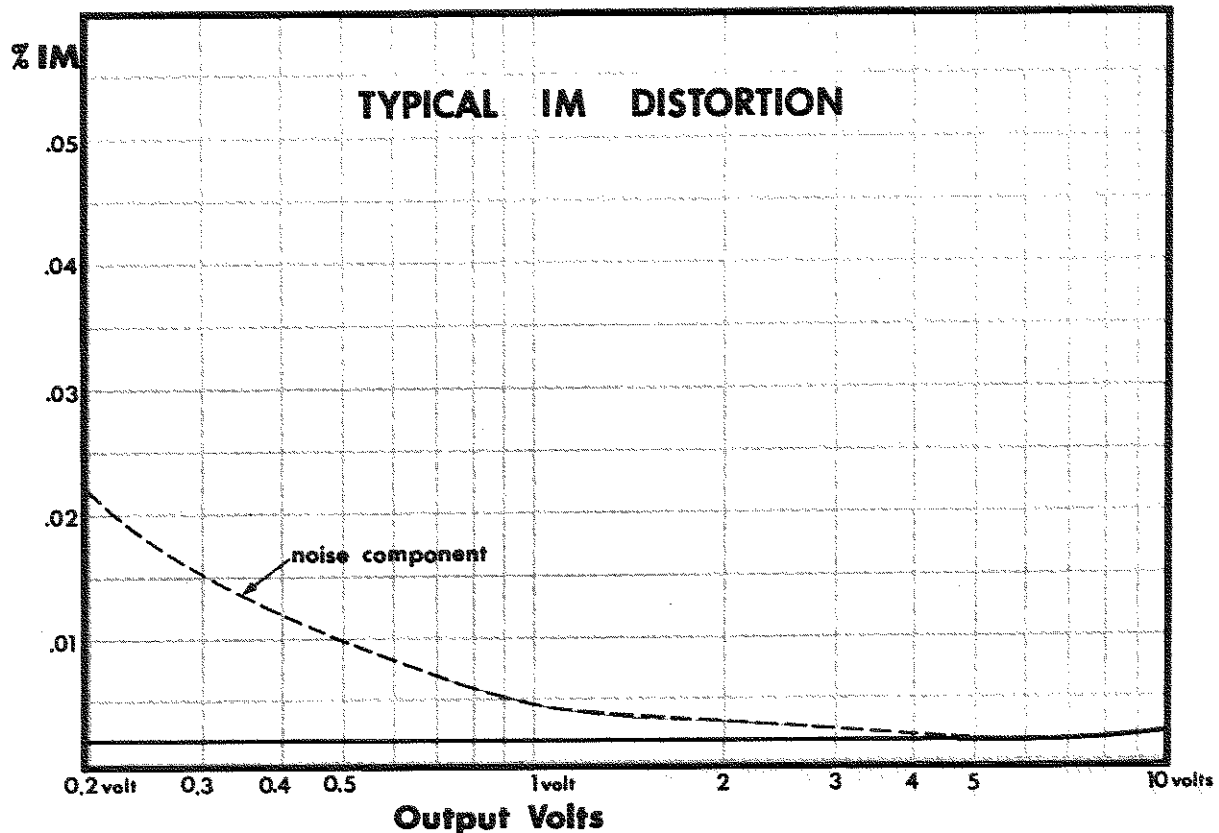

FIGURE 4-9. TYPICAL IM DISTORTION

4.10 HUM AND NOISE

Hum and noise designate an unwanted collection of spurious signals of different frequencies and amplitudes that lurk somewhere around the lowest output levels of your audio system. The chart below indicates the range between the noise levels and the operating levels of the IC-150. The dynamic range of audio equipment indicates the usable range of output — in other words, the range that lies between noise interference at low levels and distortion or overloading at high levels. The dynamic range of an audio production indicates the difference in volume between its softest and loudest parts. A dynamic range of 60db, for instance, means that the highest signal levels are 60db (1000 times) higher than the lowest signal levels. Noise becomes the limiting factor for most audio media. A very good tape or record may have a range of about 70db, while a tuner can carry programming with about a 60db range. Trying to expand the range further brings noise into the low levels of the programming. The human ear can safely appreciate a range of about 100db, but any dreams of approaching that range with listening material will remain dreams until the problems of noise and distortion have been further subdued. The relative level chart indicates where the average program range might fall in the

operation of an IC-150 preamp. At the levels shown, the softest sounds being played stay well above the noise level. By lowering the volume too far, however, with either the phono gain pots or the main volume control, the program can be turned down far enough to get into the noise region at the low end.

The problem of noise can be compounded by the unfortunate truth that power amplifiers will indiscriminately amplify noise along with everything else. If the final amplifier stage of your audio system adds 30db of gain to the signal, it also increases the noise in the signal by 30db, which may bring the noise up to an annoyingly audible level. To make the best of this situation, it is a good idea to keep your power amp below full gain, and provide as much of the level as possible with the preamp. The diagram below illustrates the point here. By increasing the preamp gain, we get more output signal without more output noise. This makes it practical to set the gain of the power amp at a lower level, and thus to amplify the noise much less. The result is the same signal level at the output, with a lower noise level. Care must be taken however, to keep the amplifier gain high enough to allow full output from the amplifier before the IC-150 overloads at 10V of output.

HUM AND NOISE

(20Hz-20KHz, inputs shorted)

Hi-Level inputs: 90db below rated output of 2.5 volts.

(typically 100db below rated output with IHF "A" weighted measurement)

Phono inputs: 80db below 10mv input (less than 1uv)

(typically 0.5uv)

COMPARISON OF NOISE AND PROGRAM LEVELS

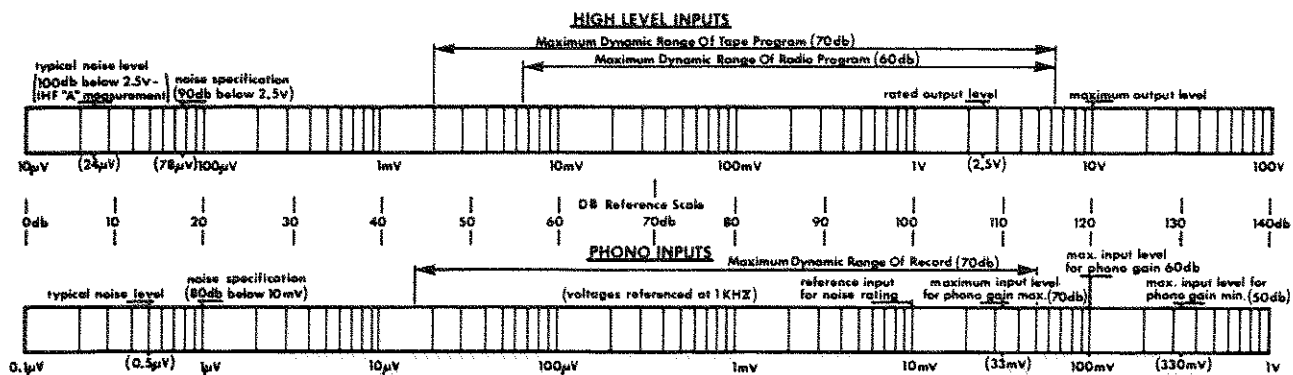
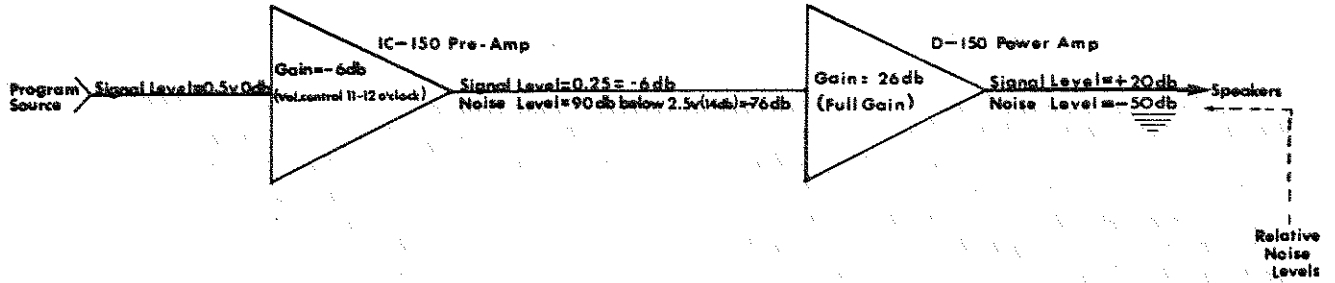

FIGURE 4-10. COMPARISON OF NOISE AND PROGRAM LEVELS

MAXIMUM NOISE SET-UP



MINIMUM NOISE SET-UP

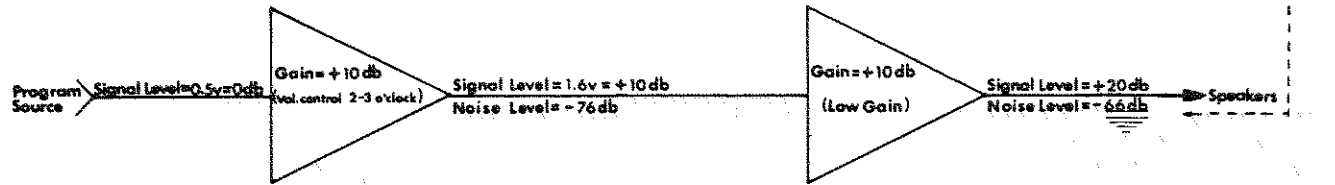
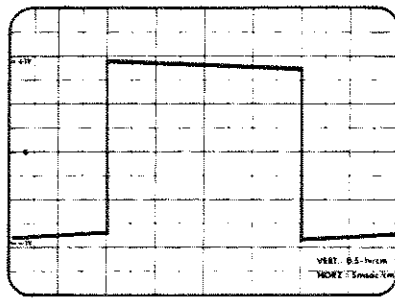
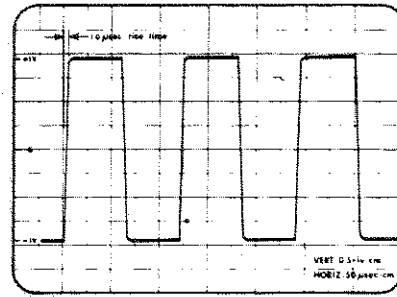

FIGURE 4-11. CONTROL SETTINGS FOR MINIMUM NOISE



30HZ SQUARE WAVE: HIGH LEVEL INPUT



10KHZ SQUARE WAVE: HIGH LEVEL INPUT

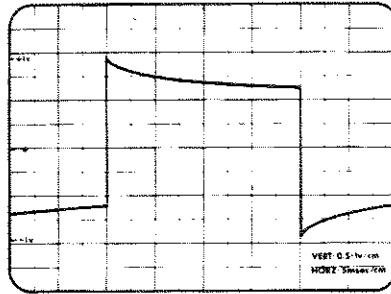

30HZ SQUARE WAVE: PHONO INPUT

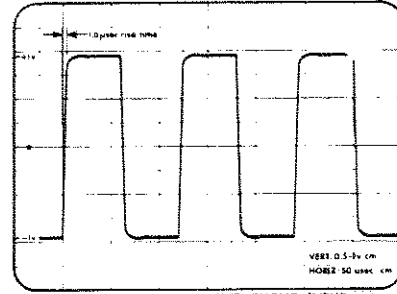

10KHZ SQUARE WAVE: PHONO INPUT

FIGURE 4-12. SQUARE WAVE RESPONSE

4.11 SQUARE WAVE RESPONSE

The square wave response of any audio equipment indicates the bandwidth of the equipment. High frequency square wave response shows the ability of the equipment to respond quickly to sudden changes in the signal (or to accurately reproduce high frequency signals). The low frequency square wave gives an indication of the degree to which the input coupling circuit (which blocks dc) affects low frequency signals. Square waves work particularly well for demonstrating circuit response speed, because in accurately reproducing the waveform the circuit must switch suddenly back and forth between different levels, while maintaining stability, which is a hard thing to do. The square wave makes a simple visual test because any distortion in this simple waveform is comparatively easy to see. The square wave response of the IC-150, as shown above for both low and high frequencies, demonstrates the capacity of this unit for clearly amplifying a wide range of frequencies. Another description of response speed is the slewing rate figure, which tells how quickly the preamp can change output levels. The rate of change is expressed as volts per microsecond, meaning that the output level can change so many volts in one millionth of a second. For the IC-150 the slewing rate typically measures 4.25 volts/microsecond.

4.12 CROSSTALK

Crosstalk designates any interference of one input with another. For instance, if you leave your tuner turned on while you switch to a phono input to listen to a record, it's super-annoying to hear the tuner output combining with your phono output. In the same way the inputs to the tape and auxiliary terminals are not supposed to combine their efforts, but are to remain separate so that the selector switch can indeed give you a real choice. Several conditions affect the problem of crosstalk. The output impedance of your source (such as a tuner or tape deck) is a factor, with a high impedance output making the problem worse. Frequency is also a factor. As frequency increases, crosstalk generally worsens, although standard procedure is to give crosstalk figures (when they

are given at all), only at 1KHz. Inside the preamp, wire dressage is a factor in keeping crosstalk low. Essentially, wires from inputs to switch terminals and then to the amplifying circuitry must be efficiently separated to prevent the signal on one wire from feeding into any other wire. The most conservative way to rate crosstalk is to check all combinations of inputs and pick the worst case as the rating. For the IC-150, the worst crosstalk at 1KHz (with a 50 ohm generator at 2.45V out and the undriven input terminated with a 5K "source" resistor) is Tape 2 feeding into Tape 1 with the selector on Tape 1. The difference in levels is better than 66db, which means that the unwanted signal is typically more than 2000 times smaller than the desired signal. The crosstalk between the other inputs is generally better, with the Phono inputs, for instance, showing crosstalk down by more than 95db between them at 1KHz. In general the readings are degraded directly by the magnitude of the "source" resistor. That is to say, for a more typical source impedance of 500 ohms the worst case crosstalk would be 86db, a tenfold improvement.

4.13 SEPARATION

Separation is the bedfellow of crosstalk, as it designates the degree to which either of the two stereo channels interferes with the other. Again, increasing frequency makes the problem worse. The same method of measurement is followed as was used to rate crosstalk (i.e. find the worst case and use it as the rating). Typically the worst separation in the IC-150 occurs with the left channel feeding into the right channel on the Tape 1 input. The separation is generally worse with the volume control low — with the worst case being about 55db separation at 1KHz (the unwanted signal more than 500 times smaller than the desired signal) when the volume is turned almost all the way down. With the volume control at maximum the separation is typically 65db (a difference in signal levels of better than 1500; this becomes 85db with a 500 ohm source impedance). The separation when other inputs are used is higher, with the Phono inputs, for instance, showing separation of 80db at 1KHz (a difference of 10,000 in signal levels).

SECTION 5

SERVICE PROCEDURES

5.1 INTRODUCTION

This section contains technical information required to properly service and repair the CROWN IC-150 Integrated Circuit Stereo Console. Included are disassembly and reassembly procedures, a troubleshooting chart (for isolating and identifying defective components), adjustments, test setups and procedures and component replacement procedures. Use this information in conjunction with Section 6, Schematics, Parts Lists and Component Location to obtain best results.

5.2 SERVICE POLICIES

Only a fully-trained, competent service technician should be allowed to service the IC-150 Integrated Circuit Stereo Console. User servicing should be confined to routine replacement of the fuse on the rear panel or replacement of damaged control knobs on the front panel.

For other service, it is recommended that the unit be returned to the factory in the original packing or replacement packing obtained from the CROWN factory or approved warranty stations.

Before returning a CROWN IC-150 to the factory for service, authorization should be obtained from the service manager. All shipments must be sent by UPS, Railway Express or Truck Freight, prepaid and insured at total value. The factory will return your serviced unit by UPS, Railway Express or Truck Freight.

5.3 WARRANTY

CROWN guarantees this equipment to perform as specified. CROWN also warrants the components and workmanship of this equipment to be free from defects for a period of 90 days from date of purchase.

This warranty does not extend to fuses, and/or component or equipment damage due to negligence, misuse, shipping damage or accident; or if the serial number has been defaced, altered or removed.

An application for a FREE 3-year WARRANTY TITLE is included with the instruction manual received with the equipment. Upon receipt of this completed form, CROWN will issue the Warranty Title — subject to the conditions contained therein. This title applies to the original end-purchaser and will be issued only upon receipt of the application.

5.4 DISASSEMBLY FOR SERVICING

The IC-150 Stereo Console is specifically designed for easy servicing. It may be partially disassembled and still be made operational for bench testing and servicing. This may be accomplished by removing the top and bottom covers (paragraph 5.4.1).

This provides easy access to all major components of the console. Detailed procedures are given in this paragraph for replacing individual subassemblies and critical components.

CAUTION!

DO NOT attempt component replacement or other repairs with power applied.

5.4.1 Removal of Top and Bottom Covers

Refer to Figure 6-12.

1. Remove ac power from IC-150.
2. Remove four screws ⑧, two from each end of the IC-150.
3. Remove six screws ⑦, three each from the front edges of the top and bottom covers.
4. Remove the top cover.
5. Remove two screws ⑥ from the rear of the bottom cover and remove the bottom cover.
6. Both sides of the main PC board, phono PC board and volume control PC board (where applicable) are now accessible for service.

Reverse the above sequence of actions to reassemble the IC-150.

5.4.2 Replacement of Selector Switch (SW1)

Refer to Figure 6-14.

1. Remove top and bottom covers from IC-150 (par. 5.4.1).
2. Unsolder and tag for identification, all wires connected to the wafer contacts of SW1.
3. Remove knob, hex nut ③ and washer ② from the shaft of SW1.
4. Remove defective switch SW1 and replace with new switch.
5. Install washer ② and hex nut ③ on shaft of new SW1.
6. Solder all wires removed in Step 2 to appropriate contacts on wafers of SW1. Remove identification tags.
7. Turn shaft of SW1 completely CCW and reinstall knob with the indicator showing PHONO 1.
8. Replace top and bottom covers on IC-150 (par. 5.4.1).

5.4.3 Replacement of Main PC Board Assembly

Refer to Figures 6-5, 6-6 or 6-7.

1. Remove top and bottom covers from IC-150 (par. 5.4.1).

2. Remove knobs, hex nuts and washers from VOLUME, BALANCE, PANORAMA, BASS and TREBLE controls.

CAUTION

In Step 3, be extremely careful to prevent unnecessary strain on wires connected to the main PC board and avoid flexing the board itself.

3. Carefully move main PC board assembly toward the rear of the IC-150 and rotate the control shaft edge of the board upwards until the foil side is accessible.
4. Unsolder all wires and external components attached to the board and tag for identification.
5. Remove defective main PC board assembly and replace.
6. Resolder all wires and external components removed in Step 4. Remove identification tags.
7. Carefully rotate the control shaft edge of the main PC board assembly down toward the IC-150 front panel and insert control shafts into appropriate mounting holes.
8. Replace washers, hex nuts and control knobs removed in Step 2.

NOTE

Perform BASS ADJUST (par. 5.7.8) and TREBLE ADJUST (par. 5.7.11) to correctly position knobs.

9. Replace top and bottom covers on IC-150 (par. 5.4.1).

5.4.4 Replacement of Phono PC Board Assembly

Refer to Figure 6-9 or 6-10.

1. Remove top cover from IC-150 (par. 5.4.1).
2. Use a 3/16" Allen wrench and remove two PHONO GAIN control nuts from the IC-150 rear panel.

CAUTION

In Step 3, be careful to prevent unnecessary strain on wires connected to the phono PC board and avoid flexing the board itself.

3. Carefully remove the phono PC board from the rear panel until the foil side of the board is accessible.
4. Unsolder all wires and external components attached to the board and tag for identification.
5. Remove defective phono PC board assembly and replace.
6. Resolder all wires and external components removed in Step 4. Remove identification tags.
7. Insert control shafts of PHONO GAIN controls into mounting holes in rear panel.
8. Replace PHONO GAIN control nuts removed in Step 2.

NOTE:

Perform PHONO GAIN adjustment (par. 5.7.15).

9. Replace top cover on IC-150 (par. 5.4.1).

5.4.5 Replacement of Volume Control (R24)

Refer to Figure 6-13.

1. Remove top and bottom covers from the IC-150 (par. 5.4.1).
2. Perform Steps 2 and 3, paragraph 5.4.3 to gain access to foil side of main PC board.
3. Carefully unsolder R24 mounting connections (10 places) and remove from the board.
4. Place new R24 in position and solder 10 connections to the main PC board.
5. Perform Steps 7 and 8, paragraph 5.4.3 to replace main PC board in normal position.
6. Replace top and bottom covers on the IC-150 (par. 5.4.1).

NOTE:

If unit is before SN IC-762, Step 2 above refers to volume control board only.

5.4.6 Replacement of Balance Control (R25)

Refer to Figure 6-13.

1. Remove top and bottom covers from the IC-150 (par. 5.4.1).
2. Perform Steps 2 and 3, paragraph 5.4.3 to gain access to foil side of main PC board.
3. Carefully unsolder R25 mounting connections (6 places) and remove from the board.
4. Place new R25 in position and solder 6 connections to the main PC board.
5. Perform Steps 7 and 8, paragraph 5.4.3 to replace main PC board in normal position.
6. Replace top and bottom covers on the IC-150 (par. 5.4.1).

5.4.7 Replacement of Bass Control (R39)

Refer to Figure 6-13.

1. Remove top and bottom covers from the IC-150 (par. 5.4.1).
2. Perform Steps 2 and 3, paragraph 5.4.3 to gain access to the foil side of main PC board.
3. Carefully unsolder R39 mounting connections (6 places) and remove from the board.
4. Place new R39 in position and solder 6 connections to the main PC board.
5. Perform Steps 7 and 8, paragraph 5.4.3 to replace main PC board in normal position.
6. Replace top and bottom covers on the IC-150 (par. 5.4.1).

5.4.8 Replacement of Treble Control (R33)

Refer to Figure 6-13.

1. Remove top and bottom covers from the IC-150 (par. 5.4.1).
2. Perform Steps 2 and 3, paragraph 5.4.3 to gain access to the foil side of main PC board.
3. Carefully unsolder R33 mounting connections (6 places) and remove from the board.
4. Place new R33 in position and solder 6 connections to the main PC board.
5. Perform Steps 7 and 8, paragraph 5.4.3 to replace main PC board in normal position.
6. Replace top and bottom covers on the IC-150 (par. 5.4.1).

5.4.9 Replacement of Panorama Control (R32)

Refer to Figure 6-13.

1. Remove top and bottom covers from the IC-150 (par. 5.4.1).
2. Perform Steps 2 and 3, paragraph 5.4.3 to gain access to the foil side of main PC board.
3. Carefully unsolder R32 mounting connections (4 places) on the main PC board and one black wire from R32 rearmost pot.
4. Remove jumper wires on old R32 and solder in comparable locations on new control.
5. Place new R32 in position and solder 4 connections to the main PC board and one black wire to R32 rearmost pot.
6. Perform Steps 7 and 8, paragraph 5.4.3 to replace main PC board in normal position.
7. Replace top and bottom covers on the IC-150 (par. 5.4.1).

5.4.10 Replacement of Push for Loudness Switch (SW4) and Push for Flat Switch (SW6, Tone Cancel)

Refer to Figure 6-5, 6-6 or 6-7.

1. Remove top and bottom covers from the IC-150 (par. 5.4.1).
2. Perform Steps 2 and 3, paragraph 5.4.3 to gain access to the foil side of the main PC board.
3. Carefully unsolder SW4 (or SW6) mounting connections (12 places) on the main PC board, and remove switch.
4. Place new SW4 (or SW6) in position and solder 12 connections on the main PC board.
5. Perform Steps 7 and 8, paragraph 5.4.3 to replace main PC board in normal position.
6. Replace top and bottom covers on the IC-150 (par. 5.4.1).

5.4.11 Replacement of Pushbutton Switch Assembly, 40817 (SW2, Tape 1; SW3, Tape 2; SW5, Lo Filter; SW7, Hi Filter; AC ON)

Refer to Figure 6-15.

1. Remove top and bottom covers from the IC-150 (par. 5.4.1).
2. Perform Steps 2 and 3, paragraph 5.4.3 to gain access to the pushbutton assembly mounting screws.
3. Remove two screws (3) and two brass spacers (2).

CAUTION

In Step 4, be careful to avoid unnecessary strain on wiring connected to pushbutton assembly.

4. Carefully pull the pushbutton assembly back from the front panel until all contacts and wiring are accessible.

NOTE

It is possible to change individual sections of the pushbutton assembly. Simply bend upwards the four metal tabs securing the switch sections and remove the defective section.

5. Carefully unsolder and tag for identification all wires connected to the contacts of the pushbutton assembly.
6. Replace the entire pushbutton assembly (or individual section) and resolder all wiring.
7. Carefully place pushbutton assembly in normal position and replace two brass spacers (2) and two screws (3).
8. Perform Steps 7 and 8, paragraph 5.4.3 to replace main PC board in normal position.
9. Replace top and bottom covers on the IC-150 (par. 5.4.1).

5.4.12 Replacement of Power Switch (SW8)

Refer to Figure 6-11.

1. Remove top and bottom covers from the IC-150 (par. 5.4.1).
2. Locate SW8 attached to bottom of main chassis and unsolder and tag for identification one lead of R55 (100 ohm) and two wires (one orange and one red) from the contacts of SW8.
3. Remove two hex nuts (18) securing SW8 to the main chassis and remove defective SW8.
4. Install new SW8 and replace two hex nuts (18). Be sure new SW8 is positioned so the plunger of AC ON pushbutton switch operates the arm of SW8.
5. Resolder the lead of R55 and the two wires removed in Step 2. Remove identification tags.
6. Replace top and bottom covers on the IC-150 (par. 5.4.1).

5.4.13 Replacement of Power Transformer (T1)

Refer to Figure 6-11.

1. Remove top and bottom covers from the IC-150 (par. 5.4.1).
2. Locate transformer T1 on main chassis and remove two screws ⑨, two hex nuts ⑪ and one washer ⑩.
3. Carefully lift T1 until terminals and connecting wiring is accessible.
4. Unsolder and tag for identification all wires connected to T1 terminals and remove defective T1.
5. Resolder wires removed in Step 4 to new T1 and remove identification tags.
6. Replace hardware removed in Step 2.
7. Replace top and bottom covers on the IC-150 (par. 5.4.1).

5.5 TEST EQUIPMENT

The IC-150 Stereo Console is a relatively complex unit and requires a comprehensive array of test equipment for complete

servicing. A recommended list of test equipment is shown in Table 5-1.

In the absence of a complete set of test equipment, it should be noted that most troubleshooting can be successfully done with an oscilloscope, an ohmmeter, a voltmeter and a signal generator. Any malfunctions which cannot be identified and repaired with this basic equipment should be referred to the CROWN factory or authorized service center.

5.5.1 Calibration of Test Equipment

It is important that test measurements made during servicing be accurate and dependable. Otherwise the performance of the IC-150 cannot be properly evaluated. Test equipment shown in Table 5-1 should remain properly calibrated with only periodic checks (6-month intervals). If less expensive (and thereby less dependable) test equipment is used, frequent calibration is necessary to assure the accuracy required for proper servicing.

Equipment	Requirements	Application	Suggested Model
Oscilloscope	Capable of displaying a 10 Megahertz signal	Monitoring output during service and testing	Telequipment SS4A or equivalent
Voltohmmeter (VOM)	Low-voltage resistance probe (100 mv range). High-voltage resistance probe (1.5 v range).	Check resistance values (low voltage probe). Check semiconductor junctions for opens or shorts (High-voltage probe). Check DC voltages.	Triplet 601 or equivalent
Signal Generator	Sine/square wave available; flat frequency response.	Provide test signals for service and checkout.	Wavetek 130-Series or equivalent.
AC Line Monitor	Peak reading meter.	Monitor line voltage during testing.	Information available from CROWN.
Variac		Keep line voltage at 120 VAC during tests.	Superior Powerstat 116B or equivalent
AC Voltmeter	100 mv low range	Check noise level.	Hewlett Packard 400F or equivalent.
Filter	20-20KHz bandpass, low noise.	Between IC-150 and voltmeter in noise test.	Information available from CROWN.
Intermodulation Distortion Analyzer		Check IM distortion.	Information available from CROWN.

TABLE 5-1, LIST OF TEST EQUIPMENT

5.6 TEST PROCEDURES

This paragraph lists precautions essential to obtain accurate test measurements when servicing high-purity control equipment such as the IC-150.

1. Use the proper line voltage (120 VAC or 240 VAC) for which the power supply has been wired for normal operation. Line voltage should be measured with a peak reading ac voltmeter and adjusted to the rms equivalent voltage (to compensate for line voltage regulation errors during the course of the test measurements).
2. All output voltages should be measured with **no load** using a high impedance (greater than 100K) voltmeter.
3. The VOLUME control should be set to maximum for all distortion tests to assure repeatability of all test measurements.
4. All inputs should be disconnected from the IC-150 when measuring hum and noise and the VOLUME control set to minimum.
5. Whenever possible avoid ground loops in the test equipment caused by connecting the output ground to the input ground. Ground loops are especially obnoxious when measuring distortion. An IM distortion analyzer, for example, has its inputs and output terminals tied with a common ground. Such a test should use an ungrounded output return, with the output lead(s) wrapped around the well-shielded and grounded input cable.
6. Always monitor the test oscillator when measuring frequency response. Use a wideband ac voltmeter or use the same meter for both input and output level measurements, if the meter's frequency response is known not to be dependent on attenuator settings.
7. Residual distortion and noise levels should be fully known for all test equipment in order to accurately evaluate the performance of the IC-150.
8. Never measure hum and noise when in the presence of strong magnetic fields. The IC-150 should be at least 4 inches from any large metallic objects or shield plates for a reading to be meaningful.
9. Noise measurement should be taken with the output band-pass filtered for 20Hz-20KHz. For audio purposes the measurement of noise above 20KHz is meaningless.
10. Ohmmeter tests can usually be performed on semiconductors with the 1.5-volt probe. On the RX1 scale, the normal forward breakdown resistance for semiconductors will usually fall in the 5-15 ohms range.

To check resistor values without removing them from the circuit and without forward biasing any junctions, the low voltage probe (100 mv range) should be used.

The effect of parallel resistance paths must be considered in determining whether a test reading is normal. The simplest procedure is a comparison with the same reading under identical conditions on a properly functioning channel. If both channels are defective, compare the reading with those on a good unit.

Approximate resistance measurements for transistors (outside a circuit) appear below. Large resistance means little or no indication on the RX1 ohm scale. Base-emitter and base-collector readings in a transistor should match within several ohms. The first lead in the list below takes the positive meter probe for an NPN transistor; the negative meter probe for a PNP transistor.

Base-emitter	5-15 ohms
Emitter-base	Large
Base-collector	5-15 ohms
Collector-base	Large
Collector-emitter	Large
Emitter-collector	Large

Diodes should show approximately 5-15 ohms forward resistance and large reverse resistance.

Know your ohmmeter — all types do not operate the same. Some have the positive lead common, others the negative. You must be aware of this when measuring forward or reverse junction resistances. Some meters use a nine-volt test voltage on high resistance scales which can forward bias enough junctions in a solid state circuit to cause avalanche confusion. Know the test voltage for the scale used.

5.7 TROUBLESHOOTING

The information contained in the troubleshooting chart has been compiled from data gathered from field service reports and factory experience. It contains symptoms and usual causes for the service problems described; however, do **not** assume that these are the only problems that may occur. All available data concerning the reported trouble should be systematically analyzed before undertaking any drastic repairs or component replacement procedures. The following general procedure should be used in servicing the IC-150.

a. Verify and Identify the Problem

Assemble and analyze all data accompanying the IC-150. Do **not** automatically assume that the unit is, in fact, defective. Problems arising from the system configuration in which the unit is being used may be blamed on the IC-150. Refer to Table 5-3 for a list of common system problems and their associated symptoms. The alleged problem may be nothing more than faulty system connections or erroneous switch positions. Most written complaints are sketchy, sometimes ambiguous, and generally tend to oversimplify problems. Some problems may be painfully obvious — blown fuses, broken parts, or the smell of burned components. Should the problem not be simple to find, it may be helpful to contact the user directly and ask the following questions:

- (1) What are the details of the system in which the unit was being used? Has the system been carefully checked for possible problems outside the IC-150?
- (2) Describe the problem. Symptoms? One channel affected or both? Which channel?
- (3) Did the problem occur more than once? Were circumstances identical for all occurrences?

(4) What kind of input signal and load were used?

If the user is not available and the problem is not obvious, perform the regular factory checkout procedure. The troubleshooting chart is organized according to the sequence of the factory checkout procedure (Figure 5-1) and common service problems appear in the order they are most likely to occur. Table 5-2 lists tests, input signals and control settings. When a space for control settings is blank, that control remains in the position listed for the previous test.

b. Visual Inspection

A detailed visual inspection is worth performing for almost all problems and may avoid unnecessary additional damage to the IC-150.

- (1) Check for loose wires and wires that may be crimped or squeezed against components or the chassis in assembly. Suspicious wires may be pulled gently to assure they are securely fastened.
- (2) Check for loosened screws holding wiring connections.
- (3) Check for bad solder connections. Loose transistor leads may cause oscillation or noise.
- (4) Check for parts damaged by heat. Usually apparent by discoloration or burned odor.

5.7.1 Turn-on Procedure

Check the IC-150 for either 120 VAC or 240 VAC operation and plug in the power cord to an appropriate ac receptacle. Depress ON AC pushbutton to apply ac power.

SYMPTOM	PROBABLE CAUSE AND REMEDY
AC fuse blows	Wrong size fuse. Replace.
	Wrong ac line voltage. Check.
	Remove top cover from IC-150 (par. 5.4.1) and check for:
	Pinched wires in power supply circuitry
	Short in transformer primary.
No AC power; fuse OK	Shorted D6, D7, D8 or D9 in rectifier circuit.
	Short in ON AC switch (SW8).
	Open ON AC switch (SW8). Check switched and unswitched outlets. Open in transformer T1 circuit.

5.7.2 Power Supply Test, +18VDC and -18VDC

Before performing the tests in the regular factory checkout procedure, check the +18VDC and -18VDC voltages.

- 1. Remove the top cover from the IC-150 (paragraph 5.4.1).
- 2. Apply ac power to the IC-150 and set front panel controls as shown in Table 5-2 (Power Supplies).
- 3. Measure for +18VDC at the emitter of Q8 on the main PC board. If necessary, adjust potentiometer R53 (Fig. 6-5, 6-6 or 6-7) to obtain +18VDC.
- 4. Measure for -18VDC at the emitter of Q9 on the main PC board. If necessary, adjust potentiometer R28 (Fig. 6-5, 6-6 or 6-7) to obtain -18VDC.
- 5. If unable to obtain proper voltage, see below:

SYMPTOM	PROBABLE CAUSE AND REMEDY
+ or -18VDC cannot be properly adjusted	Defective transistor (Q8 for +, Q9 for -).
	Defective adjust potentiometer (R53 for +, R28 for -).
	Defective zener diode (D5 for +, D2 for -).
+ or -18VDC is + or -25VDC	Shorted transistor (Q8 for +, Q9 for -).

5.7.3 Tracking Test

- 1. Connect the IC-150 to test equipment .
- 2. Set the IC-150 front panel controls as shown in Table 5-2 (Tracking Test).
- 3. Record the maximum negative and maximum positive tracking errors obtained at any setting of the VOLUME control, turning it either direction in the test range. Figure 5-2
- 4. If any tracking errors exceed 3 dB, adjust R4 and/or R6 (tracking trimmers) on the main PC board to minimize the error.
- 5. If unable to bring tracking error within tolerance with R4 or R6, see below:

SYMPTOM	PROBABLE CAUSE AND REMEDY
Tracking error in excess of 3 dB	Defective VOLUME control (R24)

IC-150 INSPECTION REPORT

Serial No. _____
Technician _____

I. Tracking to 40 db _____ db Pan _____
Turning up
& down 50 db _____ db Bal _____
60 db _____ db

II. Loudness _____ Lo Filter _____ Bass Adj _____

III. Response & Stability: Flat _____ Adjustment _____
(10KHz J-L Wave)

IV. Slew _____ Treble Adj _____ Hi Filter _____

V. Treble Range ± 15 db 15KHz Left _____ Right _____

VI. Bass Range ± 15 db 30KHz Left _____ Right _____

VII. Phono gain 50-70db (set at 60) Left _____ Right _____

VIII. Phono Response: $\pm .5$ db (1KHz ref) Left _____ Right _____

IX. IM Distortion (%)	60Hz, 7KHz	Left 0.0 _____ 10v	Right 0.0 _____ 10v
	4:1	Left 0.0 _____ 5.62v	Right 0.0 _____ 5.62v
	SMPT E	Left 0.0 _____ 3.16v	Right 0.0 _____ 3.16v
		Left 0.0 _____ 1.78v	Right 0.0 _____ 1.78v
		Left 0.0 _____ 1v	Right 0.0 _____ 1v
		Left 0.0 _____ 562mv	Right 0.0 _____ 562mv
		Left 0.0 _____ 316mv	Right 0.0 _____ 316mv

X. Hi Level Noise: Vol _____ db _____ db
(Level below cw or ccw)
2.5 v 20-20KHz) wc _____ db _____ db

XI. Phono Noise: 0. _____ μ V 0. _____ μ V

Listen to all controls _____

Muter Turn-on _____

FIGURE 5-1. IC-150 INSPECTION REPORT

TEST	INPUT SIGNAL	SEL	LOUD	VOL	BAL	CONTROLS					
						PAN	PUSH FLAT	BASS	TREB	LOW FILT	HIGH FILT
Power Supplies	None	Tun	Out	Min	Nor	Nor	In	Flat	Flat	Out	Out
Tracking Test	1 KHz			Var							
40 dB	Sinewave										
50 dB	223 mv										
60 dB	-10.8 dB										
Panorama				Max		Var					
Balance					Var	Nor					
Loudness	100 Hz Square Wave 1.5V p-p		In	Mid	Nor						
Low Filter			Out							In	
Bass Adjust							Out	Flat		Out	
Response and Stability	10 KHz Square Wave 1.5V p-p						In (Out)		(Min) (Max)		
Slew				Max			Out			Max	
Treble Adjust	1 KHz Square Wave 1.5V p-p			Mid						Flat	
High Filter							In				In
Treble Range	15 KHz Sinewave 223 mv						In (Out)		Flat (Min) (Max)		Out
Bass Range	30 Hz Sinewave 223 mv						In (Out)	Flat (Min) (Max)			
Phono Gain	1 KHz Sinewave 2.45 mv -50 dB	Pho		Max			In	Flat	Flat		
Phono Response	20 Hz to 20KHz thru Inverse RIAA pad										
Intermodulation	60 Hz, 7 KHz 4:1 SMPTE	Tun									
High Level Noise	Short	Tun		Min or Max (Mid)							
Phono Noise	Short	Pho		Max							
Listen to Controls											
Muter Turn-on											

TABLE 5-2. IC-150 TESTS: CONTROL SETTINGS AND INPUT SIGNALS

TRACKING TEST EXAMPLE. At various settings of the volume control these outputs were observed.

LEFT	RIGHT	TRACKING ERROR
+ 10 dB	+ 10 dB	0 dB
+ 6	+ 7	- 1
+ 1	+ 1.2	- 0.2
- 1.8	0	- 1.8
- 6.5	- 5	- 1.5
- 10.2	- 10	- .2
- 11	- 11.5	+ .5
- 11.5	- 12.5	+ 1
- 15	- 15	0
- 19	- 19	0
- 24	- 23	- 1
- 27	- 25	- 2
- 30.5	- 30	- .5
- 35	- 34	- 1
- 40	- 40	0
- 45	- 47.5	+ 2.5
- 49	- 50	+ 1

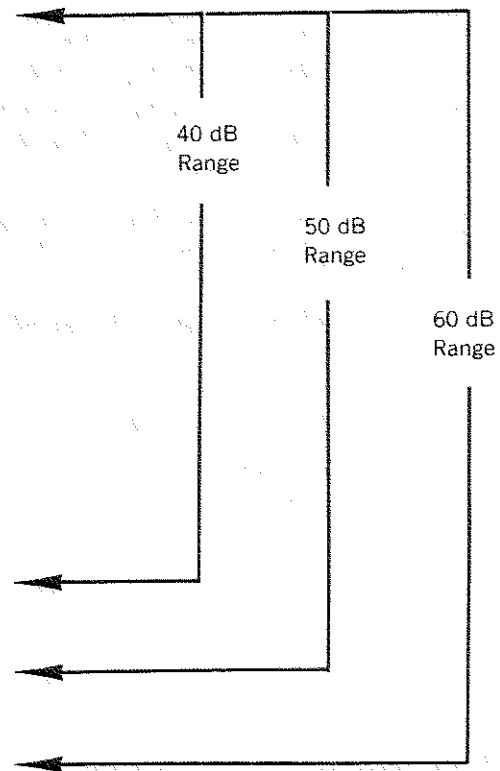

Record the maximum errors on the inspection report as below:

TRACKING TO: 40 dB -2 +1 dB
 50 dB -2 +1 dB
 60 dB -2 +2.5 dB

FIGURE 5-2. TYPICAL TRACKING TEST READINGS

5.7.4 Panorama Test

1. Set the IC-150 front panel controls as shown in Table 5-2 (PANORAMA).
2. Insert at TUNER input for RIGHT channel; 1 KHz sine wave at 1.5V peak-to-peak.
3. With PANORAMA control set at NORMAL, check that the full signal output appears at the RIGHT channel main output.
4. Rotate the PANORAMA control slowly to MONO and check that the signal output is now divided between RIGHT and LEFT channels.
5. Rotate the PANORAMA control slowly to REVERSE and check that the full signal output appears at the LEFT channel main output.
6. Move input signal shown in 2. above to the TUNER input for the LEFT channel.
7. With PANORAMA control set at NORMAL, check that the full signal output appears at the LEFT channel main output.
8. Rotate the PANORAMA control slowly to MONO and check that the signal output is now divided between RIGHT and LEFT channels.
9. Rotate the PANORAMA control slowly to REVERSE and check that the full signal output appears at the RIGHT channel main output.

SYMPTOM	PROBABLE CAUSE AND REMEDY
Mono output regardless of PANORAMA setting	C2 lead shorted to output terminal of other channel. Reposition lead or replace C2.
Other abnormalities	Replace PANORAMA CONTROL (R32).

5.7.5 Balance Test

1. Set the IC-150 front panel controls as shown in Table 5-2 (BALANCE).
2. Insert at TUNER inputs for both channels; 1 KHz sine wave.
3. With the BALANCE control set at NORMAL, check that the signal output is equal for both channels.
4. Rotate the BALANCE control slowly to the LEFT position and check that the right channel is gradually attenuated and finally turned off completely.
5. Rotate the BALANCE control slowly to the RIGHT position and check that the left channel is gradually attenuated and finally turned off completely.

5.7.6 Loudness Test

1. Set the IC-150 front panel controls as shown in Table 5-2 (LOUDNESS).
2. Insert at TUNER input; 100 Hz square wave at 1.5V peak-to-peak.
3. Observe typical output square wave (Figure 5-3) on oscilloscope.

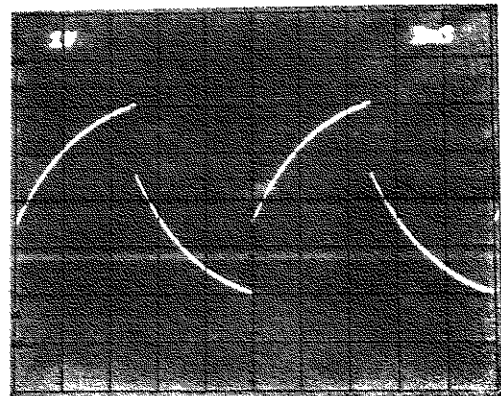

FIGURE 5-3. TYPICAL LOUDNESS TEST OUTPUT

5.7.7 Low Filter Test

1. Set the IC-150 front panel controls as shown in Table 5-2 (LOW FILTER).
2. Insert at TUNER input; 100 Hz square wave at 1.5V peak-to-peak.
3. Observe typical output square wave (Figure 5-4) on oscilloscope.

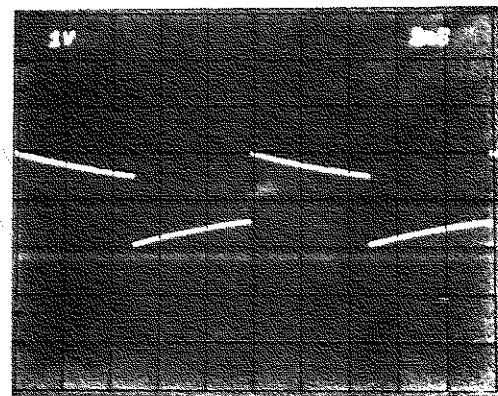

FIGURE 5-4. TYPICAL LOW FILTER OUTPUT

5.7.8 Bass Adjust Test

1. Set the IC-150 front panel controls as shown in Table 5-2 (BASS ADJUST).
2. Insert at TUNER input; 100 Hz square wave at 1.5V peak-to-peak.
3. Rotate BASS control to obtain best square wave output on oscilloscope.
4. Loosen BASS control knob and reposition on control shaft to indicate FLAT for best square wave output.

5.7.9 Response and Stability Test

1. Set the IC-150 front panel controls as shown in Table 5-2 (RESPONSE AND STABILITY).
2. Insert at TUNER input; 10 KHz square wave at 1.5V peak-to-peak.
3. Check that no oscillations or instabilities are visible on the output waveform shown in Figure 5-5.
4. Set PUSH FLAT control to OUT and TREBLE control to CUT (minimum). No oscillations or instabilities should occur.
5. Set TREBLE control to BOOST (maximum). No oscillations or instabilities should occur.

SYMPTOM	PROBABLE CAUSE AND REMEDY
Spurious oscillation with TREBLE control set at CUT (minimum).	Defective IC1. Replace.

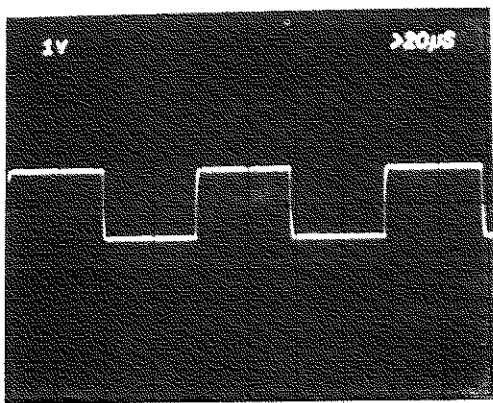

FIGURE 5-5. TYPICAL 10KHz SQUARE WAVE OUTPUT.

5.7.10 Slew Test

1. Set the IC-150 front panel controls as shown in Table 5-2 (SLEW).
2. Insert at TUNER input; 10 KHz square wave at 1.5V peak-to-peak.
3. Turn the VOLUME control through its entire range and check that no oscillations or instabilities are visible on the output waveform.

5.7.11 Treble Adjust Test

1. Set the IC-150 front panel controls as shown in Table 5-2 (TREBLE ADJUST).
2. Insert at TUNER input; 1 KHz square wave at 1.5V peak-to-peak.
3. Rotate TREBLE control to obtain best square wave output on oscilloscope.
4. Loosen TREBLE control knob and reposition on control shaft to indicate FLAT for best square wave output.

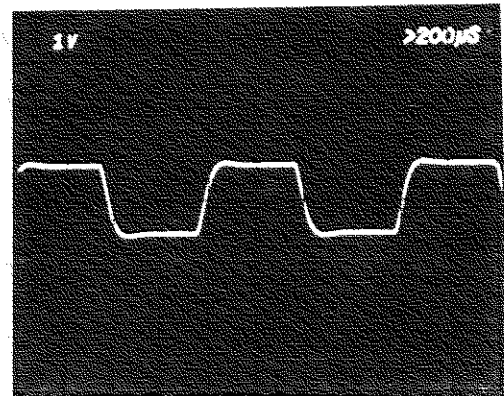

FIGURE 5-6. TYPICAL HIGH FILTER SQUARE WAVE OUTPUT

5.7.12 High Filter Test

1. Set the IC-150 front panel controls as shown in Table 5-2 (HIGH FILTER).
2. Insert at TUNER input; 1 KHz square wave at 1.5V peak-to-peak.
3. Check that the square wave output is as shown in Figure 5-6.

SYMPTOM	PROBABLE CAUSE AND REMEDY
Low level buzz in right channel.	Tune L201 to null out buzz. If unable to adjust, replace L201.

5.7.13 Treble Range Test

1. Set the IC-150 front panel controls as shown in Table 5-2 (TREBLE RANGE).
2. Insert at TUNER input; 15 KHz sinewave at 223 mv.
3. Adjust VOLUME control for 0 dB output.
4. Set PUSH FOR FLAT to OUT and rotate TREBLE control to CUT (minimum). Output must be attenuated to at least -15 dB.
5. Rotate TREBLE control to BOOST (maximum). Output must be increased to at least +15 dB.
6. Perform steps 4 and 5 for both inner and outer TREBLE control knobs.

5.7.14 Bass Range Test

1. Set the IC-150 front panel controls as shown in Table 5-2 (BASS RANGE).
2. Insert at TUNER input; 30 Hz sinewave at 223 mv.
3. Adjust VOLUME control for 0 dB output.
4. Set PUSH FOR FLAT to OUT and rotate BASS control to CUT (minimum). Output must be attenuated to at least -15 dB.
5. Rotate BASS control to BOOST (maximum). Output must be increased to at least +15 dB.
6. Perform steps 4 and 5 for both inner and outer BASS control knobs.

5.7.15 Phono Gain Test

1. Set the IC-150 front panel controls as shown in Table 5-2 (PHONO GAIN).
2. Insert at PHONO input; 1 KHz sinewave at 2.45 mv (-50 dB).
3. Rotate PHONO GAIN screwdriver adjust control on rear panel of IC-150 to full ccw position (minimum). Output must be less than 775 mv (0 dB).
4. Rotate PHONO GAIN control to full cw position (maximum). Output must be more than 7.5V (+20 dB).
5. Readjust PHONO GAIN control for a 2.45V (+10 dB) output (60 dB gain).
6. If unable to obtain conditions described in Steps 3 and 4, check bias voltage at Q2 emitter on the Phono Amplifier PC Board. Bias voltage should be +.5V to +5V.

SYMPTOM	PROBABLE CAUSE AND REMEDY
Bias -11V to -18V	Defective Q2; replace. C16 shorted; replace. R23 open; replace.
Bias +15V	Defective Q2; replace. R15 open; replace.
Unity (0 dB) gain	C16 open; replace.

5.7.16 Phono Response Test

1. Set the IC-150 front panel controls as shown in Table 5-2 (PHONO RESPONSE).
2. Insert at PHONO input through inverse RIAA pad; 20 Hz to 20 KHz.
3. Check that response is ± 0.5 dB, with reference to 1000 Hz.

SYMPTOM	PROBABLE CAUSE AND REMEDY
Response at 20 Hz up 1 dB	R15 value increased; replace.

5.7.17 Intermodulation (IM) Distortion Test

1. Set the IC-150 front panel controls as shown in Table 5-2 (IM DISTORTION).
2. Use the IM distortion test equipment shown in Figure 5-7.
3. Calibrate the IMA and set up the IM input signal at 60-7 KHz, 4:1 ratio as described in the IMA Manual. Insert this signal in the TUNER input on the IC-150.
4. Measure IM distortion on an average responding voltmeter. The IMA test signal, the peak equivalent of 10V RMS, should read 8.1V. IM distortion must not exceed 0.02%.

SYMPTOM	PROBABLE CAUSE AND REMEDY
High IM distortion	Defective IC1; replace.
High IM distortion at 10V output; normal at 5.62V output.	+18V or -18V supply voltage low. Refer to Paragraph 5.7.2.

5.7.18 High Level Noise Test

1. Set the IC-150 front panel controls as shown in Table 5-2 (HIGH LEVEL NOISE).
2. Insert 20-20KHz filter between IC-150 output and the input to the voltmeter.
3. Insert shorting plug in TUNER input.
4. With the VOLUME control set to either "minimum" or "maximum" the output must be greater than 92 dB below the 2.5V output.
5. Set the VOLUME control to mid-range. Output must be greater than 87 dB below the 2.5V output.

SYMPTOM	PROBABLE CAUSE AND REMEDY
High noise level	Defective IC1; replace.

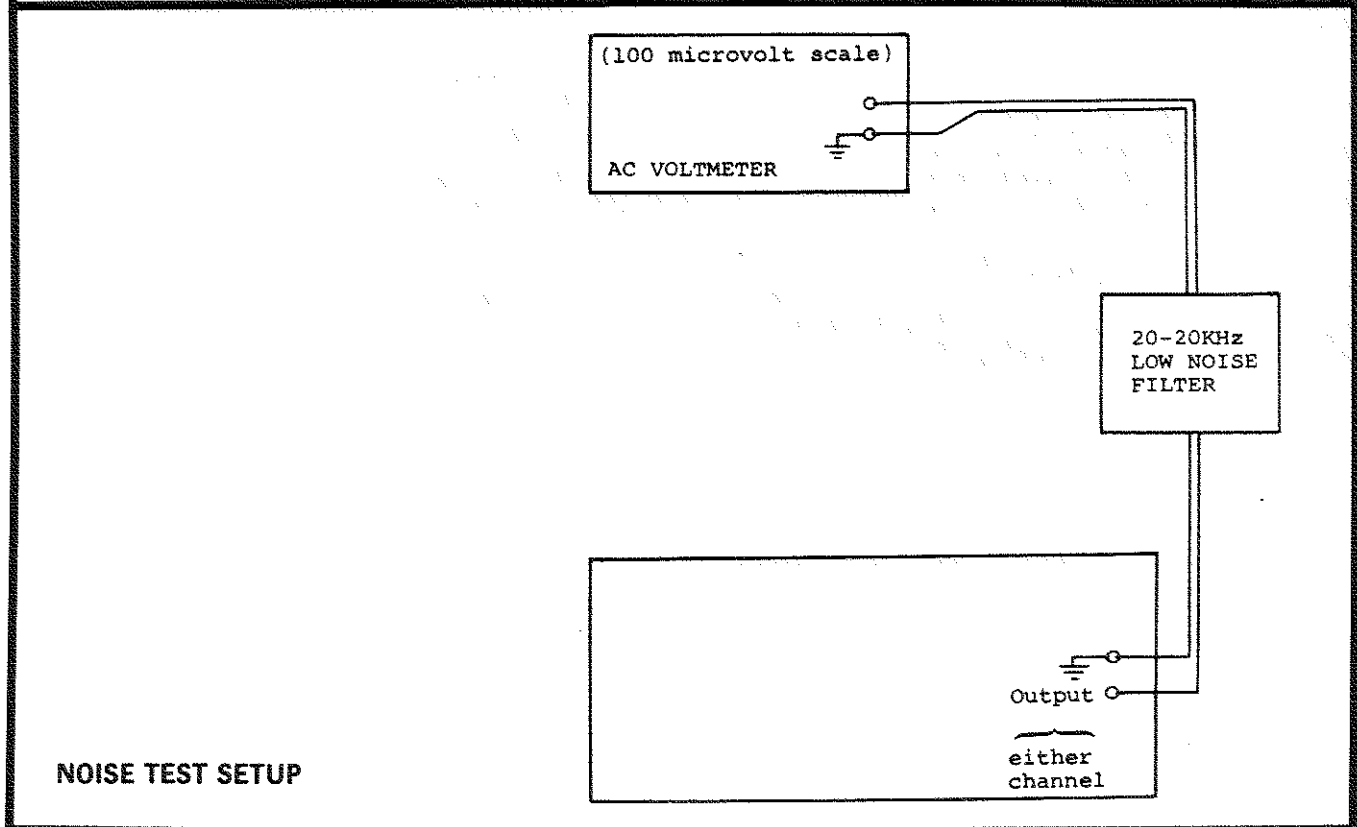
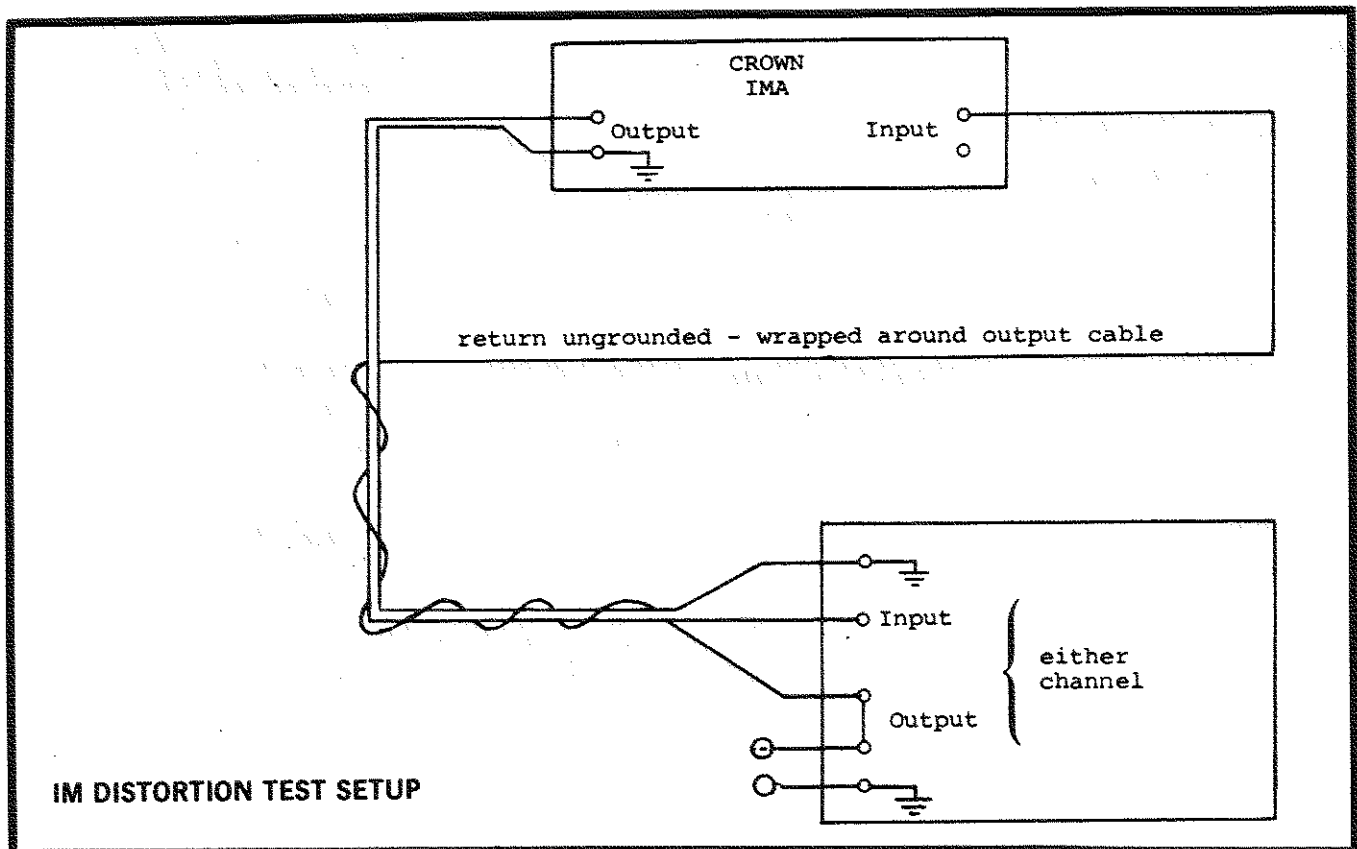

FIGURE 5-7. TEST EQUIPMENT SETUP

5.7.19 Phono Noise Test

1. Set the IC-150 front panel controls as shown in Table 5-2 (PHONO NOISE).
2. Insert shorting plug in PHONO input.
3. Check that output is less than 1 millivolt. With PHONO GAIN control on rear panel set at 60 dB this indicates 1 microvolt input noise. See Note below:

SYMPTOM	PROBABLE CAUSE AND REMEDY
High noise level; pre-dominantly hum:	
a. One or both channels	Redress input leads to PHONO AMPLIFIER PC BOARD.
b. Both channels	Defective Q5; replace Defective C17; replace Defective D1; replace
High noise level; pre-dominantly random	Defective Q1; replace Defective Q4; replace

NOTE:

Overall phono gain at 1000 Hz with VOLUME control maximum is variable between 50 dB and 70 dB with the rear panel controls. Phono gain is set at 60 dB at the factory. If you set the phono gain to another value, take this into consideration when measuring phono noise.

5.7.20 Controls Test

Operate all controls, listening carefully for scratches, clicks or pops. Clean control or switch contacts; if this does not remedy the condition, replace the control.

5.7.21 Muter Turn-on Test

When ac power is initially applied to the IC-150, the output should be shorted (muted) for 3 to 7 seconds.

SYMPTOM	PROBABLE CAUSE AND REMEDY
Output muted continuously	Mute jumper loose. Defective Q6; replace D3 shorted; replace Relay K1 defective; replace C34 open; replace

5.7.22 Miscellaneous Problems

The following trouble symptoms and possible causes and remedies may occur with the IC-150.

SYMPTOM	PROBABLE CAUSE AND REMEDY
Reed relay chatters (SN2354 and higher) and:	AC line voltage below 105V.
a. 60 Hz ripple present at D4 anode.	D7 or D8 open. Replace. Broken wire, T1 to D7 or D8. Repair.
b. 120 Hz ripple present at D4 anode.	Defective C31 or C34. Replace. Broken solder joint. Repair.
Intermittent buzz, especially in first few minutes after initial turn-on.	Defective Q8. Replace.
Large, high-frequency signal turns channel off (latch up).	Defective IC1. Replace.
Output clean at very low levels (60 to 200 mv) but clipped if driven to normal level. Usually intermittent.	Relay K1 installed backward.

PROBLEM	POSSIBLE CAUSES OR CURES
High noise or hum	<p>Power amp turned wide open — adjust amp according to the owner's manual</p> <p>Poor connection in associated wiring.</p> <p>Ground loop between IC-150 and associated equipment.</p> <p>Open ended input (i.e. shorting plugs removed without having put any input from tuner, phono, etc.)</p>
High noise or hum in phono	<p>Above suggestions apply.</p> <p>Gain pots on phono board have been turned up.</p> <p>Turntable not grounded to ground lug of IC-150.</p> <p>Turntable not properly wired causing clicks, hum, noise, etc.</p> <p>High local RF radiation from TV or radio stations — keep leads short, well dressed.</p>
Scratchy volume or other controls; also pops in switches	<p>Output caps in tuner, tape deck, etc., leaky causing D.C. to appear on volume control, LO filter, loudness button, and Bal & Pan controls. This will also cause pops in the selector switch.</p>
One channel dead	<p>Balance control not set to normal.</p> <p>Broken or shorted cables either coming into or out of IC-150 (try reversing the leads).</p> <p>One or more switches not properly released or depressed. (Try depressing and releasing all switches.)</p>
Both channels inoperative	<p>Suggestions for "one channel dead" apply.</p> <p>Muter terminals not tightened down.</p> <p>No wire in muter terminals.</p> <p>External (remote) muter switch not turning on — e.g.: turntable muter inoperative may make it impossible to get any signal through the IC-150.</p> <p>One or both tape monitor switches engaged.</p> <p>Fuse blown.</p> <p>IC-150 or associated equipment not plugged in, turned on, or turned up.</p> <p>Shorting plugs in outputs either "main" or "tape".</p> <p>No input signal or shorting plugs in the input.</p>
Distortion at high listening levels	<p>Possible vibration from speakers being picked up by phono tone arm and amplified by the IC-150.</p>
High Frequency Oscillation (Power amplifier mysteriously heats)	<p>Power Amplifier output is being fed back to IC-150 inputs via poor lead dress, AC mains from electrostatic speakers, etc.</p>
Low Frequency Oscillation	<p>Mechanical feedback between loudspeaker and turntable.</p> <p>Poor AC line voltage regulation causing power amplifier to feedback to unregulated equipment being used as signal source or speaker equalizer ahead of IC-150.</p>

TABLE 5-3. COMMON SYSTEM PROBLEMS

1. The first part of the document discusses the importance of maintaining accurate records of all transactions. It emphasizes that this is crucial for ensuring the integrity of the financial statements and for providing a clear audit trail.

2. The second part of the document outlines the various methods used to collect and analyze data. It includes a detailed description of the sampling process and the statistical techniques employed to interpret the results.

3. The third part of the document provides a comprehensive overview of the findings from the study. It highlights the key trends and patterns observed in the data and discusses their potential implications for the industry.

4. The fourth part of the document concludes the study by summarizing the main findings and offering recommendations for future research. It also includes a list of references and a list of figures and tables.

5. The fifth part of the document provides a detailed appendix of the data used in the study. This includes a list of all the variables measured and a description of the data collection process.

6. The sixth part of the document provides a detailed appendix of the statistical analysis. This includes a list of all the statistical tests used and a description of the results of each test.

7. The seventh part of the document provides a detailed appendix of the conclusions. This includes a list of all the conclusions drawn from the study and a description of the evidence supporting each conclusion.

SECTION 6
SCHEMATICS, PARTS LISTS AND
COMPONENT LOCATION

6.1 GENERAL INFORMATION

This section contains schematics, parts lists and exploded view drawings for the IC-150 Integrated Circuit Stereo Console. Used in conjunction with the service instructions in Section 5, this information will aid the service technician to rapidly and accurately identify and replace defective parts and return the unit to a normal operating condition.

6.2 PARTS REPLACEMENT

Many parts are standard items stocked by local electronics supply houses. However, some parts which appear to be standard are actually different. Best results will be obtained with CROWN factory replacement parts, although standard parts may be used in an emergency. A number of the parts are special and are available only from CROWN.

When ordering parts, be sure to give the amplifier model and serial number as well as the part number and description of the parts ordered.

6.3 SCHEMATICS AND PC BOARDS

Refer to Figures 6-1 through 6-10. Various versions of schematics, main PC boards, volume control PC boards, and phono PC boards have been used since the original IC-150 was produced. These changes are due to CROWN's continuing program of product improvement designed to bring you the best possible audio equipment. Table 6-1 shows the complement of schematics and PC boards applicable to your equipment. Simply find the serial number of your unit in the table.

SERIAL NUMBERS	SCHEMATIC	MAIN PC BOARD	VOLUME CONTROL PC BD	PHONO PC BOARD	OTHER INFORMATION
IC-100 thru IC-401	M243 (Fig. 6-4)	7867 (Fig. 6-5)	7868 (Fig. 6-8)	7829 (Fig. 6-9)	Original version of IC-150
IC-402 thru IC-761 and all A suffixes	M243A (Fig. 6-3)	7867 (Fig. 6-5)	7868 (Fig. 6-8)	7829 (Fig. 6-9)	LO Filter moved to input
IC-762 thru IC-949	M243B (Fig. 6-2)	7888 (Fig. 6-6)	None	7829 (Fig. 6-9)	Main and Volume Control PC boards combined.
IC-950 thru IC-2353	M243B (Fig. 6-2)	7888 (Fig. 6-6)	None	7829 (Fig. 6-9)	New volume control and circuitry changes.
IC-2354 and later	M243C (Fig. 6-1)	7923 (Fig. 6-7)	None	7999 (Fig. 6-10)	New IC, main board, relay, etc.

NOTES:

- IC-3074 thru IC-7273 R116 and R216 moved onto Phono PC Board.
- IC-7274 thru IC-7714 Both 7829 and 7999 Phono PC Boards were used interchangeably.
- IC-7715 and later New Phono PC Board 7999 used exclusively.
- IC-9912 and later CSA changes incorporated. Two 15K resistors added to schematic (R46, R57); see detail 25 Figure 6-11 for component location.

TABLE 6-1. SCHEMATIC AND PC BOARD COMPLEMENTS

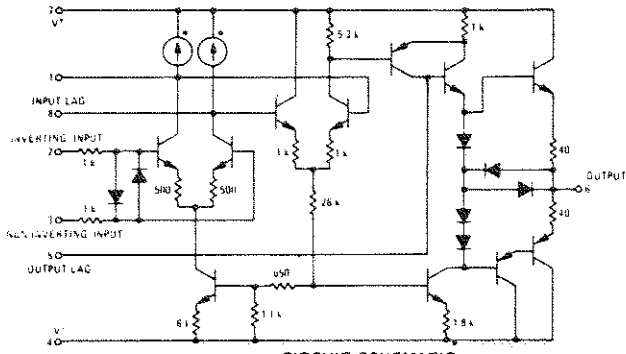

CIRCUIT SCHEMATIC

CPN 3225

MC. 1439G

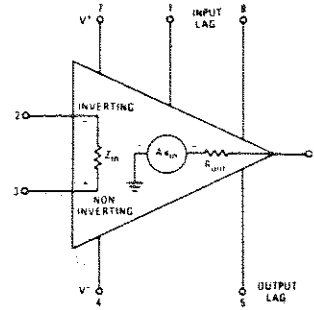

EQUIVALENT CIRCUIT

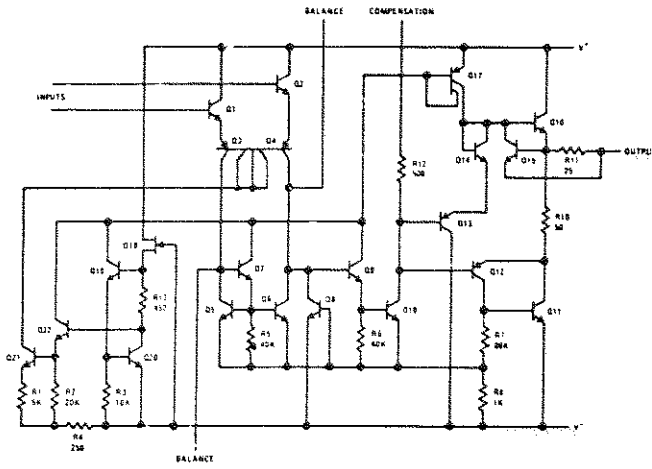

Schematic Representation of the LM301AN

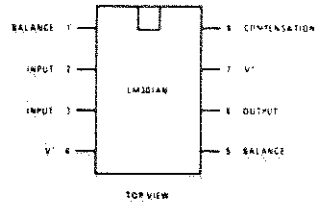

TOP VIEW

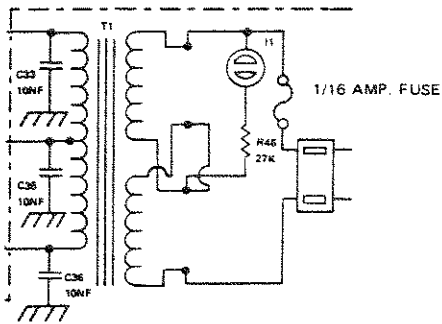

240 VAC WIRE

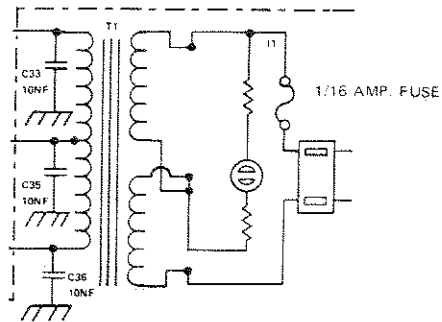

240 VAC WIRE

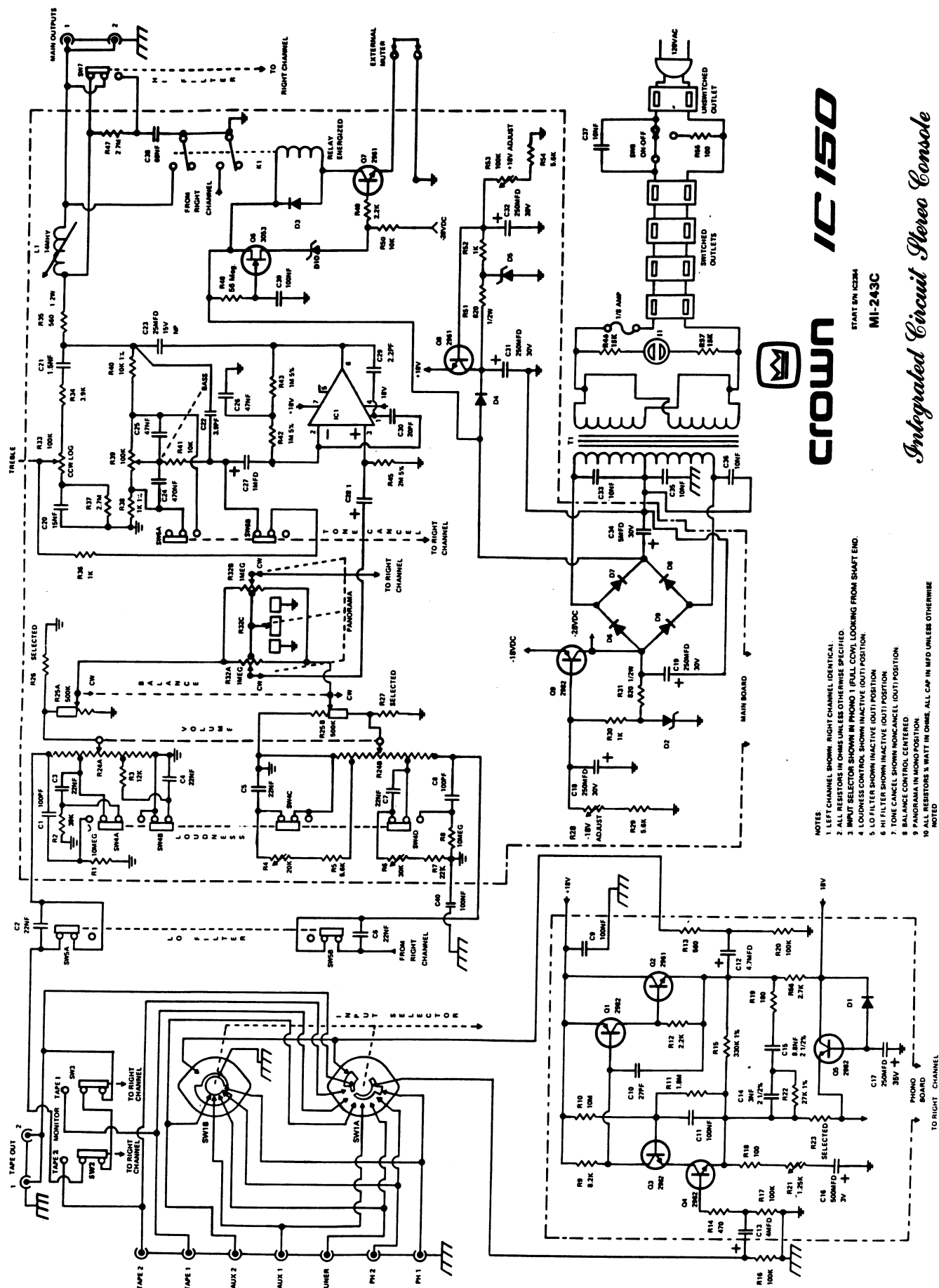

CROWN IC150
 START IN IC284
 MI-243C

Integrated Circuit Stereo Console

- NOTES
1. LEFT CHANNEL SHOWN. RIGHT CHANNEL IDENTICAL.
 2. ALL RESISTORS IN OHMS UNLESS OTHERWISE SPECIFIED.
 3. IC1 SELECTION SHOWN IN PHONO 1 (FULL CONV.) LOOKING FROM SHAFT END.
 4. IC1 FILTER SHOWN INACTIVE (00/1) POSITION.
 5. IC1 FILTER SHOWN ACTIVE (00/1) POSITION.
 6. IC1 FILTER SHOWN INACTIVE (00/1) POSITION.
 7. TONE CONTROL SHOWN MONO (00/1) POSITION.
 8. BALANCE CONTROL, CENTERED.
 9. PANORAMA IN MONO POSITION.
 10. ALL RESISTORS 1/2 WATT IN OHMS. ALL CAP IN MFD UNLESS OTHERWISE NOTED.
 11. IC1 CIRCUITRY SHOWN STARTS 5/N (IC-99)12

FIGURE 6-1.

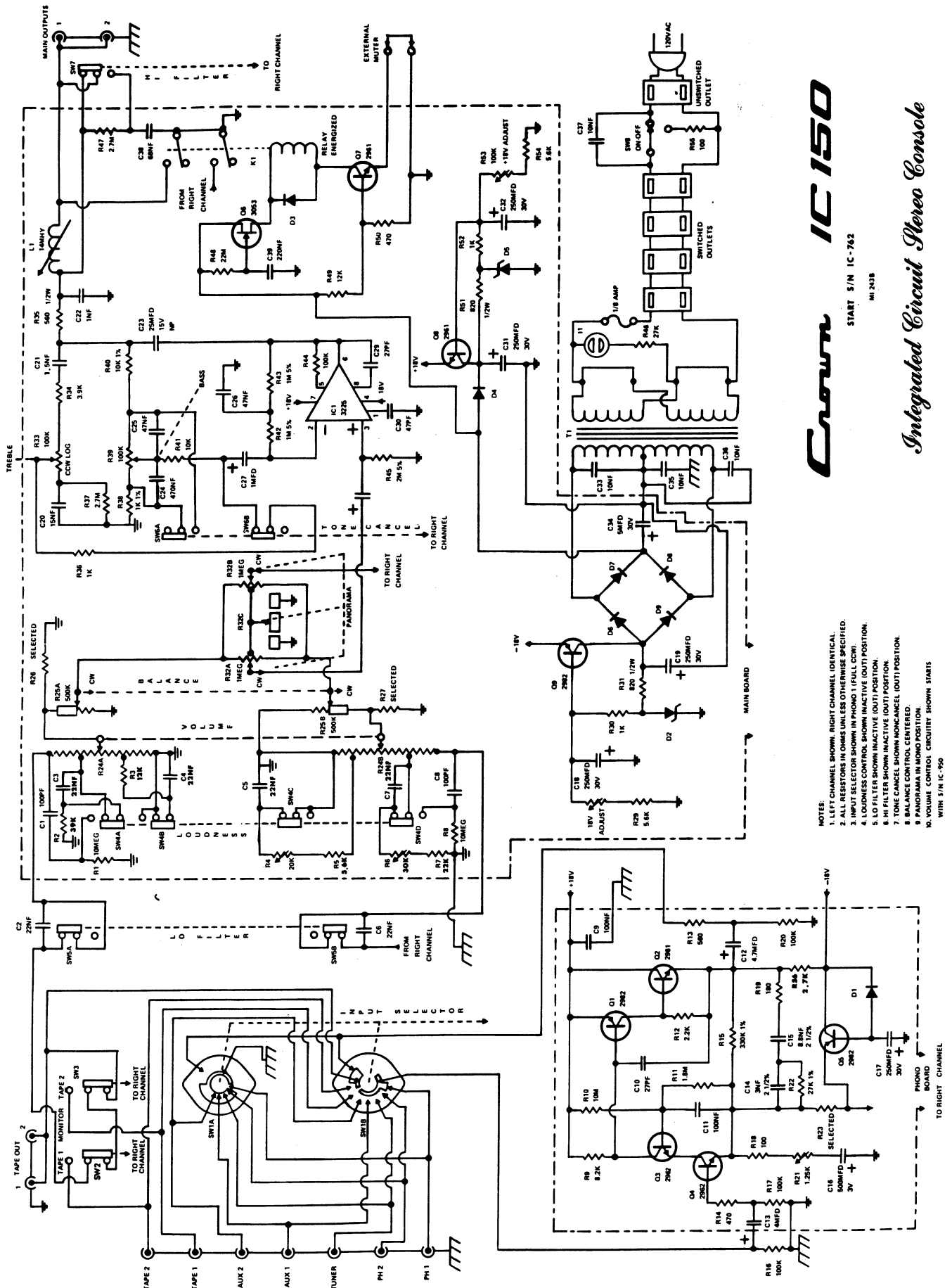

Crown IC 150

START 5/N IC-762
M1 208

Integrated Circuit Stereo Console

- NOTES:
1. LEFT CHANNEL SHOWN, RIGHT CHANNEL IDENTICAL.
 2. ALL RESISTORS IN OHMS UNLESS OTHERWISE SPECIFIED.
 3. INPUT SELECTOR SHOWN IN PHONO 1 (FULL CCM).
 4. LOUDNESS CONTROL SHOWN INACTIVE (OUT) POSITION.
 5. LO FILTER SHOWN INACTIVE (OUT) POSITION.
 6. HI FILTER SHOWN INACTIVE (OUT) POSITION.
 7. TONE CANCEL SHOWN NONCANCEL (OUT) POSITION.
 8. BALANCE CONTROL CENTERED.
 9. PANORMIA IN MONO POSITION.
 10. VOLUME CONTROL CIRCUITRY SHOWN STARTS WITH 5/N IC-150

FIGURE 6-2.

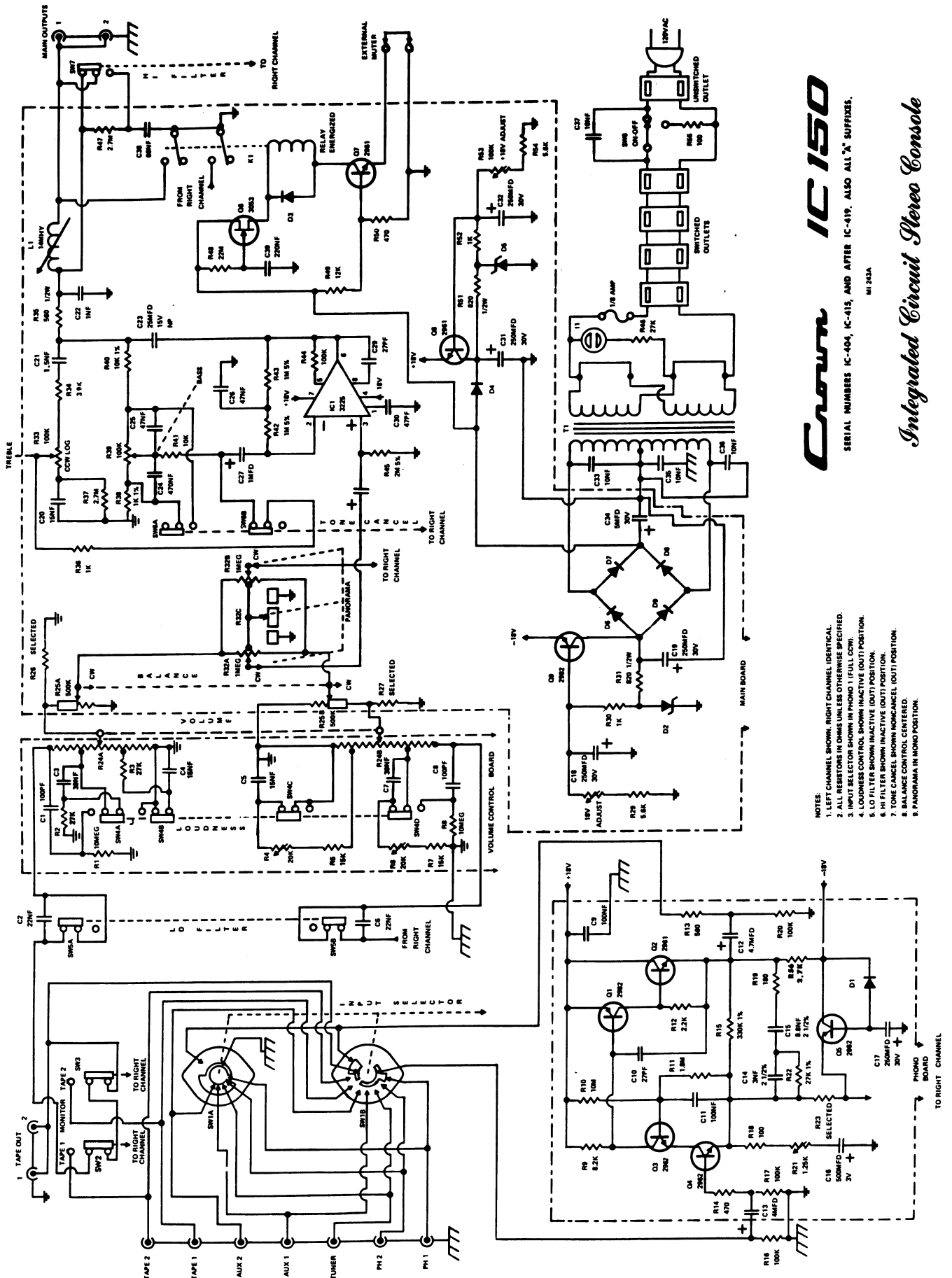

- NOTES:
1. LEFT CHANNEL SHOWN, RIGHT CHANNEL IDENTICAL.
 2. ALL RESISTORS IN OHMS UNLESS OTHERWISE SPECIFIED.
 3. INPUT SELECTOR SHOWN IN PHONO 1 (FULL COIL).
 4. LOUNESS CONTROL SHOWN INACTIVE (OUT) POSITION.
 5. LO FILTER SHOWN INACTIVE (OUT) POSITION.
 6. HI FILTER SHOWN INACTIVE (OUT) POSITION.
 7. 100V CAPACITOR SHOWN IN ACTIVE (OUT) POSITION.
 8. PANORAMA IN MONO POSITION.

Crown IC 150

SERIAL NUMBERS IC-404, IC-415, AND AFTER IC-419. ALSO ALL "X" SUFFIXES.

MI 2424

Integrated Circuit Stereo Console

FIGURE 6-3.

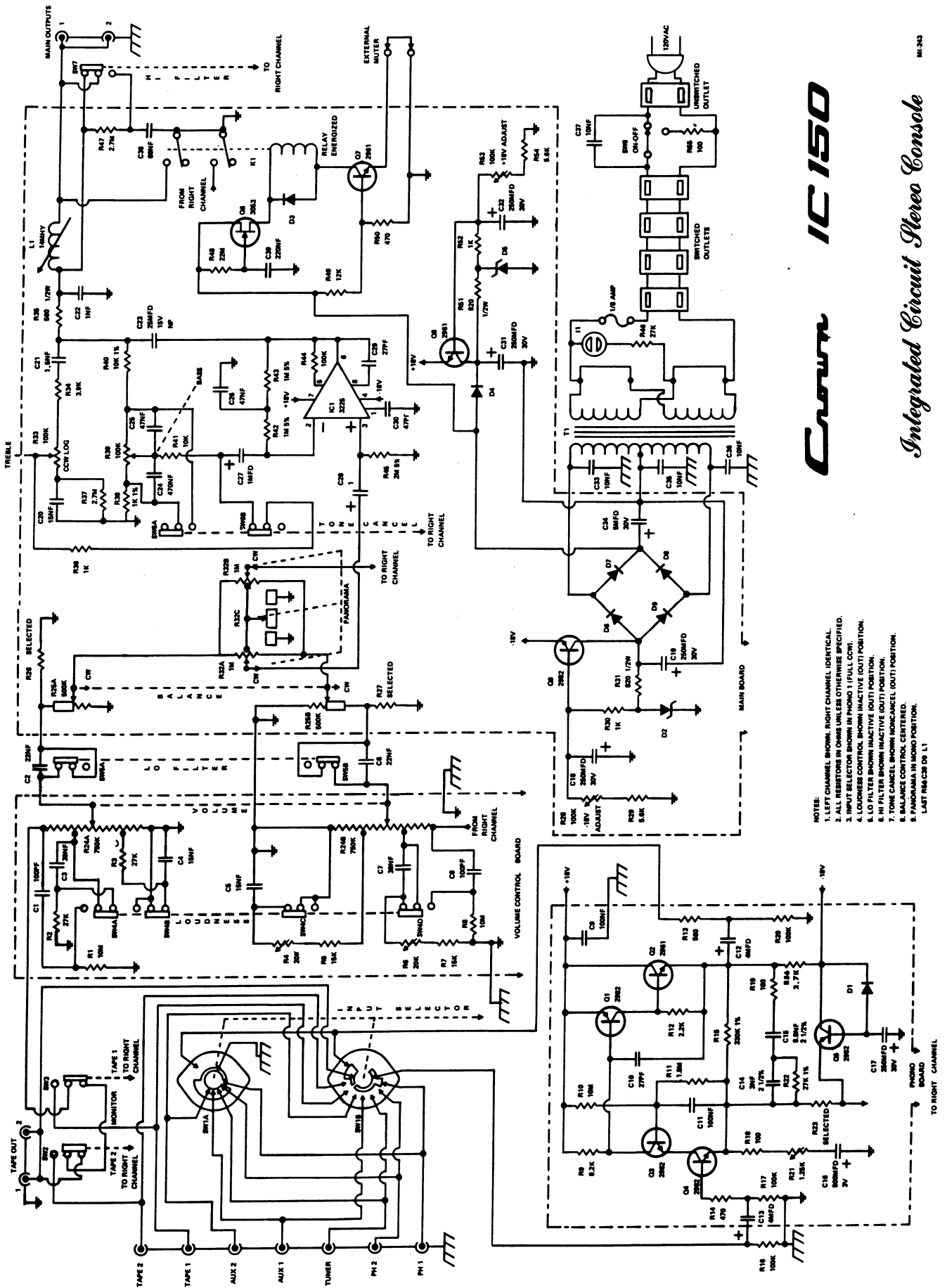

- NOTE:
1. LEFT CHANNEL SHOWN, RIGHT CHANNEL IDENTICAL.
 2. ALL RESISTORS IN OHMS UNLESS OTHERWISE SPECIFIED.
 3. INPUT SELECTOR SHOWN IN PHONO 1 (FULL CW).
 4. LOUDNESS CONTROL SHOWN INACTIVE (OUT) POSITION.
 5. LO FILTER SHOWN INACTIVE (OUT) POSITION.
 6. HI FILTER SHOWN INACTIVE (OUT) POSITION.
 7. TONE CONTROL SHOWN INACTIVE (OUT) POSITION.
 8. BALANCE CONTROL CENTERED.
 9. PANOGRAM IN PHONO POSITION.
 10. LAST TWO C89 (9, 1)

Crown IC150

Integrated Circuit Stereo Console

FIGURE 6-4.

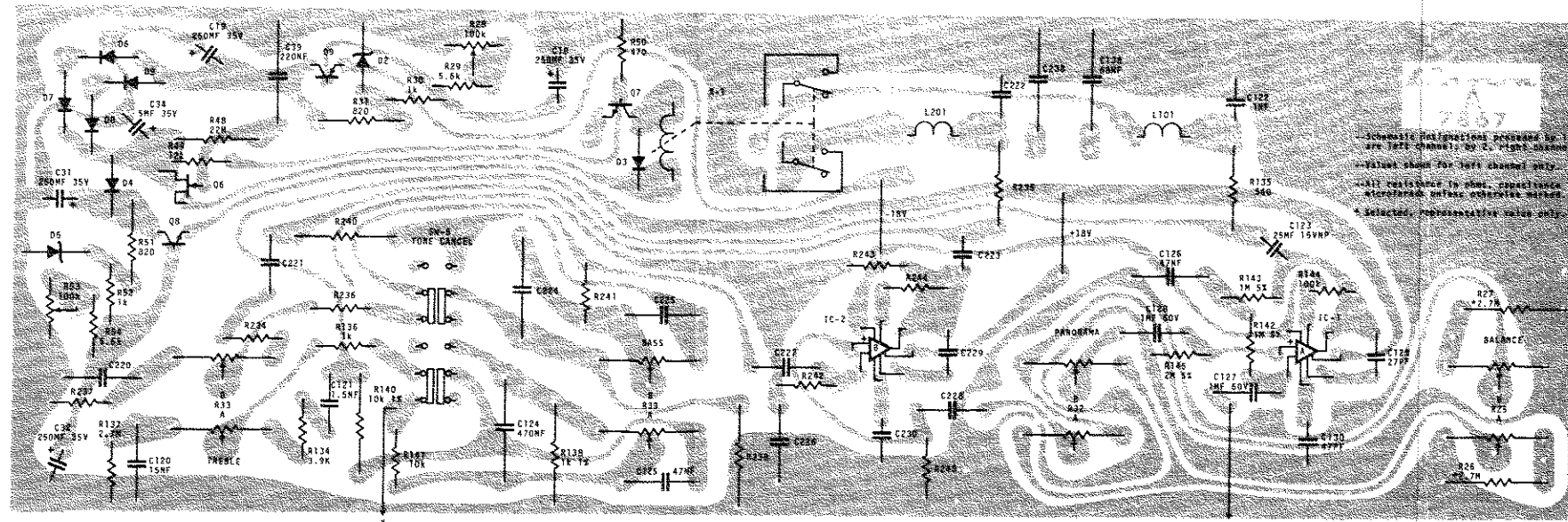

PARTS LIST: IC-150

Schematic Designation	Description	Crown Part No.	Draw No.	Other Information	Schematic Designation	Description	Crown Part No.	Draw No.	Other Information
	MAIN PC BOARD	7867							
	Capacitors:								
C18, C19, C31, C32	250 MFD, 35V	3787			R142, R242 R143, R243	1 Megohm, .25W, 5%	3198		
C34	5 MFD, 35V, vertical	2868			R144, R244	100K Ohms, .25W, 10%	2883		
C39	220 NF, filmatic, mylar	3218			R145, R245	2 Megohm, .25W, 5%	3199		
C120, C220	15 NF, filmatic, mylar	3288				Semiconductors:			
C121, C221	1.5 NF, filmatic, mylar	3089			Q6	2N5459, NCH JFET	3053		
C122, C222	1 NF, ceramic disc	2288			Q7, Q8	2N3859A, selected	2961		
C123, C223	25 MFD, 115V, NP, vertical	3186			Q9	2N5383, selected	2982		
C124, C224	470 NF, filmatic, mylar	3191			D2, D5	1N968B, Zener diode	3277		
C125, C126, C225, C226	47 NF, filmatic, mylar	2977			D3, D4, D7, D8, D9, D6	1N4148, diode	3181		
C127, C128, C227, C228	1 MFD, 60V	1750			IC1, IC2	MC1439G	3225		
C129, C229	27 PF, mica	2342			or	or			
C130, C230	47 PF, mica	3409			IC1, IC2	SC17011G	3460		
C138, C238	68 NF, filmatic, mylar	3190				Miscellaneous:			
R25	BALANCE control	3238			L1, L2	Coil, 14 mhy	1661		
R26, R27	2.7 Megohm, .25W, 10%	2634		Selected, typical value only	K1	Relay, 5000 Ohm, DPDT	3223		
R28, R53	100K Ohms, potentiometer	3242		- and + 18V adjust	SW6	Switch, 4PDT, PB	3226	FLAT (Tone Cancel)	
R29, R54	5.6K Ohms, .25W, 10%	3220				CHASSIS MOUNTED PARTS used with Main PC Board, 7867			
R30, R52, R136, R236	1K Ohms, .25W, 10%	2627				Capacitors:			
R31, R51	820 Ohms, .5W, 10%	2580			C2, C6	.022 MFD, filmatic, mylar	2963		
R32	PANORAMA control	3239			C33, C35-C37	.01 MFD, ceramic disc	1751		
R33, R39	TONE control, 100K Ohms	3240		BASS and TREBLE		Fuses:			
R48	22 Megohm, .5W, 10%	3052			F1	3AG, 1/8 Amp	3228	120V operation	
R49	12K Ohms, .25W, 10%	2878			or				
R50	470 Ohms, .25W, 10%	2626			F1	AGC, 1/16 Amp	3707	220V operation	
R134, R234	3.9K Ohms, .25W, 10%	2630			I1	Lamp, neon, NE-2H	2500		
R135, R235	560 Ohms, .5W, 10%	1030				Resistors:			
R137, R147, R237, R247	2.7 Megohm, .25W, 10%	2634			R46	27K Ohms, .5W, 10%	1056		
R138, R238	1K Ohms, .5W, 10%	3194			R55	100 Ohms, .5W, 10%	1007		
R140, R240	10K Ohms, .5W, 1% film	2343			R116, R216	100K Ohms, .25W, 10%	2883		
R141, R241	10K Ohms, .25W, 10%	2631				Switches:			
					SW1	Input selector switch	3359		
					SW2, SW3, SW5, SW7	5-station, PB switch	3227		
					SW8	POWER (micro)	3222		
					T1	Transformer: 46-P-19B	3224		

FIGURE 6-5. COMPONENT LOCATION, MAIN PC BOARD, 7867

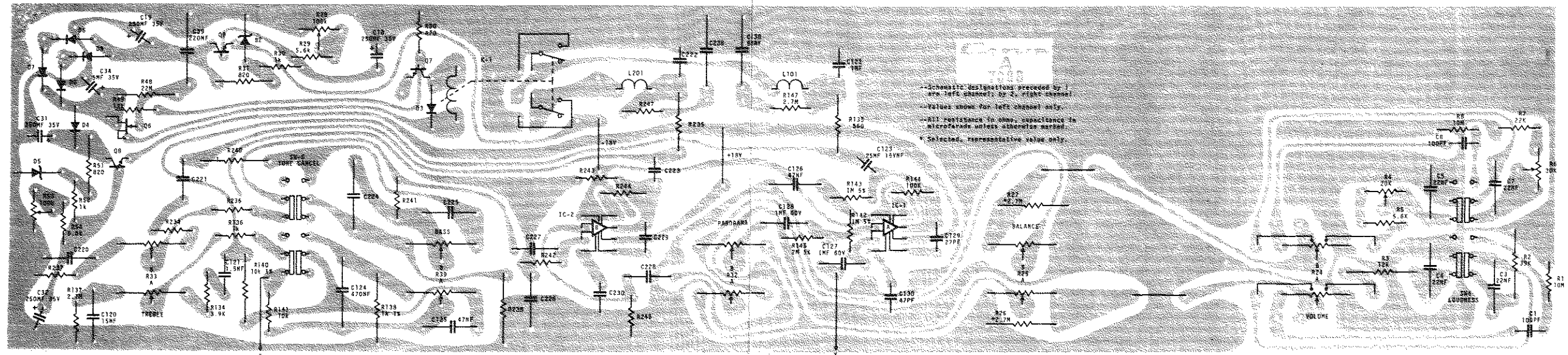

PARTS LIST: IC-150

Schematic Designation	Description	Crown Part No.	Draw No.	Other Information	Schematic Designation	Description	Crown Part No.	Draw No.	Other Information
MAIN PC BOARD				7888					
Capacitors:									
C1, C8	100 PF, mica	3410			R32	PANORAMA control	3239		
C3, C4, C5, C7	22 NF, filmatic, mylar	2963			R33, R39	TONE control	3240		
C18, C19, C31, C32	250 MFD, 35V, vertical	3787			R48	22 Megohm, .5W, 10%	3052		
C34	5 MFD, 35V, vertical	2868			R49	12K Ohm, .25W, 10%	2878		
C39	220 NF, filmatic, mylar	3218			R50	470 Ohm, .25W, 10%	2626		
C120, C220	15 NF, filmatic, mylar	3288			R52, R30, R136, R236	1K Ohm, .25W, 10%	2627		
C121, C221	1.5 NF, filmatic, mylar	3089			R134, R23	3.9K Ohm, .25W, 10%	2630		
C122, C222	1 NF, ceramic disc	2288			R135, R235	560 Ohm, .5W, 10%	1030		
C123, C223	25 MFD, 15V, NP	3186			R137, R147, R237, R247	2.7 Megohm, .25W, 10%	2634		
C124, C224	470 NF, filmatic, mylar	3191			R138, R238	1K Ohm, .5W, 1% film	3194		
C125, C126, C225, C226	47 NF, filmatic, mylar	2977			R140, R240	10K Ohm, .5W, 1% film	2343		
C127, C128, C227, C228	1 MFD, 60V, tantalum	1750			R141, R241	10K Ohm, .25W, 10%	2631		
C129, C229	27 PF, mica	2342			R142, R143, R242, R243	1 Megohm, .25W, 5%	3198		
C130, C230	47 PF, mica	3409			R144, R244	100K Ohm, .25W, 10%	2883		
C138, C238	68 NF, filmatic, mylar	3190			R145, R245	2 Megohm, .25W, 5%	3199		
Resistors:									
R1, R8	10 Megohm, .25W, 10%	3221			Semiconductors:				
R2	39K Ohm, .25W, 10%	2879			Q6	2N5459, NCH JFET	3053		
R3	12K Ohm, .25W, 10%	2878			Q7, Q8	2N3859A, selected	2961		
R4	20K Ohm, PC, potentiometer	1712			Q9	2N5383, selected	2982		
R5, R29, R54	5.6K Ohm, .25W, 10%	3220			D2, D5	1N968B, Zener diode	3277		
R6	30K Ohm, PC, potentiometer	2298			D3, D4, D6-D9	1N4148, diode	3181		
R7	22K Ohm, .25W, 10%	3302			IC1, IC2	MC1439G	3225		
R24	VOLUME control	3422			or				
R25	BALANCE control	3238			IC1, IC2	SC17011G	3460		
R26, R27	2.7 Megohm, .25W, 10%	2634			Miscellaneous:				
R28, R53	100K Ohm, PC, potentiometer	3242			K1	Relay, 5000 Ohm, DPDT	3227		
R31, R51	820 Ohm, .25W, 10%	2580			L1, L2	Coil, 14 mhy	1661		
					SW4, SW6	Switch, 4PDT, PB	3226		

FIGURE 6-6. COMPONENT LOCATION, MAIN PC BOARD, 7888

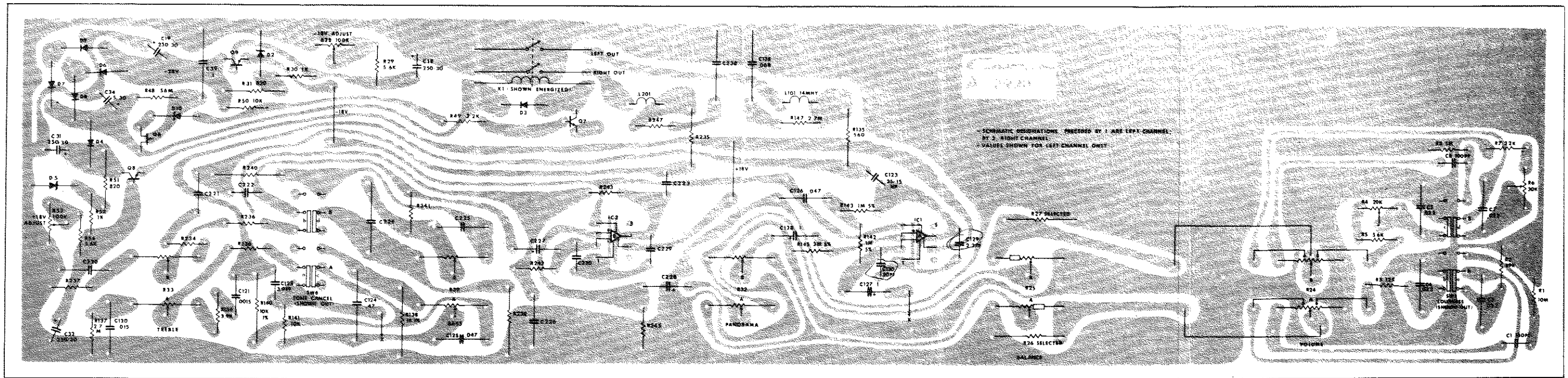

PARTS LIST: IC-150

Schematic Designation	Description	Crown Part No.	Other Information	Schematic Designation	Description	Crown Part No.	Schematic Designation	Description	Crown Part No.	Other Information	
IC MAIN MODULE											
	IC-150 Main PC Board	41136MT	All parts except wire or CPN 7923 (interchangeable)								
Capacitors:				Resistors:							
C1, 8	100 pf, mica	3410		R1, 8	10 megohm, .25W, 10%	3221	Q6	2N5459, NCH, JFET	3053		
C3, 4, 5, 7	.022 mfd, 200V, filmatic	2963		R2	39K ohm, .25W, 10%	2879	Q7, 8	2N3859A, selected	2961		
C18, 19, 31, 32	250 mfd, 35V, vertical	3787		R3	12K ohm, .25W, 10%	2878	Q9	2N5383, selected	2982		
C34	5 mfd, 30V, vertical	2868		R4	20K ohm, vertical potentiometer	1712	Miscellaneous:				
C39, 40	.1 mfd, filmatic, mylar	2938	C40 from board to chassis	R5, 29, 54	5.6K ohm, .25W, 10%	3220	Spacers			3210	Use on control shafts, inside front panel
C120, 220	.015 mfd, 200V, filmatic	3288		R6	30K ohm, vertical potentiometer	2298	Lockwasher, star, 3/8", internal			2188	Use on control shafts, inside front panel
C121, 221	.0015 mfd, 200V, filmatic	3089		R7	22K ohm, .25W, 10%	3302	Washer, control bright			2189	Use on control shafts, outside front panel
C122, 222	3.9 pf, ceramic	2937		R24 (A & B)	VOLUME control	3422	Nut, bright, 3/8", NIC			1288	Use on control shafts, outside front panel
C123, 223	25 mfd, 15V, NP, vertical	3186		R25 (A & B)	BALANCE control	3238	Socket, IC, 8-pin			3451	Use on IC-1, IC-2
C124, 224	.47 mfd, 100V, filmatic	3191		R28, 53	100K ohm, vertical, CCW/log	3242					
C125, 126, 225, 226	.047 mfd, 200V, filmatic	2977		R30, 52, 136, 236	1K ohm, .25W, 10%	2627					
C127, 128, 227, 228	1 mfd, 30V, tantalum	1750		R31, 51	820 ohm, .5W, 10%	2580					
C129, 229	2.2 pf, ceramic	3534		R32, (A&B&C)	PANORAMA control	3239					
C130, 230	20 pf, ceramic	3535		R33 (A & B); R39 (A & B)	TONE controls	3240					
C138, 238	.068 mfd, 200V, filmatic	3190		R48	56 megohm, .25W, 10%	3536					
Coil: 12 mhy				R49	2.2K ohm, .25W, 10%	2628					
Diodes:				R50, 141, 241	10K ohm, .25W, 10%	2631					
L101, L102		1661		R134, 234	3.9K ohm, .25W, 10%	2630					
D2, 5	1N968B, 20V, Zener	3277		R135, 235	560 ohms, .5W, 10%	1030					
D3, 4, 6-9	1N4148	3181		R137, 147, 237, 247	2.7 megohm, .25W, 10%	2634					
D10	1N966B, 16V, Zener	3533		R138, 238	1K ohm, .5W, 1%, film	3194					
IC1, 2	Integrated Circuit: 301 AN OP Ampl	3532		R140, 240	10K ohm, .5W, 1%, film	2343					
K1	Relay: 5K ohm, DPDT, NC, reed	3496		R142, 143, 242, 243	1 megohm, .25W, 5%	3198					
				R145, 245	2 megohm, .25W, 10%	3199					
				SW4, 6	Switch: pushbutton	3226					

FIGURE 6-7. COMPONENT LOCATION, MAIN PC BOARD, 7923

PARTS LIST: IC-150

Schematic Designation	Description	Crown Part No.	Draw No.	Other Information
	VOLUME CONTROL BOARD	7868		
	Capacitors:			
C1, C8	100 PF, mica	3410		
C3, C7	39 NF, filmatic	3189		
C4, C5	15 NF, filmatic	3288		
	Resistors:			
R1, R8	10 Megohm, .25W, 10%	3221		
R2, R3	27K Ohms, .5W, 10%	1056		
R4, R6	20K Ohms, vertical potentiometer	1712		
R5, R7	15K Ohms, .25W, 10%	2632		
R24	Volume Control	3237		

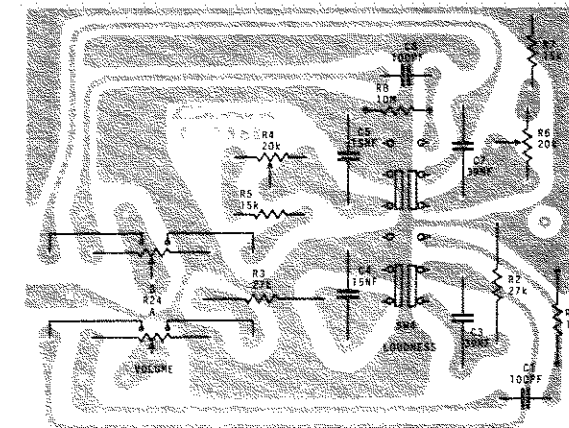

FIGURE 6-8. COMPONENT LOCATION VOLUME CONTROL BOARD, 7868

PARTS LIST: IC-150

Schematic Designation	Description	Crown Part No.	Draw No.	Other Information
PHONO PC BOARD		7829		
Capacitors:				
C9, C111, C211	100 NF, filmatic mylar	2938		
C17	250 MFD, 35V, vertical	3787		
C110, C210	27 PF, mica	2342		
C112, C113, C212, C213	4.7 MFD, 20V, tantalum	3337		
C114, C214	3000 PF, poly	3187		
C115, C215	8800 PF, poly	3188		
C116, C216	500 MFD, 3V, vertical	3192		
Resistors:				
R109, R209	8.2K Ohms, .25W, 10%	2877		
R110, R210	10 Megohm, .25W, 10%	3221		
R111, R211	1.8 Megohm, .25W, 10%	2887		
R112, R212	2.2K Ohms, .25W, 10%	2628		
R113, R213	560 Ohms, .25W, 10%	2874		
R114, R214	470 Ohms, .25W, 10%	2626		
R115, R215	330K Ohms, .5W, 1%, metal film	3196		
R117, R120, R217, R220	100K Ohms, .25W, 10%	2883		
R118, R218	100 Ohms, .25W, 10%	2872		
R119, R219	180 Ohms, .25W, 10%	2873		
R121, R221	1.25K Ohms, potentiometer	3241		
R122, R222	27K Ohms, .5W, 1%, metal film	3195		
R123, R223	200K Ohms, .5W, 1%, metal film	3196		
R156, R256	2.7K Ohms, .5W, 10%	1067		
Semiconductors:				
Q5, Q101, Q201	PN4250A, selected	3786		
Q102, Q202	2N3859A, selected	2961		
Q103, Q104, Q203, Q204	T2-81	2962		
D-1	1N4148, diode	3181		
Miscellaneous:				
	PC receptacles	3519		Used on Q101, Q104, Q201, Q204

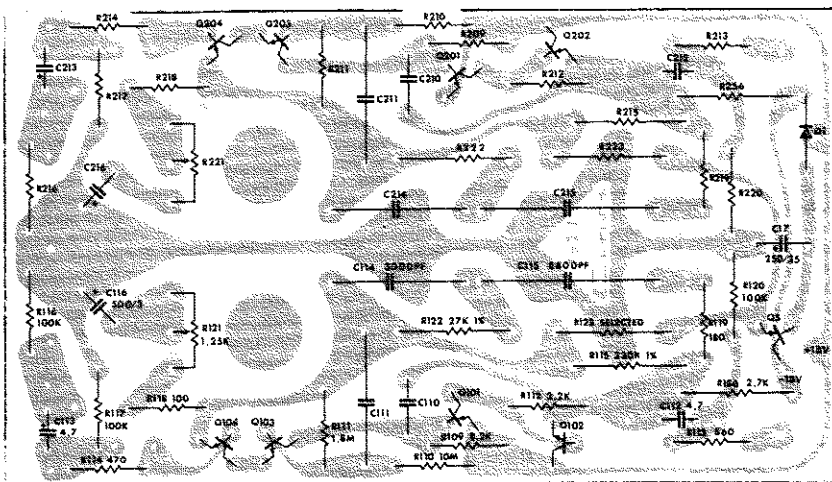

FIGURE 6-9. COMPONENT LOCATION, PHONO PC BOARD, 7829

Schematic Designation	Description	Crown Part No.	Draw No.	Other Information
	Phono PC Board:	7999		7829u used on early units
	Capacitors:			
C9, 111, 211	.1 mfd, 200V, filmatic	2938		C9 mounts from board to chassis solder lug
C17	250 mfd, 35V, vertical	3787		
C110, 210	27 pf, mica	2342		
C112, 113, 212, 213	4.7 mfd, 20V, tantalum	3337		
C114, 214	3000 pf, polystyrene	3187		
C115, 215	8800 pf, polystyrene	3188		
C116, 216	500 mfd, 3V, vertical	3192		
	Resistors:			
R109, 209	8.2K ohm, .25W, 10%	2877		
R110, 210	10 megohm, .25W, 10%	3221		
R111, 211	1.8 megohm, .25W, 10%	2887		
R112, 212	2.2K ohm, .25W, 10%	2628		
R113, 213	560 ohm, .25W, 10%	2874		
R114, 214	470 ohm, .25W, 10%	2626		
R115, 215	330K ohm, .5W, 1% film	3196		
R116, 117, 120, 216, 217, 220	100K ohm, .25W, 10%	2883		R116, 216 mounted on input selector switch on early units
R118, 218	100 ohm, .25W, 10%	2872		
R119, 219	180 ohm, .25W, 10%	2873		
R121, 221	1.25K ohm, potentiometer	3241		Input level adjust: on amplifier rear panel
R122, 222	27K ohm, .5W, 1% film	3195		
R123, 223	200K ohm, .5W, 1% film	3197		
R156, 256	2.7K ohm, .5W, 10%	1067		
	Transistors:			
Q5, 101, 201	2N5383, selected	2982		
Q102, 202	2N3859A, selected	2961		
Q103, 104, 203, 204	TZ81, selected	2962		
D-1	Diode: 1N4148	3181		
	Miscellaneous:			
	Transistor lead, PC receptacle	3519		Used on Q101, 104, 201, 204

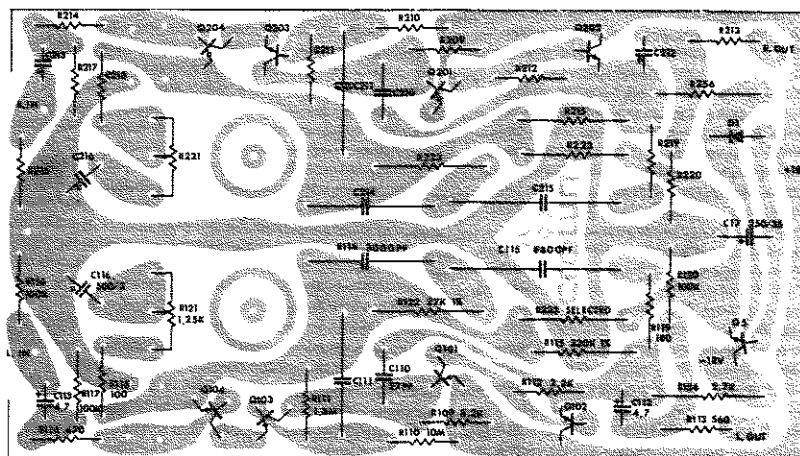

FIGURE 6-10. COMPONENT LOCATION, PHONO PC BOARD, 7999

PARTS LIST: IC-150

Schematic Designation	Description	Crown Part No.	Draw No.	Other Information
	CHASSIS ASSEMBLY	40821		
	Chassis:	3540		
	Top shield	3353	1	Includes silkscreen
	Screw, #8 x 3/8 hex, SM	2708	2	Fastens 3353 to chassis
	Front panel, IC	3461	3	
	Screw, 6-32 x 3/8 hex	3322	4	Fastens 3461 to chassis
	Washer, star, #6 internal	1823	5	Used over 3322
	Nut, hex, 6-32, CAD	1889	6	Used over 3322
	Bottom shield	3354	7	
	Screw, #8 x 3/8 SM	2708	8	Used to fasten 3354
	Screw, 8-32 x 3/8 THP CHR	2155	9	Used to fasten T1
	Washer, star, #8 internal	1951	10	Use over 2155
	Nut, hex, 8-32, CAD	1986	11	Use over 2155
	Terminal strip, 1-G-2	1266	12	Use over one screw of transformer T1
	Bushings, snap, 3/8"	2412	13	Used to pass wires through chassis
	Receptacle, AC NG	2432	14	
	Binding post, dual	2823	15	MUTE terminals
	Tape, foam, 1/2" W	2693	16	Used on top of top shield
	Screw, 6-32 x 1", CAD	2138	17	Used to mount SW8
	Nut, 6-32, hex, CAD	1889	18	Used to mount SW8
	Spacer, micro-switch	3211	19	Used to mount SW8
	Fuseholder, HTA	3256	20	
	Fuse, 3 AG, 1/2 A	3228	21	
	Fuse, AGC, 1/16 A	3707	22	For use on units converted to 240 VAC
	Strain relief, right angle	3236	23	
	Power Cord, HPN	3246	24	
	Terminal Strip, G-6-G	1273	25	
	Screw, hex, #8 x 38 5M	2708	26	Fastens 1273 terminal strip
	Binding post	3245	27	
	Solder lug, #8 hole	2935	28	One mounts over 3245; two fastens C9, C40
	Nut, hex, 8-32 CAD	1986	29	Mounts 3245 to chassis
	Screw, hex, #8 x 3/8 SM	2708	30	Fastens C9, C40
C33, 35, 36, 37	Capacitor: .01 mfd, ceramic disc	1751		Mounted on terminal strip
I-1	Lamp: NE24, neon	2500		Mounted on terminal strip
	Resistors: .5W, 10%			
R46	27K ohms	1056		Mounted on terminal strip
R55	100 ohm	1007		Mounted on terminal strip
SW8	Switch: SPDT, 25A, micro	3222		
T1	Transformer: 46P19B	3224		
	NOTE:			
	After IC-9912, R46 becomes 2 15K resistors			
R46, R57	15K ohm, .5W 10%	1064		Mounted on terminal strip

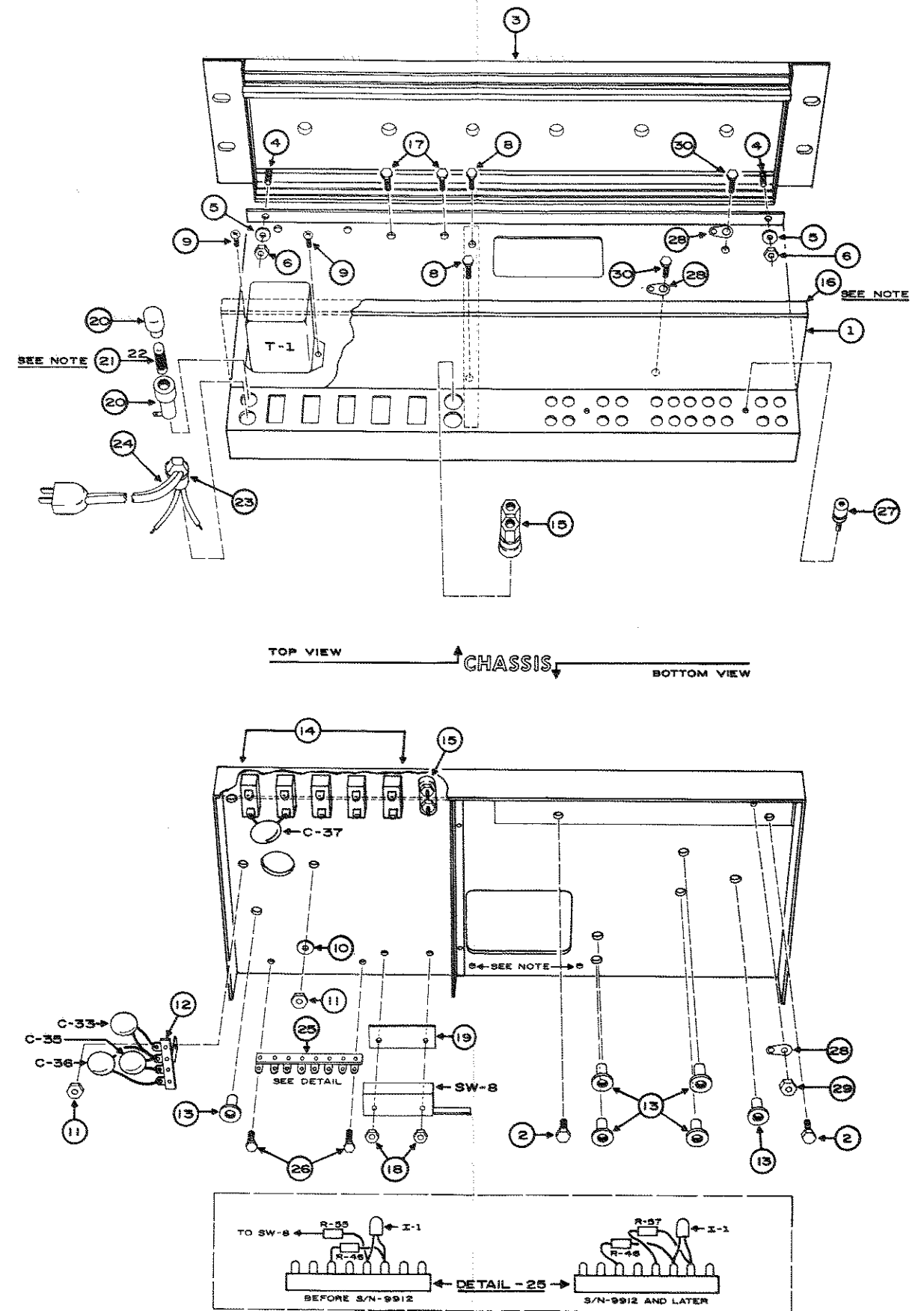
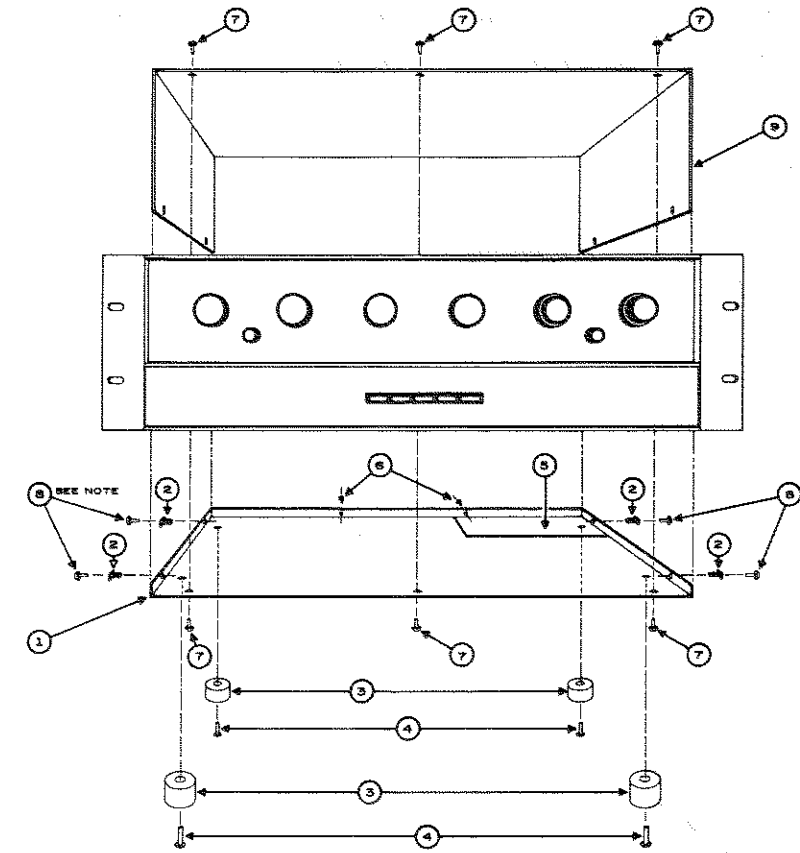
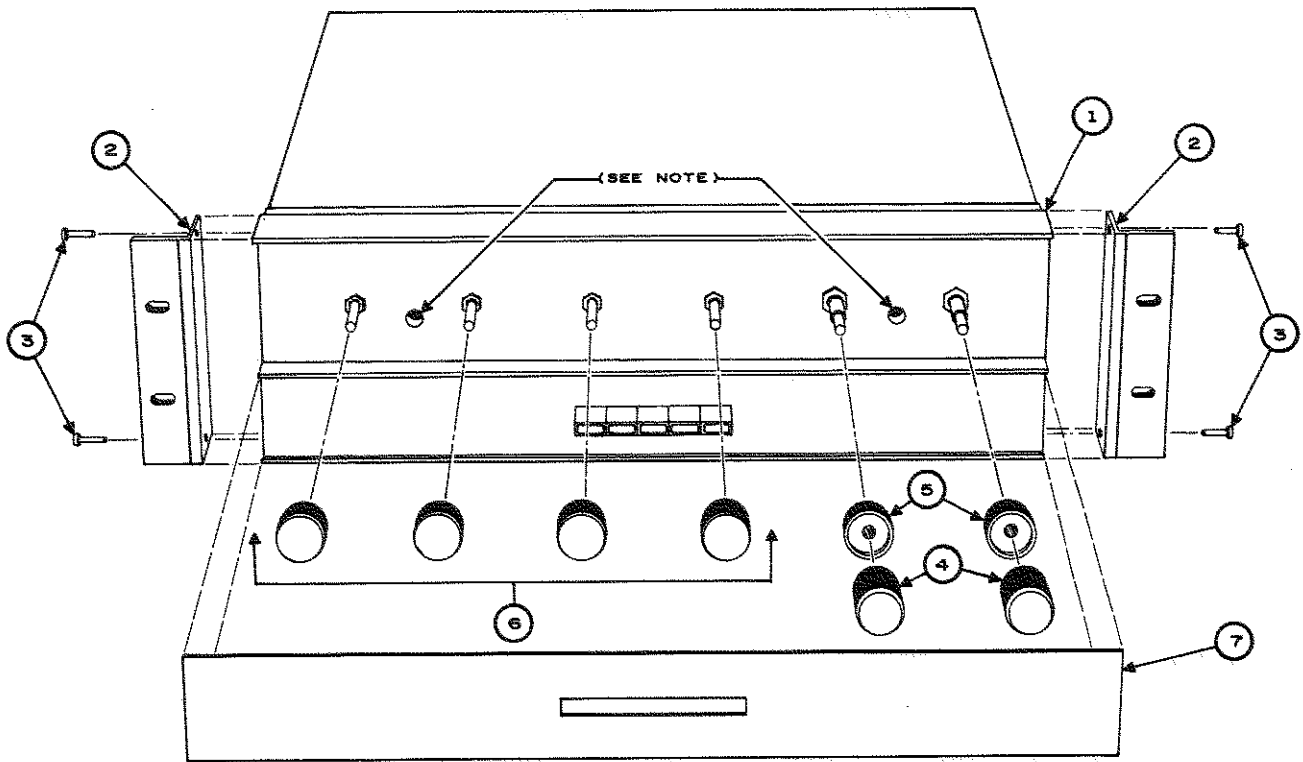

FIGURE 6-11. CHASSIS ASSEMBLY, 40821



Schematic Designation	Description	Crown Part No.	Draw No.	Other Information
	BOTTOM COVER ASSEMBLY	40829		
	Bottom cover	3351	1	
	Nuts, flush expansion	2543	2	Mounted in bottom cover
	Rubber feet (4)	2945	3	
	Screw, #8 x 1, CAD	2088	4	Mounts rubber feet
	Fishpaper, 2" x 6"	3278	5	Insulates AC receptacles
	Screw, hex, #8 x 3/8 SM	2708	6	Fastens back of bottom cover
	Screw, #8 x 3/8 SM CHR	3319	7	Fastens front of top and bottom covers
	Screw, #8-32 x 3/8 THP CHR	2155	8	Fastens sides of top and bottom covers. NOTE.
	TOP COVER	3352	9	
	NOTE: Screws go through sides of both top and bottom covers, and into the flush expansion nuts.			

FIGURE 6-12. EXPLODED VIEW DIAGRAM
BOTTOM COVER ASSEMBLY, 40829



Schematic Designation	Description	Crown Part No.	Draw No.	Other Information
FRONT PANEL ASSEMBLY AND LABELS				
	Front panel	3461	1	
	End bars, brushed aluminum	3462	2	
	Screw, cap, 6-32 x 3/4	1858	3	Fastens end bars
	Knob, control, # B	3254	4	Inner BASS & TREBLE
	Knob, control, # C	3255	5	Outer BASS & TREBLE
	Knob, control, # A	3253	6	SELECTOR, VOLUME, BALANCE, PANORAMA
	Overlay, front panel	3416	7	
	Plate, serial number	3693	NOT SHOWN	Attached to rear panel of amplifier.

FIGURE 6-13. EXPLODED VIEW DIAGRAM
FRONT PANEL ASSEMBLY AND LABELS

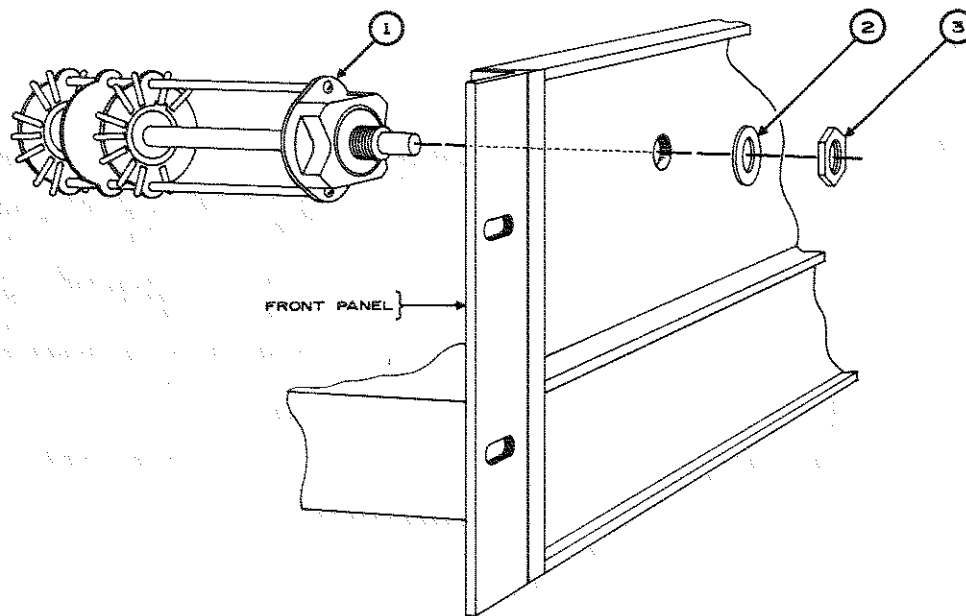

Schematic Designation	Description	Crown Part No.	Draw No.	Other Information
	INPUT SELECTOR SWITCH ASSEMBLY	40825		
SW1	Switch, selector	3359	1	
	Washer, bright, control	2189	2	Use over switch shaft
	Nut, bright, control	1288	3	

FIGURE 6-14. INPUT SELECTOR SWITCH ASSY., 40825

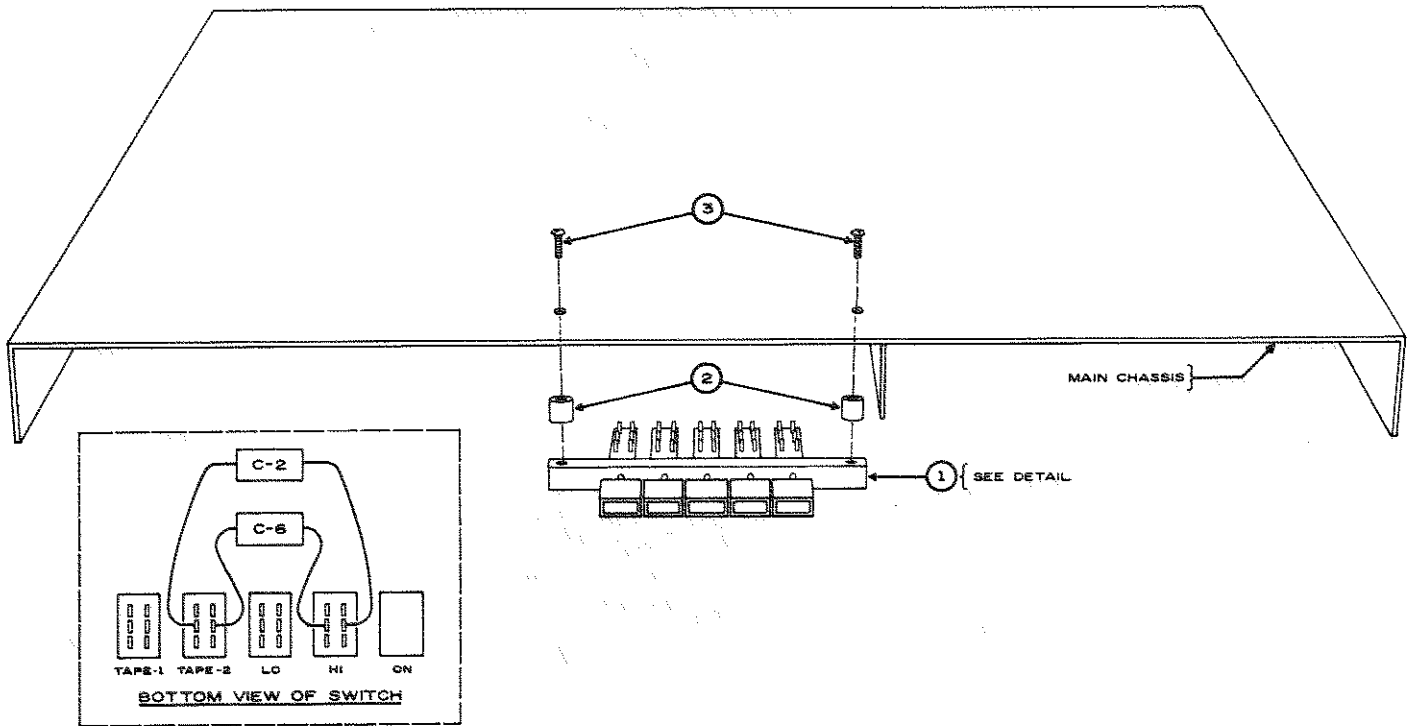

Schematic Designation	Description	Crown Part No.	Draw No.	Other Information
	PUSHBUTTON SWITCH ASSEMBLY	40817		
SW3, 5, 7	Pushbutton, IC-150, 5-button	3227	1	
	Spacer, brass	3212	2	Used to mount switch
	Screw, 3-48 x 1/2, slotted, CAD	2438	3	Used to mount switch
C2, C6	Capacitor, .022 mfd, filmatic	2963	4	Mounted on switch terminals

FIGURE 6-15. PUSHBUTTON SWITCH ASSY., 40817

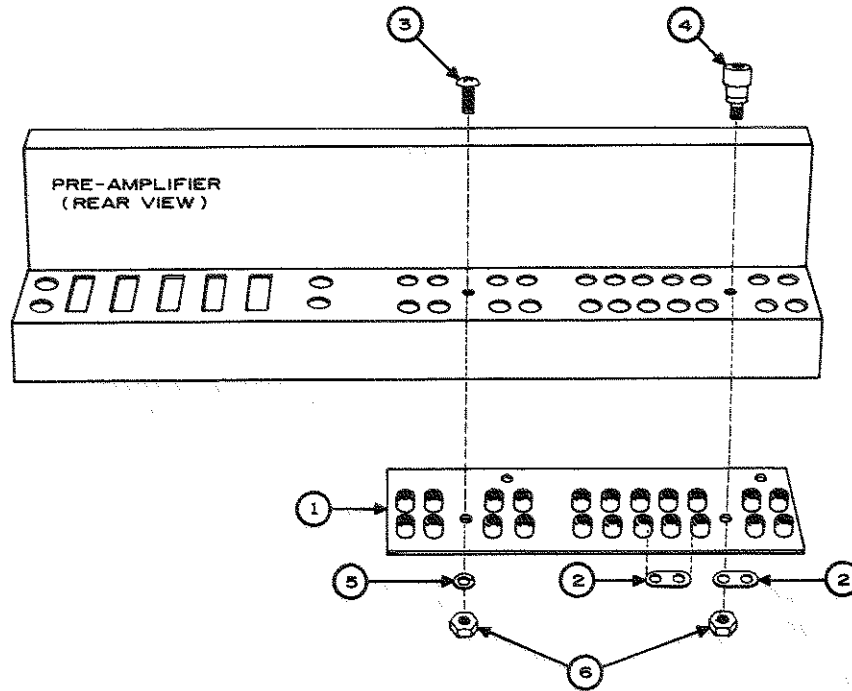

Schematic Designation	Description	Crown Part No.	Draw No.	Other Information
	JACK PANEL ASSEMBLY	41256		
	Plate, jack, IC-150	3349	1	With 22 jacks mounted
	Lug, solder, 505, #8 hole	2935	2	One soldered onto jack plate; one over binding post screw next to hex nut
	Screw, 8-32 x 1/8 THP CHR	2155	3	Fastens end of jack plate
	Binding post, 220, blk	3245	4	Fastens end of jack plate
	Washer, star, #8 internal	1951	5	Use over 2155 screw
	Nut, hex, 8-32 CAD	1986	6	Use over 3245 binding post

FIGURE 6-16. JACK PANEL ASSY., 41256

SECTION 7
APPLICATION NOTES

GENERAL

Application notes will be published periodically and distributed to owners of CROWN equipment for insertion in the service manual.

Information will be distributed concerning component changes,

new accessories, special applications, modifications to equipment and any other technical data CROWN considers significant to help you use and maintain your equipment in optimum operating condition.

APPLICATION NOTE #1

SUBJECT: Replacement of H.H. Hilton Tantalum Capacitors in 1 MFD, 4 MFD and 6.8 MFD Values

Due to an excessive failure rate in the IC-150 and Logic Board, subject capacitors (all silver with one end red), will be replaced as follows:

1. Use CPN 1750 to replace all 1 MFD capacitors found on the Logic Board and in the IC-150 (2 per channel).
2. Use CPN 3337 to replace all 4 MFD capacitors found on the IC-150 Phono PC Board (2 per channel), and three on the Logic Board. **Always** replace C21, C22 and C24 on either Logic Board L1 or L2 with CPN 3337 as part of the "standard update procedure". The same applies to the IC-150 Phono PC Board, particularly C12.
3. No 6.8 MFD values are found in the IC-150.

**SUBJECT: Replacement Kit (CPN 41236) for
IC-150 Volume Control (R24)**

Early IC-150 Stereo Control Units (SN 100 to approximately 950) used the CPN 3237 Volume Control (R24) with matching components.

The replacement kit contains the new R24 and associated components shown in the chart below. All old components **must** be replaced with the new values for proper operation of the new Volume Control (CPN 3422).

REFERENCE DESIGNATION	OLD COMPONENTS	REPLACEMENT KIT	
		VALUES	CPN
R24	3237		3422
C7	.039	.022	2963
R7	15K	22K	3302
R6	20K	30K	2298
C5	.015	.022	2963
R5	15K	5.6K	3220
C4	.015	.022	2963
R3	27K	12K	2878
C3	.039	.022	2963
R2	27K	39K	2879

After R24 is replaced, it is necessary to perform the tracking test and adjustment described in paragraph 5.7.3 to insure the new Volume Control is performing properly.

SUBJECT: Input Level Controls for System Power Amplifiers

Your CROWN IC-150 Stereo Control Console is designed to match a wide range of power amplifiers with varying sensitivities and loudspeakers with efficiencies of 30% down to 0.5% — providing the associated power amplifiers incorporate INPUT LEVEL controls (as do all CROWN power amplifiers).

If the associated power amplifiers do not have input level con-

trols, your system may suffer from poor signal-to-noise, the IC-150 loudness compensation may sound boomy, and your speakers could be damaged by transients due to excessive system gain. **TURNING DOWN THE IC-150 VOLUME CONTROL CANNOT ELIMINATE THESE PROBLEMS!** CROWN recommends that input level controls (or pads) be installed at the power amplifier by a competent dealer technician.

INPUT LEVEL CONTROLS

(Potentiometer)
 $R_1 \approx 25K$

(Duplicate for other channel(s))

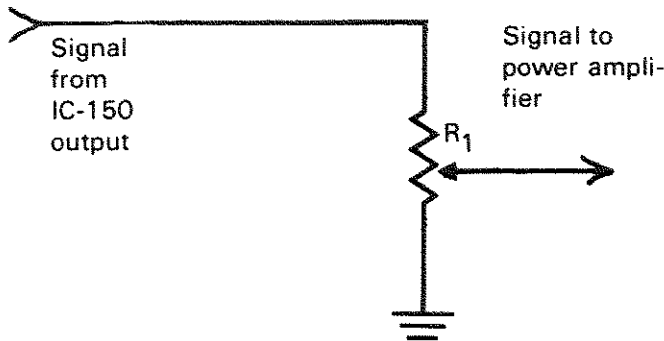

PADS

(Duplicate for other channel(s))

Ratio $\frac{R_1}{R_2}$ determined by system gain desired

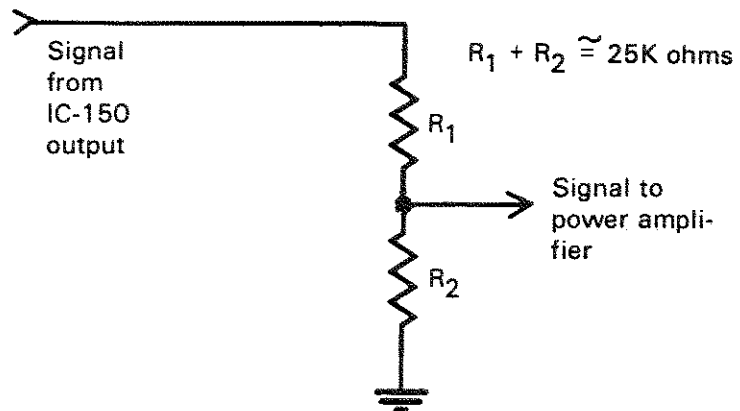

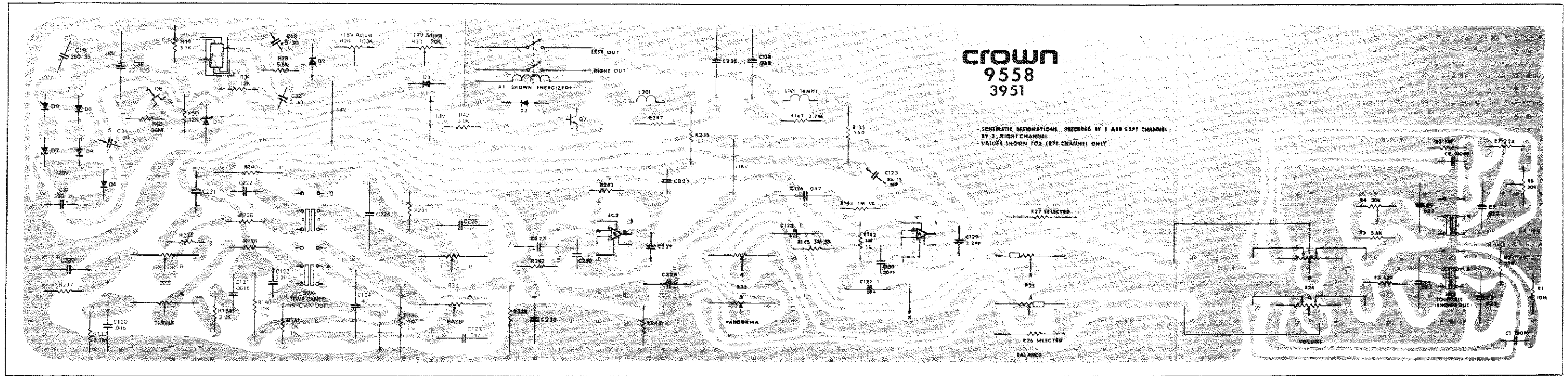

PARTS LIST: IC-150 STARTS S/N IC-15572

Schematic Designation	Description	Crown Part No.	Other Information	Schematic Designation	Description	Crown Part No.	Schematic Designation	Description	Crown Part No.	Other Information
	IC MAIN MODULE	41470	All parts except wire							
	IC-150 Main PC Board	9558								
	Capacitors:				Resistors:			Transistor:		
C1, 8	100 pf, mica	3410		R1, 8	10 megohm, .25W, 10%	3221	Q6	2N5459, NCH, JFET	3053	
C3, 4, 5, 7	.022 mfd, 200 V, filmatic	3977		R2	39K ohm, .25W, 10%	2879	Q7	2N3859A, selected	2961	
C19, 31	250 mfd, 35V, vertical	3787		R3, 31, 50	12K ohm, .25W, 10%	2878		Miscellaneous:		
C34, 18, 32	5 mfd, 30V, vertical	4026		R4, R30	20K ohm, vertical potentiometer	1712		Spacers	3210	Use on control shafts, inside front panel
C39	.22 mfd, 100V, filmatic	3218		R5, 29	5.6K ohm, .25W, 10%	3220		Lockwasher, star, 3/8", internal	2188	Use on control shafts, inside front panel
C40	.1 mfd, filmatic, mylar	2938	C40 from board to chassis	R6	30K ohm, vertical potentiometer	2298		Washer, control bright	2189	Use on control shafts, outside front panel
C120, 220	.015 mfd, 200V, filmatic	3288		R7	22K ohm, .25W, 10%	3302		Nut, bright, 3/8", NIC	1288	Use on control shafts, outside front panel
C121, 221	.0015 mfd, 200V, filmatic	3089		R24 (A & B)	VOLUME control	3422		Socket, IC, 8-pin	3451	Use on IC-1, IC-2, IC-3
C122, 222	3.9 pf, ceramic	2937		R25 (A & B)	BALANCE control	3238				
C123, 223	25 mfd, 15V, NP, vertical	3186		R136, 236	1K ohm, .25W, 10%	2627				
C124, 224	.47 mfd, 100V, filmatic	3995		R28	100K vertical potentiometer	1713				
C125, 126, 225, 226	.047 mfd, 200V, filmatic	3978		R31, 51	820 ohm, 5W, 10%	2580				
C127, 128, 227, 228	1 mfd, 30V, tantalum	1750		R32, (A&B&C)	PANORAMA control	3239				
C129, 229	2.2 pf, ceramic	3534		R33 (A&B); R39 (A&B)	TONE controls	3240				
C130, 230	20 pf, ceramic	3535		R44	3.3K, .25W, 10%	2629				
C138, 238	.068 mfd, 200V, filmatic	3190		R48	56 megohm, .25W, 10%	3536				
L101, 102	Coil: 12 mhy	1661		R141, 241	10K ohm, .25W, 10%	2631				
	Diodes:			R134, 234, 49	3.9K ohm, .25W, 10%	2630				
D2, 5	1N4003	2851		R135, 235	560 ohms, .5W, 10%	1030				
D3, 4, 6-9	1N4148	3181		R137, 147, 237, 247	2.7 megohm, .25W, 10%	2634				
D10	1N961 B, 10V, Zener	3549		R138, 238	1K ohm, .5W, 1% film	3194				
	Integrated Circuit:			R140, 240	10K ohm, .5W, 1% film	2343				
IC1, 2	301 AN OP Ampl	3532		R142, 143, 242, 243	1 megohm, .25W, 5%	3198				
IC3	RC 4195 ON Dual	3825		R145, 245	2 megohm, .25W, 10%	3199				
K1	Relay: 5K ohm, DPDT, NC, reed	3496		SW4, 6	Switch: pushbutton	3226				

IC-150 UPDATE SCHEMATIC

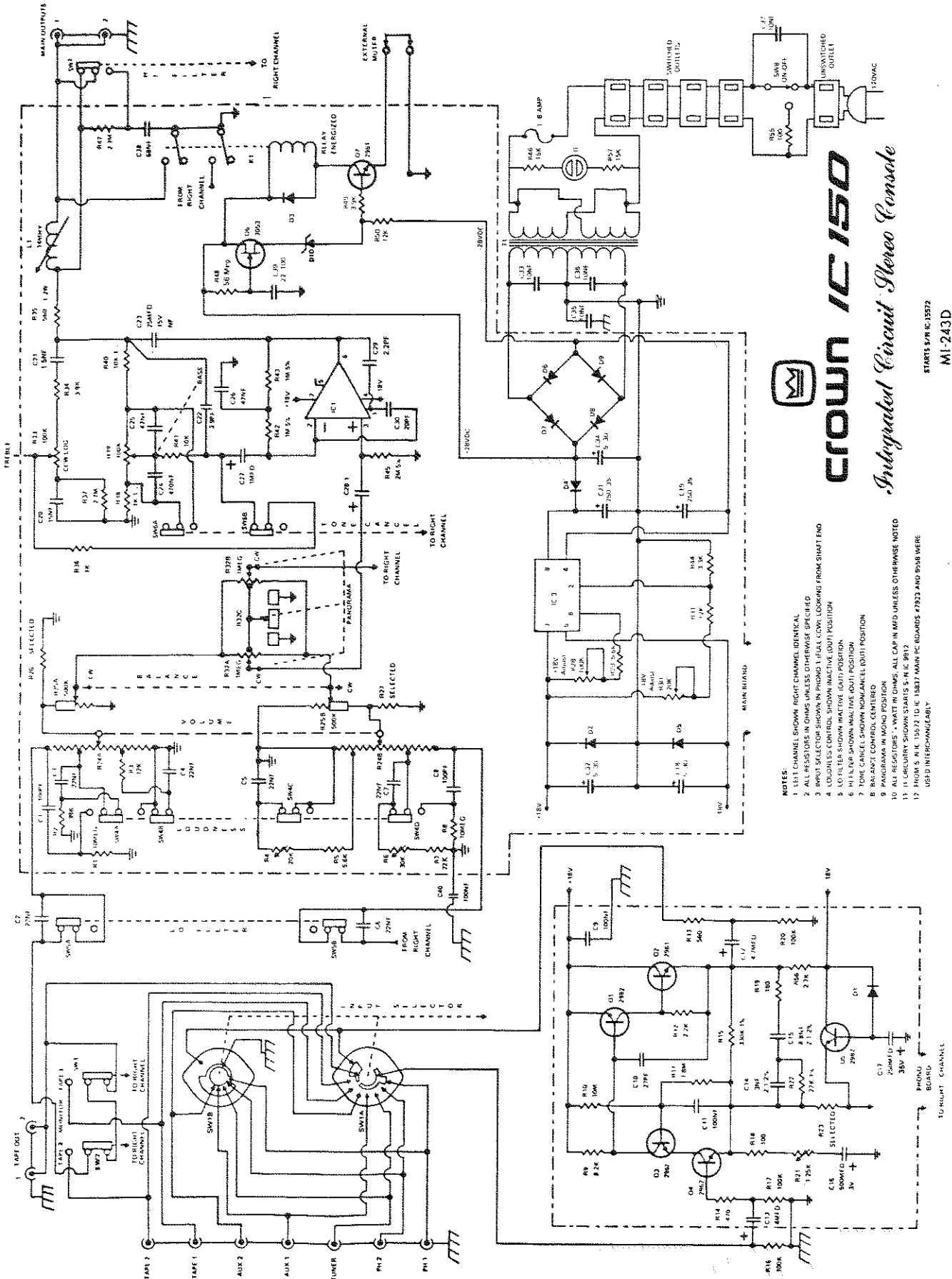

CROWN IC 150
Integrated Circuit Stereo Console

STARTS S/N IC-15572
 MI-243D

- NOTES:
1. LEFT CHANNEL SHOWN; RIGHT CHANNEL IDENTICAL.
 2. ALL RESISTORS IN OHMS UNLESS OTHERWISE SPECIFIED.
 3. IMPEDANCE SELECTOR IN PHONO 1, FULL LOW, LOOKING FROM SHIRT END.
 4. LOGIC SELECTOR SHOWN INACTIVE (DOT) POSITION.
 5. LOGIC 1-8 SHOWN INACTIVE (DOT) POSITION.
 6. LOGIC 9-16 SHOWN INACTIVE (DOT) POSITION.
 7. LOGIC 17-24 SHOWN INACTIVE (DOT) POSITION.
 8. BACK-SIDE COMPONENTS.
 9. PROGRAMS IN MONO POSITION.
 10. ALL RECTIFIERS - WAVE IN OHMS; ALL CAP IN MFD UNLESS OTHERWISE NOTED.
 11. IC CIRCUITRY SHOWN STARTS S-R IC P812.
 12. FROM S. N. 15072 TO IC-15887 MAIN PC BOARD; 47923 AND 9918 WERE USED INTERCHANGEABLY.

