

# DERBY

# Gelato Showcase

## DERBY GELATO - 26 3/8" DEEP

## DERBY PLUS GELATO - 32 1/2" DEEP

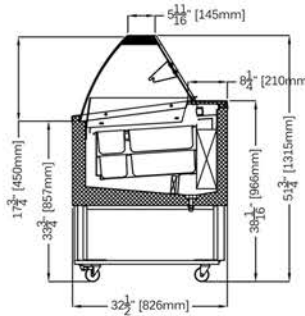
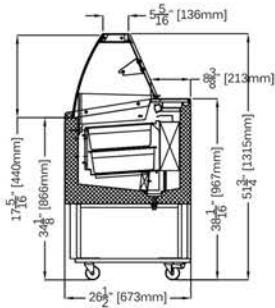

**DERBY GELATO  
DG7**

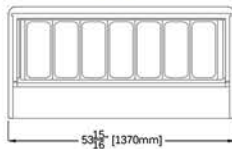

### DERBY PLUS GELATO OPTIONAL PAN CONFIGURATIONS:

**DPG8**

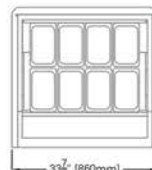

**4 LITER**

**DPG10**

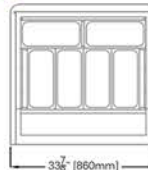

**5 LITER**

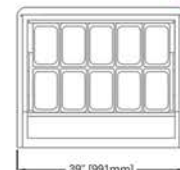

**4 LITER**

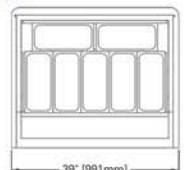

**5 LITER**

### STANDARD FEATURES

- Hermetic Compressor: high capacity refrigeration low consumption and low noise levels
- Automatic defrosting with reverse cycle defrost that doesn't affect product characteristics
- Ventilated forced circulation ensures maximum temperature uniformity
- Storage space with gelato pans
- Thermostat: digital control for temperature accuracy
- Climate Class: 86°F/60RH%
- Gas Refrigerant: R404A
- Wheels with brake
- 3 year compressor

### OPTIONS





- 5 Liter template
- Remote application
- Customize logo

Pan Sizes:
<b>4 Liter Pan</b> 10 1/8" x 6 1/8" x 5 7/8" (258mm x 156mm x 150mm)
<b>5 Liter Pan</b> 14 3/16" x 6 1/2" x 4 3/4" (360mm x 165mm x 120mm)

DERBY GELATO		
TECHNICAL FEATURES		MODEL
		DG7
External Dimensions (L-D-H)	Inches	53 15/16" - 26 1/2" - 51 3/4"
	MM	1370 - 673 - 1315
Crated Dimensions (L-D-H)	Inches	62" - 32 1/4" - 59 3/4"
	MM	1522 - 822 - 1518
5 Liter Pan capacity*	Pan Configuration	 7
Power Supply**	(V)	120V
Amperage	(A)	15A
Operating Temperature	*F	-5°F
Net Weights	Kg/Lb	135Kg / 297Lb
Crated Weights	Kg/Lb	148Kg / 325Lb

\* Pans not Included

\*\* 220V Available

DERBY PLUS GELATO			
TECHNICAL FEATURES		MODELS	
		DPG8	DPG10
External Dimensions (L-D-H)	Inches	33 7/8" - 32 1/2" - 51 3/4"	39" - 32 1/2" - 51 3/4"
	MM	860 - 826 - 1315	990 - 826 - 1315
Crated Dimensions (L-D-H)	Inches	39 3/4" - 38 1/2" - 59 3/4"	45" - 38 1/2" - 59 3/4"
	MM	1012 - 978 - 1518	1143 - 978 - 1518
4 Liter Pan capacity*	Pan Configuration	 8	 10
5 Liter Pan capacity*	Pan Configuration	 6	 7
Power Supply**	(V)	120V	120V
Amperage	(A)	15A	17A
Operating Temperature	*F	-5°F	-5°F
Net Weights	Kg/Lb	110Kgs / 242Lbs	125Kgs / 275Lbs
Crated Weights	Kg/Lb	118Kgs / 260Lbs	136Kgs / 299Lbs

\* Pans not Included

\*\* 220V Available



TurnKeyParlor.com  
equipment@turnkeyparlor.com  
877-817-5716

