

VECTOR WALL LIGHT

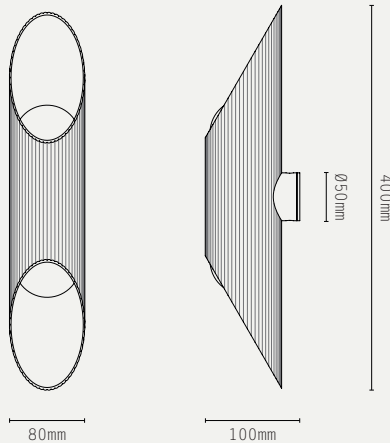

LIGHT SOURCE:

G9 LAMP BASE
(12W MAX LED ONLY)

LAMP SUPPLIED:

2 X G9 / 2700K / 3W /
250 LUMENS

DIMMABLE:

PHASE (MAINS) DIMMING (USING
SUPPLIED LAMP)

VOLTAGE:

240V AC (CLASS I)

CERTIFICATIONS:

CE / UKCA

MATERIALS:

BRASS, OPAL GLASS

WEIGHT:

1.5 KG (APPROX)





OPTIONAL ACCESSORIES:

EU JUNCTION BOX ADAPTOR

ADDITIONAL INFO:

DESIGNED BY WILL EARL 2020
MADE IN ENGLAND

METAL FINISHES:

-  ANTIQUE BRASS
-  BRONZE
-  SATIN BRASS
-  SATIN NICKEL

PRODUCT CODES:

VEC.WL1.AB - ANTIQUE BRASS
VEC.WL1.BZ - BRONZE
VEC.WL1.SB - SATIN BRASS
VEC.WL1.SN - SATIN NICKEL

VECTOR PENDANT

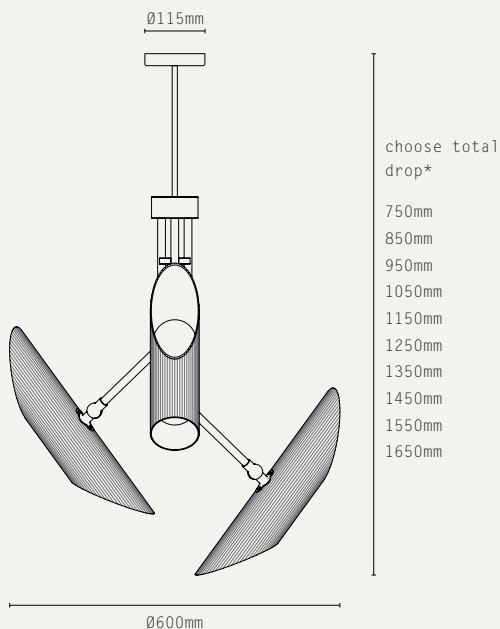

LIGHT SOURCE:

G9 LAMP BASE
(12W MAX LED ONLY)

LAMP SUPPLIED:

6 X G9 / 2700K / 3W /
250 LUMENS

DIMMABLE:

PHASE (MAINS) DIMMING (USING
SUPPLIED LAMP)

VOLTAGE:

240V AC (CLASS I)

CERTIFICATIONS:

CE / UKCA

MATERIALS:

BRASS, OPAL GLASS

WEIGHT:

12 KG (APPROX)





HANGING OPTIONS:

DROP ROD AT 100MM INCREMENTS

ADDITIONAL INFO:

DESIGNED BY WILL EARL 2020
MADE IN ENGLAND

METAL FINISHES:

-  ANTIQUE BRASS
-  BRONZE
-  SATIN BRASS
-  SATIN NICKEL

PRODUCT CODES:

- VEC.P3.AB - ANTIQUE BRASS
- VEC.P3.BZ - BRONZE
- VEC.P3.SB - SATIN BRASS
- VEC.P3.SN - SATIN NICKEL

VECTOR FLOOR LIGHT

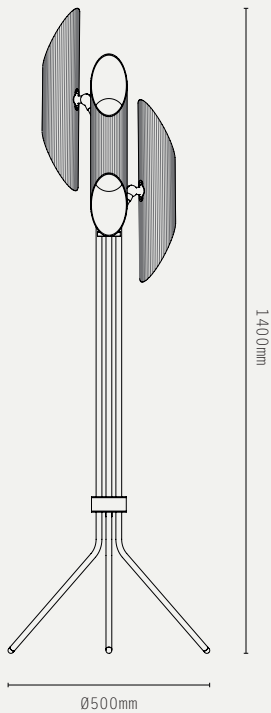

LIGHT SOURCE:

G9 LAMP BASE
(12W MAX LED ONLY)

LAMP SUPPLIED:

6 X G9 / 2700K / 3W /
250 LUMENS

VOLTAGE:

240V AC (CLASS I)

CERTIFICATIONS:

CE / UKCA

MATERIALS:

BRASS, OPAL GLASS

WEIGHT:

12 KG (APPROX)

FLEX:

2M COTTON BRAIDED FLEX WITH
INLINE FOOT SWITCH





OPTIONS / ACCESSORIES:

- 5A PLUG
- INLINE DIMMER

ADDITIONAL INFO:

DESIGNED BY WILL EARL 2020
MADE IN ENGLAND

METAL FINISHES:

-  ANTIQUE BRASS
-  BRONZE
-  SATIN BRASS
-  SATIN NICKEL

PRODUCT CODES:

- VEC.F3.AB - ANTIQUE BRASS
- VEC.F3.BZ - BRONZE
- VEC.F3.SB - SATIN BRASS
- VEC.F3.SN - SATIN NICKEL

- VEC.F3.AB.EU - ANTIQUE BRASS / EU PLUG
- VEC.F3.BZ.EU - BRONZE / EU PLUG
- VEC.F3.SB.EU - SATIN BRASS / EU PLUG
- VEC.F3.SN.EU - SATIN NICKEL / EU PLUG