

SPOT SWITCHED WALL LIGHT

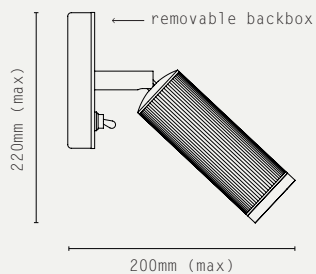
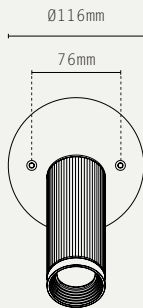

LIGHT SOURCE:

GU10 LAMP BASE
(12W MAX LED ONLY / 35MM MAX
LAMP DIAMETER)

LAMP SUPPLIED:

1 X GU10 MR11 LED / 2700K /
3.6W / 290 LUMENS / 36° BEAM

DIMMABLE:

ON/OFF TOGGLE SWITCH ON
BACKPLATE

VOLTAGE:

240V AC (CLASS I)

CERTIFICATIONS:

CE / UKCA

MATERIALS:

BRASS





WEIGHT:

1.1 KG (APPROX)

ADDITIONAL INFO:

DESIGNED BY WILL EARL 2019
MADE IN ENGLAND

METAL FINISHES:

-  ANTIQUE BRASS
-  BRONZE
-  SATIN BRASS
-  SATIN NICKEL

PRODUCT CODES:

SP.W1.AB - ANTIQUE BRASS
SP.W1.BZ - BRONZE
SP.W1.SB - SATIN BRASS
SP.W1.SN - SATIN NICKEL

SPOT UNSWITCHED WALL LIGHT

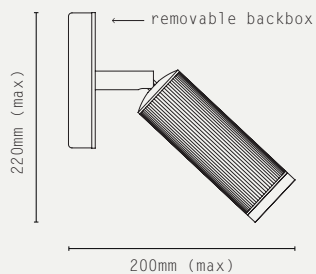
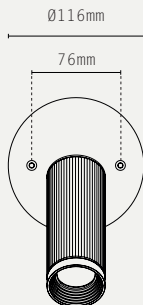

LIGHT SOURCE:

GU10 LAMP BASE
(12W MAX LED ONLY / 35MM MAX
LAMP DIAMETER)

LAMP SUPPLIED:

1 X GU10 MR11 LED / 2700K /
3.6W / 290 LUMENS / 36° BEAM

DIMMABLE:

PHASE (MAINS) DIMMING (USING
SUPPLIED LAMP)

VOLTAGE:

240V AC (CLASS I)

CERTIFICATIONS:

CE / UKCA

MATERIALS:

BRASS

WEIGHT:





1.1 KG (APPROX)

ADDITIONAL INFO:

DESIGNED BY WILL EARL 2019

MADE IN ENGLAND

METAL FINISHES:

-  ANTIQUE BRASS
-  BRONZE
-  SATIN BRASS
-  SATIN NICKEL

PRODUCT CODES:

- SP.W1.NS.AB - ANTIQUE BRASS
- SP.W1.NS.BZ - BRONZE
- SP.W1.NS.SB - SATIN BRASS
- SP.W1.NS.SN - SATIN NICKEL

SPOT WALL RAIL LIGHT - DOUBLE

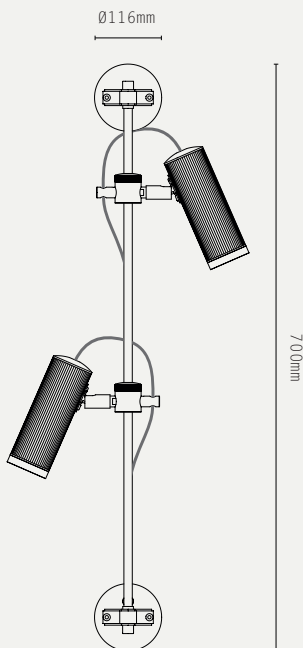

LIGHT SOURCE:

GU10 LAMP BASE
(12W MAX LED ONLY / 35MM MAX
LAMP DIAMETER)

LAMP SUPPLIED:

2 X GU10 MR11 LED / 2700K /
3.6W / 290 LUMENS / 36° BEAM

DIMMABLE:

PHASE (MAINS) DIMMING (USING
SUPPLIED LAMP)

VOLTAGE:

240V AC (CLASS I)

CERTIFICATIONS:

CE / UKCA

MATERIALS:

BRASS

WEIGHT:

2.2 KG (APPROX)

FLEX:

COTTON BRAIDED FLEX

OPTIONAL ACCESSORIES:

- DEEP MOUNTING BACKBOX
- EU JUNCTION BOX ADAPTOR

ADDITIONAL INFO:

DESIGNED BY WILL EARL 2019
MADE IN ENGLAND

METAL FINISHES:

-  ANTIQUE BRASS
-  SATIN BRASS
-  SATIN NICKEL

PRODUCT CODES:

SP.WR600.AB - ANTIQUE BRASS
SP.WR600.SB - SATIN BRASS
SP.WR600.SN - SATIN NICKEL

SPOT WALL RAIL LIGHT - SINGLE

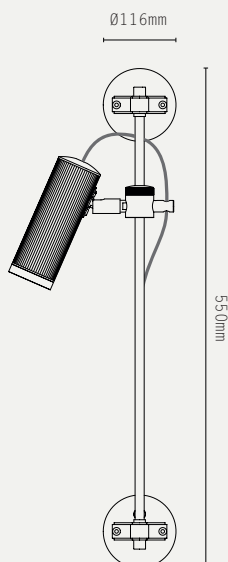

LIGHT SOURCE:

GU10 LAMP BASE
(12W MAX LED ONLY / 35MM MAX
LAMP DIAMETER)

LAMP SUPPLIED:

1 X GU10 MR11 LED / 2700K /
3.6W / 290 LUMENS / 36° BEAM

DIMMABLE:

PHASE (MAINS) DIMMING (USING
SUPPLIED LAMP)

VOLTAGE:

240V AC (CLASS I)

CERTIFICATIONS:

CE / UKCA

MATERIALS:

BRASS

WEIGHT:

1.9 KG (APPROX)

FLEX:

COTTON BRAIDED FLEX

OPTIONAL ACCESSORIES:

- DEEP MOUNTING BACKBOX
- EU JUNCTION BOX ADAPTOR

ADDITIONAL INFO:

DESIGNED BY WILL EARL 2019
MADE IN ENGLAND

METAL FINISHES:

-  ANTIQUE BRASS
-  SATIN BRASS
-  SATIN NICKEL

PRODUCT CODES:

SP.WR400.AB - ANTIQUE BRASS
SP.WR400.SB - SATIN BRASS
SP.WR400.SN - SATIN NICKEL

SPOT SINGLE CEILING LIGHT

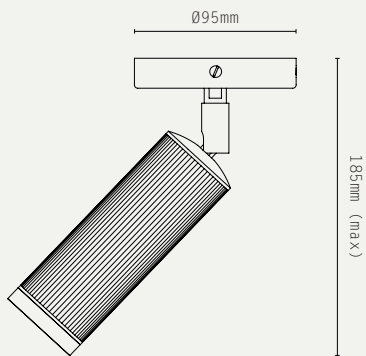

LIGHT SOURCE:

GU10 LAMP BASE
(12W MAX LED ONLY / 35MM MAX
LAMP DIAMETER)

LAMP SUPPLIED:

1 X GU10 MR11 LED / 2700K /
3.6W / 290 LUMENS / 36° BEAM

DIMMABLE:

PHASE (MAINS) DIMMING (USING
SUPPLIED LAMP)

VOLTAGE:

240V AC (CLASS I)

CERTIFICATIONS:

CE / UKCA

MATERIALS:

BRASS





WEIGHT:

1.1 KG (APPROX)

ADDITIONAL INFO:

DESIGNED BY WILL EARL 2019
MADE IN ENGLAND

METAL FINISHES:

-  ANTIQUE BRASS
-  BRONZE
-  SATIN BRASS
-  SATIN NICKEL

PRODUCT CODES:

- SP.1.AB - ANTIQUE BRASS
- SP.1.BZ - BRONZE
- SP.1.SB - SATIN BRASS
- SP.1.SN - SATIN NICKEL

SPOT DOUBLE CEILING LIGHT

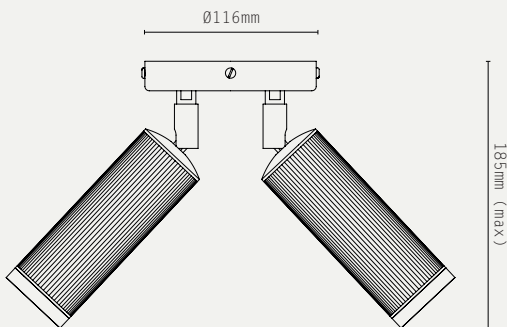

LIGHT SOURCE:

GU10 LAMP BASE
(12W MAX LED ONLY / 35MM MAX
LAMP DIAMETER)

LAMP SUPPLIED:

2 X GU10 MR11 LED / 2700K /
3.6W / 290 LUMENS / 36° BEAM

DIMMABLE:

PHASE (MAINS) DIMMING (USING
SUPPLIED LAMP)

VOLTAGE:

240V AC (CLASS I)

CERTIFICATIONS:

CE / UKCA

MATERIALS:

BRASS

WEIGHT:





1.5 KG (APPROX)

ADDITIONAL INFO:

DESIGNED BY WILL EARL 2019

MADE IN ENGLAND

METAL FINISHES:

-  ANTIQUE BRASS
-  BRONZE
-  SATIN BRASS
-  SATIN NICKEL

PRODUCT CODES:

- SP.2.AB - ANTIQUE BRASS
- SP.2.BZ - BRONZE
- SP.2.SB - SATIN BRASS
- SP.2.SN - SATIN NICKEL

SPOT TRIPLE CEILING LIGHT

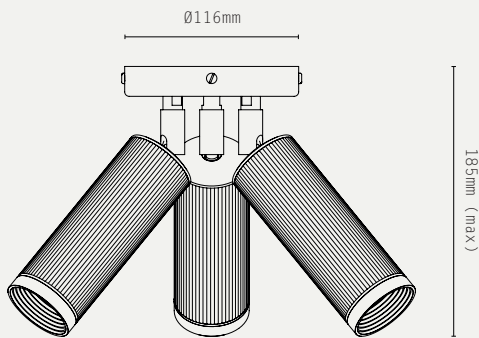

LIGHT SOURCE:

GU10 LAMP BASE
(12W MAX LED ONLY / 35MM MAX
LAMP DIAMETER)

LAMP SUPPLIED:

3 X GU10 MR11 LED / 2700K /
3.6W / 290 LUMENS / 36° BEAM

DIMMABLE:

PHASE (MAINS) DIMMING (USING
SUPPLIED LAMP)

VOLTAGE:

240V AC (CLASS I)

CERTIFICATIONS:

CE / UKCA

MATERIALS:

BRASS

WEIGHT:





2 KG (APPROX)

ADDITIONAL INFO:

DESIGNED BY WILL EARL 2019

MADE IN ENGLAND

METAL FINISHES:

-  ANTIQUE BRASS
-  BRONZE
-  SATIN BRASS
-  SATIN NICKEL

PRODUCT CODES:

- SP.3.AB - ANTIQUE BRASS
- SP.3.BZ - BRONZE
- SP.3.SB - SATIN BRASS
- SP.3.SN - SATIN NICKEL

SPOT PENDANT - 6 SPOT

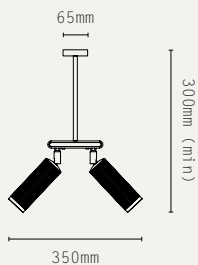
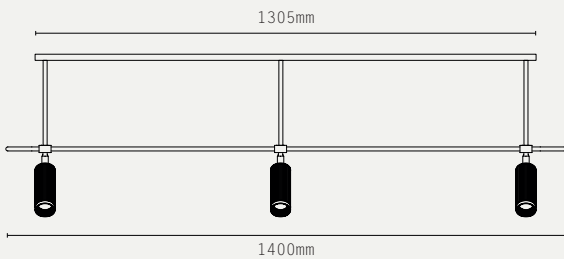

LIGHT SOURCE:

GU10 LAMP BASE
(12W MAX LED ONLY / 35MM MAX
LAMP DIAMETER)

LAMP SUPPLIED:

6 X GU10 MR11 LED / 2700K /
3.6W / 290 LUMENS / 36° BEAM

DIMMABLE:

PHASE (MAINS) DIMMING (USING
SUPPLIED LAMP)

VOLTAGE:

240V AC (CLASS I)

CERTIFICATIONS:

CE / UKCA

MATERIALS:

BRASS

WEIGHT:

10.5 KG (APPROX)





HANGING OPTIONS:

- 2.5M SUSPENSION WIRE WITH
BRAIDED CABLE
- DROP ROD AT 100MM INCREMENTS
(SPECIFY DROP WHEN ORDERING)

ADDITIONAL INFO:

- CEILING CANOPY IN BLACK
POWDER-COATED STEEL
- DESIGNED BY WILL EARL 2019
- MADE IN ENGLAND

METAL FINISHES:

-  ANTIQUE BRASS
-  BRONZE
-  SATIN BRASS
-  SATIN NICKEL

PRODUCT CODES:

- SP.P6.AB - ANTIQUE BRASS
- SP.P6.BZ - BRONZE
- SP.P6.SB - SATIN BRASS
- SP.P6.SN - SATIN NICKEL

- SP.P6.R.AB - ANTIQUE BRASS / DROP ROD
- SP.P6.R.BZ - BRONZE / DROP ROD
- SP.P6.R.SB - SATIN BRASS / DROP ROD
- SP.P6.R.SN - SATIN NICKEL / DROP ROD

SPOT PENDANT - 8 SPOT

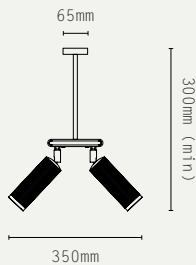
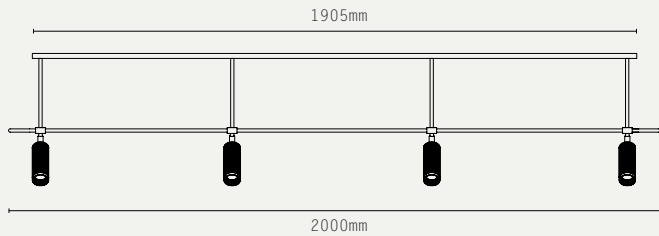

LIGHT SOURCE:

GU10 LAMP BASE
(12W MAX LED ONLY / 35MM MAX
LAMP DIAMETER)

LAMP SUPPLIED:

8 X GU10 MR11 LED / 2700K /
3.6W / 290 LUMENS / 36° BEAM

DIMMABLE:

PHASE (MAINS) DIMMING (USING
SUPPLIED LAMP)

VOLTAGE:

240V AC (CLASS I)

CERTIFICATIONS:

CE / UKCA

MATERIALS:

BRASS

WEIGHT:

12 KG (APPROX)





HANGING OPTIONS:

- 2.5M SUSPENSION WIRE WITH
BRAIDED CABLE
- DROP ROD AT 100MM INCREMENTS
(SPECIFY DROP WHEN ORDERING)

ADDITIONAL INFO:

- CEILING CANOPY IN BLACK
POWDER-COATED STEEL
- DESIGNED BY WILL EARL 2019
- MADE IN ENGLAND

METAL FINISHES:

-  ANTIQUE BRASS
-  BRONZE
-  SATIN BRASS
-  SATIN NICKEL

PRODUCT CODES:

- SP.P8.AB - ANTIQUE BRASS
- SP.P8.BZ - BRONZE
- SP.P8.SB - SATIN BRASS
- SP.P8.SN - SATIN NICKEL

- SP.P8.R.AB - ANTIQUE BRASS / DROP ROD
- SP.P8.R.BZ - BRONZE / DROP ROD
- SP.P8.R.SB - SATIN BRASS / DROP ROD
- SP.P8.R.SN - SATIN NICKEL / DROP ROD

SPOT DESK LIGHT



LIGHT SOURCE:

GU10 LAMP BASE
(12W MAX LED ONLY / 35MM MAX
LAMP DIAMETER)

LAMP SUPPLIED:

1 X GU10 MR11 LED / 2700K /
3.6W / 290 LUMENS / 36° BEAM

VOLTAGE:

240V AC (CLASS II)

CERTIFICATIONS:

CE / UKCA

MATERIALS:

BRASS, NATURAL STONE

WEIGHT:

3 KG (APPROX)

FLEX:

2M COTTON BRAIDED FLEX WITH
INLINE ON/OFF SWITCH

OPTIONS / ACCESSORIES:

- 5A PLUG
- DESK FIXING
- INLINE DIMMER SWITCH

ADDITIONAL INFO:

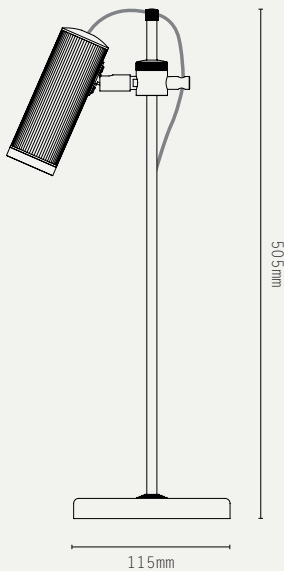

DESIGNED BY WILL EARL 2019
MADE IN ENGLAND



METAL FINISHES:

-  ANTIQUE BRASS
-  SATIN BRASS
-  SATIN NICKEL

STONE OPTIONS:

-  BLACK MARBLE
-  TRAVERTINE

PRODUCT CODES:

SP.TB1.AB.BM - ANTIQUE BRASS / BLACK MARBLE / BLACK FLEX
SP.TB1.SB.BM - SATIN BRASS / BLACK MARBLE / BLACK FLEX
SP.TB1.SN.BM - SATIN NICKEL / BLACK MARBLE / BLACK FLEX
SP.TB1.AB.TV - ANTIQUE BRASS / TRAVERTINE / LINEN FLEX
SP.TB1.SB.TV - SATIN BRASS / TRAVERTINE / LINEN FLEX
SP.TB1.SN.TV - SATIN NICKEL / TRAVERTINE / LINEN FLEX

SP.TB1.AB.BM.EU - ANTIQUE BRASS / BLACK MARBLE / BLACK FLEX / EU PLUG
SP.TB1.SB.BM.EU - SATIN BRASS / BLACK MARBLE / BLACK FLEX / EU PLUG
SP.TB1.SN.BM.EU - SATIN NICKEL / BLACK MARBLE / BLACK FLEX / EU PLUG
SP.TB1.AB.TV.EU - ANTIQUE BRASS / TRAVERTINE / LINEN FLEX / EU PLUG
SP.TB1.SB.TV.EU - SATIN BRASS / TRAVERTINE / LINEN FLEX / EU PLUG
SP.TB1.SN.TV.EU - SATIN NICKEL / TRAVERTINE / LINEN FLEX / EU PLUG

SPOT FLOOR LIGHT

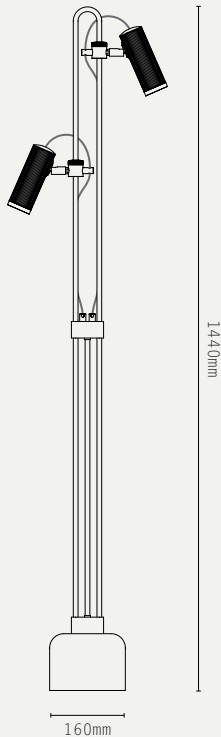

LIGHT SOURCE:

GU10 LAMP BASE
(12W MAX LED ONLY / 35MM MAX
LAMP DIAMETER)

LAMP SUPPLIED:

2 X GU10 MR11 LED / 2700K /
3.6W / 290 LUMENS / 36° BEAM

VOLTAGE:

240V AC (CLASS I)

CERTIFICATIONS:

CE / UKCA

MATERIALS:

BRASS, NATURAL STONE

WEIGHT:

10 KG (APPROX)

FLEX:

2M COTTON BRAIDED FLEX WITH
INLINE FOOT SWITCH

OPTIONS / ACCESSORIES:

- 5A PLUG
- INLINE DIMMER



ADDITIONAL INFO:

DESIGNED BY WILL EARL 2019
MADE IN ENGLAND

METAL FINISHES:

-  ANTIQUE BRASS
-  SATIN BRASS
-  SATIN NICKEL

STONE OPTIONS:

-  BLACK MARBLE
-  TRAVERTINE

PRODUCT CODES:

SP.FL1.AB.BM - ANTIQUE BRASS / BLACK MARBLE / BLACK FLEX
 SP.FL1.SB.BM - SATIN BRASS / BLACK MARBLE / BLACK FLEX
 SP.FL1.SN.BM - SATIN NICKEL / BLACK MARBLE / BLACK FLEX
 SP.FL1.AB.TV - ANTIQUE BRASS / TRAVERTINE / LINEN FLEX
 SP.FL1.SB.TV - SATIN BRASS / TRAVERTINE / LINEN FLEX
 SP.FL1.SN.TV - SATIN NICKEL / TRAVERTINE / LINEN FLEX

SP.FL1.AB.BM.EU - ANTIQUE BRASS / BLACK MARBLE / BLACK FLEX / EU PLUG
 SP.FL1.SB.BM.EU - SATIN BRASS / BLACK MARBLE / BLACK FLEX / EU PLUG
 SP.FL1.SN.BM.EU - SATIN NICKEL / BLACK MARBLE / BLACK FLEX / EU PLUG
 SP.FL1.AB.TV.EU - ANTIQUE BRASS / TRAVERTINE / LINEN FLEX / EU PLUG
 SP.FL1.SB.TV.EU - SATIN BRASS / TRAVERTINE / LINEN FLEX / EU PLUG
 SP.FL1.SN.TV.EU - SATIN NICKEL / TRAVERTINE / LINEN FLEX / EU PLUG